

PANAMA 2 DOOR WARDROBE ASSEMBLY INSTRUCTIONS



IMPORTANT PLEASE READ BEFORE YOU CONTINUE FURTHER **FOR DOMESTIC USE ONLY** **CARE AND MAINTENANCE**

After unpacking this product please keep the original packaging in case it needs to be returned for any reason.

- Please ensure all fittings and parts are present before commencing with assembly.
- We recommend that you lay a blanket or sheet on the floor to avoid damage to both your floor and the product.
- We strongly recommend that you keep children away from your work area.
- Assemble this product as close to its final position as possible.
- Never drag or push products as this could cause damage to the joints making it inferior.
- Do not place this product next to a radiator or in direct sunlight.
- Wood is a natural product and may expand if subjected to damp and may shrink or crack if subjected to heat. Therefore it is recommended that room temperature is maintained, with no sudden temperature fluctuations.
- Make sure any spillage is wiped off immediately.
- Do not place hot or chilled items directly on to the surface, use a place mat or marking will occur.
- For general cleaning use a duster, and do not use detergents of any kind. However, the surface will need to be retreated from time to time. This can be done by using block wax (unperfumed) and rubbing it over the whole item.
- From time to time it may be necessary to tighten fittings, regular inspections should be carried out.

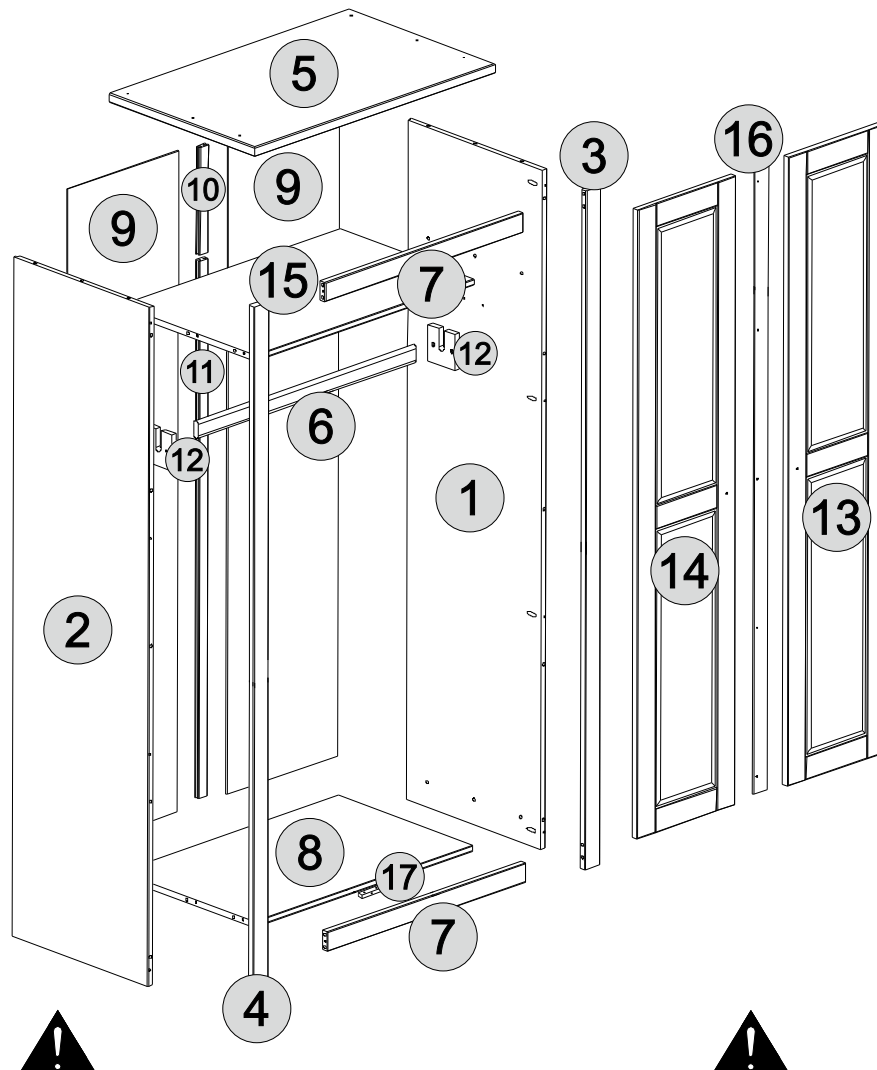









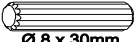

* Use of power tools to assemble this product will invalidate any claim and damage this product making it unsafe !!!
* Please assemble on a clean soft surface to avoid damage.

* Please check contents and read the instructions before commencing assembly.
* Assemble this product following the enclosed instructions carefully.
* Please take care to avoid damaging panels during assembly.

PARTS LIST

Part Number	Part Code	Part Description	Quantity	Carton
1	S100-101-039-MY1-01	Right Side Panel	1	1/2
2	S100-101-039-MY1-02	Left Side Panel	1	1/2
3	S100-101-039-MY1-03	Right Front Upright	1	1/2
4	S100-101-039-MY1-04	Left Front Upright	1	1/2
5	S100-101-039-MY1-05	Top Panel	1	2/2
6	S100-101-039-MY1-06	Hanger	1	2/2
7	S100-101-039-MY1-07	Front Crossbeam	2	1/2
8	S100-101-039-MY1-08	Base	1	2/2
9	S100-101-039-MY1-09	Back Panel	2	1/2
10	S100-101-039-MY1-10	Back Panel Strip (Upper)	1	1/2
11	S100-101-039-MY1-11	Back Panel Strip (Lower)	1	1/2
12	S100-101-039-MY1-12	Hanging Rail Support	2	2/2
13	S100-101-039-MY1-13	Right Door	1	1/2
14	S100-101-039-MY1-14	Left Door	1	1/2
15	S100-101-039-MY1-15	Fixed Shelf	1	2/2
16	S100-101-039-MY1-16	Door Strip	1	1/2
17	S100-101-039-MY1-17	Support Block	1	2/2

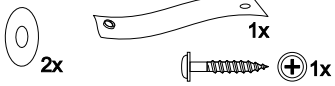
FITTINGS

A	 Ø 8 x 30mm	36	G	 M4 x 25mm	02
B	 Ø 4,0 x 40mm	06	H	 Right	03
C	 Ø 3,5 x 30mm	31	I	 Left	03
D	 Ø 3,0 x 16mm	45	J	 10x10mm	46
E		04	K	 2x 1x 1x	01
F		02			

TOOLS REQUIRED

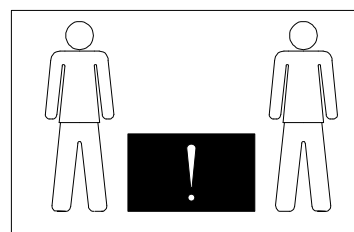
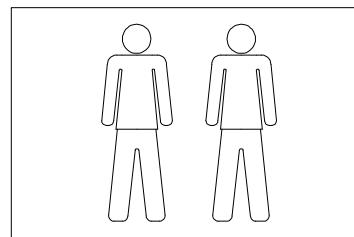
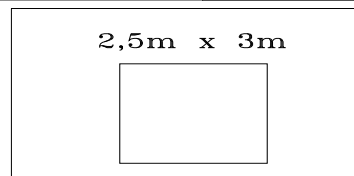
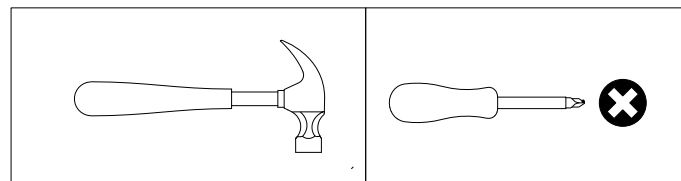



STEP 1

PARTS REQUIRED

1 - RIGHT SIDE PANEL	x1
2 - LEFT SIDE PANEL	x1
12 - HANGING RAIL SUPPORT	x2

HARDWARE REQUIRED

A		16
C		04

TOOLS REQUIRED

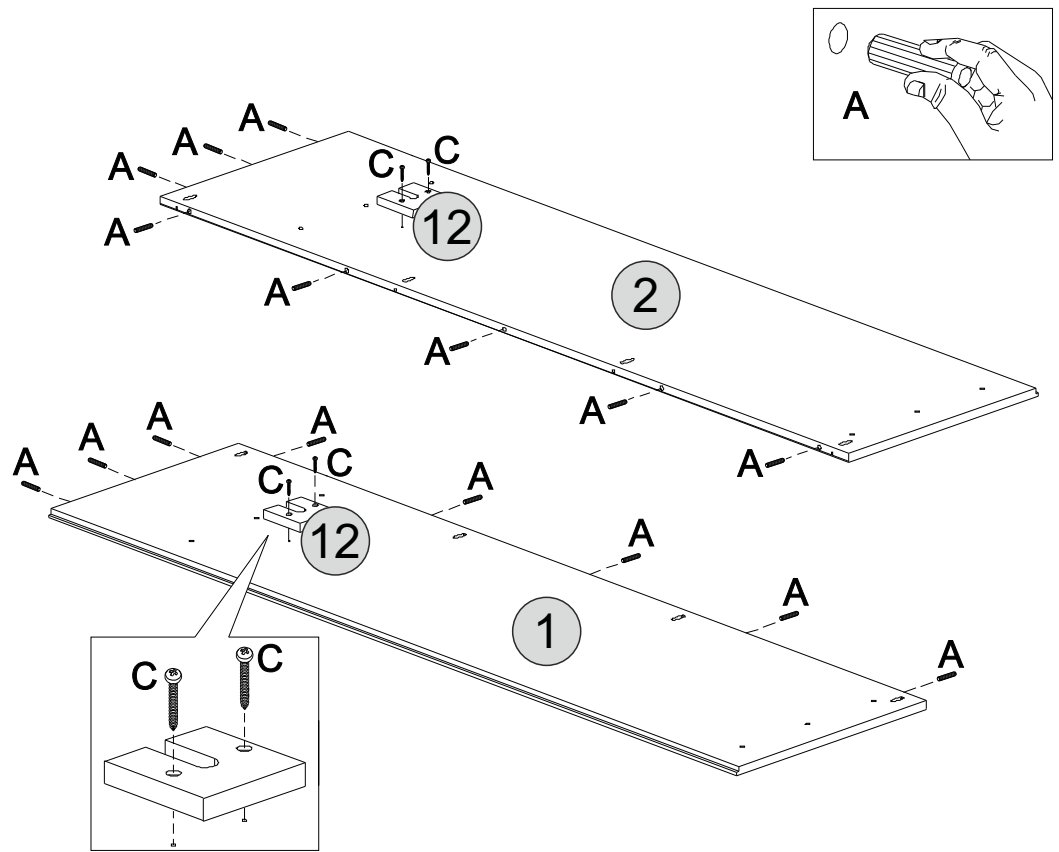
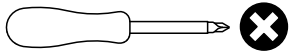

!
Please assemble on a clean soft surface to avoid damage.

STEP 2

PARTS REQUIRED

7 - FRONT CROSSBEAM	x2
8 - BASE	x1
15 - FIXED SHELF	x1

HARDWARE REQUIRED

A		20
---	---	----

TOOLS REQUIRED

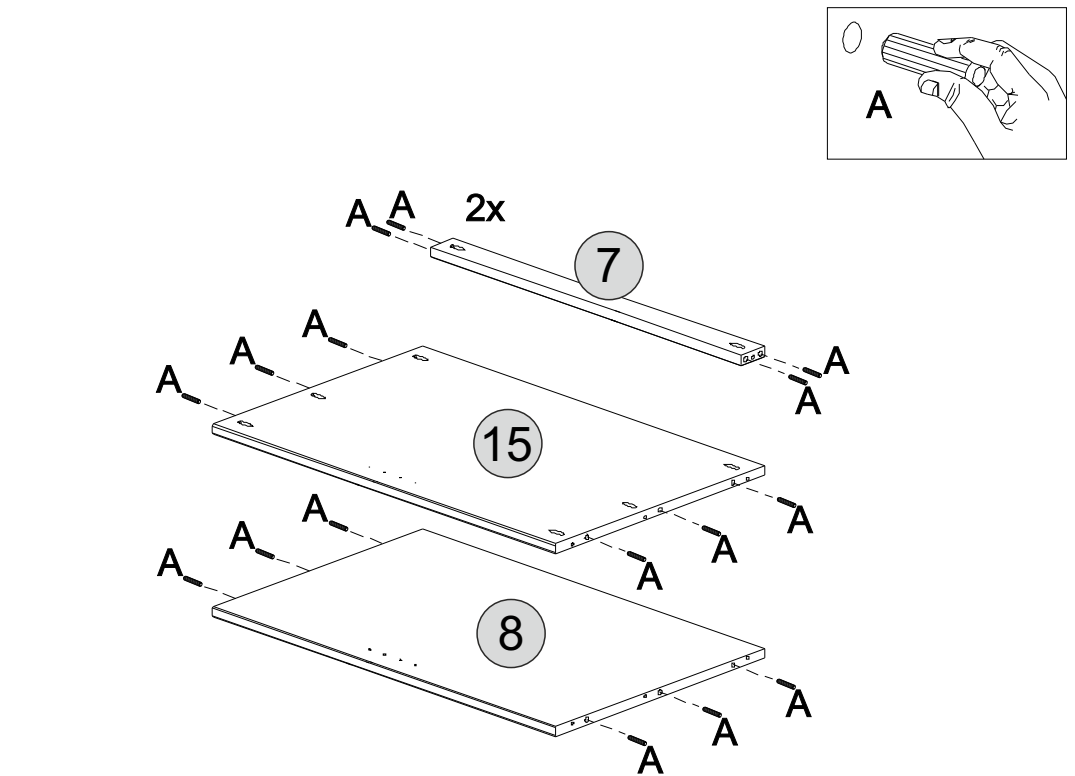



!
Please assemble on a clean soft surface to avoid damage.

STEP 3

PARTS REQUIRED

8 - BASE	x1
15 - FIXED SHELF	x1
17 - SUPPORT BLOCK	x1

HARDWARE REQUIRED

C	 Ø 3,5 x 30mm	02
D	 Ø 3,0 x 16mm	08
E		04

TOOLS REQUIRED

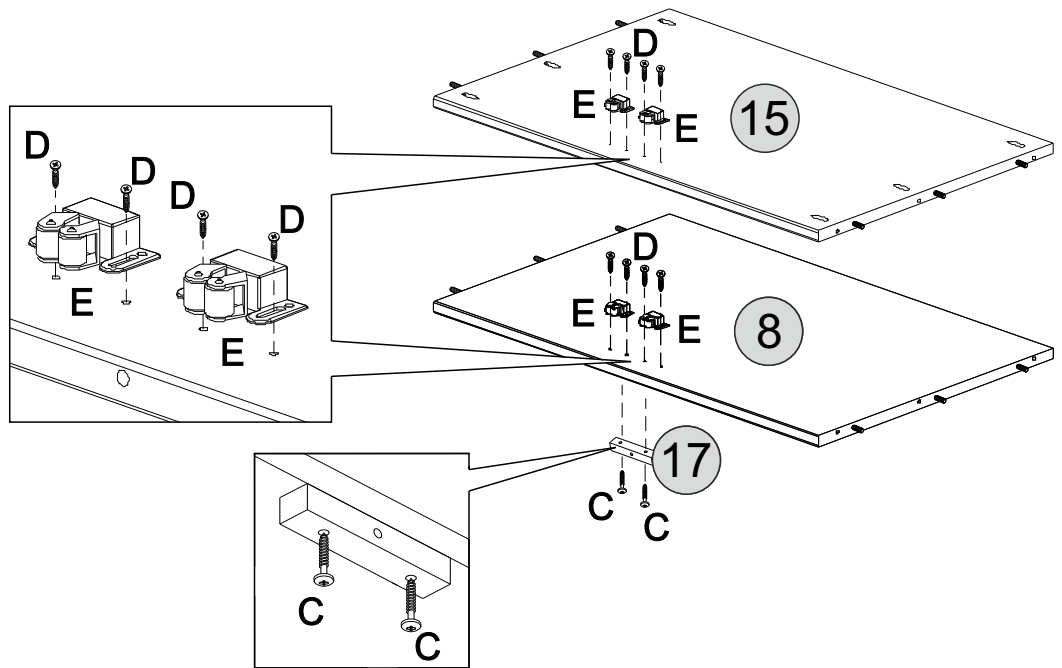
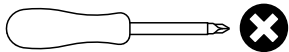

!
Please assemble on a clean soft surface to avoid damage.

STEP 4

PARTS REQUIRED

1 - RIGHT SIDE PANEL	x1
2 - LEFT SIDE PANEL	x1
3 - RIGHT FRONT UPRIGHT	x1
4 - LEFT FRONT UPRIGHT	x1

HARDWARE REQUIRED

C	 Ø 3,5 x 30mm	08
---	--	----

TOOLS REQUIRED

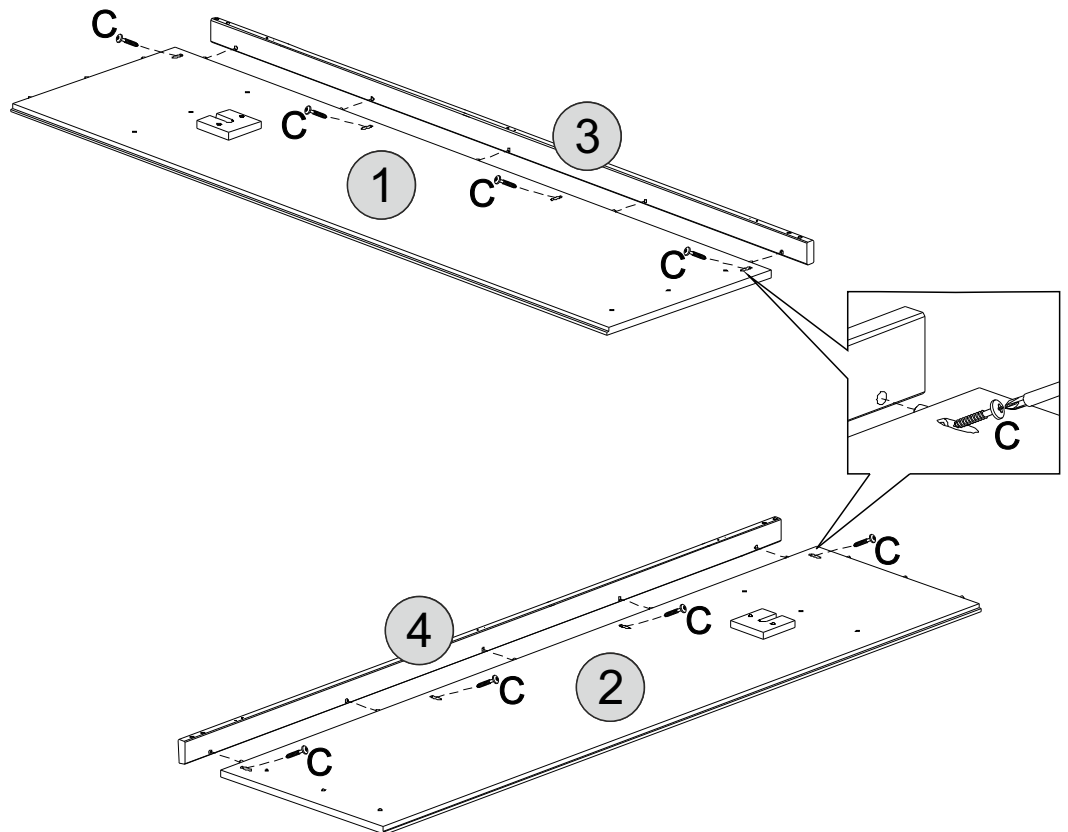
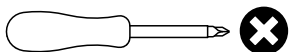

!
Please assemble on a clean soft surface to avoid damage.

STEP 5

PARTS REQUIRED

2 - LEFT SIDE PANEL x1

8 - BASE x1

15 - FIXED SHELF x1

HARDWARE REQUIRED

C  06
Ø 3,5 x 30mm

TOOLS REQUIRED

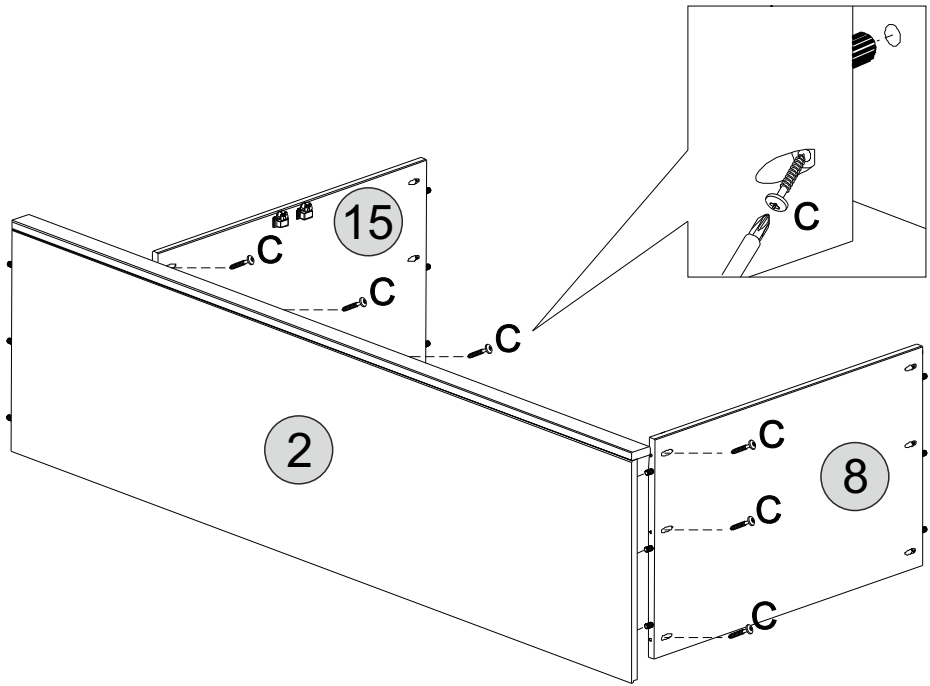
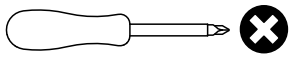

Please assemble on a clean soft surface to avoid damage.

STEP 6

PARTS REQUIRED

1 - RIGHT SIDE PANEL x1

7 - FRONT CROSSBEAM x2

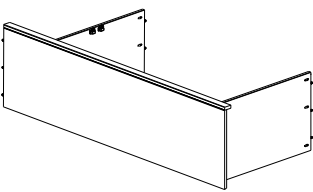

HARDWARE REQUIRED

C  11
Ø 3,5 x 30mm

TOOLS REQUIRED

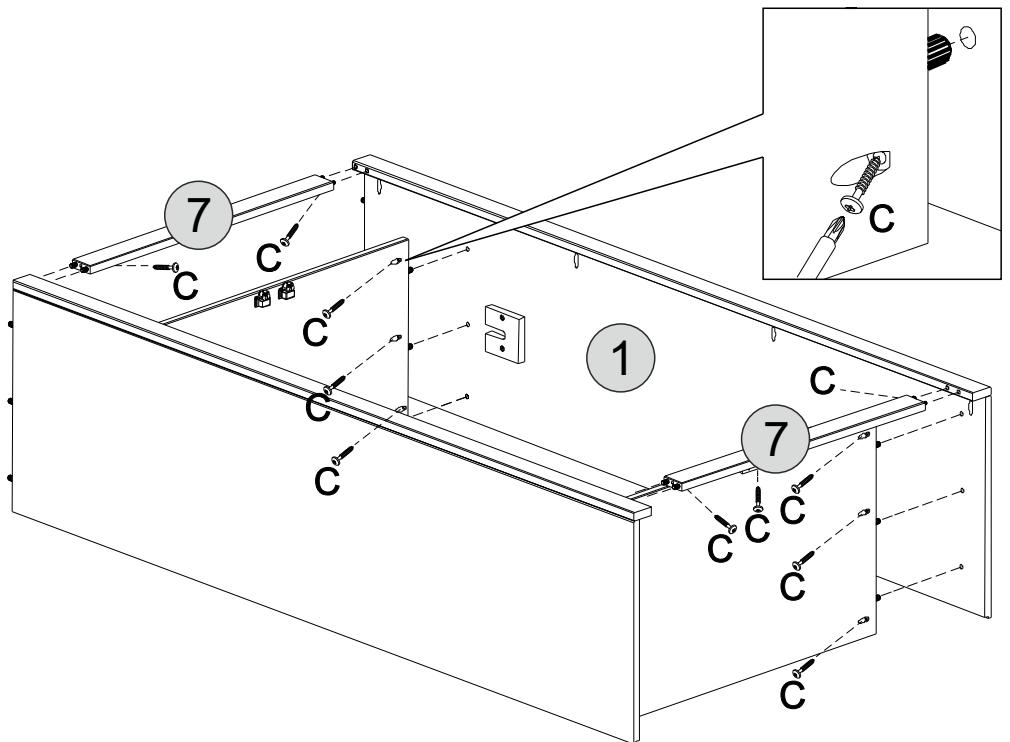
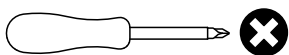

Please assemble on a clean soft surface to avoid damage.

STEP 7

PARTS REQUIRED

5 - TOP PANEL x1

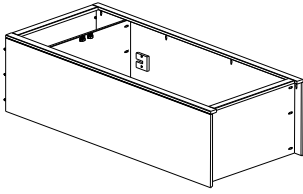

HARDWARE REQUIRED

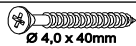
B  06
Ø 4,0 x 40mm

TOOLS REQUIRED

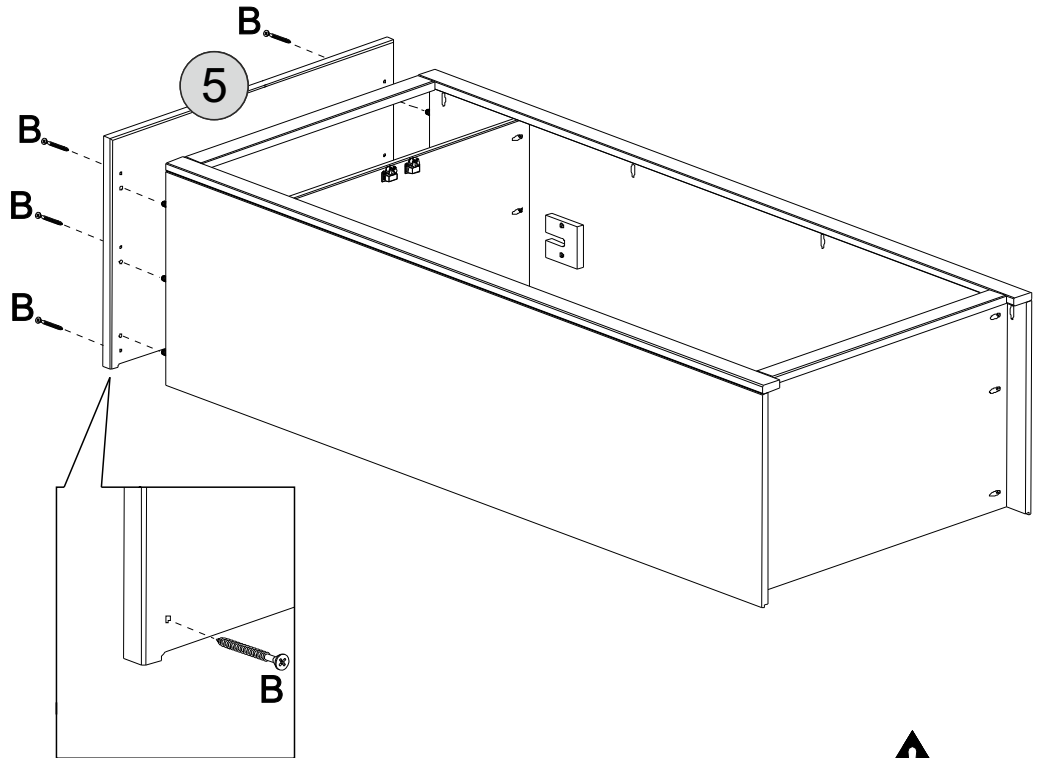
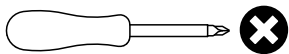

!
Please assemble on a clean soft surface to avoid damage.

STEP 8

PARTS REQUIRED

9 - BACK PANEL x2

10 - BACK PANEL STRIP(UPPER)x1

11 - BACK PANEL STRIP(LOWER)x1

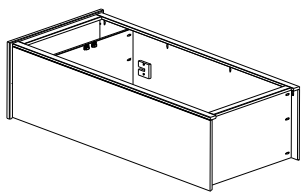

HARDWARE REQUIRED

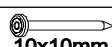
J  46
10x10mm

TOOLS REQUIRED

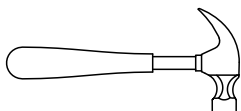

For your future reference order number should be here

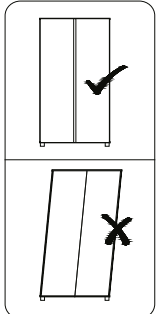
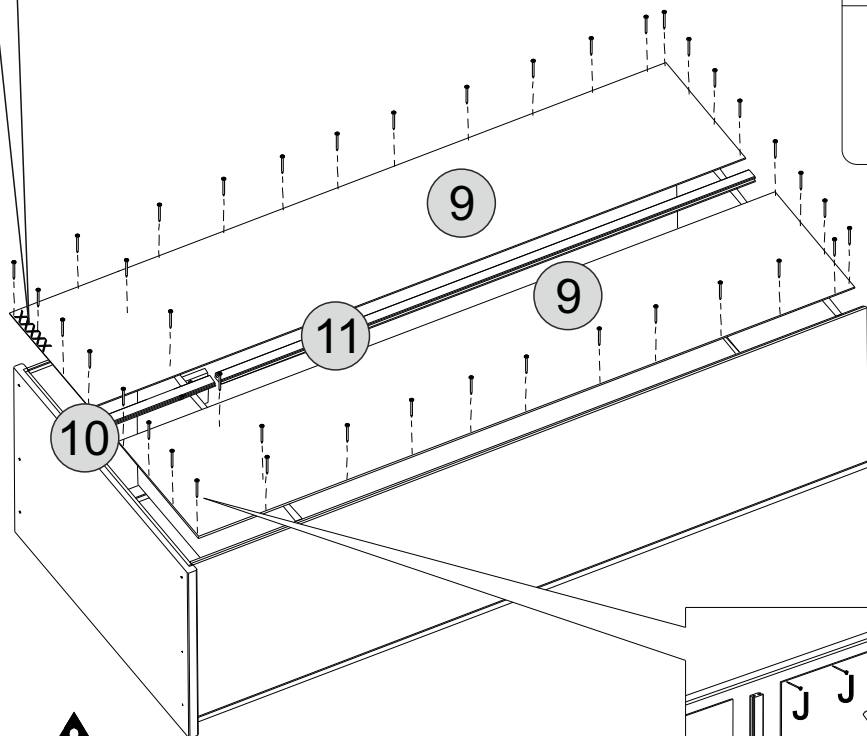

!
Please assemble on a clean soft surface to avoid damage.

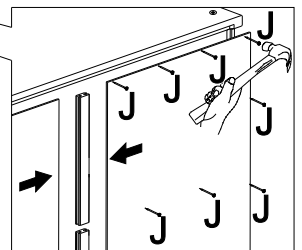





STEP 9

PARTS REQUIRED

13 -RIGHT DOOR	x1
14 -LEFT DOOR	x1
16 -DOOR STRIP	x1

HARDWARE REQUIRED

D	 $\varnothing 3,0 \times 16\text{mm}$	25
E		04
H	 Right	03
I	 Left	03

TOOLS REQUIRED

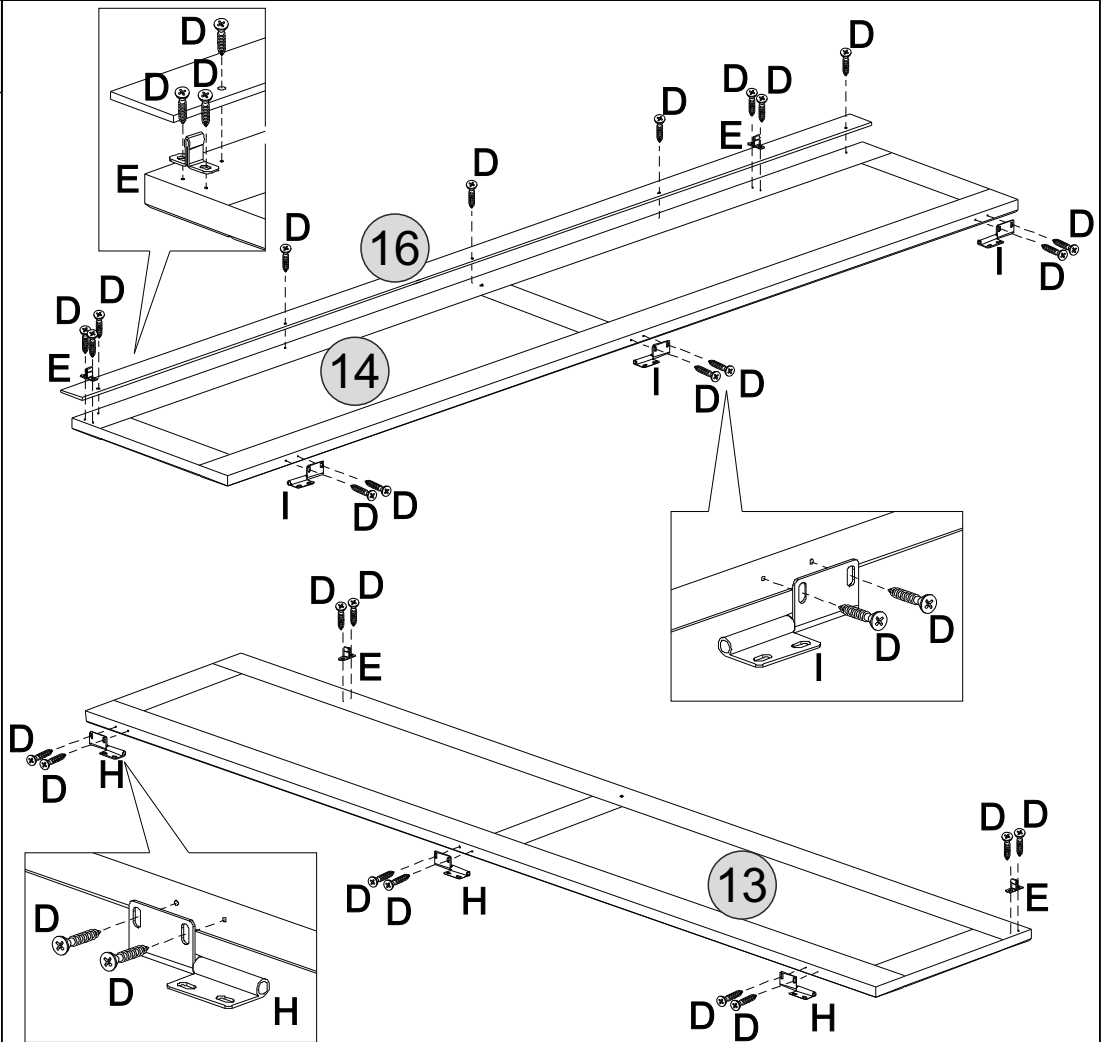
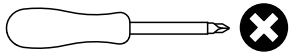



STEP 10

PARTS REQUIRED

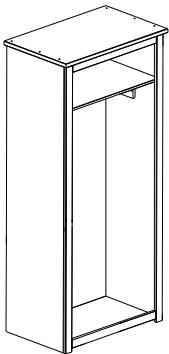
6 - HANGER	x1
13 -RIGHT DOOR	x1
14 -LEFT DOOR	x1



HARDWARE REQUIRED

D	 $\varnothing 3,0 \times 16\text{mm}$	12
F		02
G	 M4 x 25mm	02

TOOLS REQUIRED

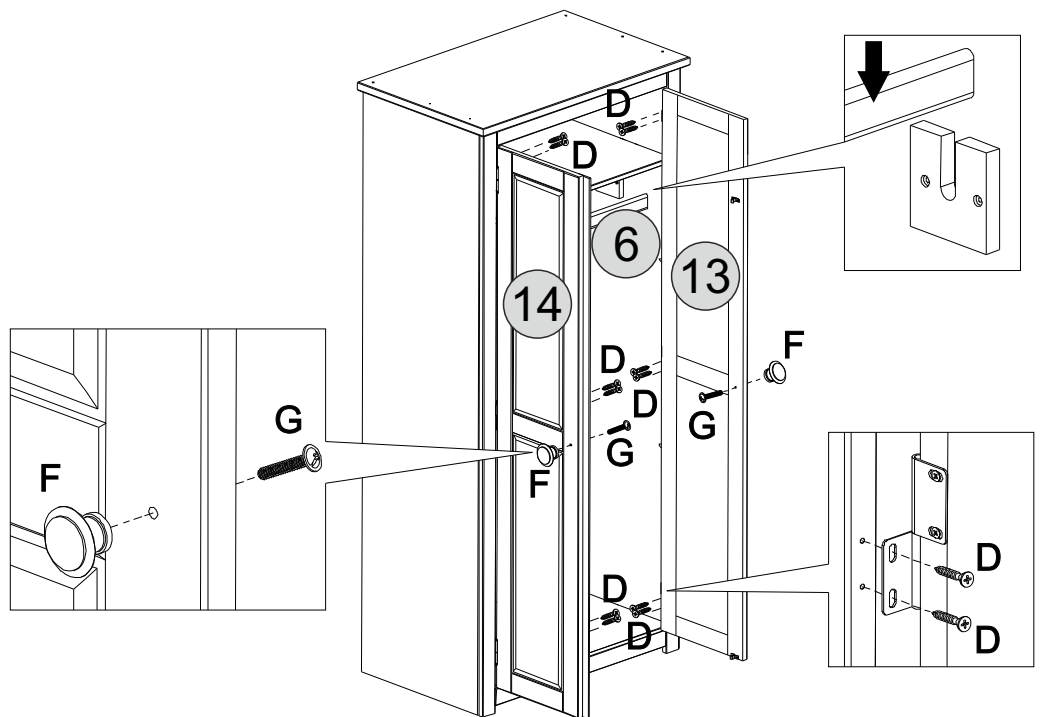
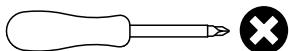

!
Please assemble on a clean soft surface to avoid damage.

STEP 11

PARTS REQUIRED

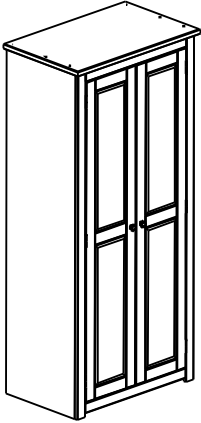

HARDWARE REQUIRED

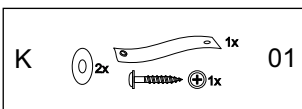

TOOLS REQUIRED

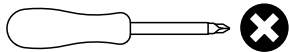

WARNING

Serious or fatal injuries can occur from furniture tipping over. To prevent the furniture from tipping over we recommend that it is permanently fixed to the wall.

Wall fixings are not supplied with this product as different wall materials require different types of fixing devices. Please make sure you use fixings suitable for the walls in your home.

