

# NORDIC 2 DOOR 2 DRAWER WARDROBE ASSEMBLY INSTRUCTIONS



FOR DOMESTIC USE ONLY  
IMPORTANT

PLEASE READ BEFORE YOU CONTINUE FURTHER

THE PRODUCT YOU HAVE PURCHASED WILL GIVE YOU MANY YEARS OF SERVICE IF YOU FOLLOW THE GUIDELINES FOR ITS SAFE ASSEMBLY AND PERIODIC MAINTENANCE AND CLEANING  
ASSEMBLE ON A SOFT CLEAN SURFACE

DO NOT USE ANY TOOLS OTHER THAN THOSE SHOWN

ANY SPANNERS OR ALLEN KEYS REQUIRED ARE INCLUDED WITH THE FITTING KIT.

DO NOT FOR ANY REASON USE A POWER TOOL TO ASSEMBLE THIS PRODUCT. ITS USE WILL INVALIDATE ANY CLAIM YOU MAY HAVE AND COULD MAKE THIS PRODUCT UNSAFE.

DEPENDING ON THE AMOUNT OF USE THIS PRODUCT RECEIVES, IT MAY BE NECESSARY TO TIGHTEN UP THE FIXINGS FROM TIME TO TIME. THIS IS COMPLETELY NORMAL FOR ANY FLAT PACK FURNITURE. DO NOT OVERTIGHTEN FIXINGS.

FOR CLEANING, YOU MAY USE A DAMP CLOTH (NOT WET). DO NOT USE POLISH, DETERGENT OR CHEMICAL CLEANERS.



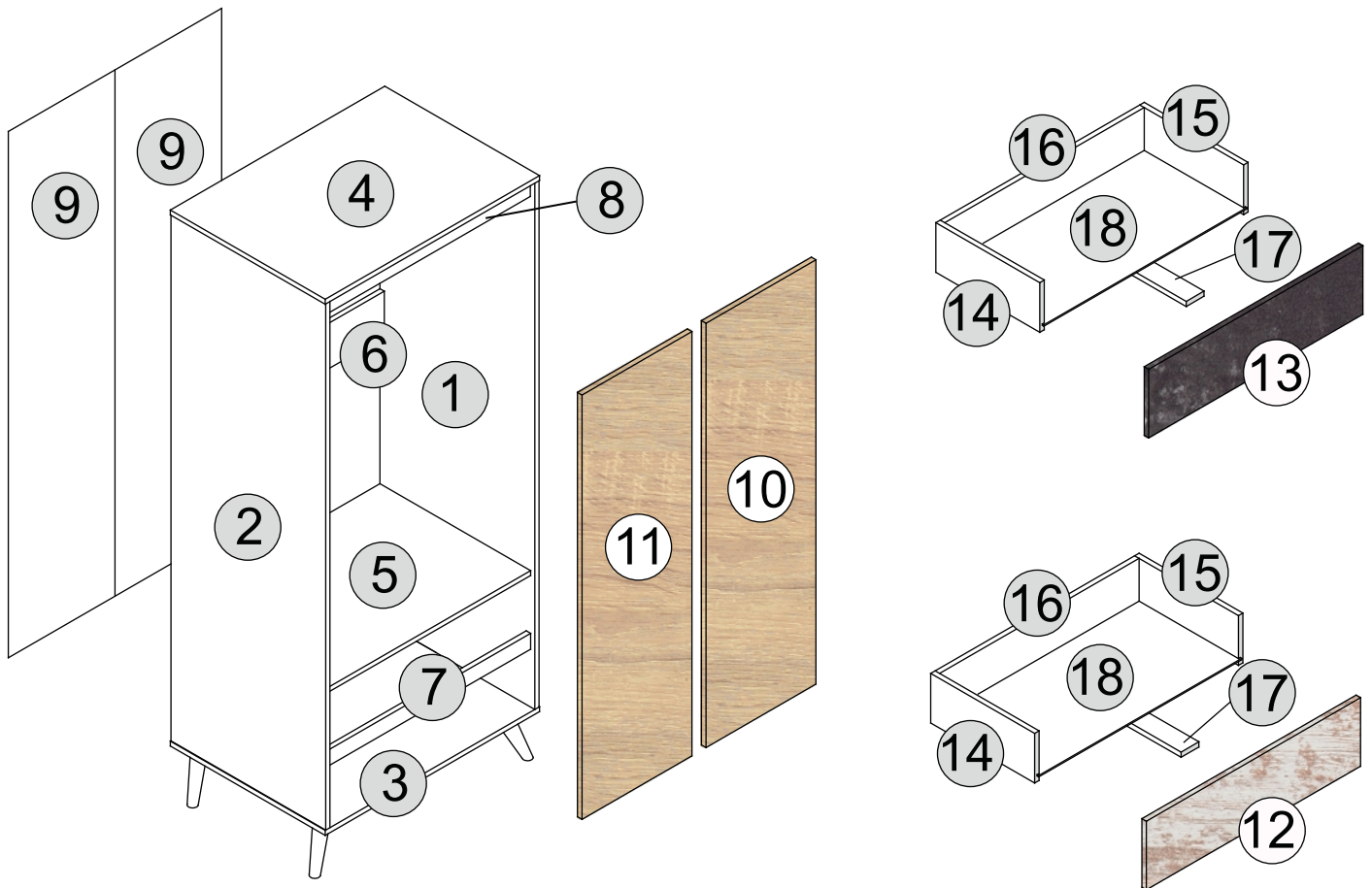





THIS SURFACE OF THIS ITEM IS NOT HEAT RESISTANT. ALWAYS USE A PLACE MAT UNDER HOT OR COLD ITEMS TO PREVENT MARKING.











## PART LIST

Part Number	Part Code	Part Description	Quantity	Carton
1	S100-101-081-ZF1-01	Right Side Panel	1	1/2
2	S100-101-081-ZF1-02	Left Side Panel	1	1/2
3	S100-101-081-ZF1-03	Bottom Panel	1	2/2
4	S100-101-081-ZF1-04	Top Panel	1	2/2
5	S100-101-081-ZF1-05	Shelf Panel	1	2/2
6	S100-101-081-ZF1-06	Back Support	1	2/2
7	S100-101-081-ZF1-07	Bottom Support Panel	1	2/2
8	S100-101-081-ZF1-08	Top Support Panel	1	2/2
9	S100-101-081-ZF1-09	Back Panel	2	1/2
10	S100-101-081-ZF1-10	Right Door	1	1/2
11	S100-101-081-ZF1-11	Left Door	1	1/2
12	S100-101-081-ZF1-12	Top Drawer Front	1	2/2
13	S100-101-081-ZF1-13	Bottom Drawer Front	1	2/2
14	S100-101-081-ZF1-14	Left Drawer Side	2	2/2
15	S100-101-081-ZF1-15	Right Drawer Side	2	1/2
16	S100-101-081-ZF1-16	Drawer Back	2	2/2
17	S100-101-081-ZF1-17	Drawer Support	2	2/2
18	S100-101-081-ZF1-18	Drawer Base	2	2/2

# HARDWARE LIST

No.	Part Name		Qty	Carton
A	Wooden Dowel (6x25mm)		x28	1
B	45mm Screw (4x45mm)		x16	1
C	14mm Screw (3.5x14mm)		x58	1
D	38mm Screw (4x38mm)		x10	1
E	Minifix Cam Bolt (8032T)		x6	1
F	Minifix Cam Nut (1512)		x6	1
G	Wooden Leg+Plastic Foot		x4	2
H	6/8" Nail		x65	1
I	14" Drawer Slide (0.9mm W (vkt))		x2 set	1

No.	Part Name		Qty	Carton
J	PVC L- Bracket		x1	1
K	Handle + Screw Y-8238 (3x16mm=2pcs)		x1	1
L	Screw Cover (CB-White)		x8	1
M	5" Hinge		x4	1
N	Hanging Rail (722mm)		x1	1
O	Hanging Rail Support		x2	1
P	Handle+Screw T-4538 (4x20mm=2pcs)		x2	1
Q	Handle + Screw L-3510 (3x16mm=4pcs)		x1	1
R	Wall Fixings (4x20mm=1pc)		x1	1

## TIPS FOR FITTINGS CAM-LOCKS

WHEN FITTING CAM NUT. ENSURE STARTING POSITION IS CORRECT BEFORE YOU INSERT CONNECTING CAM BOLT TURN CLOCKWISE UNTIL SECURE

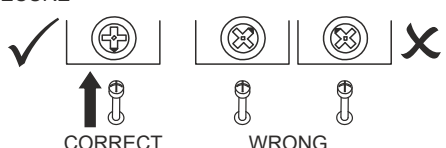

CORRECT
WRONG

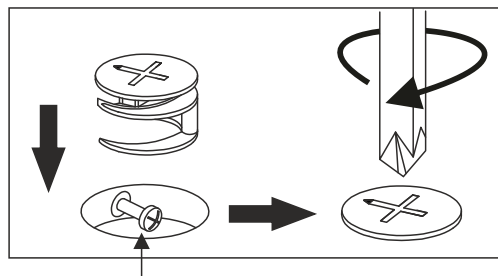

Cam bolt head needs to be in centre

### CAMBOLT

**Tighten until shoulder in flush with panel. Do not overtighten or undertighten (see example below)**

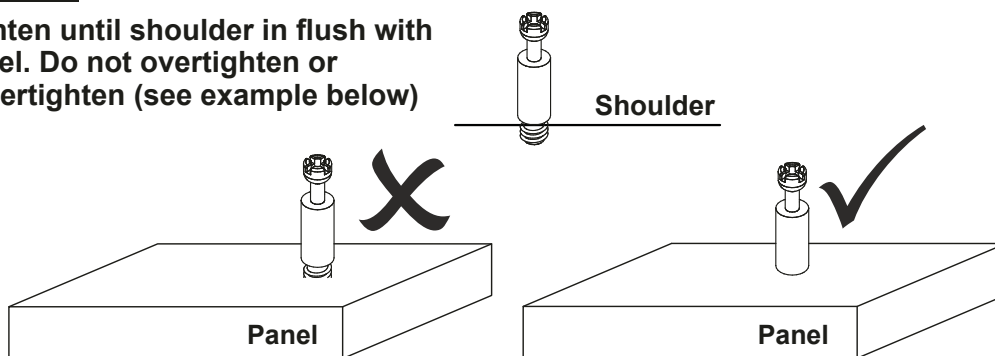



# STEP 1

## PARTS REQUIRED

2 - LEFT SIDE PANEL x1

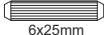
## HARDWARE REQUIRED

A  04  
6x25mm

C  10  
3.5x14mm

I  02

M  02

O  01

## TOOLS REQUIRED

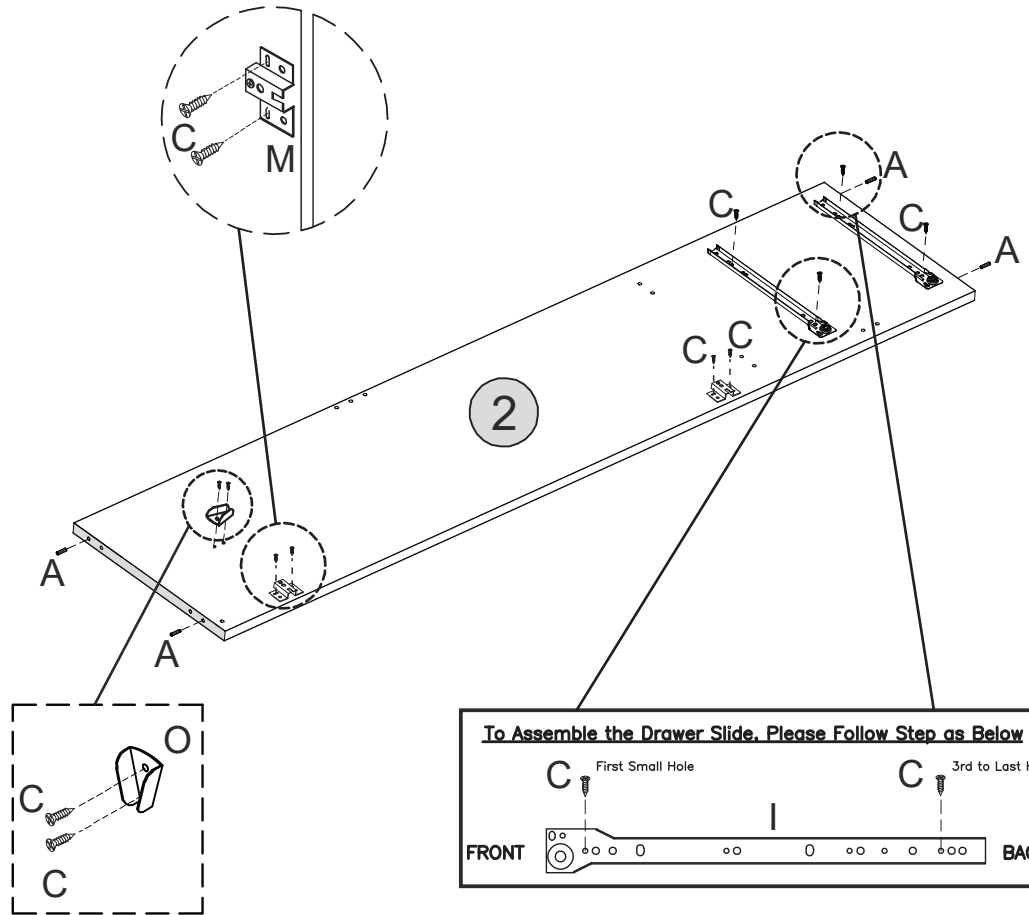
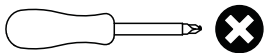



# STEP 2

## PARTS REQUIRED

1 - RIGHT SIDE PANEL x1

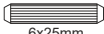
## HARDWARE REQUIRED

A  04  
6x25mm

C  10  
3.5x14mm

I  02

M  02

O  01

## TOOLS REQUIRED

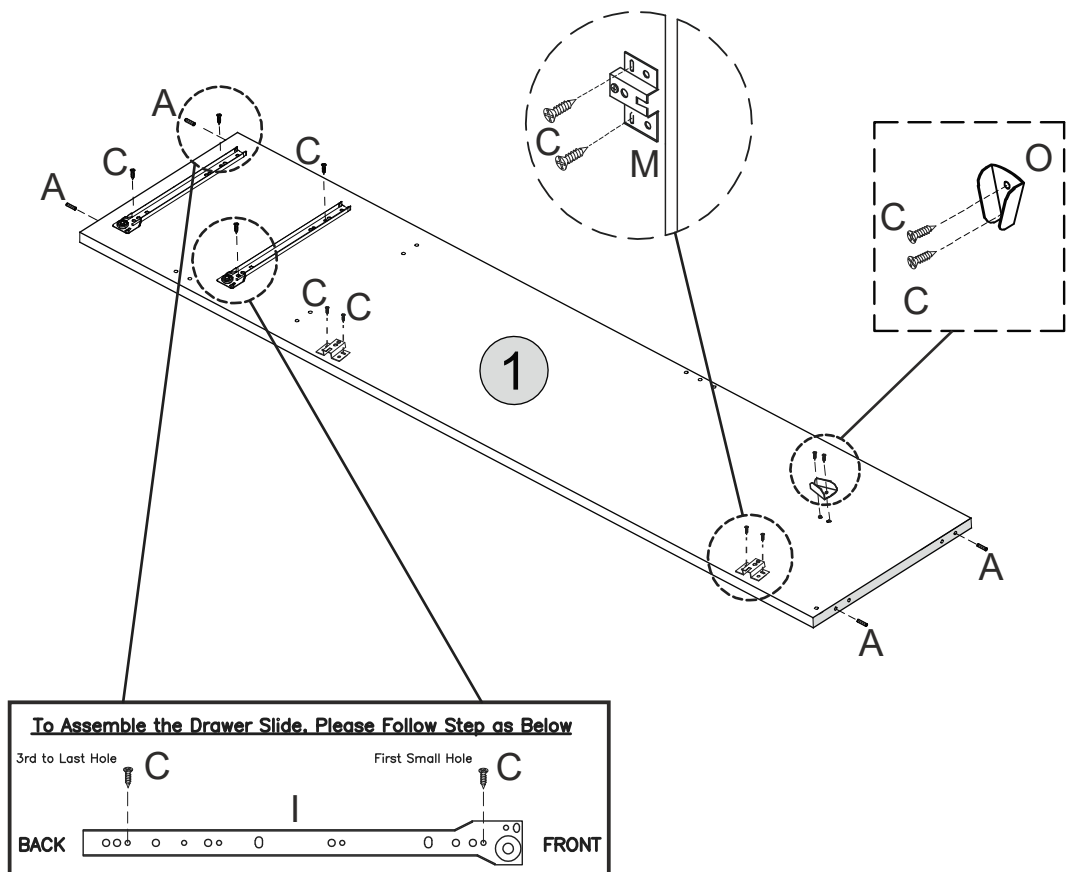
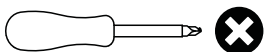

# STEP 3

## PARTS REQUIRED

5 - SHELF PANEL x1

6 - BACK SUPPORT x1

7 - BOTTOM SUPPORT PANEL x1

8 - TOP SUPPORT PANEL x1

## HARDWARE REQUIRED

A  12

## TOOLS REQUIRED

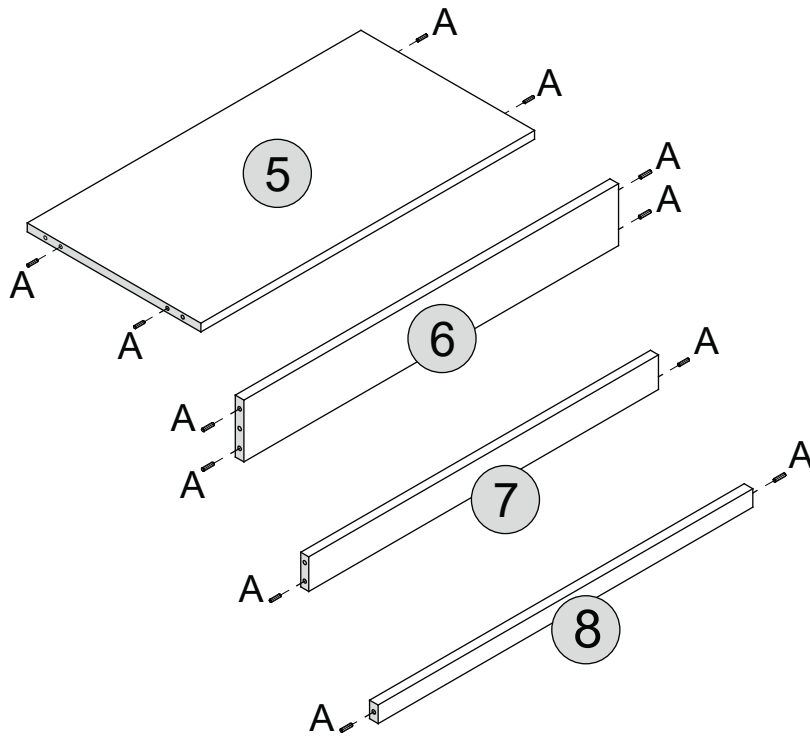

# STEP 4

## PARTS REQUIRED

2 - LEFT SIDE PANEL x1

5 - SHELF PANEL x1

6 - BACK SUPPORT x1

7 - BOTTOM SUPPORT PANEL x1

## HARDWARE REQUIRED

B  04

## TOOLS REQUIRED

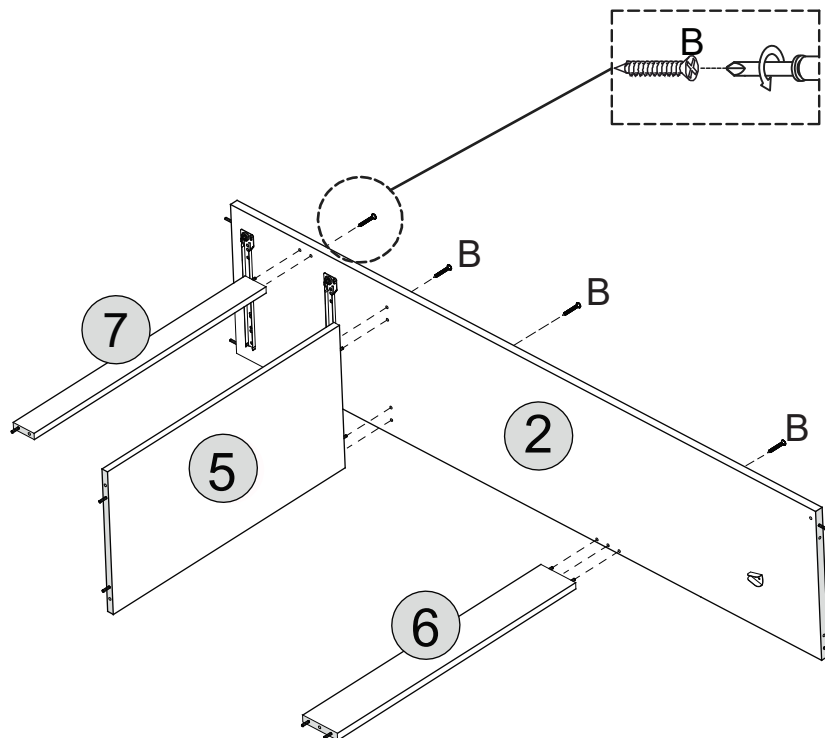
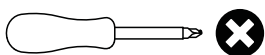

# STEP 5

## PARTS REQUIRED

1 - RIGHT SIDE PANEL x1

8 - TOP SUPPORT PANEL x1

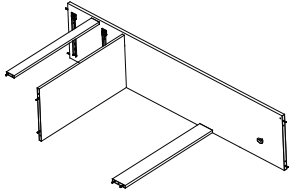

## HARDWARE REQUIRED

B  04  
4x45mm

## TOOLS REQUIRED

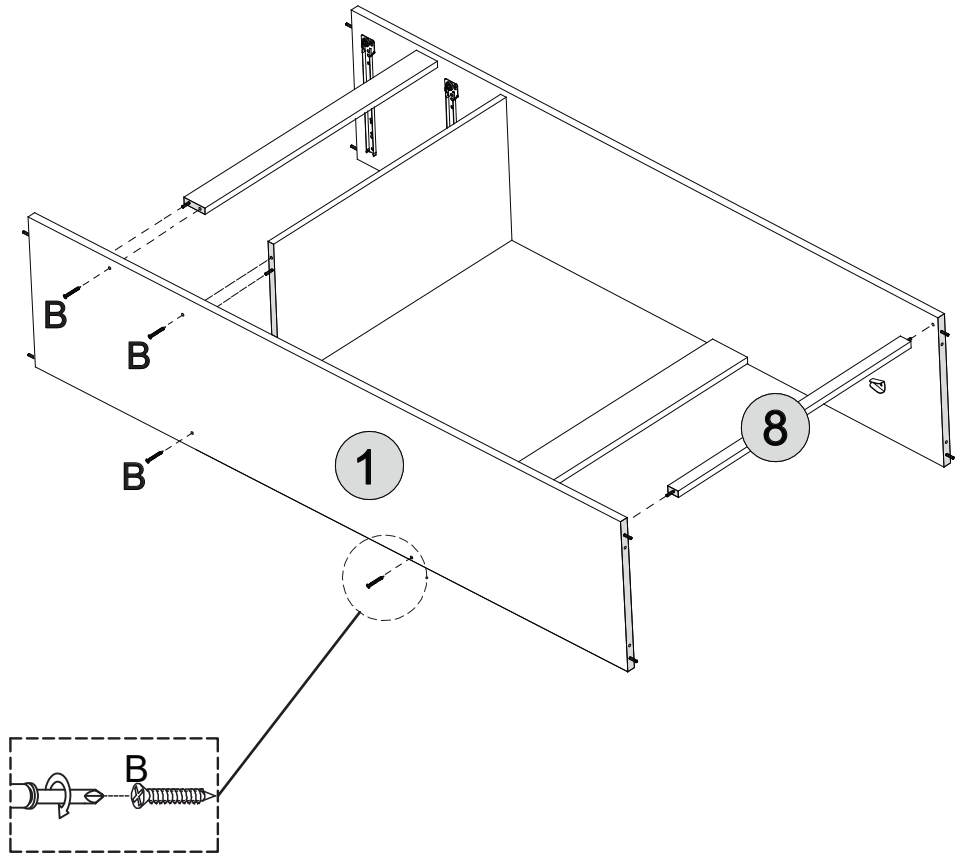
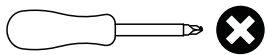

# STEP 6

## PARTS REQUIRED

4 - TOP PANEL x1

## HARDWARE REQUIRED

C  02  
3.5x14mm

J  01

## TOOLS REQUIRED

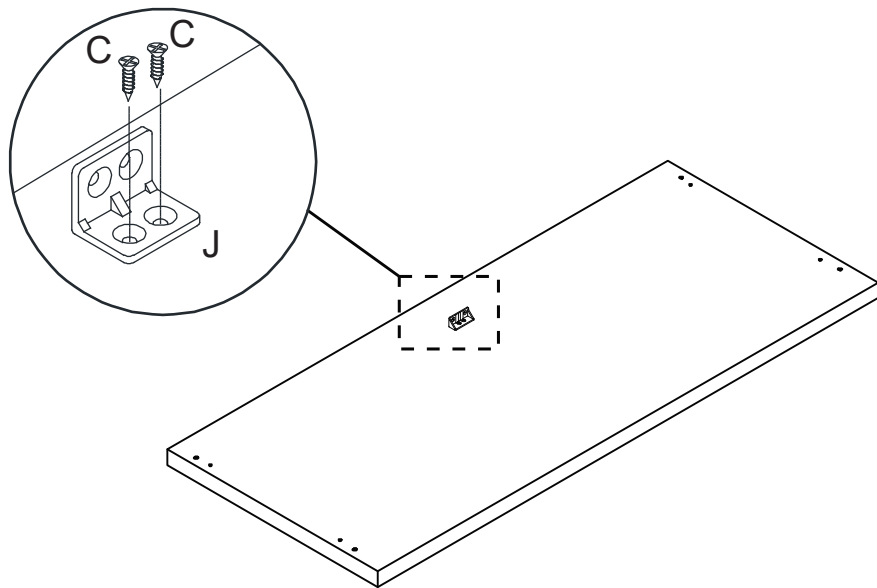
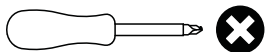

# STEP 7

## PARTS REQUIRED

3 - BOTTOM PANEL x1

4 - TOP PANEL x1

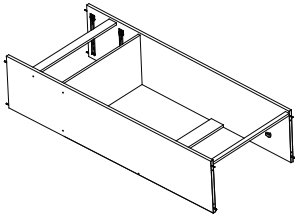

## HARDWARE REQUIRED

B  08

C  02

## TOOLS REQUIRED

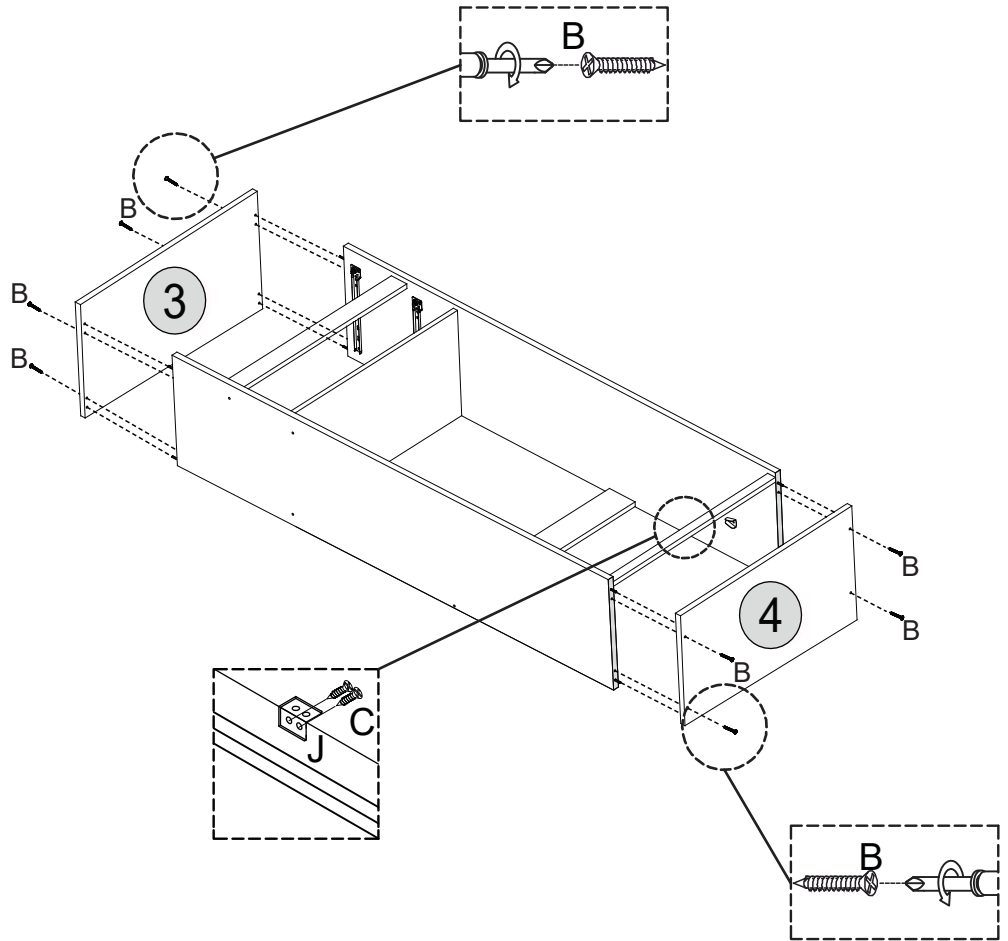
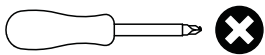

# STEP 8

## PARTS REQUIRED

9 - BACK PANEL x2

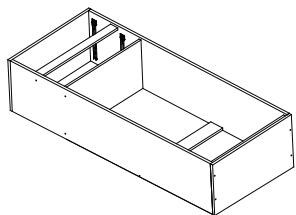

## HARDWARE REQUIRED

C  18

G  04

H  65

## TOOLS REQUIRED

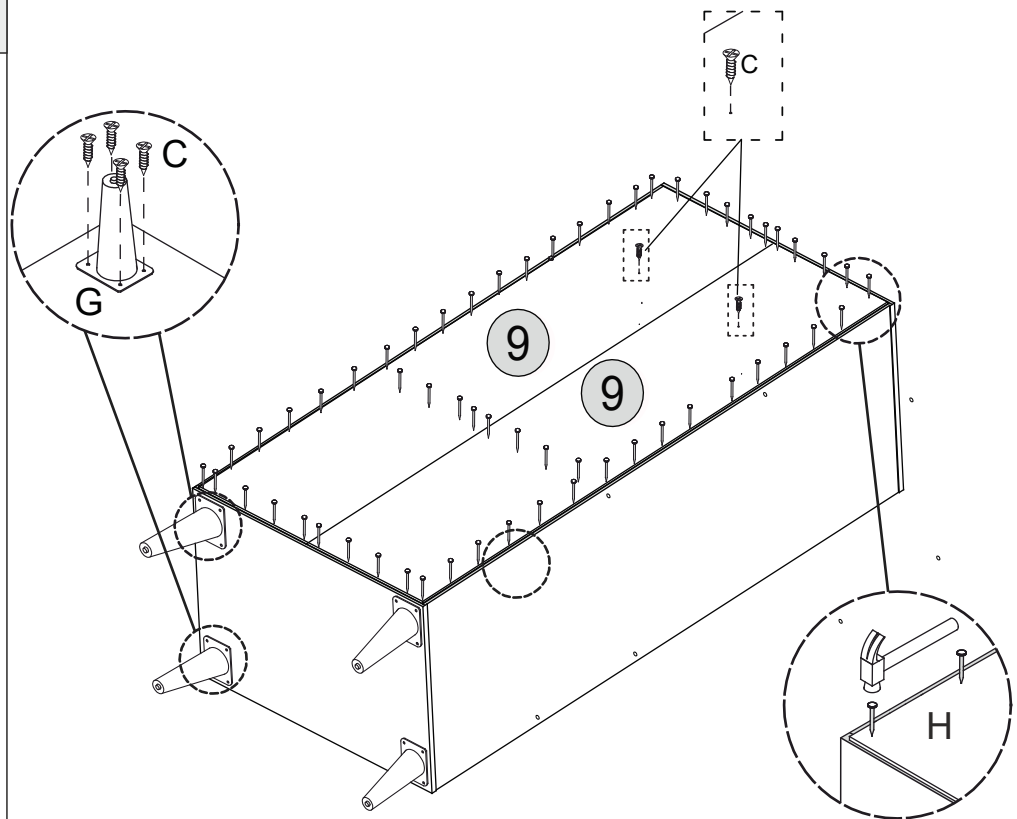
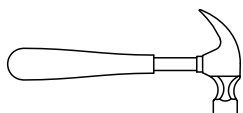
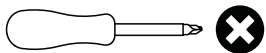



# STEP 9

## PARTS REQUIRED

12 - TOP DRAWER FRONT	x1
14 -LEFT DRAWER SIDE	x1
15 -RIGHT DRAWER SIDE	x1
17 -DRAWER SUPPORT	x1

## HARDWARE REQUIRED

A		04
E		03
F		03

## TOOLS REQUIRED

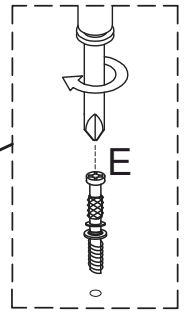
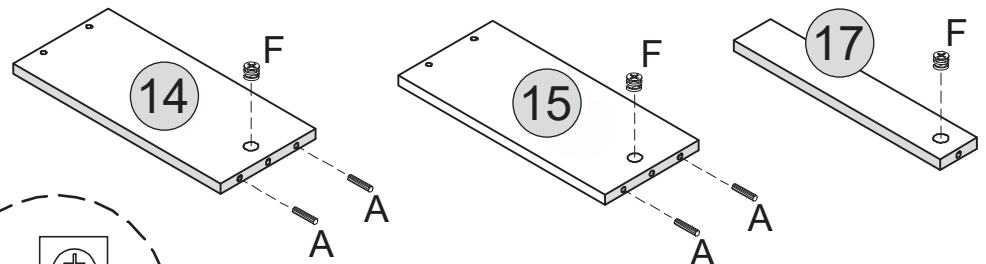
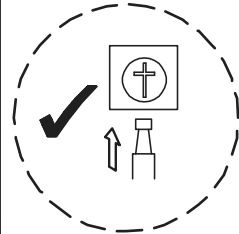
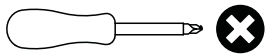

# STEP 10

## PARTS REQUIRED

12 -TOP DRAWER FRONT	x1
14 -LEFT DRAWER SIDE	x1
15 -RIGHT DRAWER SIDE	x1
16 -DRAWER BACK	x1
17 -DRAWER SUPPORT	x1
18 -DRAWER BASE	x1

## HARDWARE REQUIRED

D		05
---	---	----

## TOOLS REQUIRED

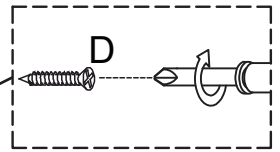
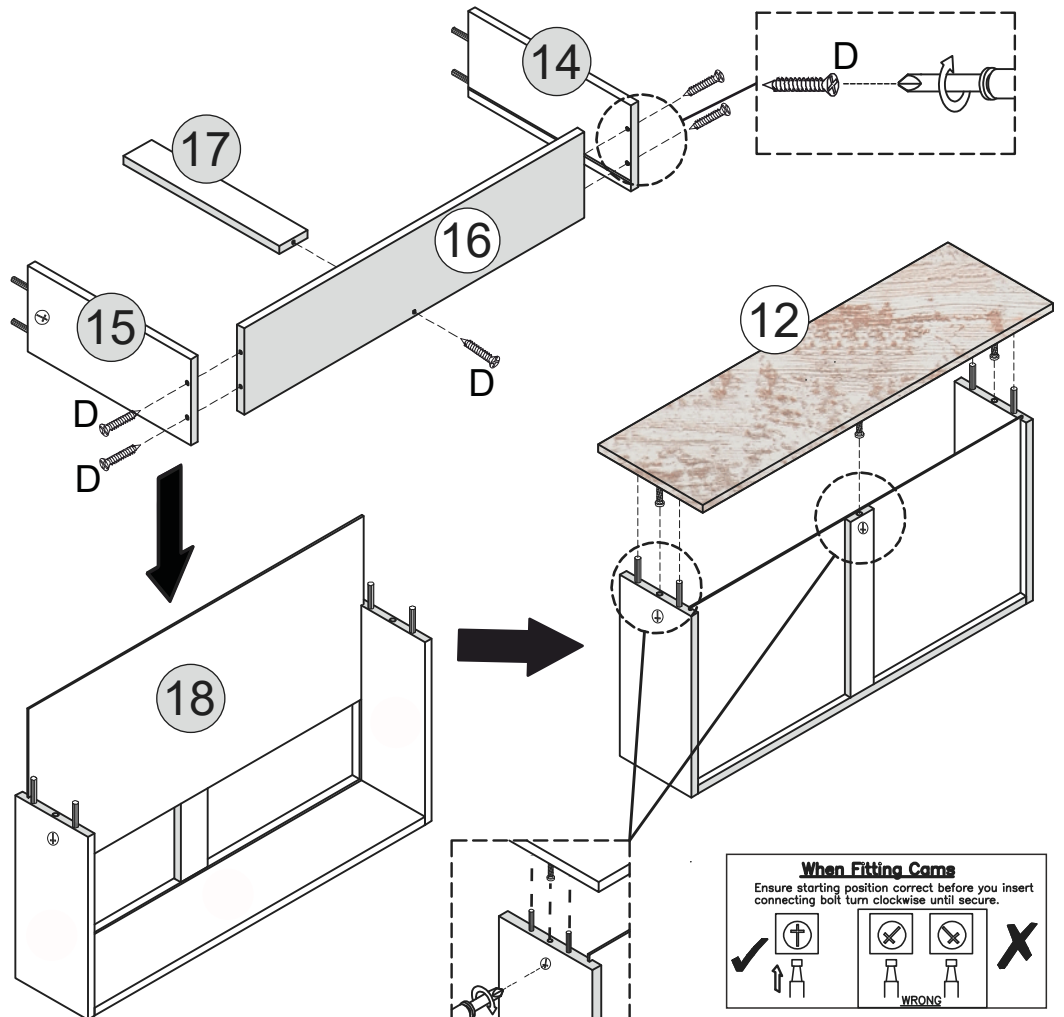
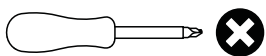

**When Fitting Cam**  
Ensure starting position correct before you insert connecting bolt turn clockwise until secure.



# STEP 11

## PARTS REQUIRED

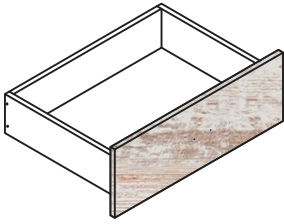

## HARDWARE REQUIRED

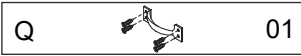
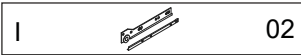
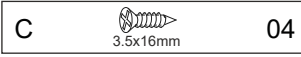

## TOOLS REQUIRED

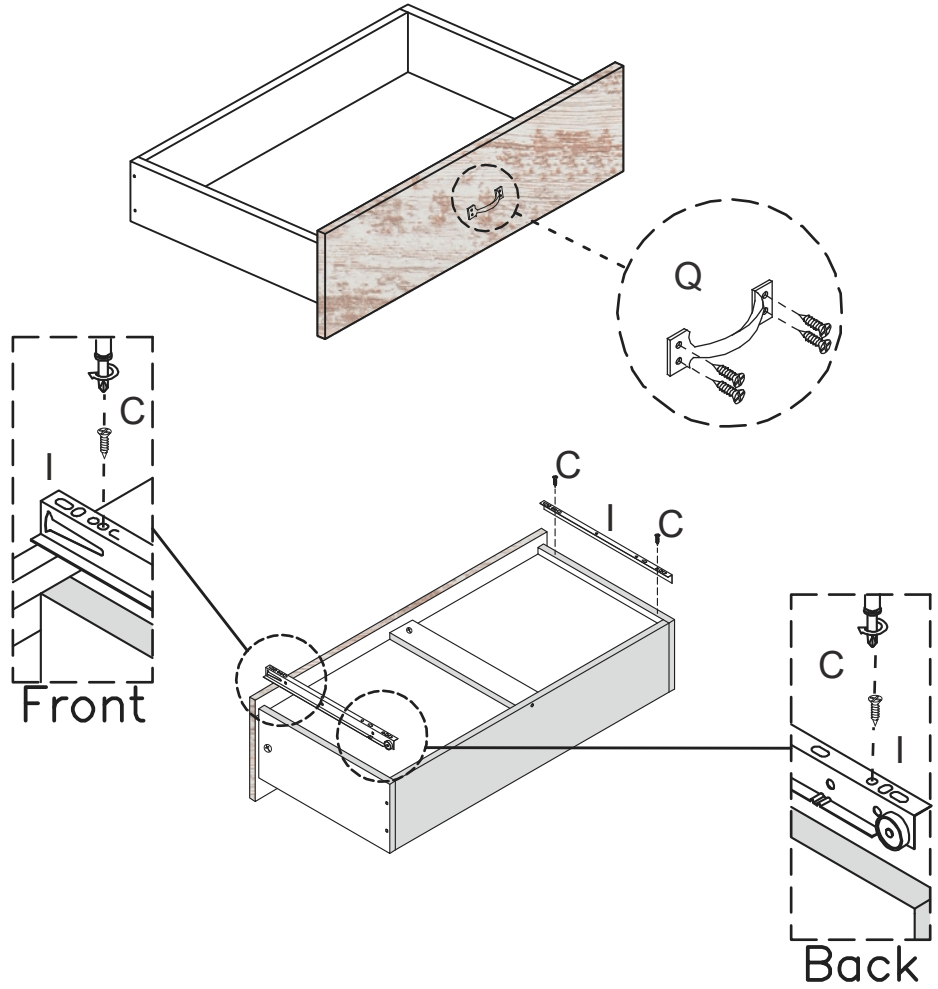
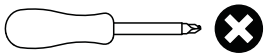

# STEP 12

## PARTS REQUIRED

13 -BOTTOM DRAWER FRONT x1

14 -LEFT DRAWER SIDE x1

15 -RIGHT DRAWER SIDE x1

17 -DRAWER SUPPORT x1

## HARDWARE REQUIRED

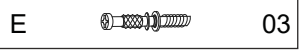
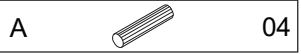

## TOOLS REQUIRED

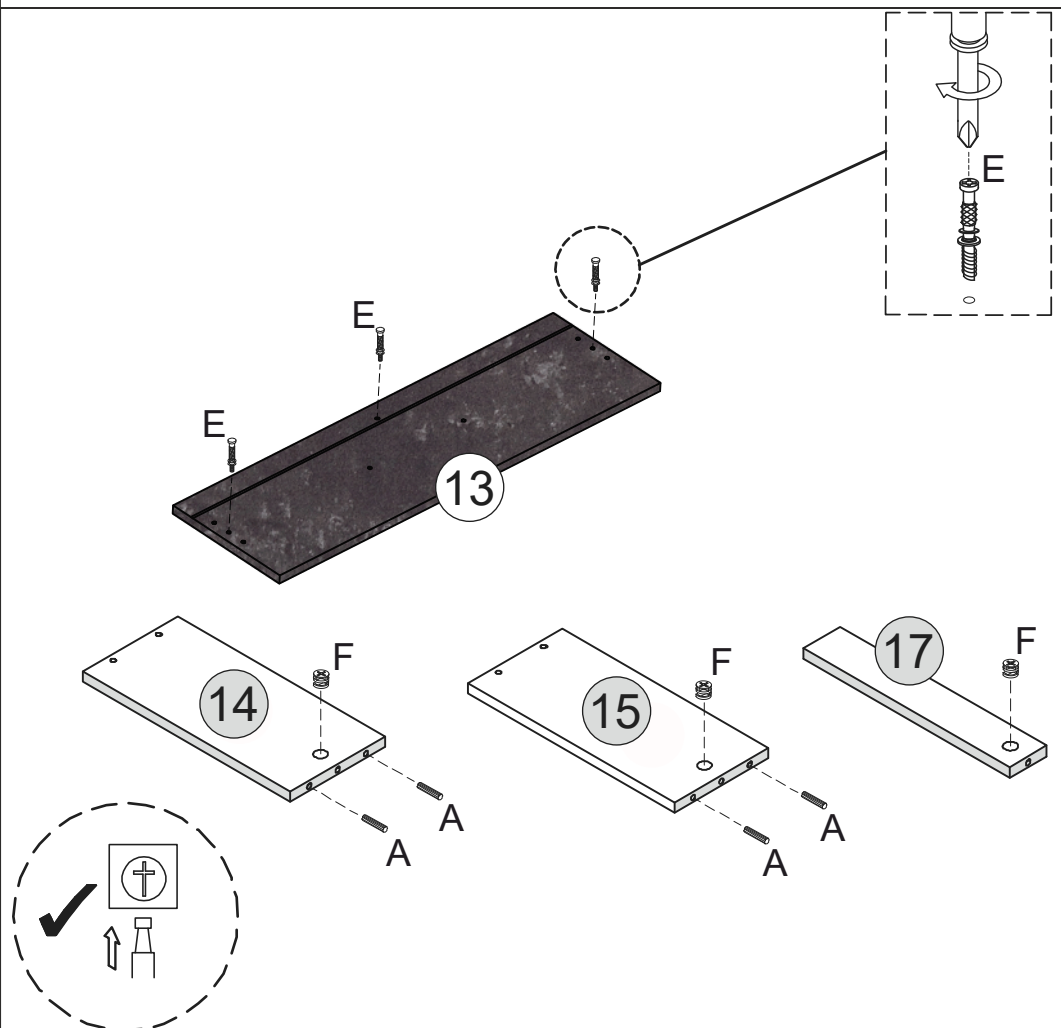
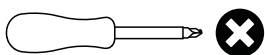

# STEP 13

## PARTS REQUIRED

- 13 - BOTTOM DRAWER FRONT x1
- 14 - LEFT DRAWER SIDE x1
- 15 - RIGHT DRAWER SIDE x1
- 16 - DRAWER BACK x1
- 17 - DRAWER SUPPORT x1
- 18 - DRAWER BASE x1

## HARDWARE REQUIRED

- D  05

## TOOLS REQUIRED

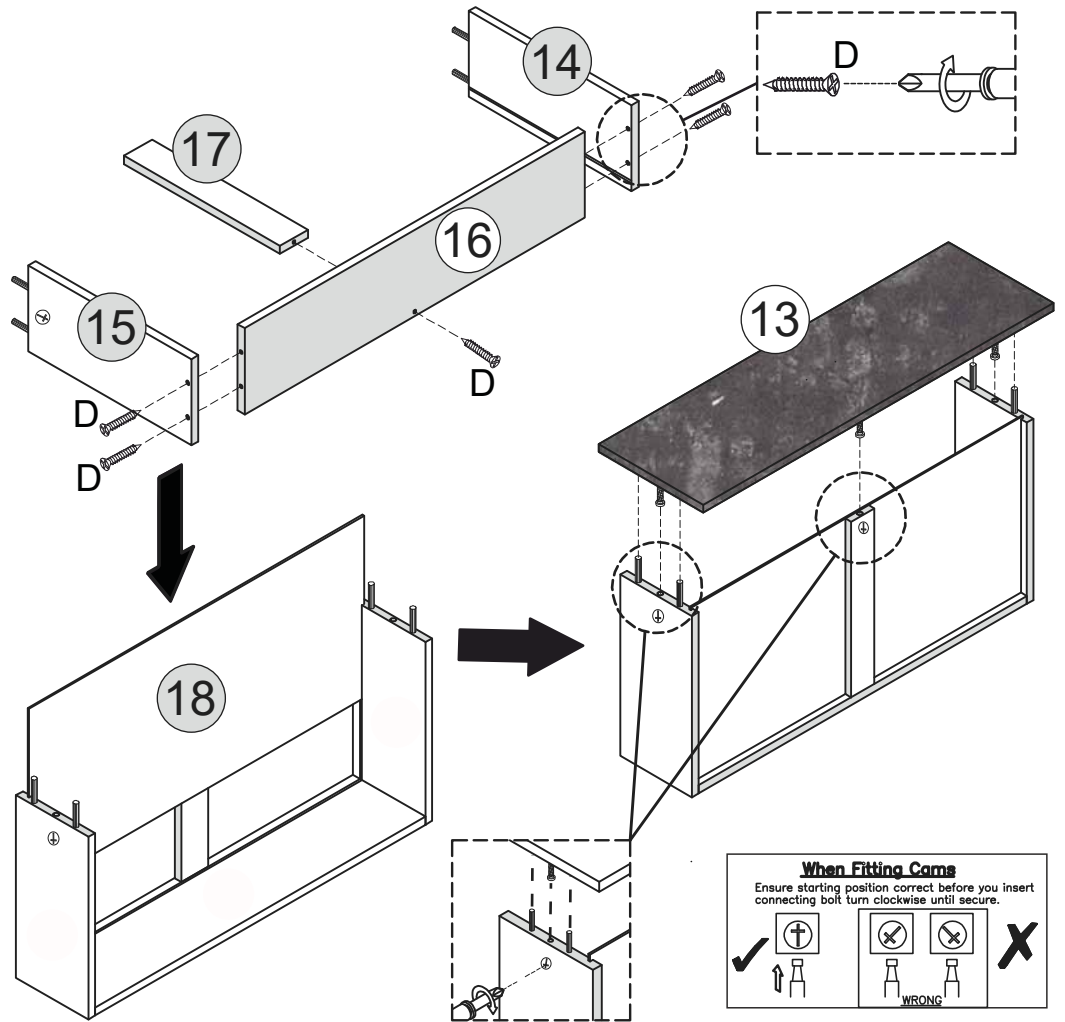
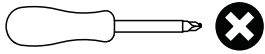

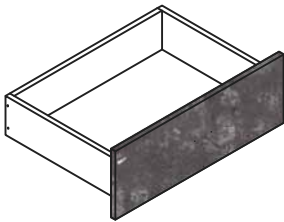

# STEP 14

## PARTS REQUIRED



## HARDWARE REQUIRED

- C  04
- I  02
- K  01

## TOOLS REQUIRED

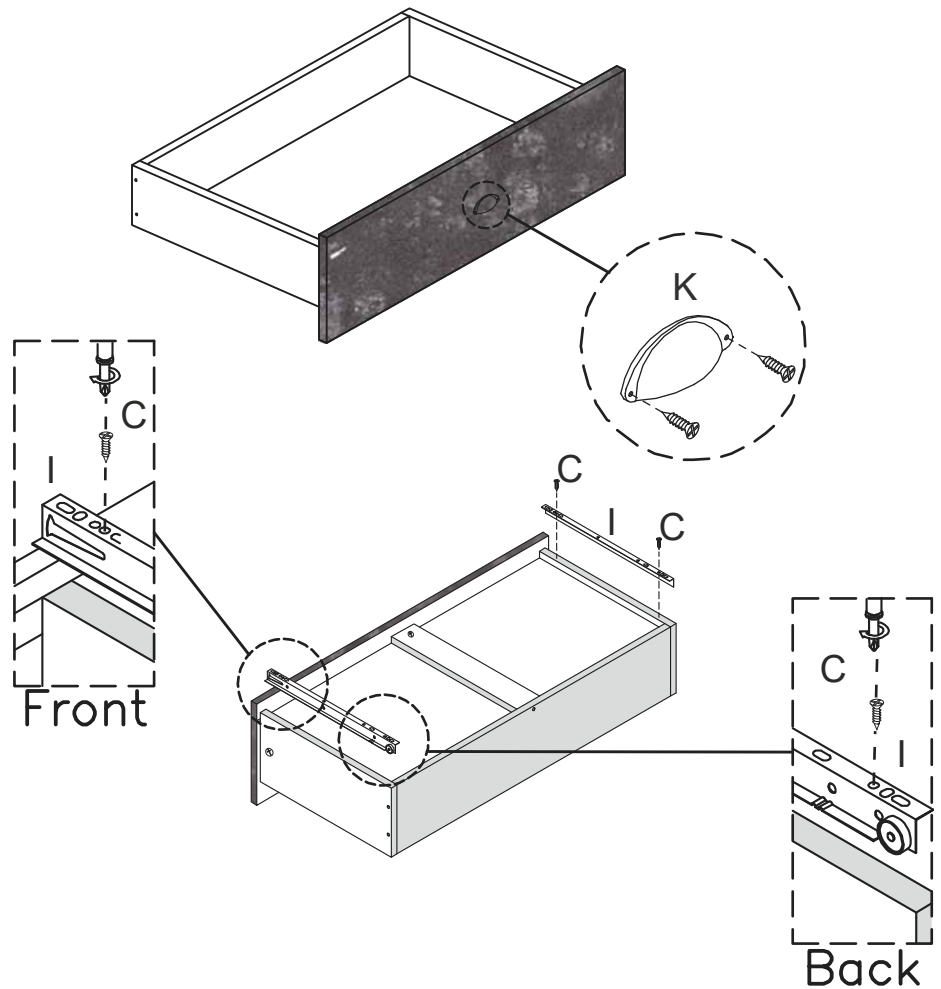
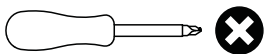

# STEP 15

## PARTS REQUIRED

10 - RIGHT DOOR x1

11 - LEFT DOOR x1

## HARDWARE REQUIRED

C  08

M  04

## TOOLS REQUIRED

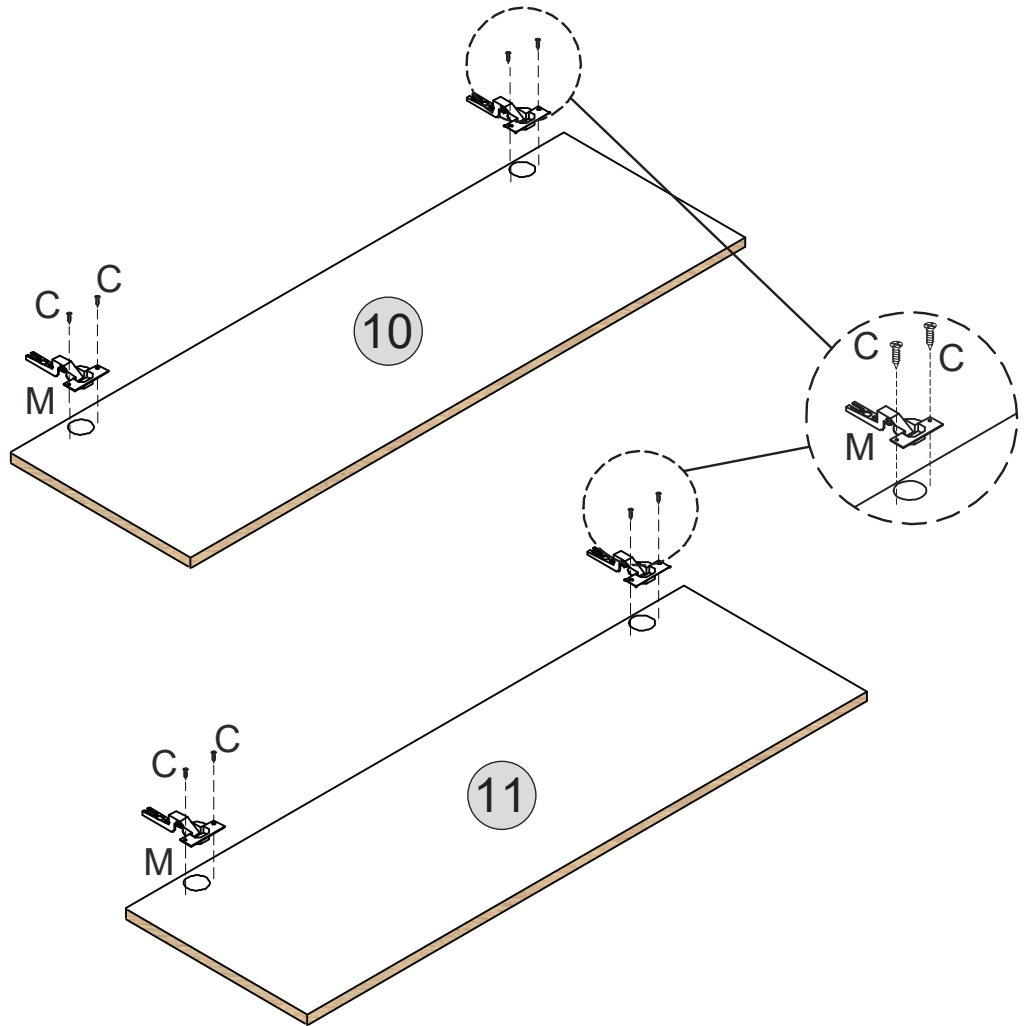
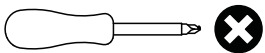

# STEP 16

## PARTS REQUIRED

10 - RIGHT DOOR x1

11 - LEFT DOOR x1

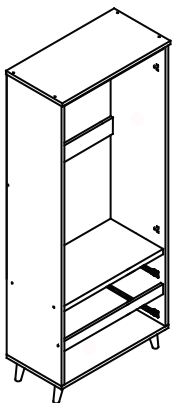

## HARDWARE REQUIRED

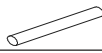
N  01

P  02

## TOOLS REQUIRED

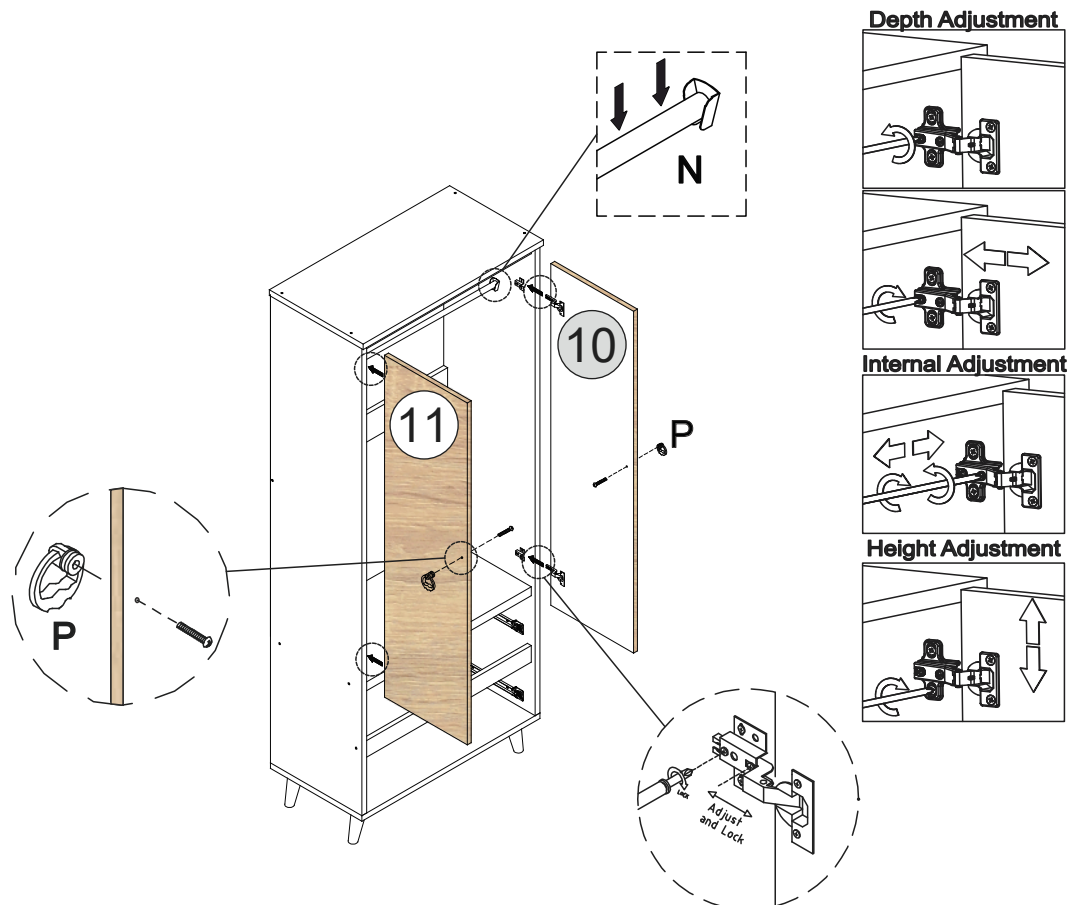
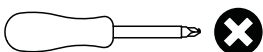

# STEP 17

**PARTS REQUIRED**



**HARDWARE REQUIRED**

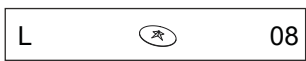

**TOOLS REQUIRED**

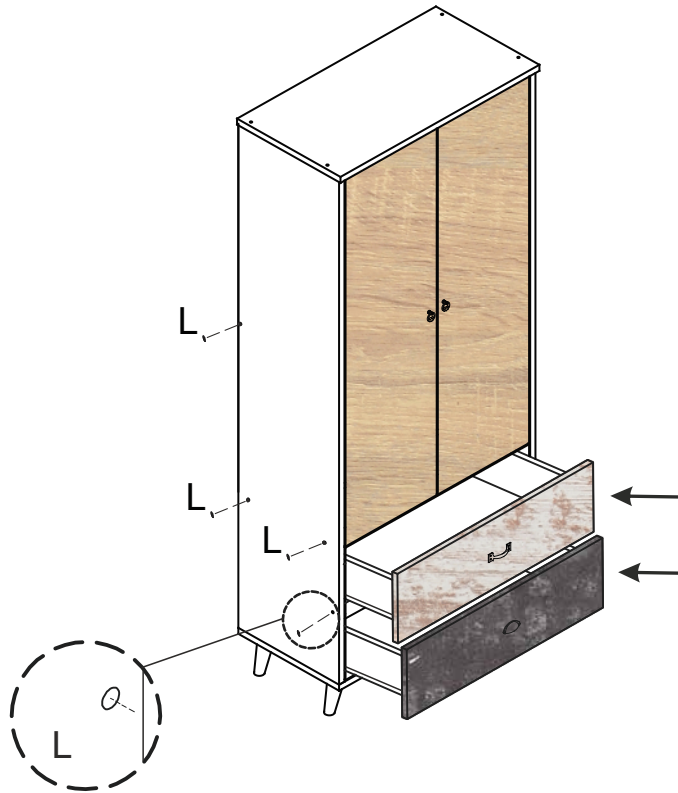

# STEP 18

**PARTS REQUIRED**

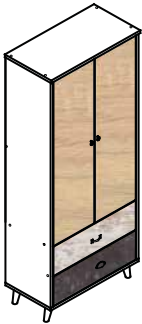

**HARDWARE REQUIRED**



**TOOLS REQUIRED**

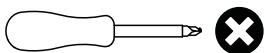

## WARNING

**Serious or fatal injuries can occur from furniture tipping over. To prevent the furniture from tipping over we recommend that it is permanently fixed to the wall.**

Wall fixings are not supplied with this product as different wall materials require different types of fixing devices. Please make sure you use fixings suitable for the walls in your home.

