

NEVADA 2 DOOR CORNER WARDROBE ASSEMBLY INSTRUCTIONS

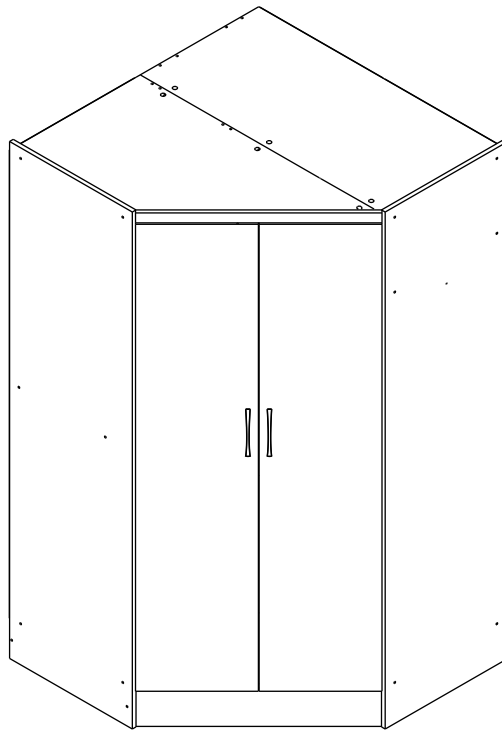

IMPORTANT FOR DOMESTIC USE ONLY

PLEASE READ BEFORE YOU CONTINUE FURTHER

CARE AND MAINTENANCE

After unpacking this product please keep the original packaging in case it needs to be returned for any reason.

- Please ensure all fittings and parts are present before commencing with assembly.
- Never drag or push products as this could cause damage to the joints making it inferior.
- We strongly recommend that you keep children away from your work area.
- We recommend that you lay a blanket or sheet on the floor to avoid damage to both your floor and the product.
- Assemble this product as close to its final position as possible.
- Do not place this product next to a radiator or in direct sunlight.
- Do not drag or push items across your high gloss furniture as this may cause the surface to scratch
- Wood is a natural product and may expand if subjected to damp and may shrink or crack if subjected to heat. Therefore it is recommended that room temperature is maintained, with no sudden temperature fluctuations.
- Make sure any spillage is wiped off immediately.
- Do not place hot or chilled items directly on to the surface, use a place mat or marking will occur.
- For general cleaning use a soft cotton or micro fibre cloth, and do not use detergents of any kind.
- From time to time it may be necessary to tighten fittings, regular inspections should be carried out.
- Do not place on a wet or damp floor as staining may occur to your floor.

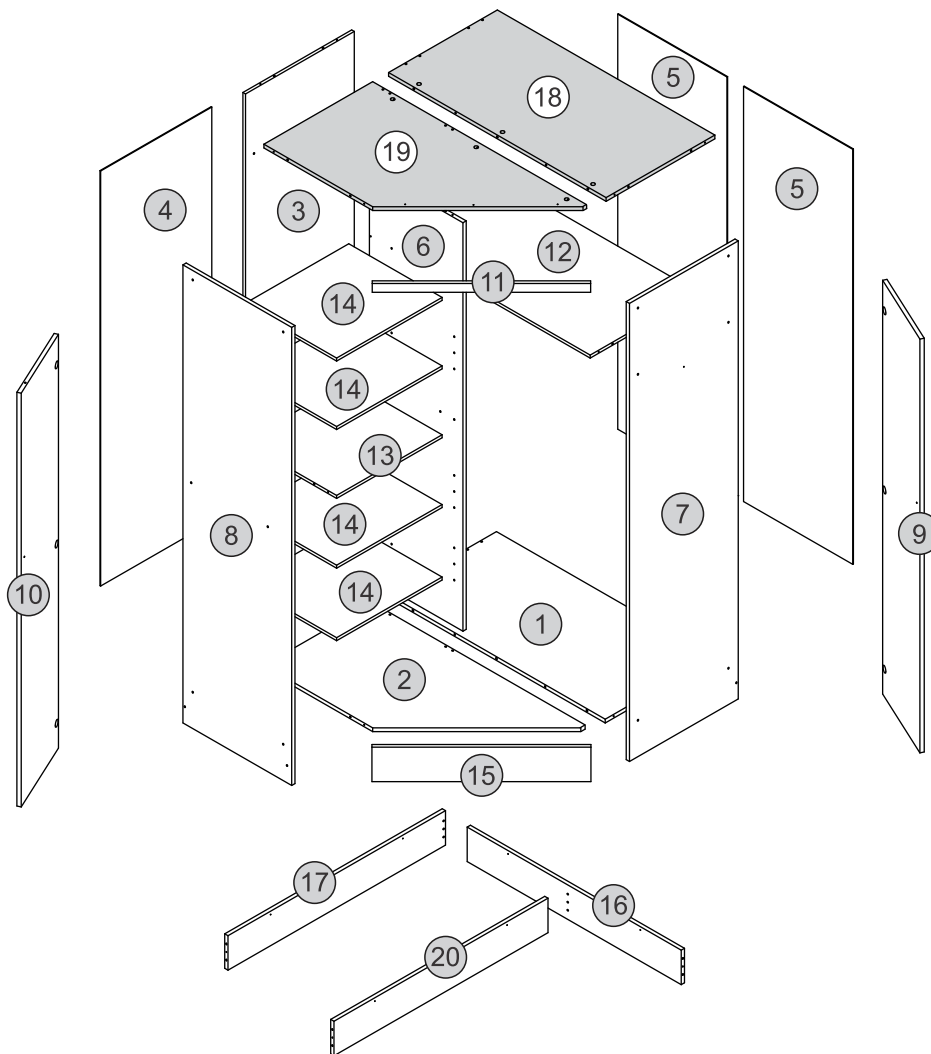

After assembly use an alcohol based product/cleaner to erase the numbers printed on the parts that are visual.

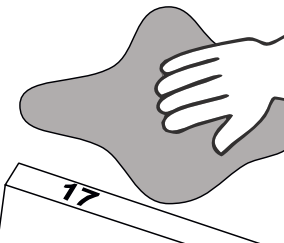

PARTS LIST







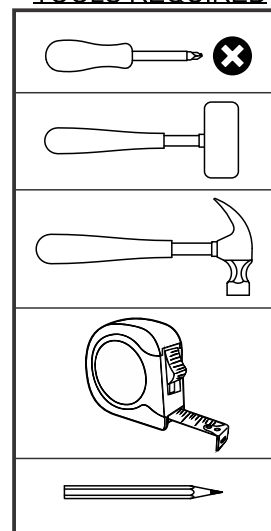

Please Note:
The below parts have all been stamped with the part number to help identify them during assembly.

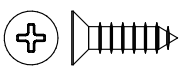
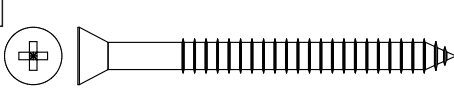
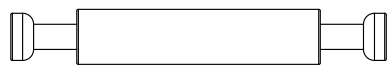
Part Number	Part Description	Quantity	Carton
1	Base Panel	1	3/3
2	Angled Base Panel	1	3/3
3	BackBoard	1	1/3
4	Large Back Panel	1	1/3
5	Small Back Panel	2	1/3
6	Division Panel	1	2/3
7	Right Side Panel	1	1/3
8	Left Side Panel	1	1/3
9	Right Door	1	2/3
10	Left Door	1	2/3
11	Upper Frame	1	3/3
12	Large Shelf	1	3/3
13	Small Shelf	1	2/3
14	Ajustable Shelf	4	2/3
15	Front Baseboard	1	3/3
16	Back Baseboard	1	3/3
17	Large Back Baseboard	1	3/3
18	Top Panel	1	3/3
19	Angled Top Panel	1	3/3
20	Internal Baseboard	1	3/3

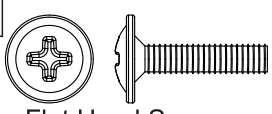
TOOLS REQUIRED

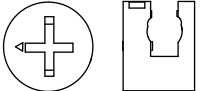
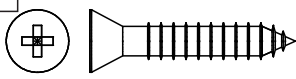
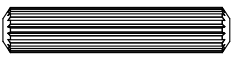
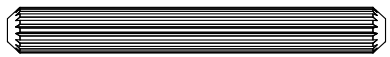
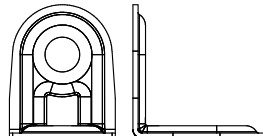
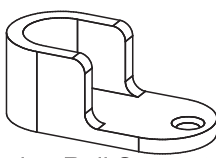
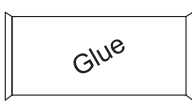
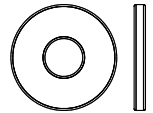

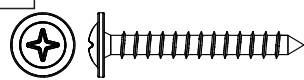
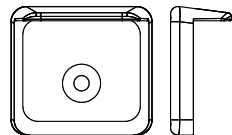
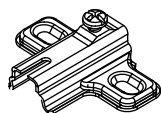
FITTINGS LIST

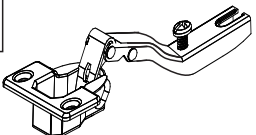
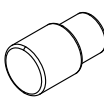
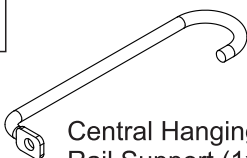
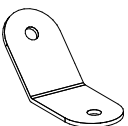
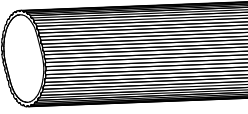
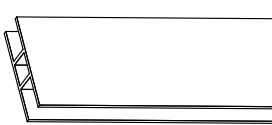
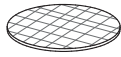
A  Flat Head Screw Ø4,0 x 14mm (53x) +/2	B  Flat Head Screw Ø4,0 x 50mm (29x) +/2	C  Cam Bolt (6x) +/1	
D  Hole Plugs (16x) +/2	E  Flat Head Screw M4 x 20 (5x) +/1	F  Flat Head Screw Ø3,5 x 40mm (5x) +/1	G  Nail 10 x 10 (125x) +/2
H  Cam Nut (12x) +/2	I  Flat Head Screw Ø4,0 x 25mm (13x) +/2	J  Dowel Ø6,0 x 30mm (34x) +/2	K  Dowel Ø6,0 x 40mm (4x) +/1
L  'L' Metallic Support (11x) +/1	M  Hanging Rail Support (2x)	N  Glue (1x)	O  Washer (4x) +/1
P  Strap (2x)	Q  Flat Head Screw Ø3,5 x 30mm (2x) +/1	R  Plastic Foot (12x) +/1	S  Hinge Plate (6x)
T  Handle (2x)	U  Hinge (6x)	V  Shelf Support (18x) +/2	W  Central Hanging Rail Support (1x)
X  Angular Metallic Support (1x)	Y  Hanging Rail (1x)	Z  Back Panel Strip (1x)	A1  Hole Plugs (38x) +/2

TIPS FOR FITTINGS CAM-LOCKS

WHEN FITTING CAM NUT. ENSURE STARTING POSITION IS CORRECT BEFORE YOU INSERT CONNECTING CAM BOLT TURN CLOCKWISE UNTIL SECURE

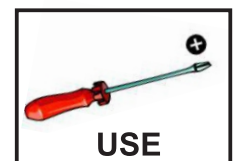
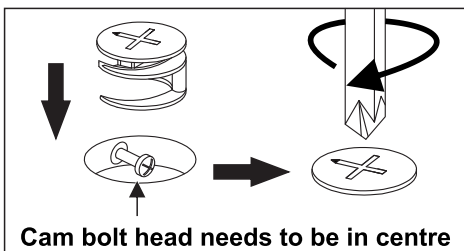
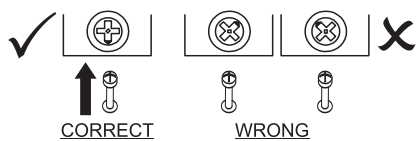

CAMBOLT
 Tighten until shoulder in flush with panel. Do not overtighten or undertighten (see example beside)

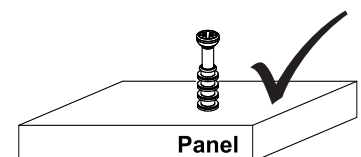
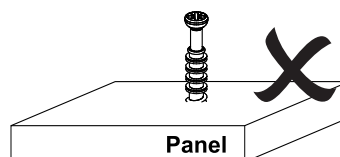
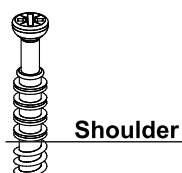

STEP 1

PARTS REQUIRED

2 - ANGLED BASE x1

12 - LARGE SHELF x1

13 - SMALL SHELF x1

19 - ANGLED TOP x1

HARDWARE REQUIRED

J  12

N  01

TOOLS REQUIRED

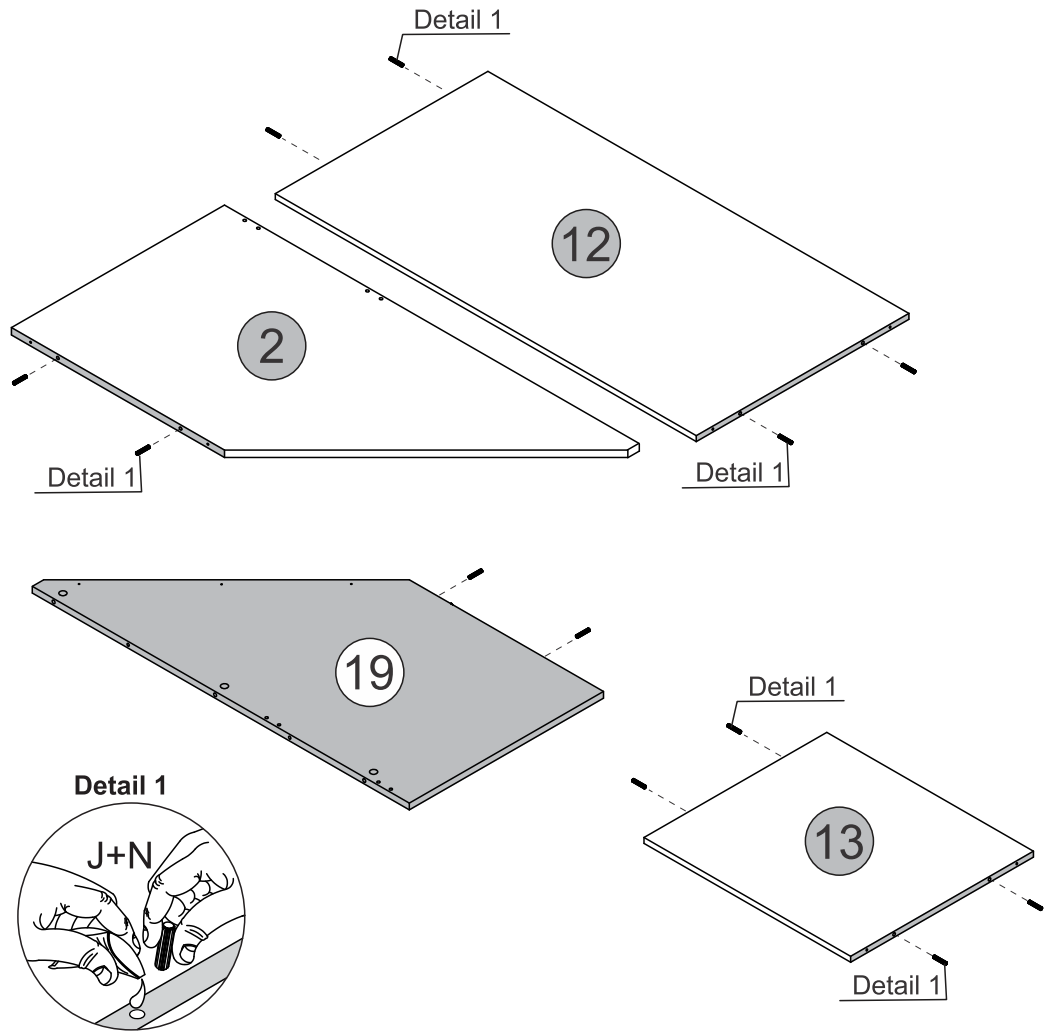
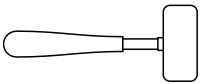

STEP 2

PARTS REQUIRED

1 - RECTANGLE BASE x1

18 - RECTANGLE TOP x1

HARDWARE REQUIRED

J  04

K  04

N  01

TOOLS REQUIRED

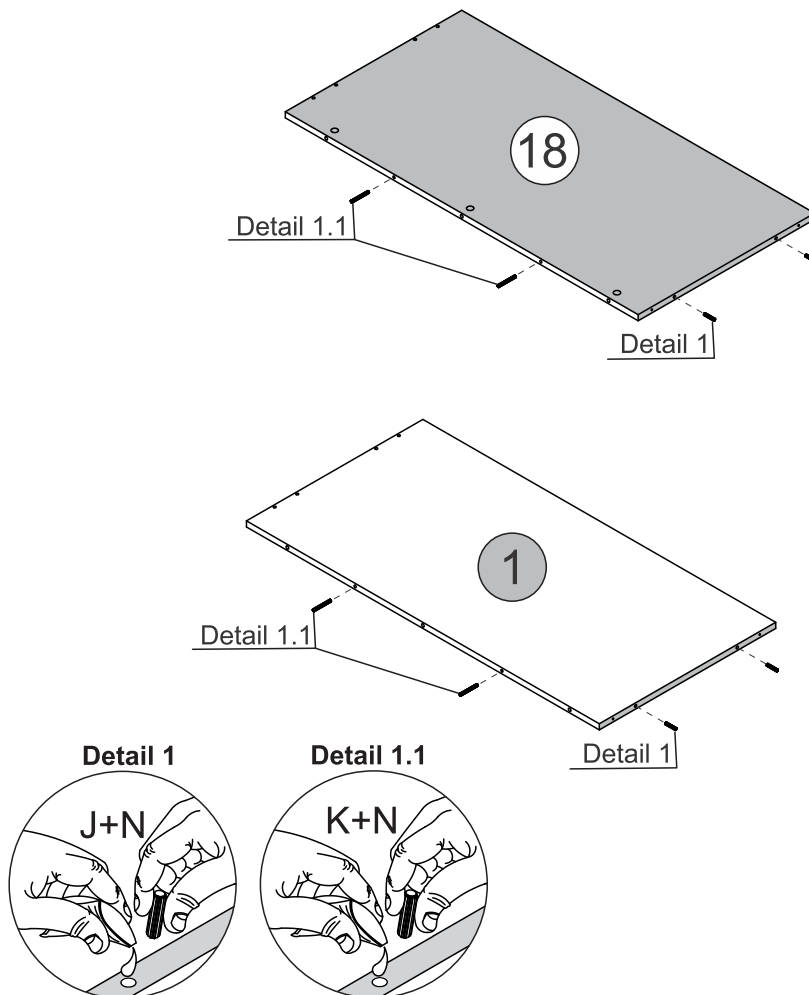
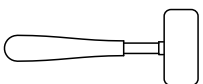

STEP 3

PARTS REQUIRED

15 - FRONT BASEBOARD x1

16 - BACK BASEBOARD x1

17 - LARGE BACK BASEBOARDx1

19 - ANGLED TOP PANEL x1

20 - INTERNAL BASEBOARD x1

HARDWARE REQUIRED

A  12
Ø4,0 x 14mm

L  11

X  01

TOOLS REQUIRED

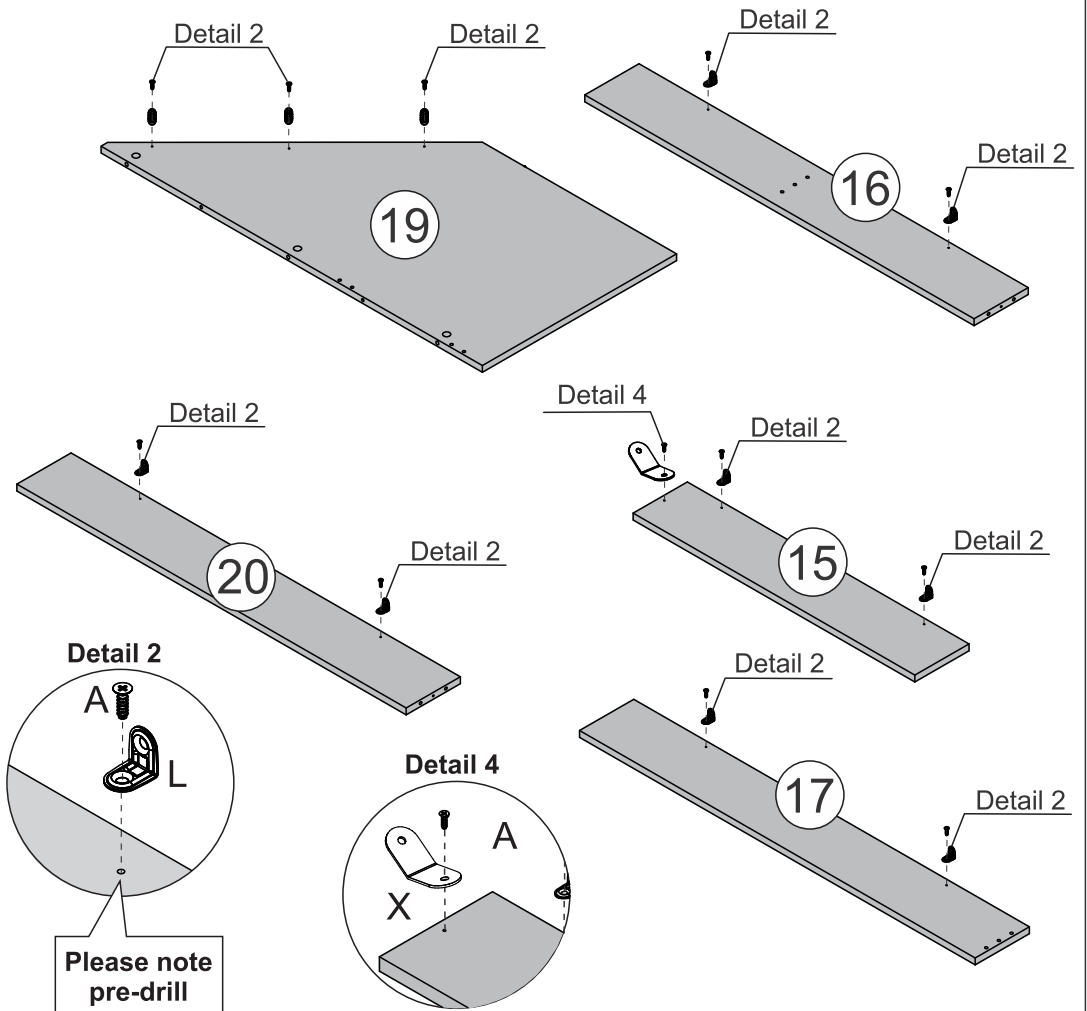
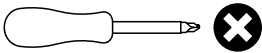

STEP 4

PARTS REQUIRED

15 - FRONT BASEBOARD x1

16 - BACK BASEBOARD x1

17 - LARGE BACK BASEBOARDx1

20 - INTERNAL BASEBOARD x1

HARDWARE REQUIRED

G  08

J  10

N  01

R  08

TOOLS REQUIRED

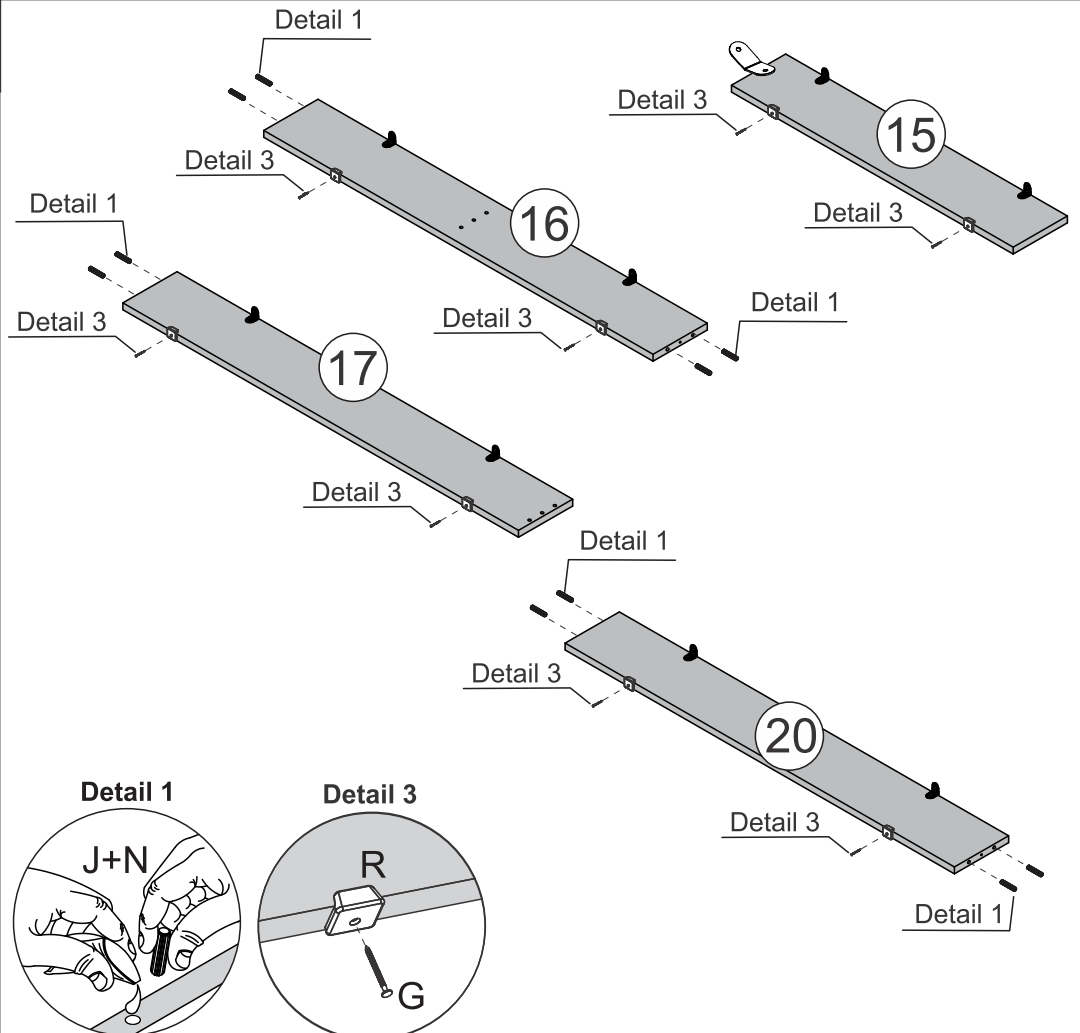
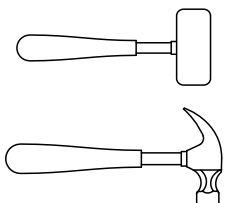

STEP 5

PARTS REQUIRED

8 - LEFT SIDE PANEL x1

HARDWARE REQUIRED

A  06
Ø4,0 x 14mm

G  02

R  02

S  03

V  08

TOOLS REQUIRED

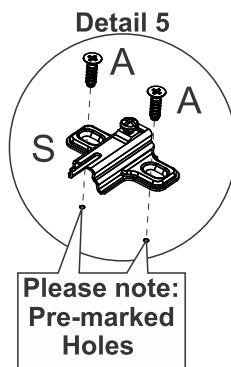
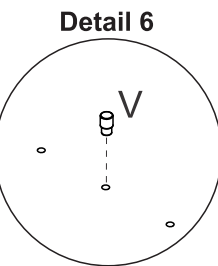
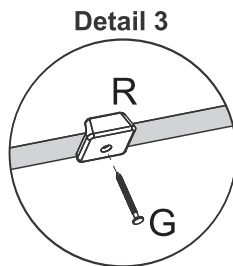
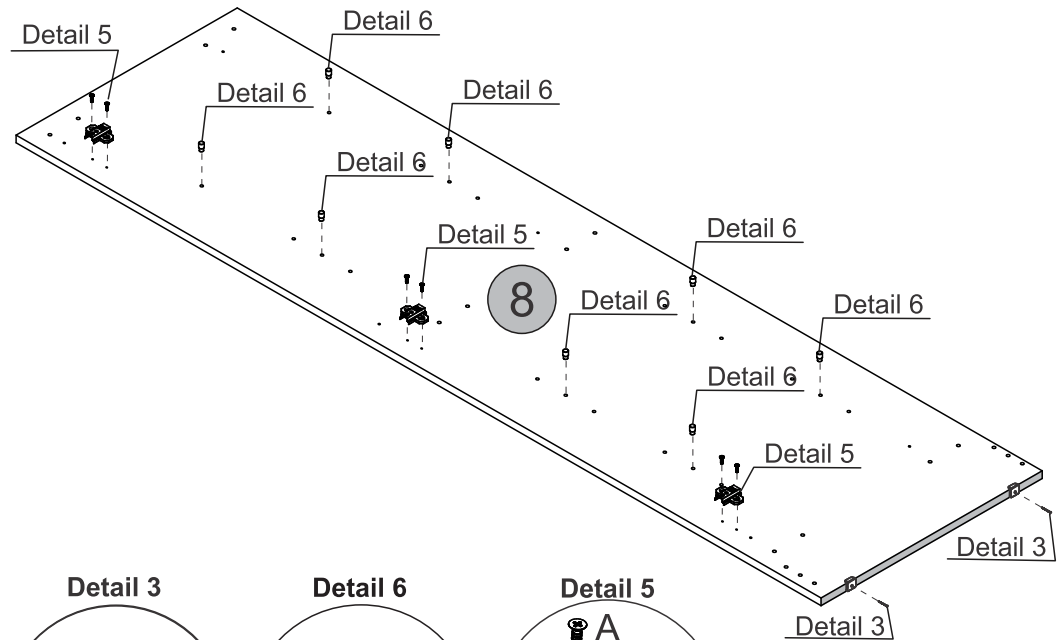
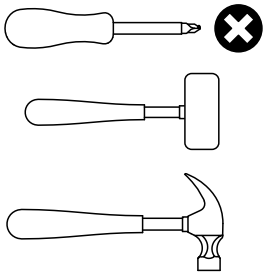

STEP 6

PARTS REQUIRED

7 - RIGHT SIDE PANEL x1

HARDWARE REQUIRED

A  08
Ø4,0 x 14mm

G  02

M  01

R  02

S  03

TOOLS REQUIRED

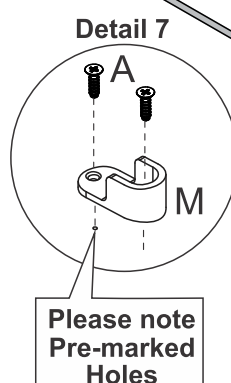
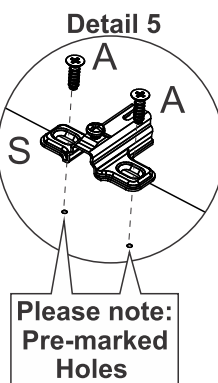
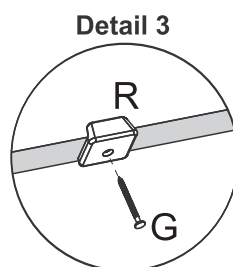
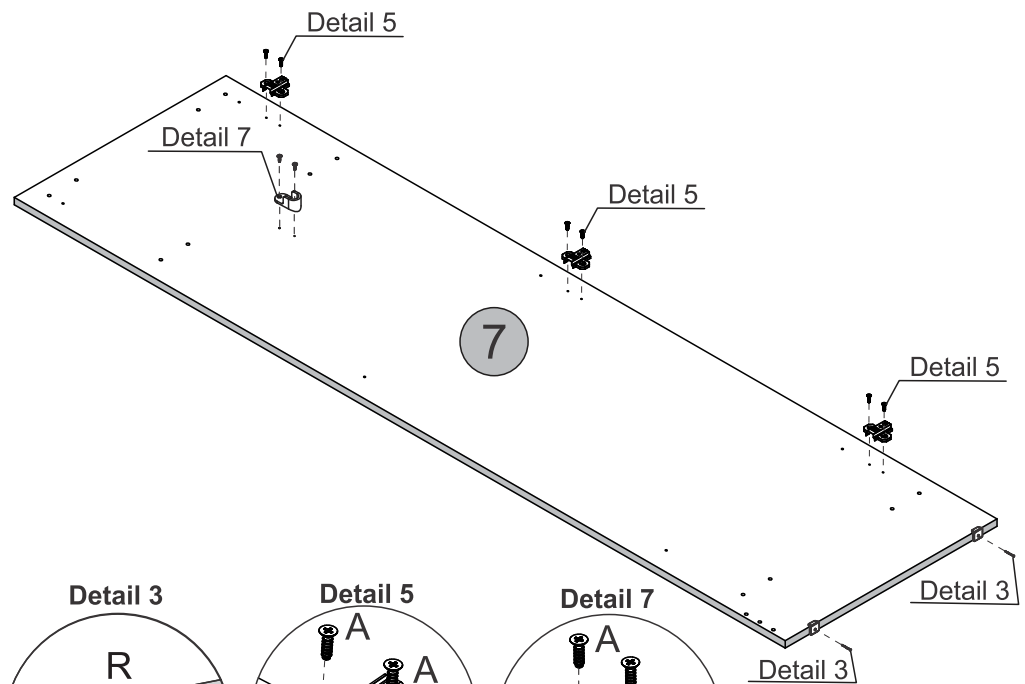
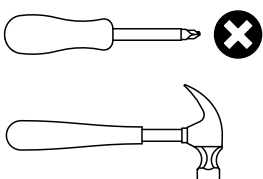

STEP 7

PARTS REQUIRED

6 - DIVISION PANEL x1

HARDWARE REQUIRED

J  04

N  01

V  10

TOOLS REQUIRED

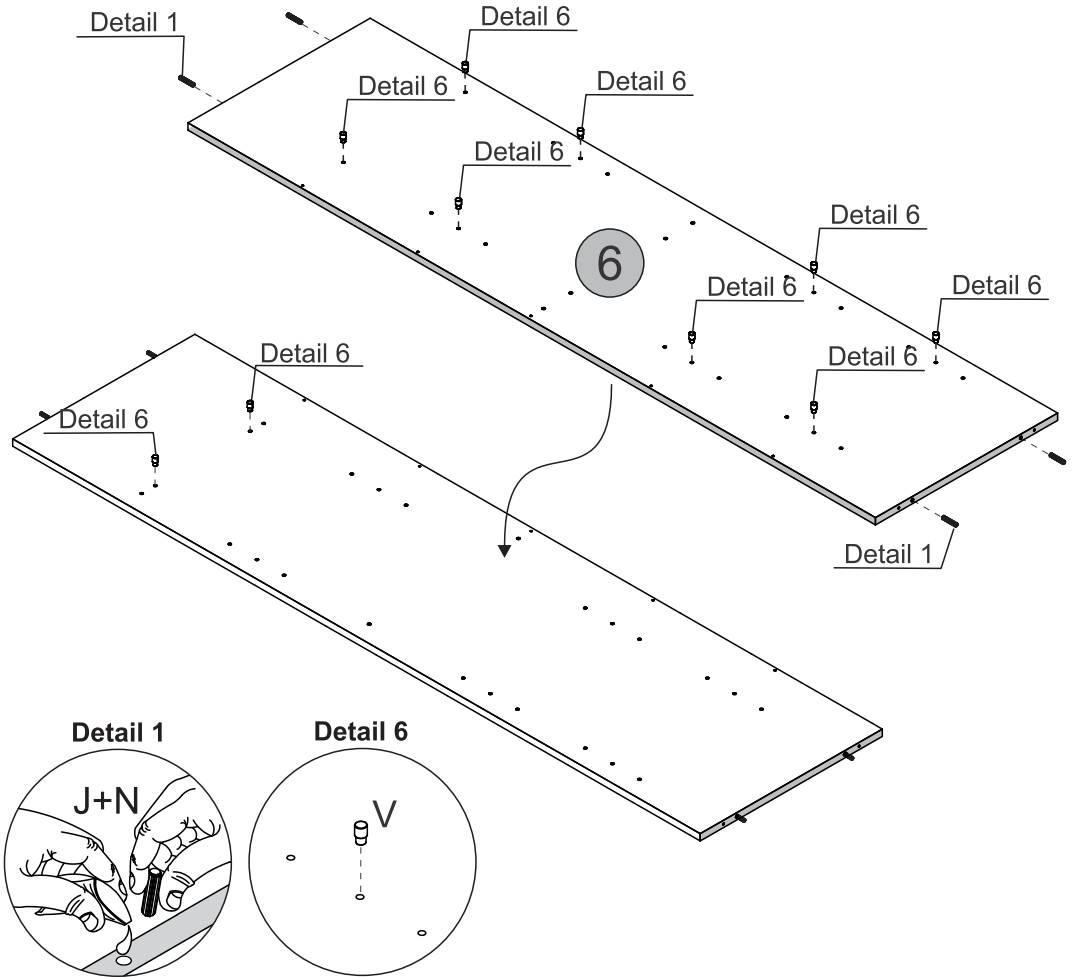
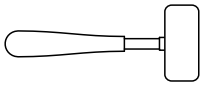

STEP 8

PARTS REQUIRED

3 - BACKBOARD x1

HARDWARE REQUIRED

A  Ø4,0 x 14mm 02

J  04

M  01

TOOLS REQUIRED

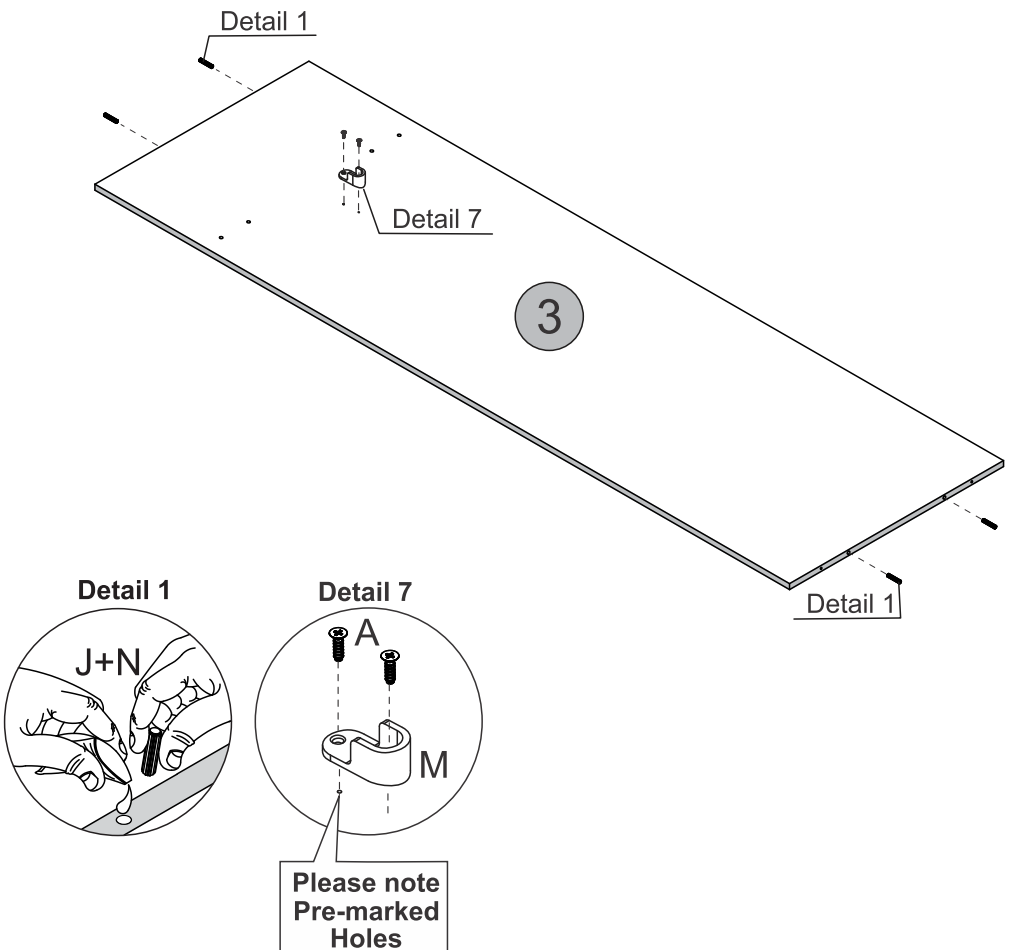
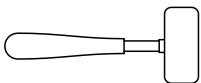
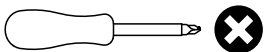

STEP 9

PARTS REQUIRED

1 - BASE PANEL x1

3 - BACKBOARD x1

12 - LARGE SHELF x1

HARDWARE REQUIRED

B  04
Ø4,0 x 50mm

N  01

TOOLS REQUIRED

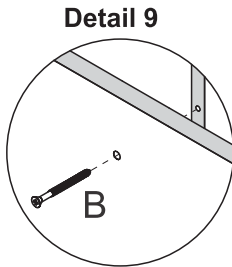
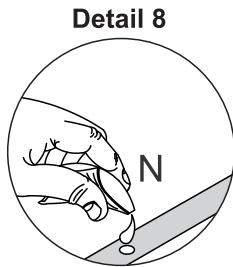
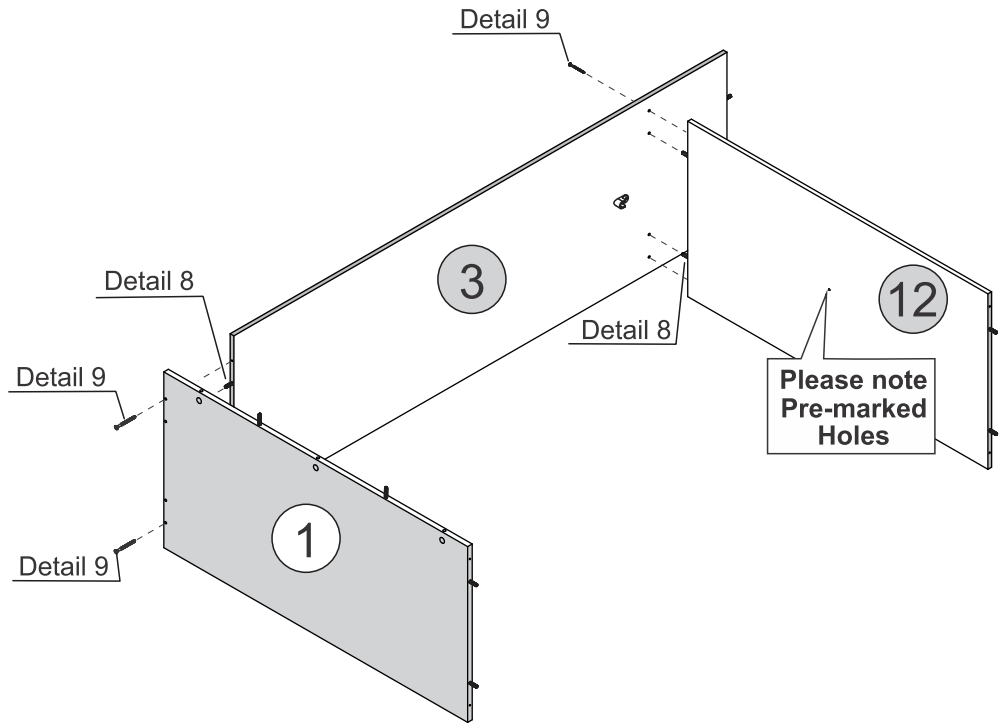
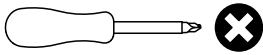

STEP 10

PARTS REQUIRED

7 - RIGHT SIDE PANEL x1

18 - TOP PANEL x1

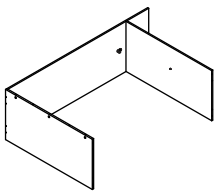

HARDWARE REQUIRED

B  08
Ø4,0 x 50mm

N  01

TOOLS REQUIRED

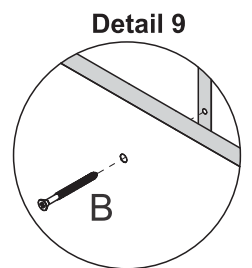
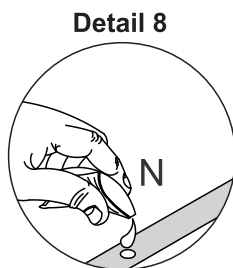
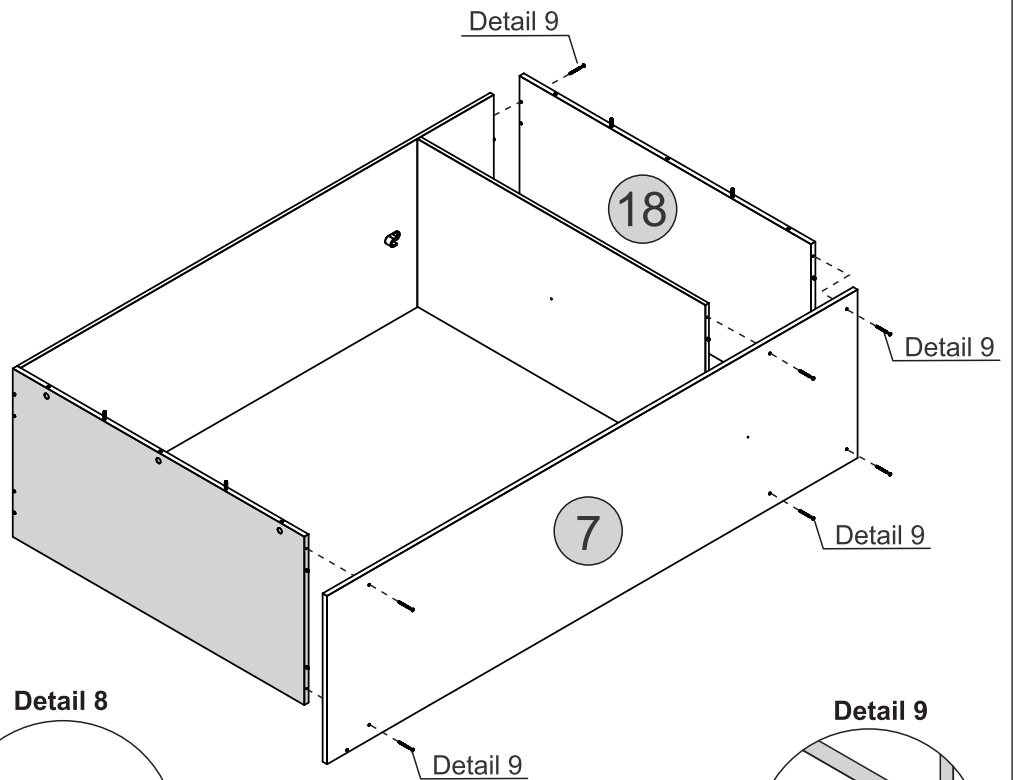
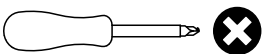

STEP 11

PARTS REQUIRED

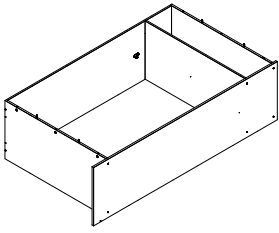

HARDWARE REQUIRED

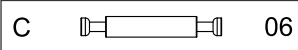

TOOLS REQUIRED

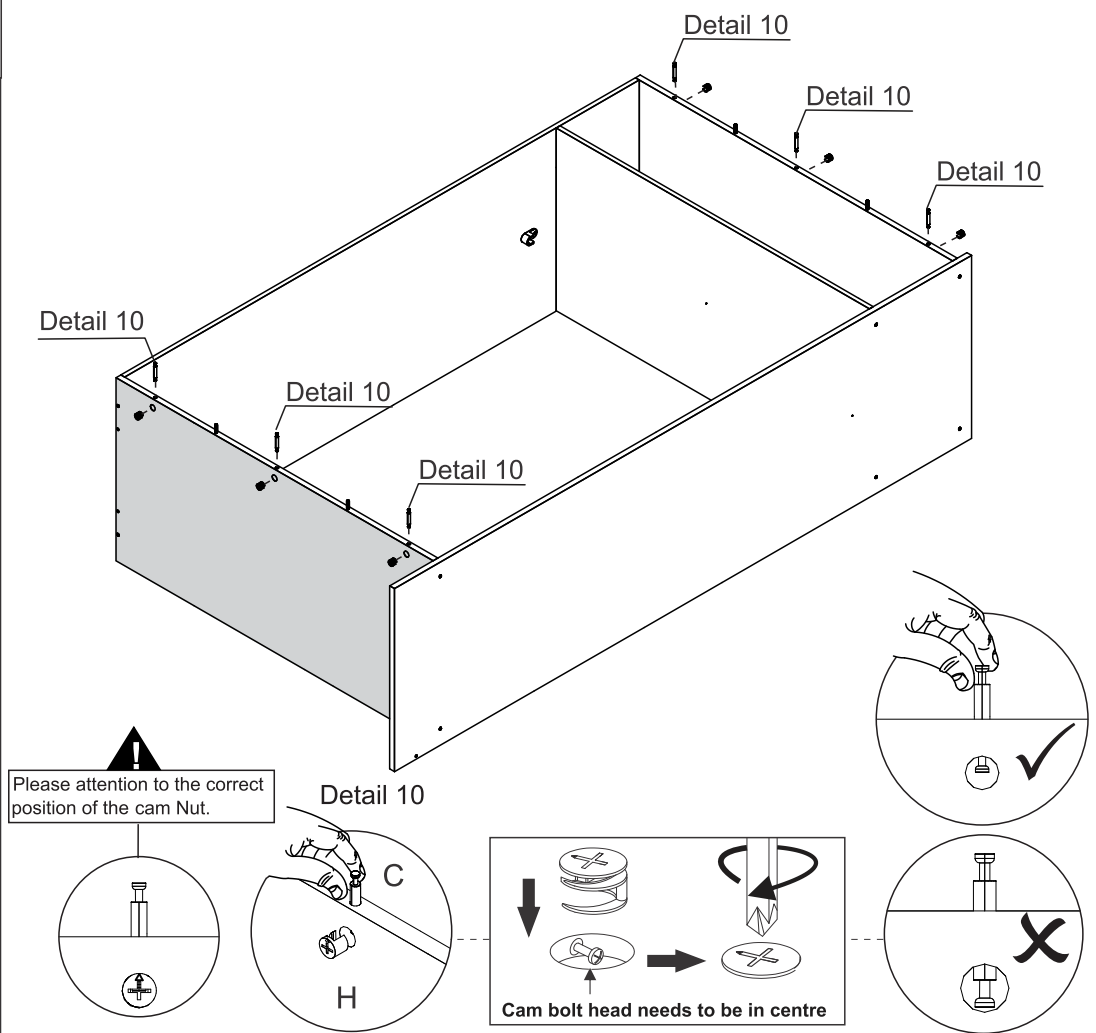
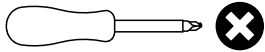

STEP 12

PARTS REQUIRED

2 - ANGLED BASE PANEL	x1
-----------------------	----

19 - ANGLE TOP PANEL	x1
----------------------	----

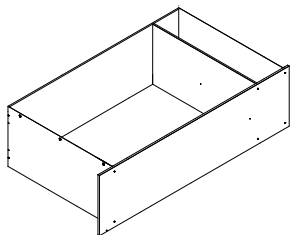

HARDWARE REQUIRED

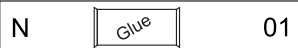

TOOLS REQUIRED

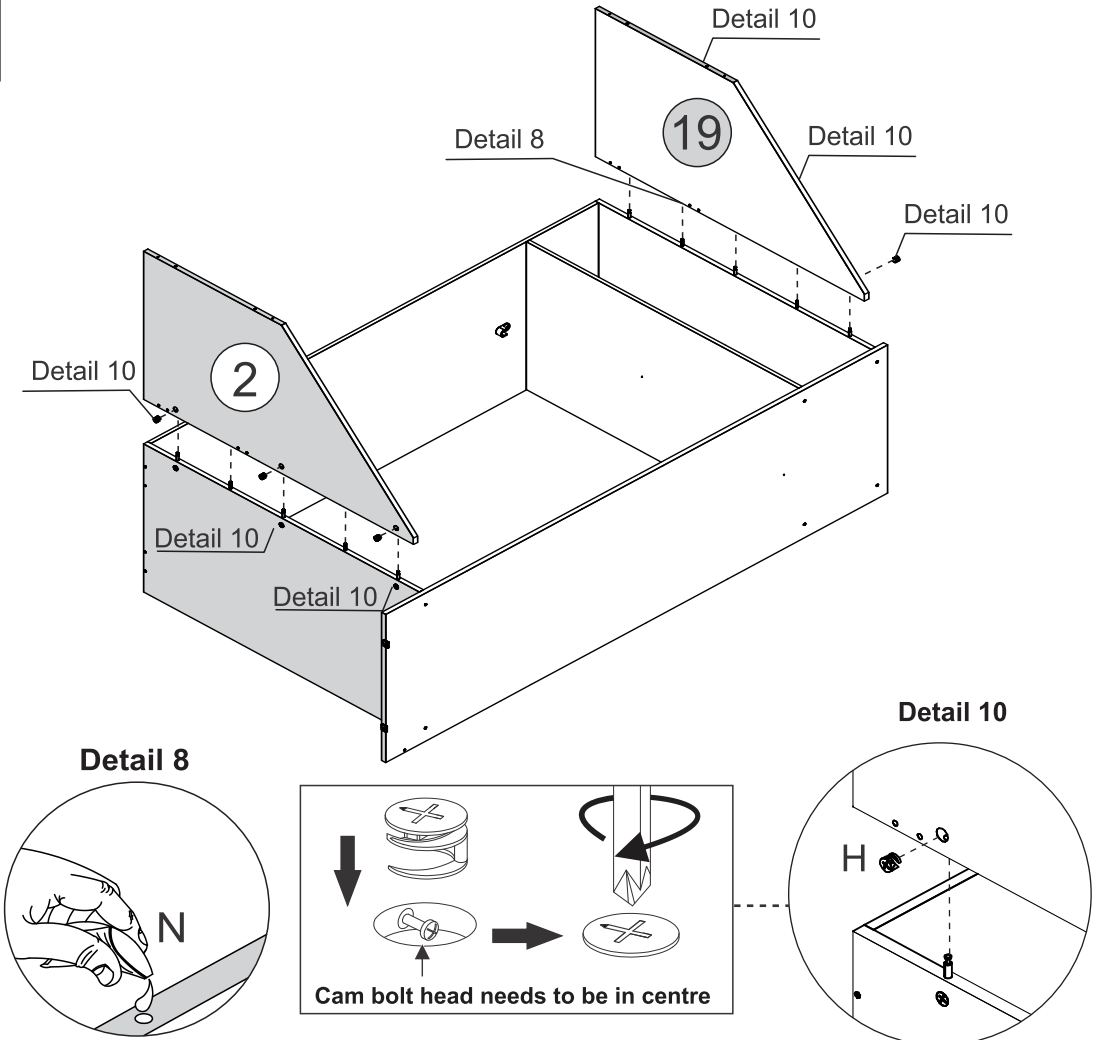
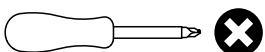

STEP 13

PARTS REQUIRED

6 - DIVISION PANEL x1

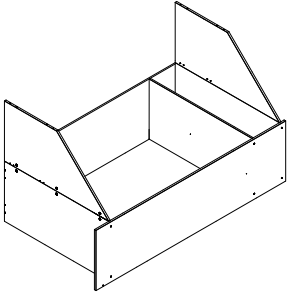

HARDWARE REQUIRED

B  04
Ø4,0 x 50mm

TOOLS REQUIRED

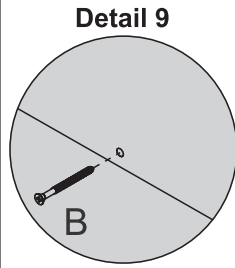
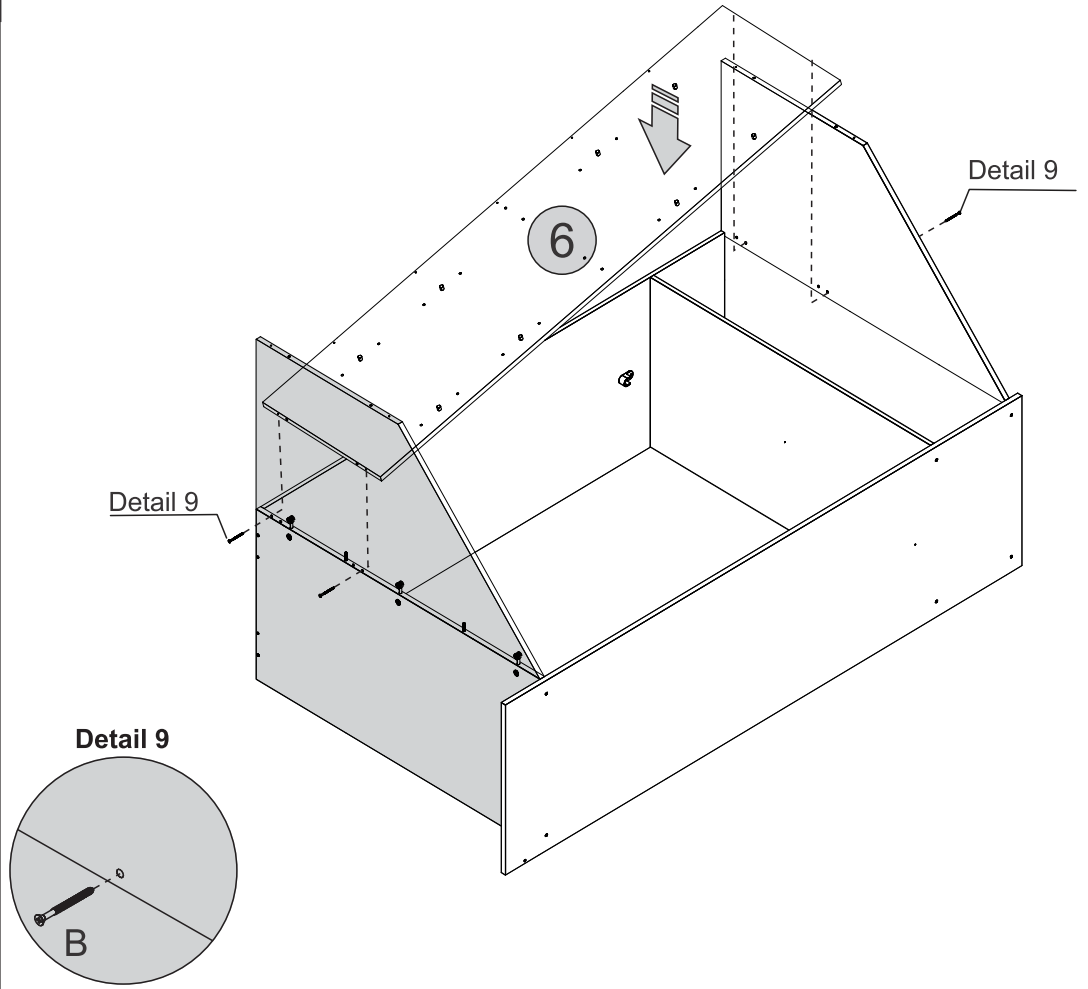
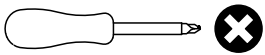

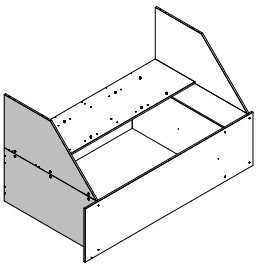

STEP 14

PARTS REQUIRED



HARDWARE REQUIRED

A  01
Ø4,0 x 14mm

F  05
Ø3,5 x 40mm

W  01

TOOLS REQUIRED

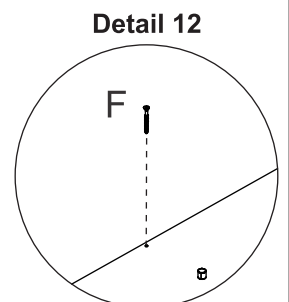
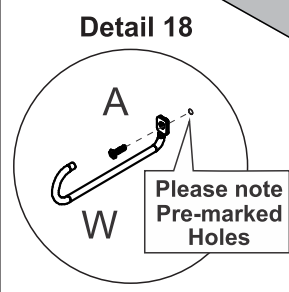
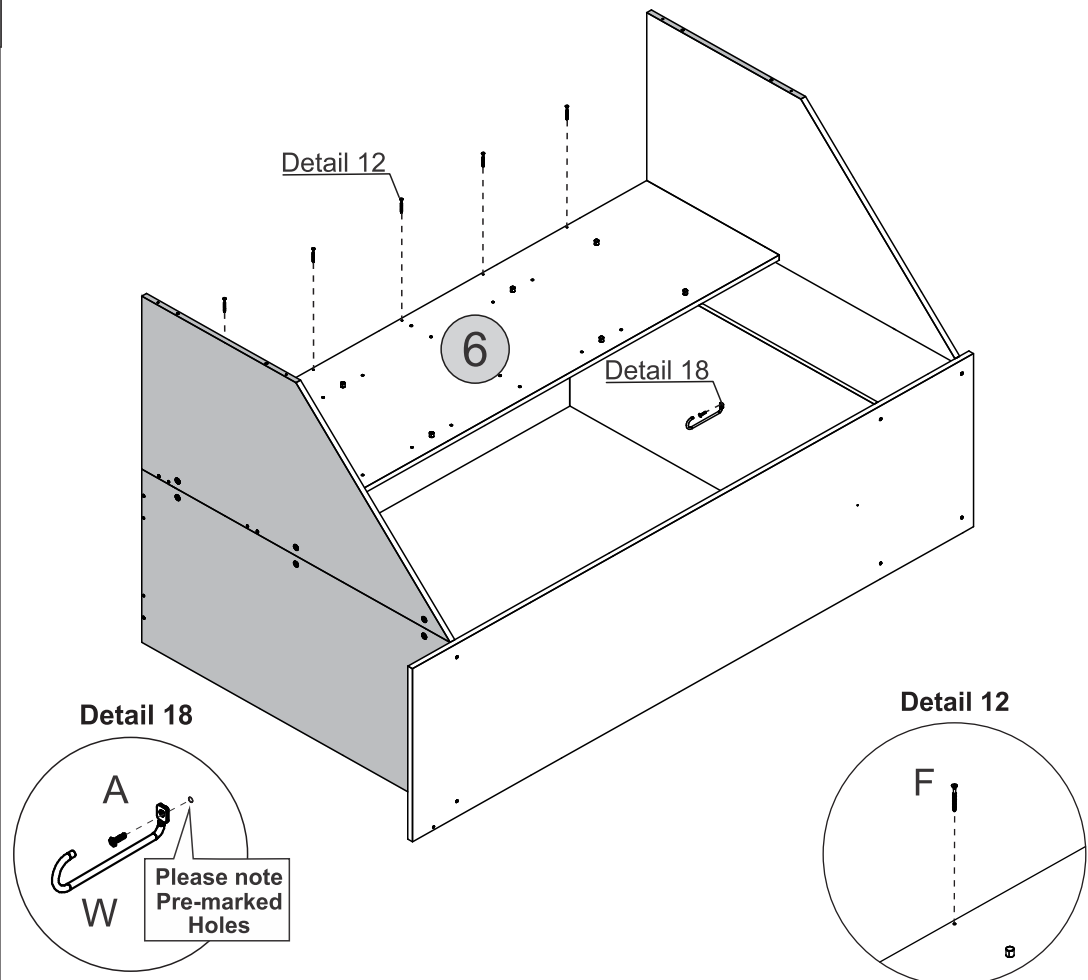
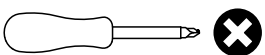

STEP 15

PARTS REQUIRED

16 - BACK BASEBOARD x1

17 - LARGE BACK BASEBOARD x1

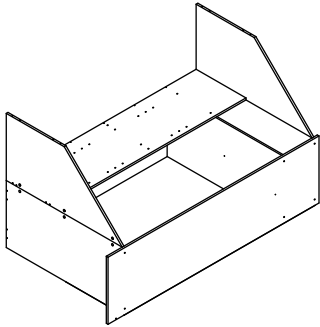

HARDWARE REQUIRED

B  Ø4,0 x 50mm 02

N  01

TOOLS REQUIRED

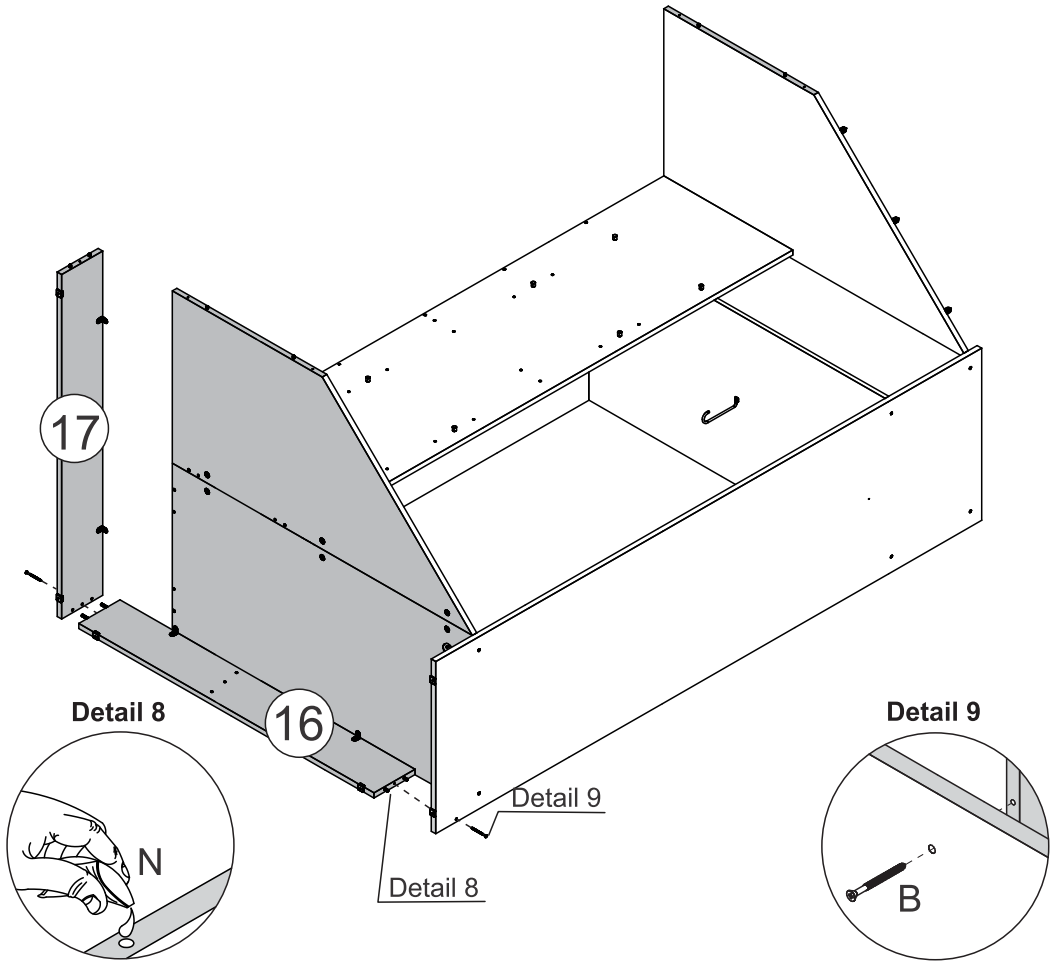
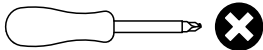

STEP 16

PARTS REQUIRED

8 - LEFT SIDE PANEL x1

13 - SMALL SHELF x1

20 - INTERNAL BASEBOARD x1

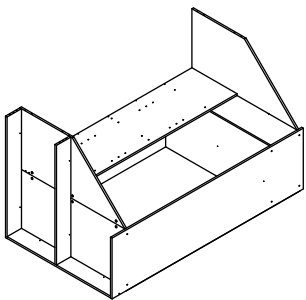

HARDWARE REQUIRED

B  Ø4,0 x 50mm 08

N  01

TOOLS REQUIRED

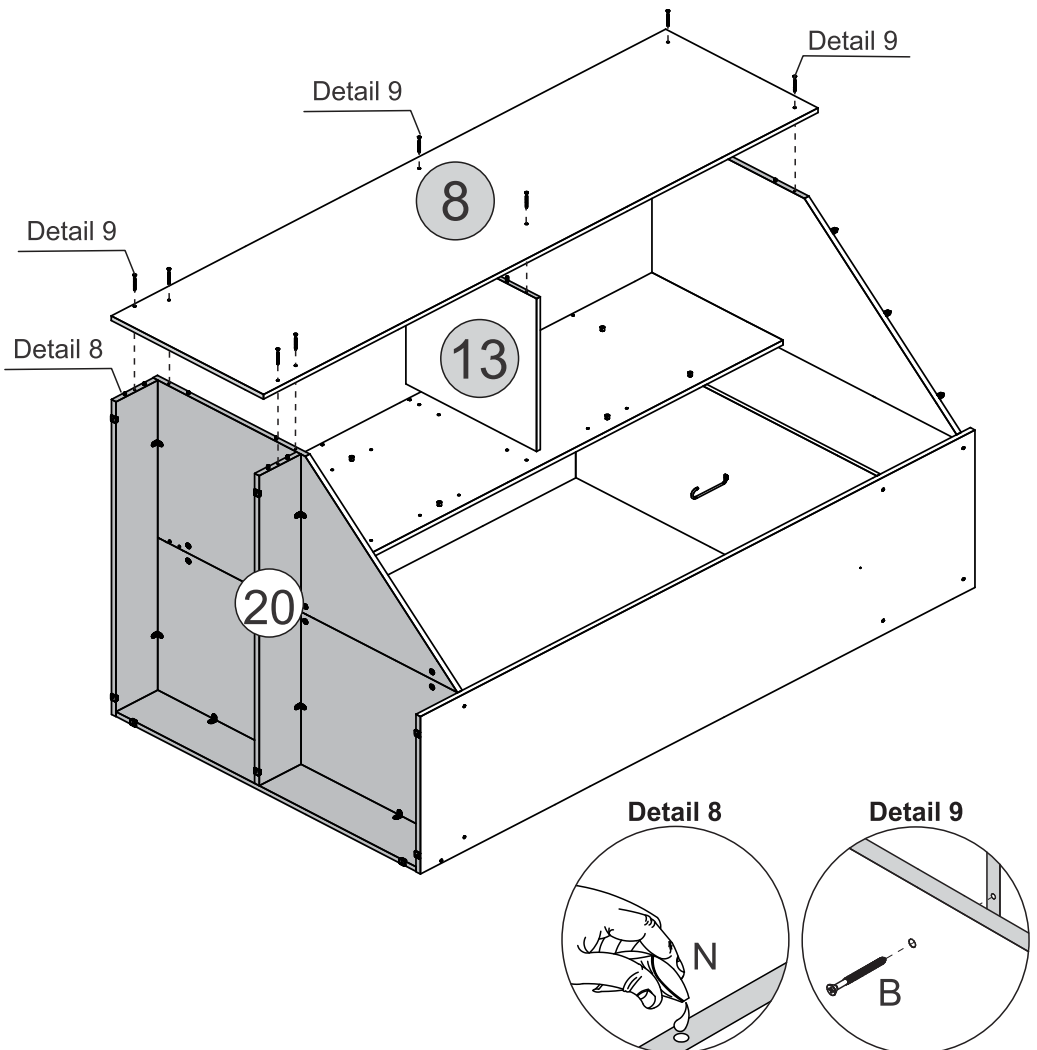
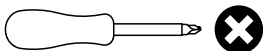

STEP 17

PARTS REQUIRED

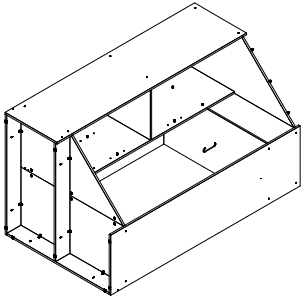

HARDWARE REQUIRED

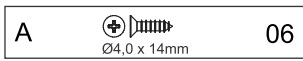

TOOLS REQUIRED

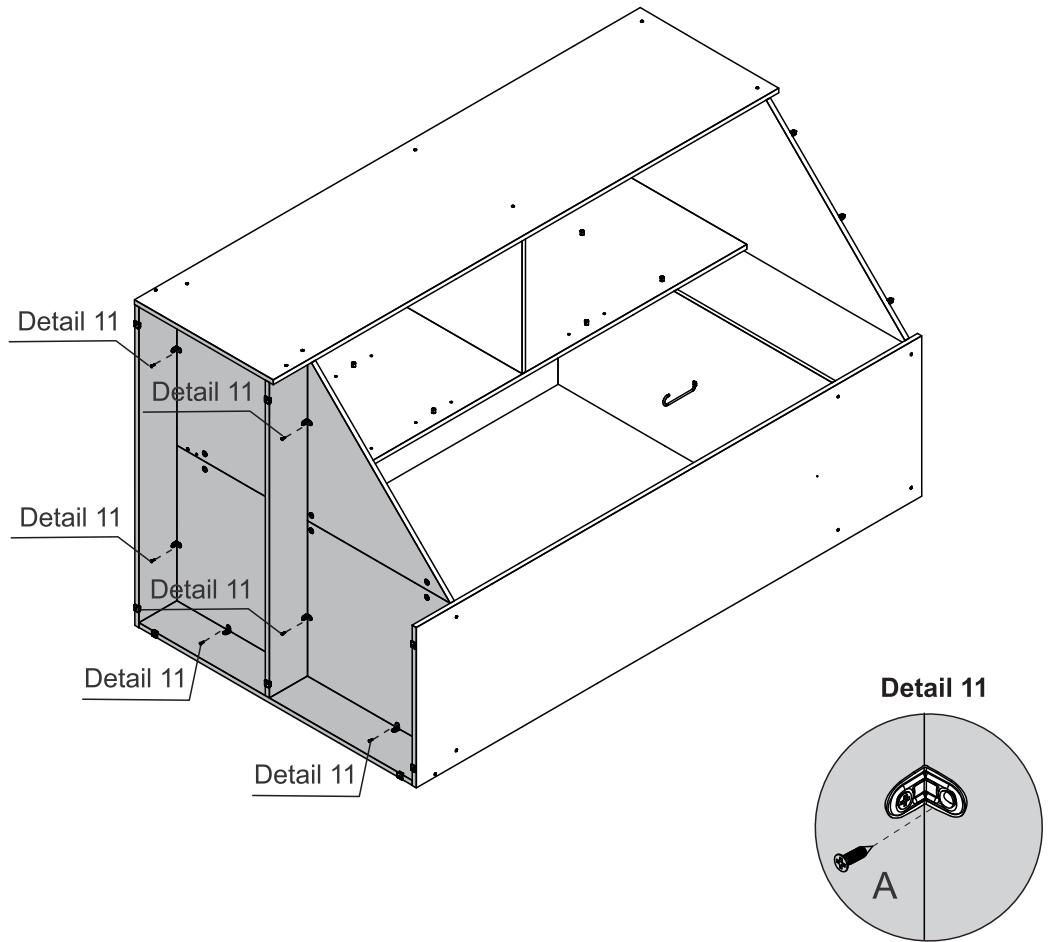
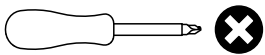

STEP 18

PARTS REQUIRED

11 - UPPER FRAME x1

15 - FRONT BASEBOARD x1

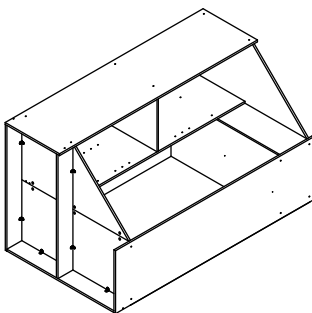

HARDWARE REQUIRED

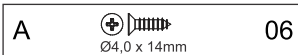

TOOLS REQUIRED

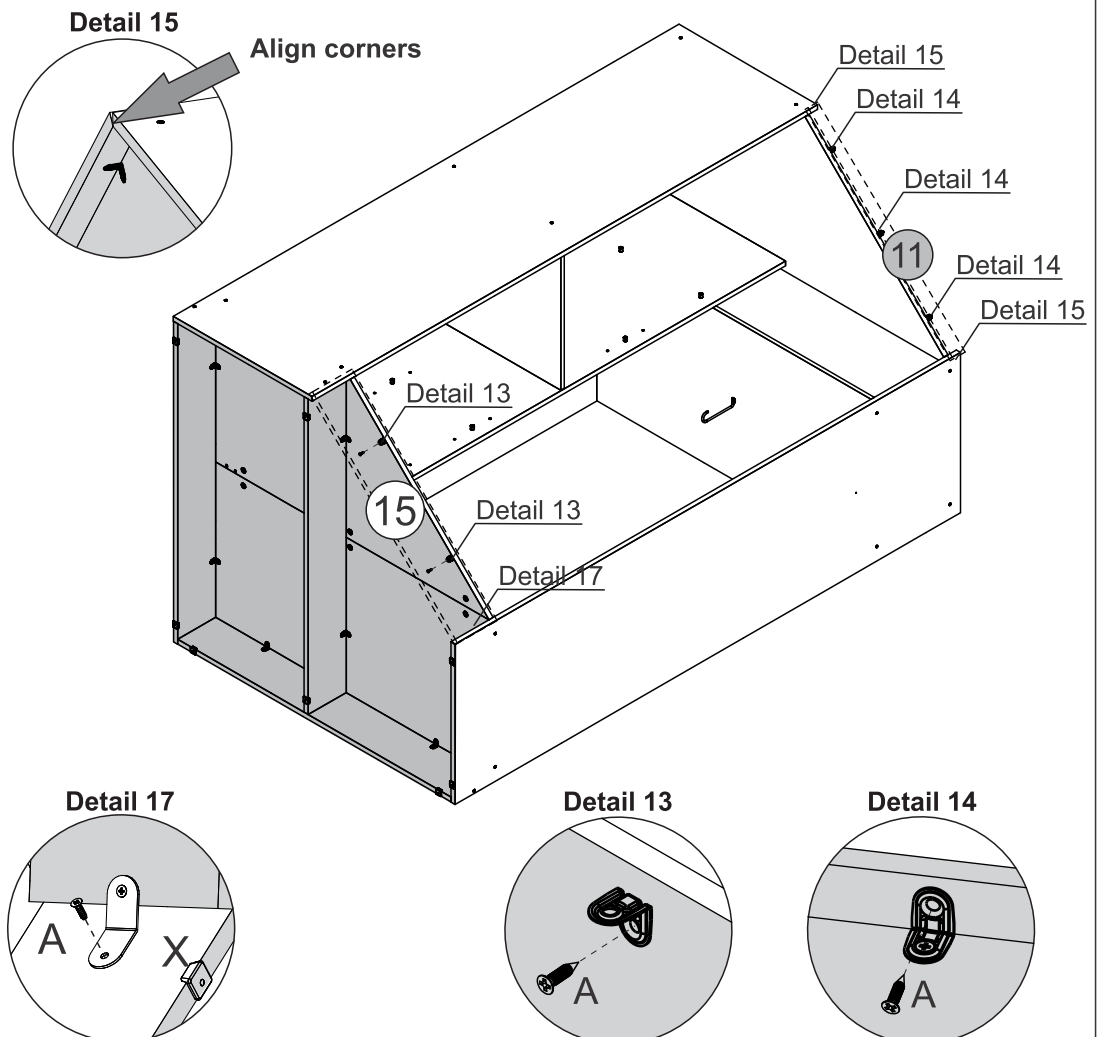
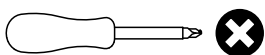

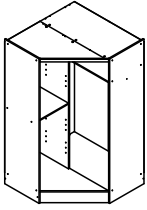

STEP 19

PARTS REQUIRED



HARDWARE REQUIRED

B	 Ø4,0 x 50mm	02
Y		01

TOOLS REQUIRED

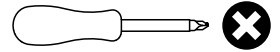

Detail 23

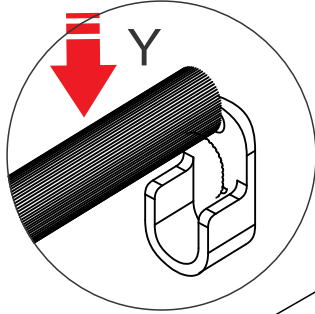

Detail 9

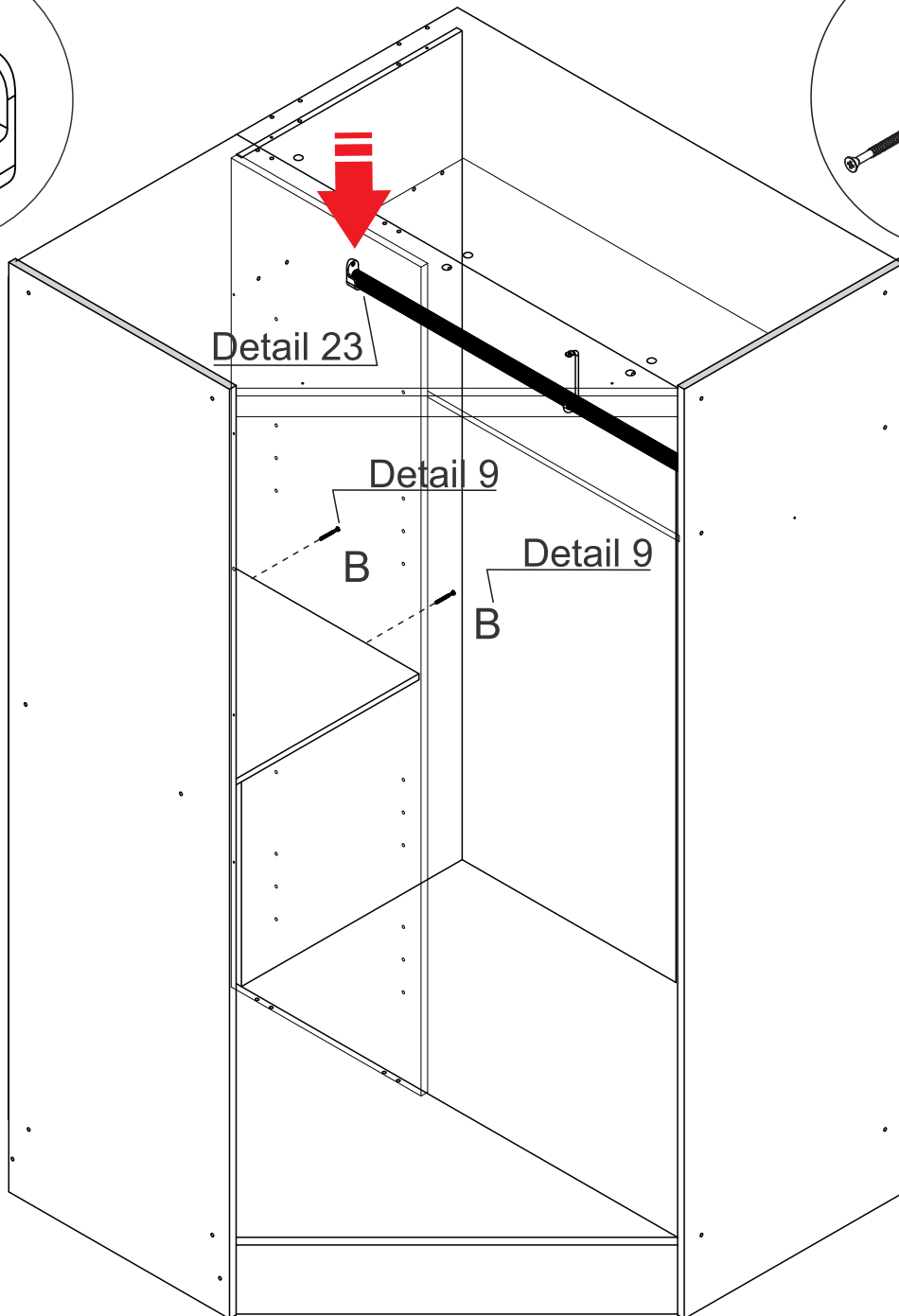
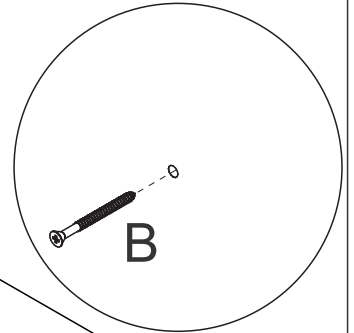

STEP 20

PARTS REQUIRED

4 - LARGE BACK PANEL x1

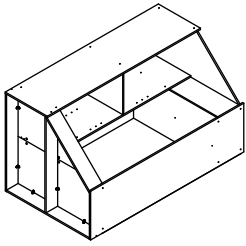

HARDWARE REQUIRED

B  01
Ø4,0 x 50mm

G  22

TOOLS REQUIRED

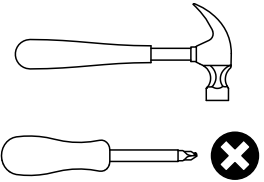

* For your future reference
Order Number should be here

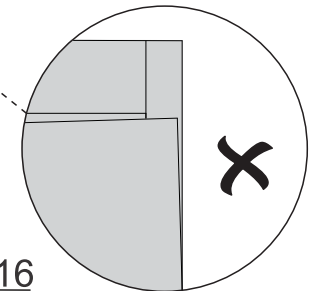
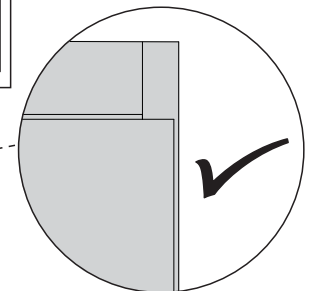
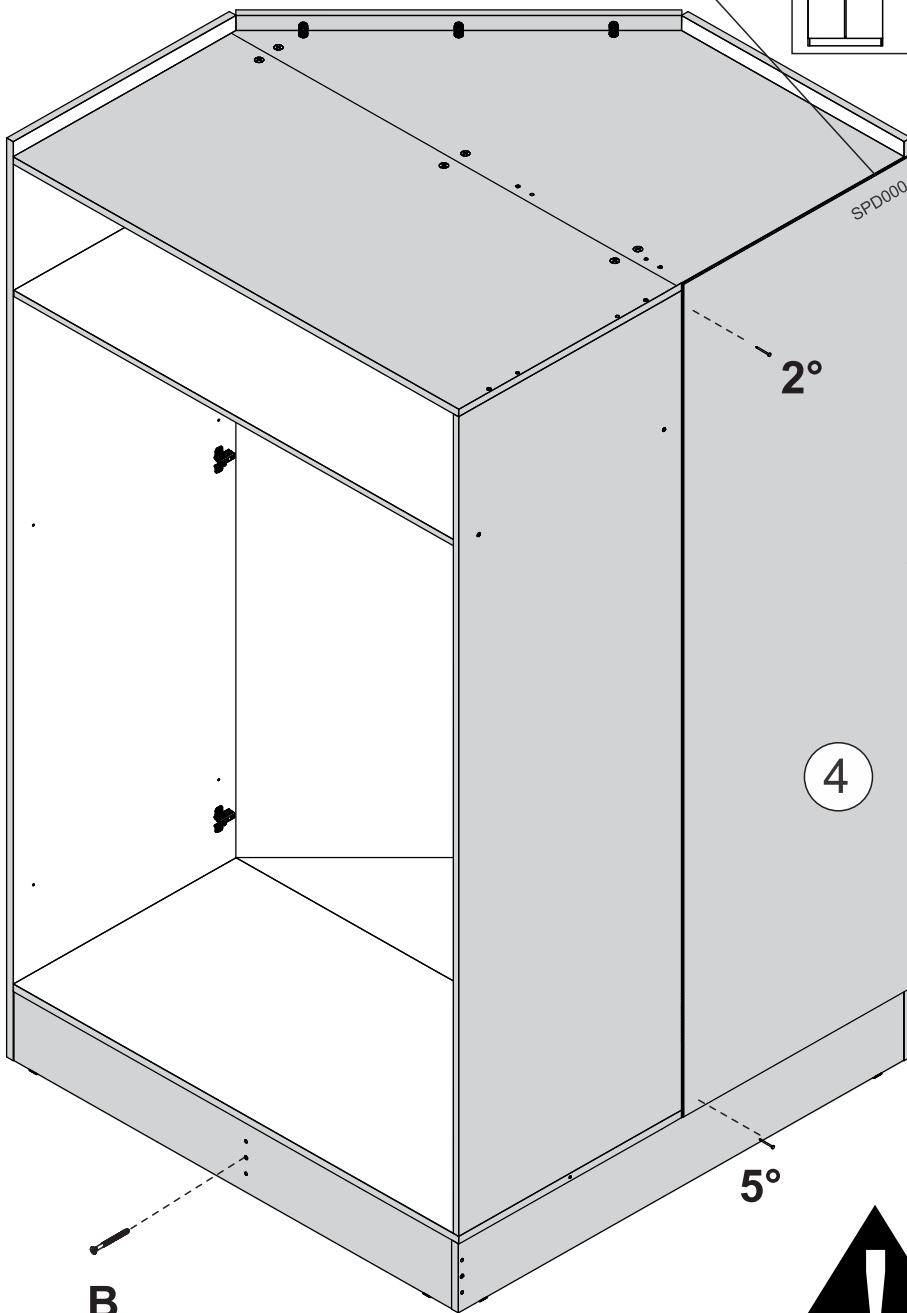
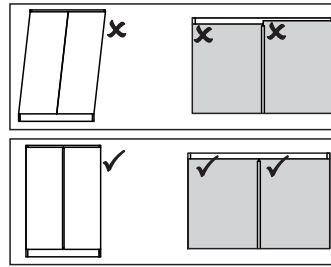

Detail 16

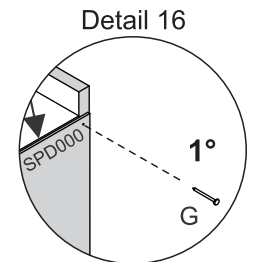

Detail 9

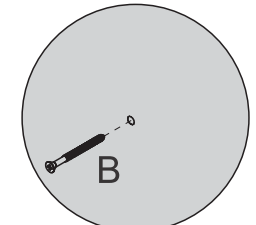

ATTACH THE FIRST NAILS
IN THE ORDER SHOWN

STEP 21

PARTS REQUIRED

5 - SMALL BACK PANEL x2

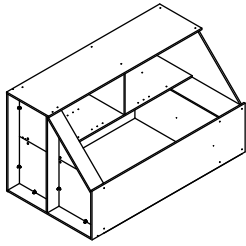

HARDWARE REQUIRED

G  82

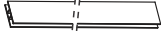
Z  01

TOOLS REQUIRED

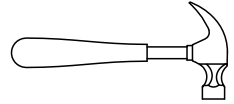

ATTACH THE FIRST 5 NAILS, THEN INSERT THE BACK PANEL STRIP AND FIT THE OTHER BACK PANEL, ATTACH THE OTHER 5 NAILS AND FINISH BY ATTACHING THE REST OF THE NAILS TO THE PRODUCT(NEXT STEP).

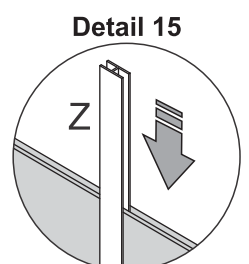
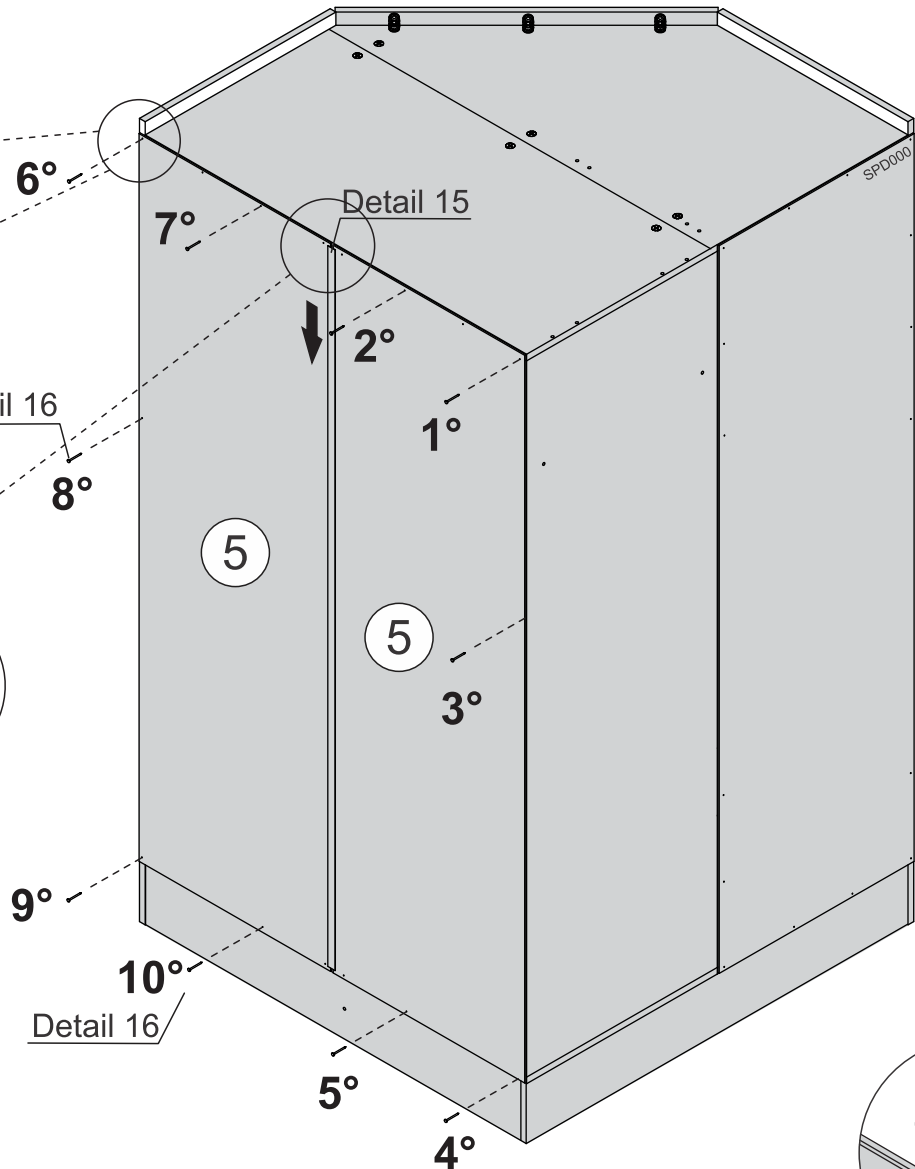
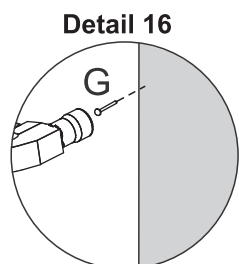
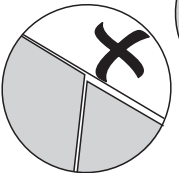
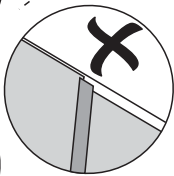
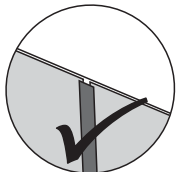
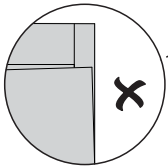
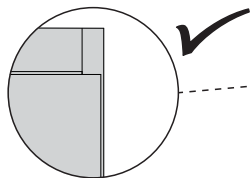
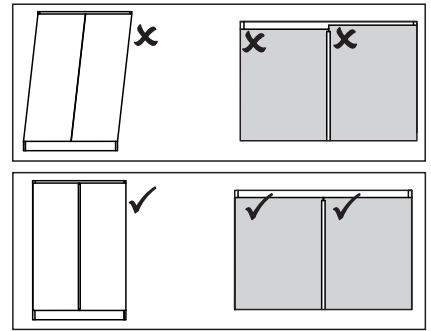

STEP 22

PARTS REQUIRED

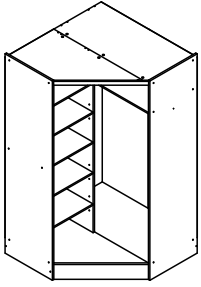

HARDWARE REQUIRED



TOOLS REQUIRED

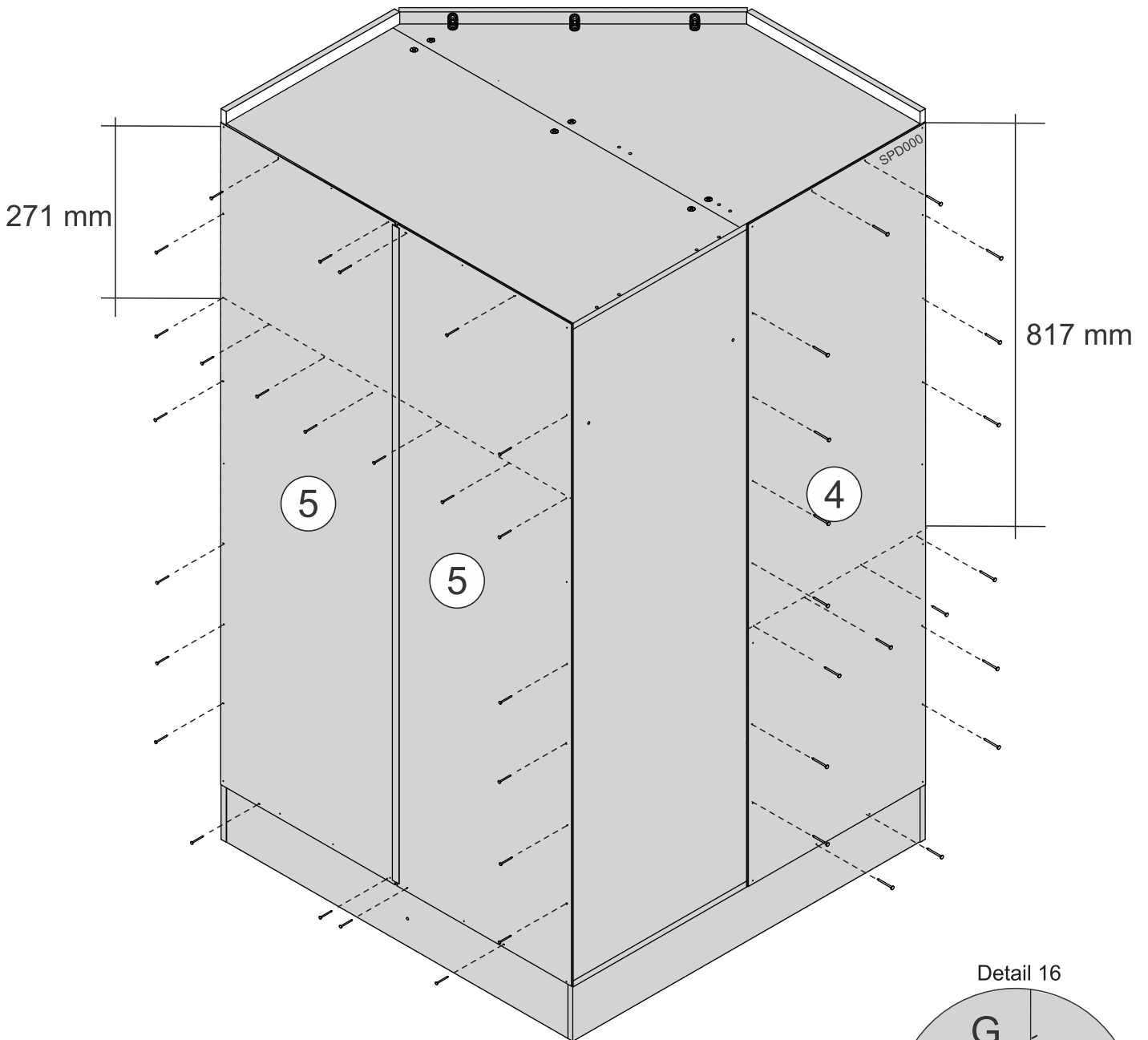
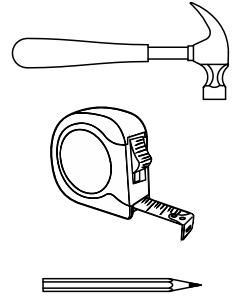

Detail 16

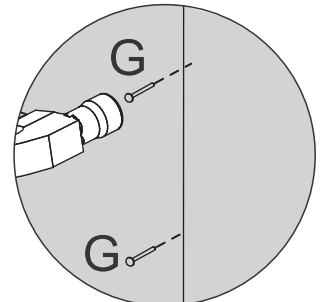

STEP 23

PARTS REQUIRED

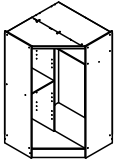

HARDWARE REQUIRED

D		16
A1		34

14 - ADJUSTABLE SHELF x4

Detail 20

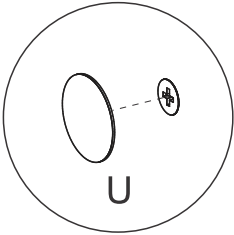

Detail 24

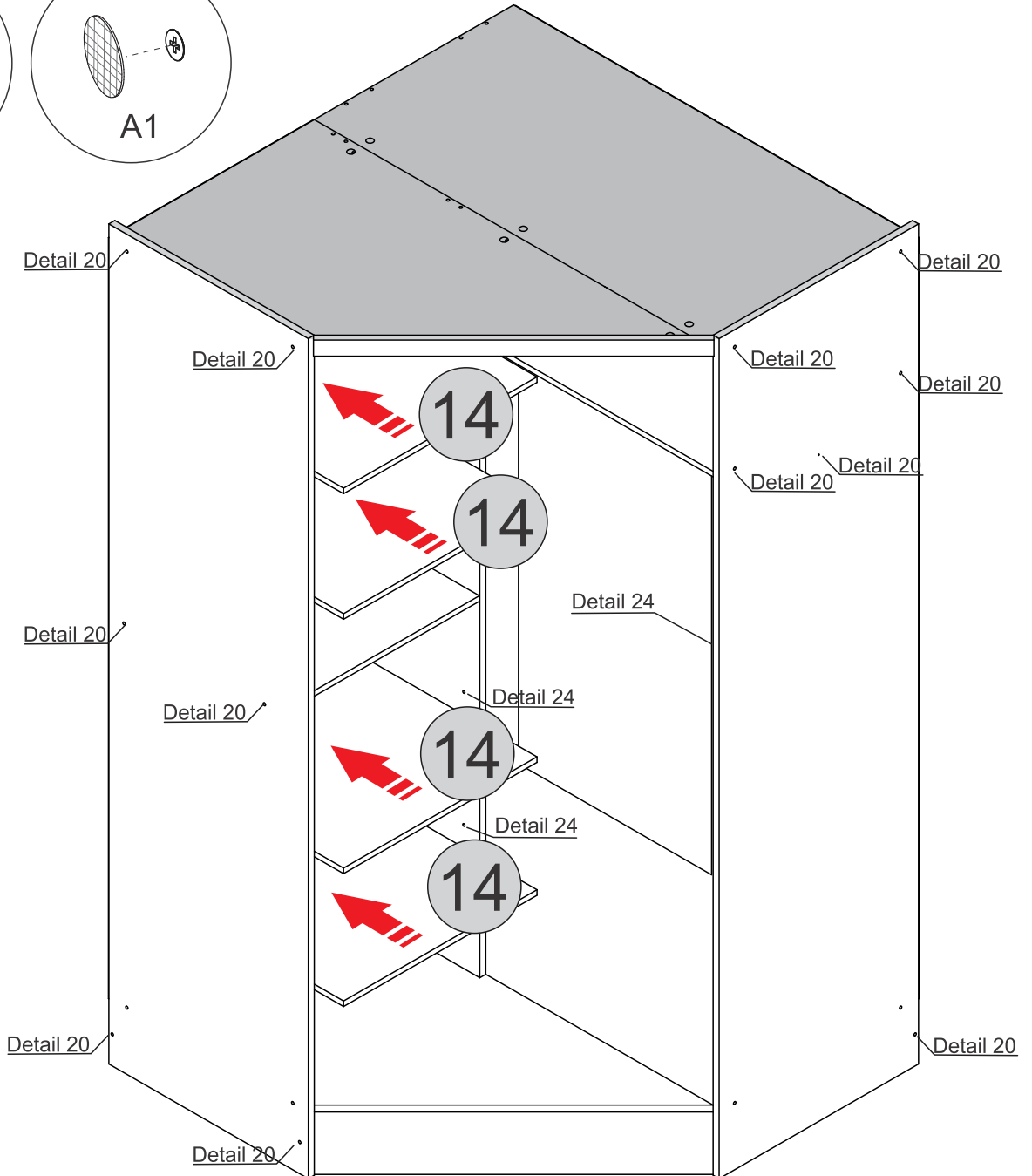
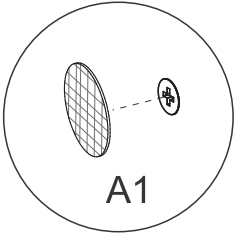

STEP 24

PARTS REQUIRED

9 - RIGHT DOOR x1

10 - LEFT DOOR x1

HARDWARE REQUIRED

A  12
Ø4,0 x 14mm

U  06

TOOLS REQUIRED

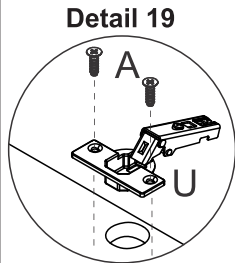
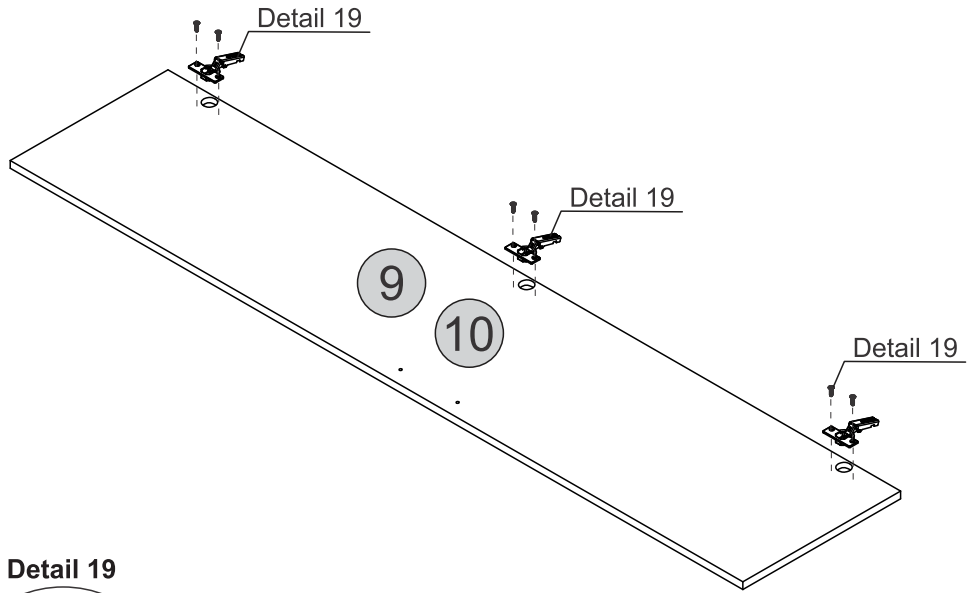
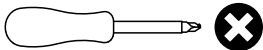

STEP 25

PARTS REQUIRED

9 - RIGHT DOOR x1

10 - LEFT DOOR x1

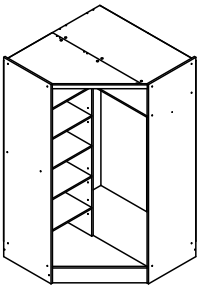

TOOLS REQUIRED

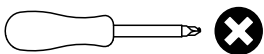

!
Please note the top or bottom edges of the doors are labelled LEFT or RIGHT to make them easier to identify when assembling.

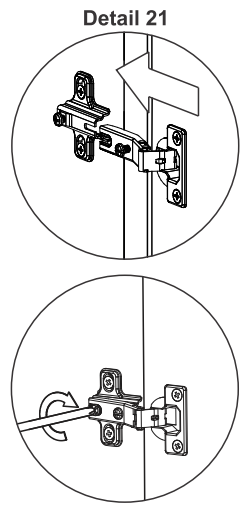
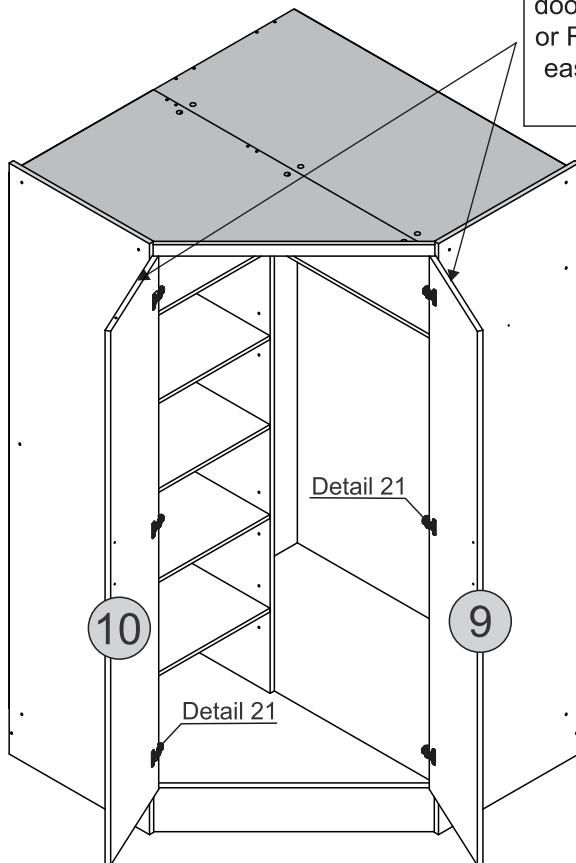

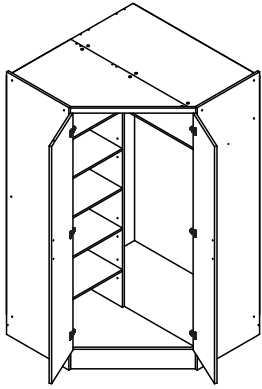

STEP 26

PARTS REQUIRED



HARDWARE REQUIRED

E	 M4x20mm	04
T		02

TOOLS REQUIRED

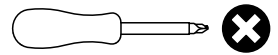

TIP
If desired, after assembly use an alcohol cleaner to erase the number printed on the parts.

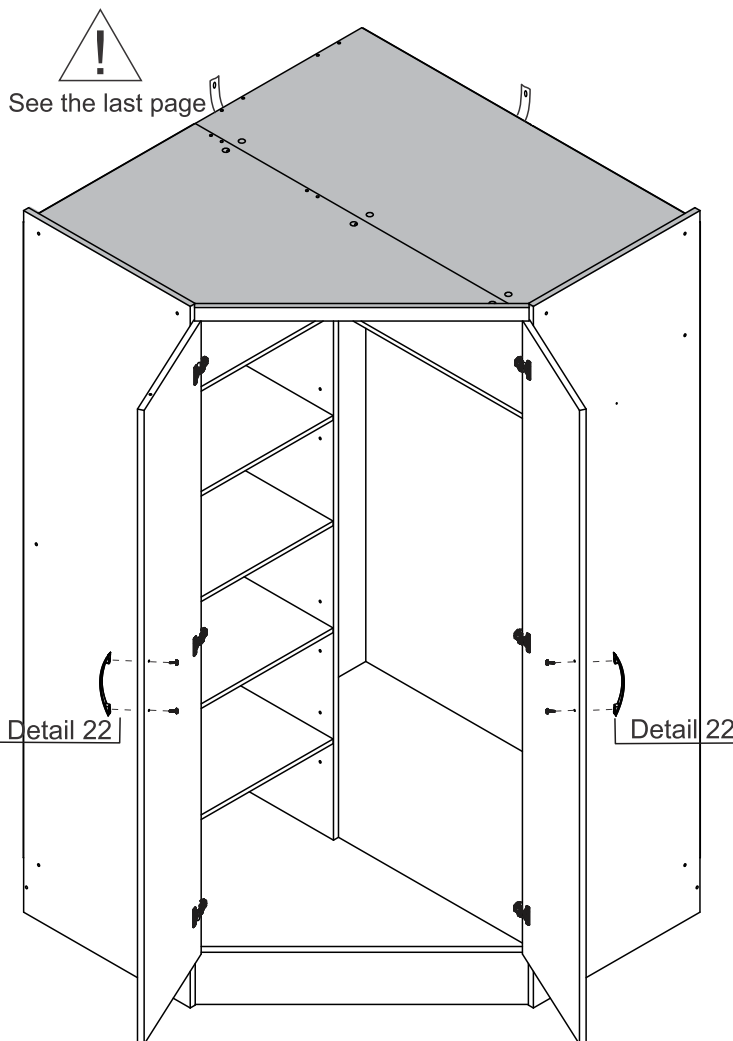
Detail 22

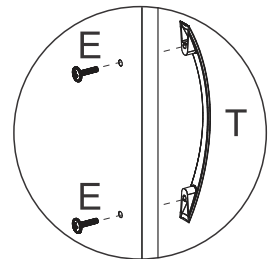

Height Adjustment

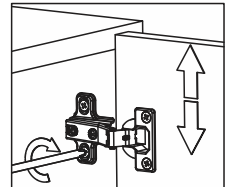

Internal Adjustment

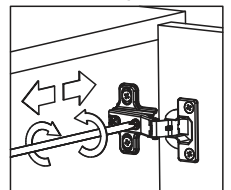

Depth Adjustment

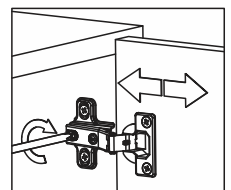
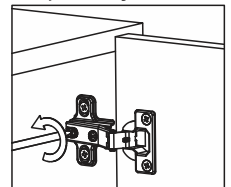

STEP 27

PARTS REQUIRED

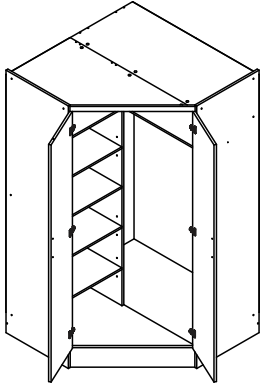

HARDWARE REQUIRED

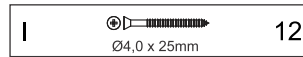

TOOLS REQUIRED

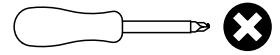

Detail 23

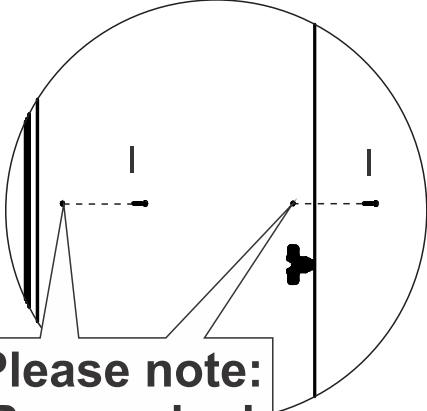

**Please note:
Pre-marked
Holes**

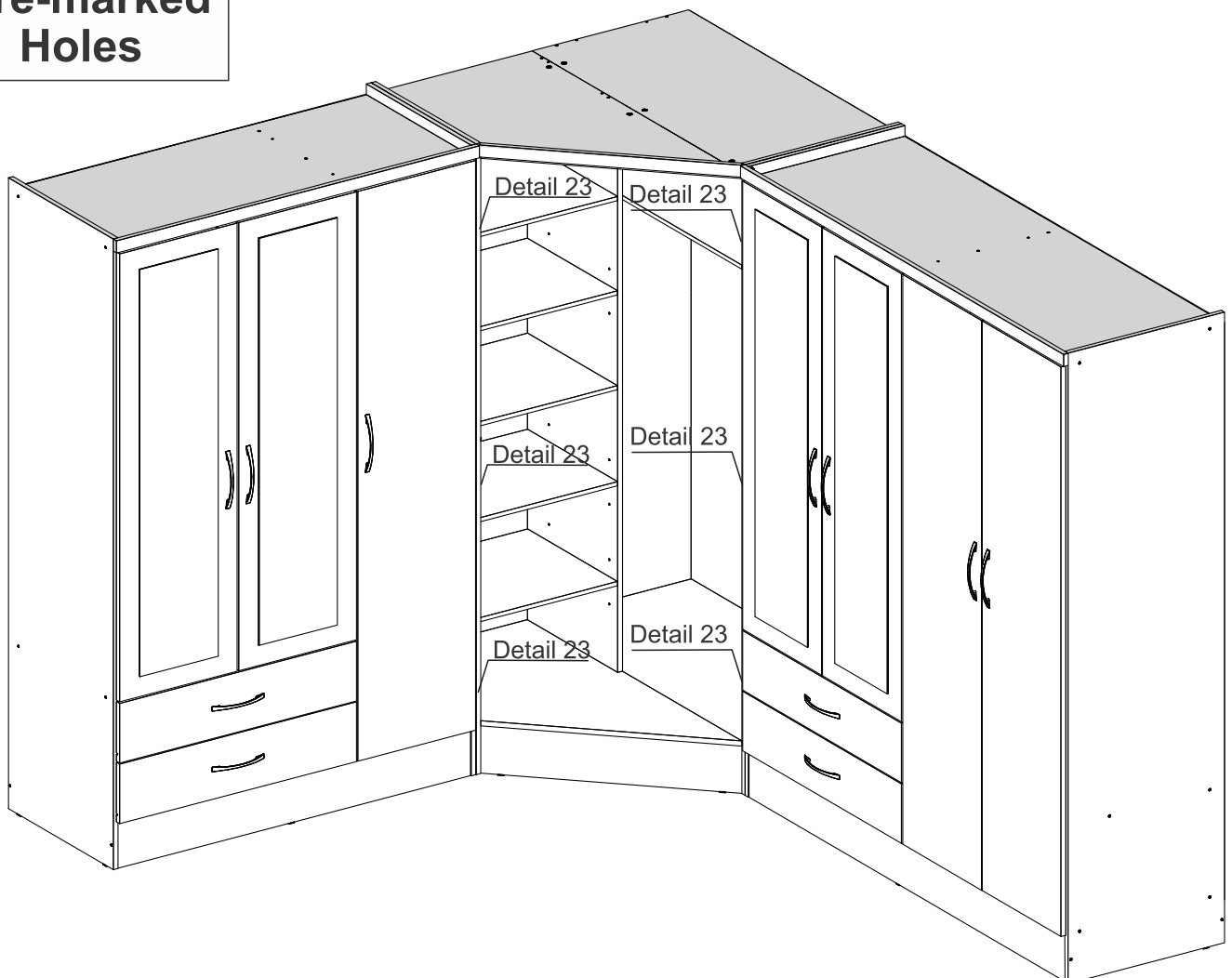

WARNING

Serious or fatal injuries can occur from furniture tipping over. To prevent the furniture from tipping over we recommend that it is permanently fixed to the wall.

Wall fixings are not supplied with this product as different wall materials require different types of fixing devices.

Please make sure you use fixings suitable for the walls in your home.

