

LEON 3 DOOR 2 DRAWER WARDROBE ASSEMBLY INSTRUCTIONS

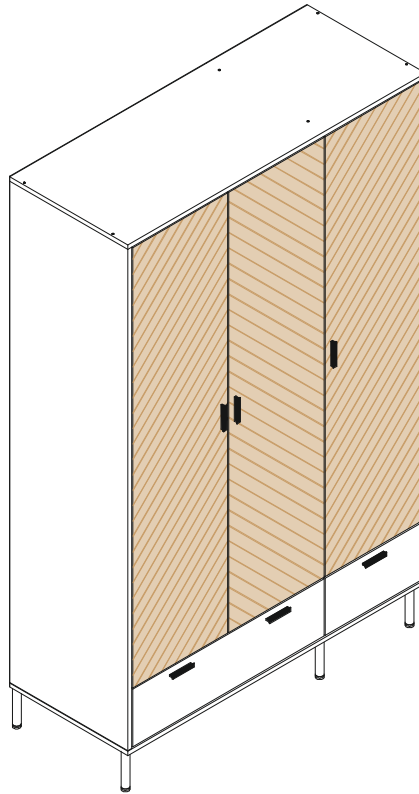

**FOR DOMESTIC USE ONLY
IMPORTANT**

PLEASE READ BEFORE YOU CONTINUE FURTHER

THE PRODUCT YOU HAVE PURCHASED WILL GIVE YOU MANY YEARS OF SERVICE IF YOU FOLLOW THE GUIDELINES FOR ITS SAFE ASSEMBLY AND PERIODIC MAINTENANCE AND CLEANING.

ASSEMBLE ON A SOFT CLEAN SURFACE.

DO NOT USE ANY TOOLS OTHER THAN THOSE SHOWN.

ANY SPANNERS OR ALLEN KEYS REQUIRED ARE INCLUDED WITH THE FITTING KIT.

DO NOT FOR ANY REASON USE A POWER TOOL TO ASSEMBLE THIS PRODUCT. ITS USE WILL INVALIDATE ANY CLAIM YOU MAY HAVE AND COULD MAKE THIS PRODUCT UNSAFE.

DEPENDING ON THE AMOUNT OF USE THIS PRODUCT RECEIVES, IT MAY BE NECESSARY TO TIGHTEN UP THE FIXINGS FROM TIME TO TIME. THIS IS COMPLETELY NORMAL FOR ANY FLAT PACK FURNITURE. DO NOT OVERTIGHTEN FIXINGS.

FOR CLEANING, YOU MAY USE A DAMP CLOTH (NOT WET). DO NOT USE POLISH, DETERGENT OR CHEMICAL CLEANERS.



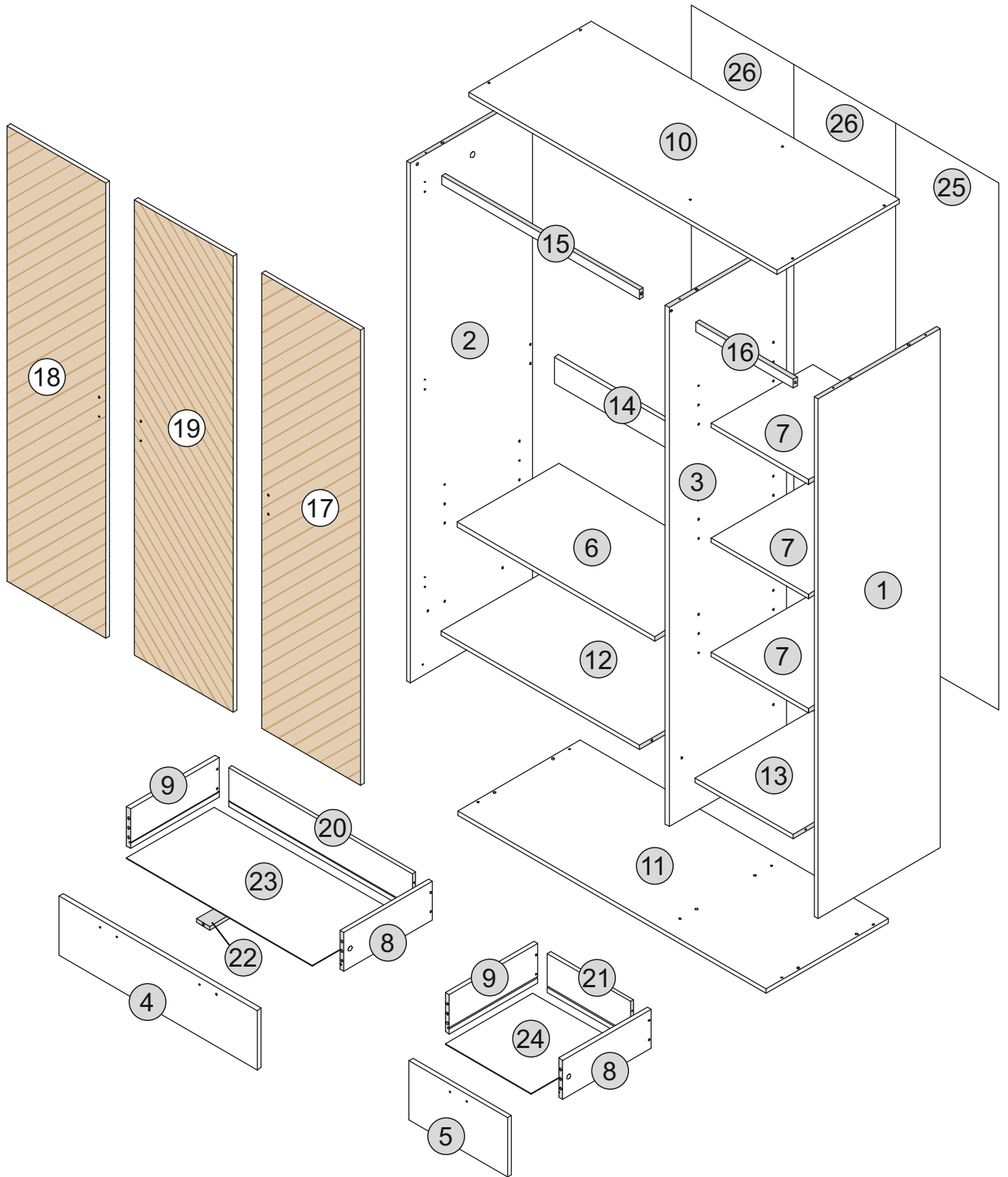















THIS SURFACE OF THIS ITEM IS NOT HEAT RESISTANT. ALWAYS USE A PLACE MAT UNDER HOT OR COLD ITEMS TO PREVENT MARKING.



PART LIST

Part Number	Part Code	Part Description	Quantity	Carton
1	S100-101-200-ZF1-01	Right Side Panel	1	1/3
2	S100-101-200-ZF1-02	Left Side Panel	1	1/3
3	S100-101-200-ZF1-03	Centre Panel	1	1/3
4	S100-101-200-ZF1-04	Large Drawer Front	1	2/3
5	S100-101-200-ZF1-05	Small Drawer Front	1	2/3
6	S100-101-200-ZF1-06	Large Adjustable Shelf Panel	1	2/3
7	S100-101-200-ZF1-07	Small Adjustable Shelf Panel	3	2/3
8	S100-101-200-ZF1-08	Right Drawer Side Panel	2	2/3
9	S100-101-200-ZF1-09	Left Drawer Side Panel	2	3/3
10	S100-101-200-ZF1-10	Top Panel	1	3/3
11	S100-101-200-ZF1-11	Bottom Panel	1	3/3
12	S100-101-200-ZF1-12	Large Shelf Panel	1	3/3
13	S100-101-200-ZF1-13	Small Shelf Panel	1	3/3
14	S100-101-200-ZF1-14	Back Support Panel	1	2/3
15	S100-101-200-ZF1-15	Large Top Support Panel	1	2/3
16	S100-101-200-ZF1-16	Small Top Support Panel	1	2/3
17	S100-101-200-ZF1-17	Right Door	1	2/3
18	S100-101-200-ZF1-18	Left Door	1	2/3
19	S100-101-200-ZF1-19	Centre Door	1	2/3
20	S100-101-200-ZF1-20	Large Drawer Back Panel	1	3/3
21	S100-101-200-ZF1-21	Small Drawer Back Panel	1	2/3
22	S100-101-200-ZF1-22	Drawer Support Panel	1	3/3
23	S100-101-200-ZF1-23	Large Drawer Base	1	1/3
24	S100-101-200-ZF1-24	Small Drawer Base	1	1/3
25	S100-101-200-ZF1-25	Large Back Panel	1	1/3
26	S100-101-200-ZF1-26	Small Back Panel	2	1/3

HARDWARE LIST

No	Part Name		Qty	Carton
A	M8x30mm Wooden Dowel		x34	1
B	Minifix Cam Bolt (8032t)		x11	1
C	Minifix Cam Nut (1512)		x10	1
D	M3.5x16mm Screw		x82	1
E	M4x45mm Screw		x12	1
F	M4x38mm Screw		x9	1
G	20mm Handle Screw		x12	1
H	Handle (64mm)		x6	1
I	14" Drawer Slide (VKT 0.9 - Black)		x2	1
J	Nail		x56	1
K	Iron Leg (150mm) - Black		x6	1
L	Shelf Support		x16	1
M	Wall Fixing (4x20mm=1pc)		x1	1
N	PVC L-Bracket		x2	1
O	End Hinges (M11)		x6	1
P	Hanging Rail (780mm)		x1	1
Q	Minifix Cam Nut (1510)		x1	1
R	Centre Hinges (M11-C)		x3	1

TIPS FOR FITTINGS CAM-LOCKS

WHEN FITTING CAM NUT, ENSURE STARTING POSITION IS CORRECT BEFORE YOU INSERT CONNECTING CAM BOLT TURN CLOCKWISE UNTIL SECURE

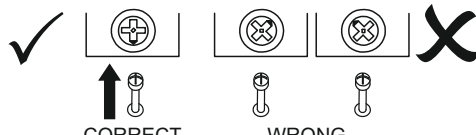

↑ CORRECT
 ↑ WRONG

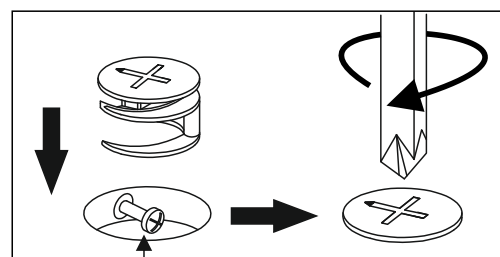

Cam bolt head needs to be in centre

CAMBOLT

Tighten until shoulder in flush with panel. Do not overtighten or undertighten (see example below)

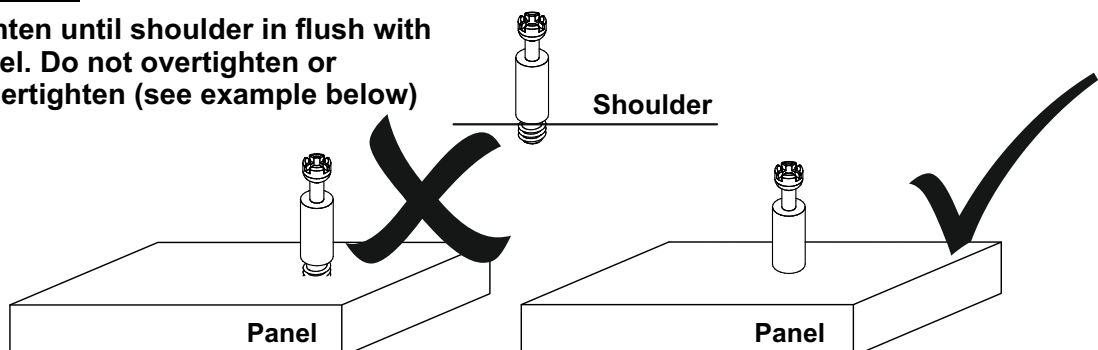

STEP 1

PARTS REQUIRED

1 - RIGHT SIDE PANEL x1

2 - LEFT SIDE PANEL x1

HARDWARE REQUIRED

D  04
3.5x16mm

I  01

TOOLS REQUIRED

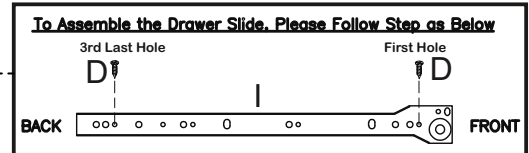
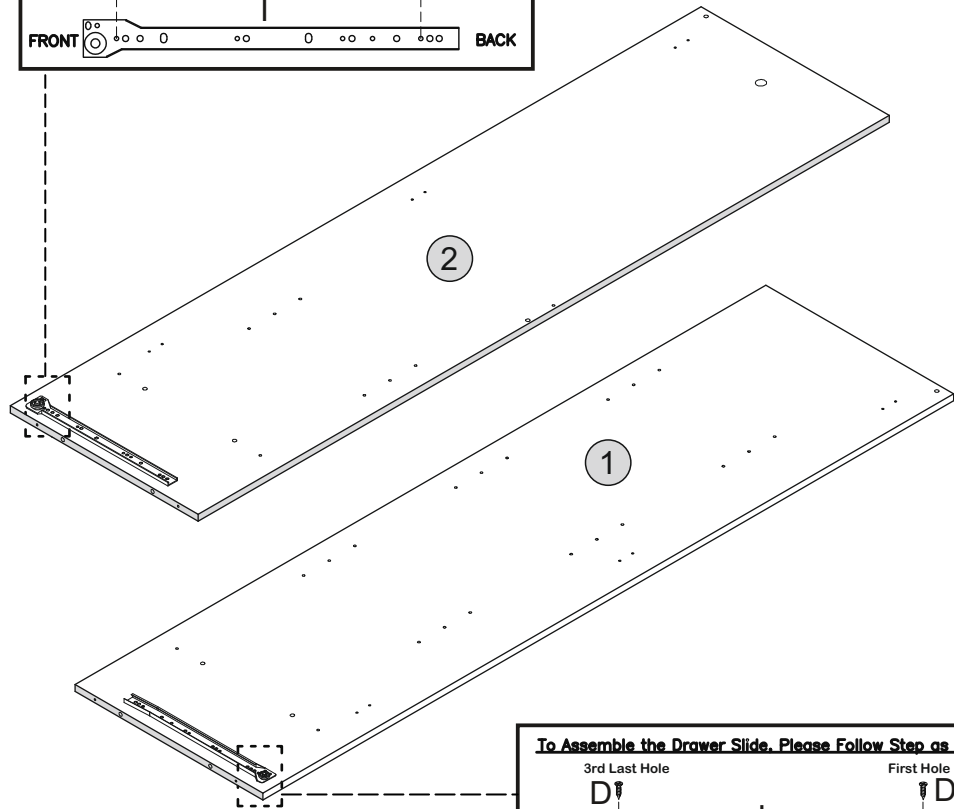
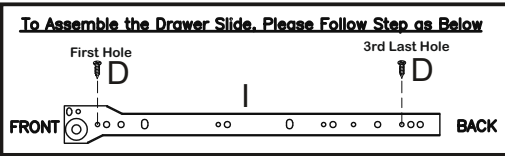
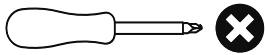

STEP 2

PARTS REQUIRED

1 - RIGHT SIDE PANEL x1

2 - LEFT SIDE PANEL x1

HARDWARE REQUIRED

A  08

B  05

L  08

TOOLS REQUIRED

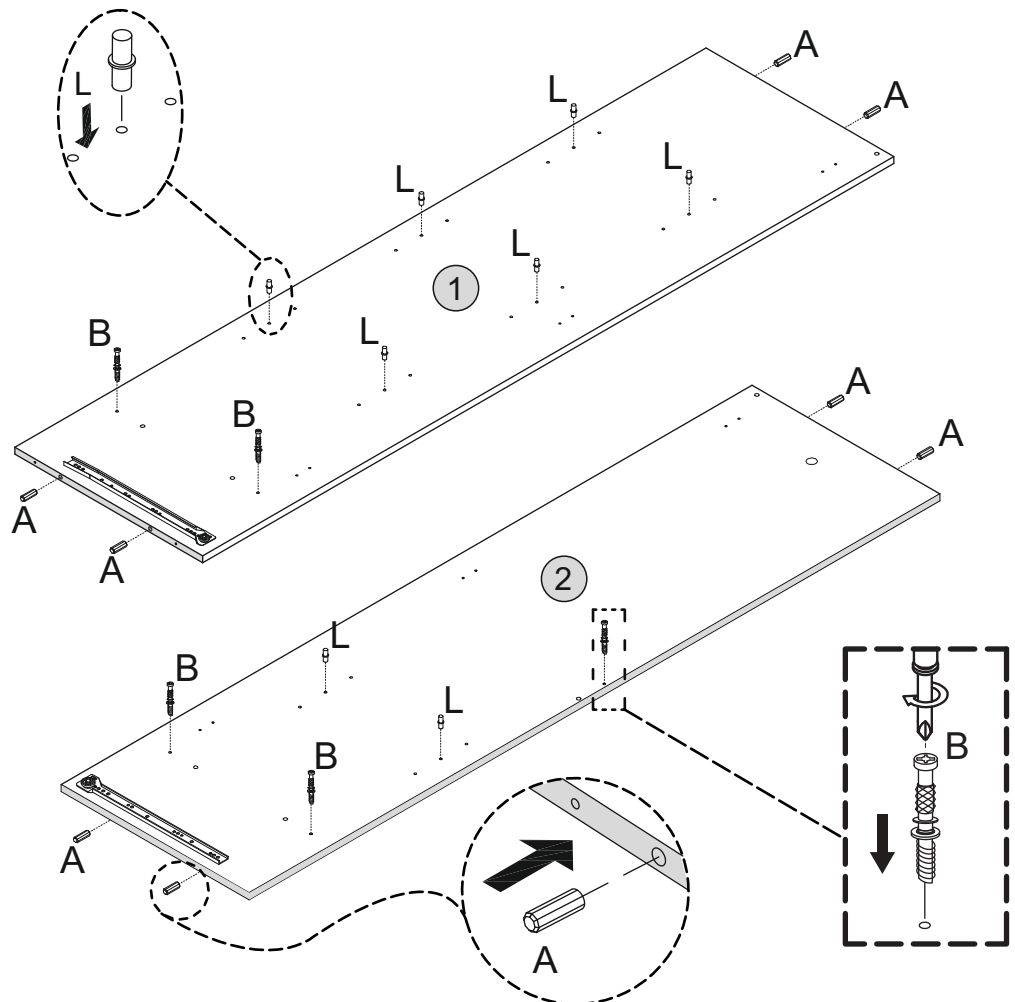
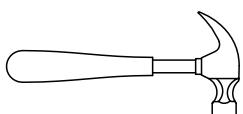
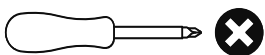

STEP 3

PARTS REQUIRED

3 - CENTRE PANEL x1

HARDWARE REQUIRED

D  04
3.5x16mm

I  01

TOOLS REQUIRED

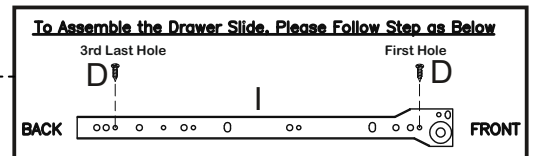
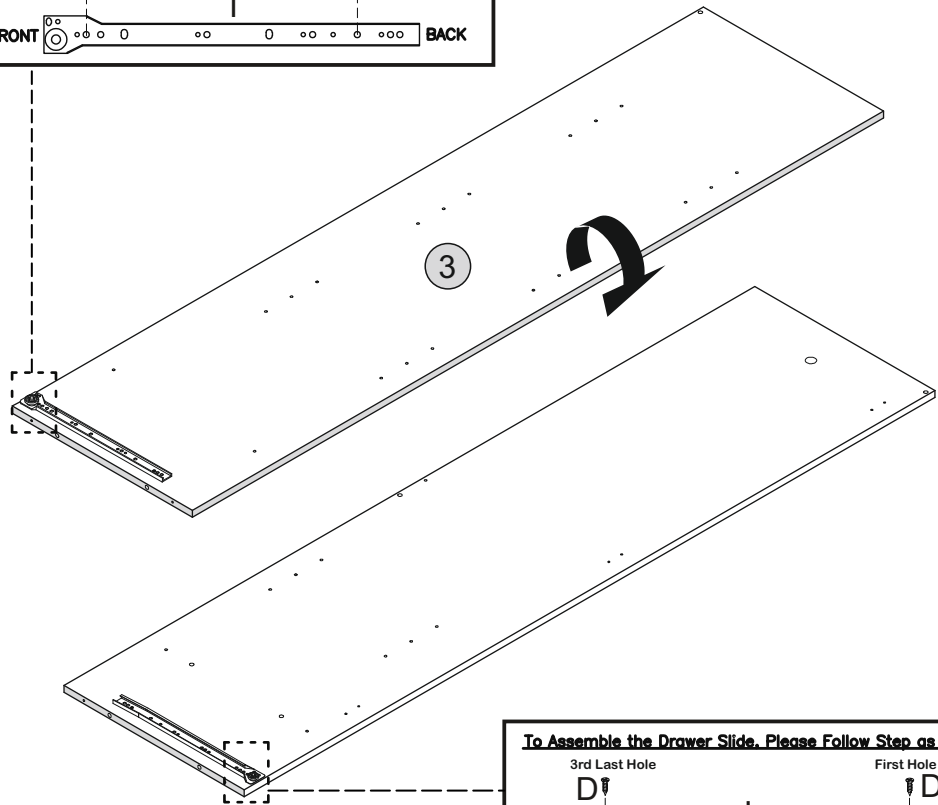
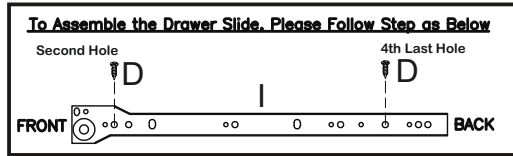
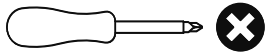



STEP 4

PARTS REQUIRED

3 - CENTRE PANEL x1

HARDWARE REQUIRED

A  04

B  01

L  08

TOOLS REQUIRED

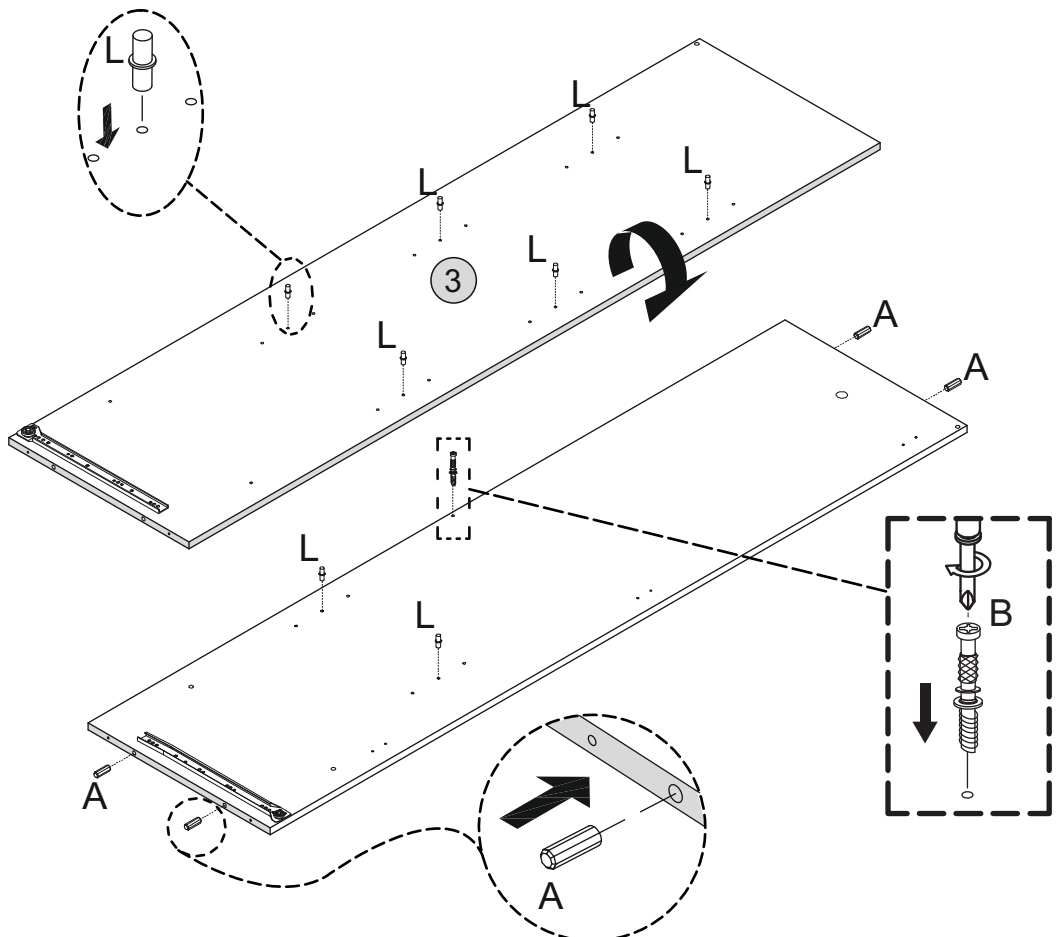
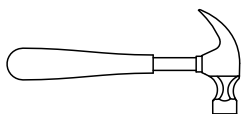
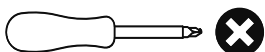



STEP 5

PARTS REQUIRED

- 12 - LARGE SHELF PANEL x1
- 13 - SMALL SHELF PANEL x1
- 14 - BACK SUPPORT PANEL x1

HARDWARE REQUIRED

- A  10
- C  06

TOOLS REQUIRED

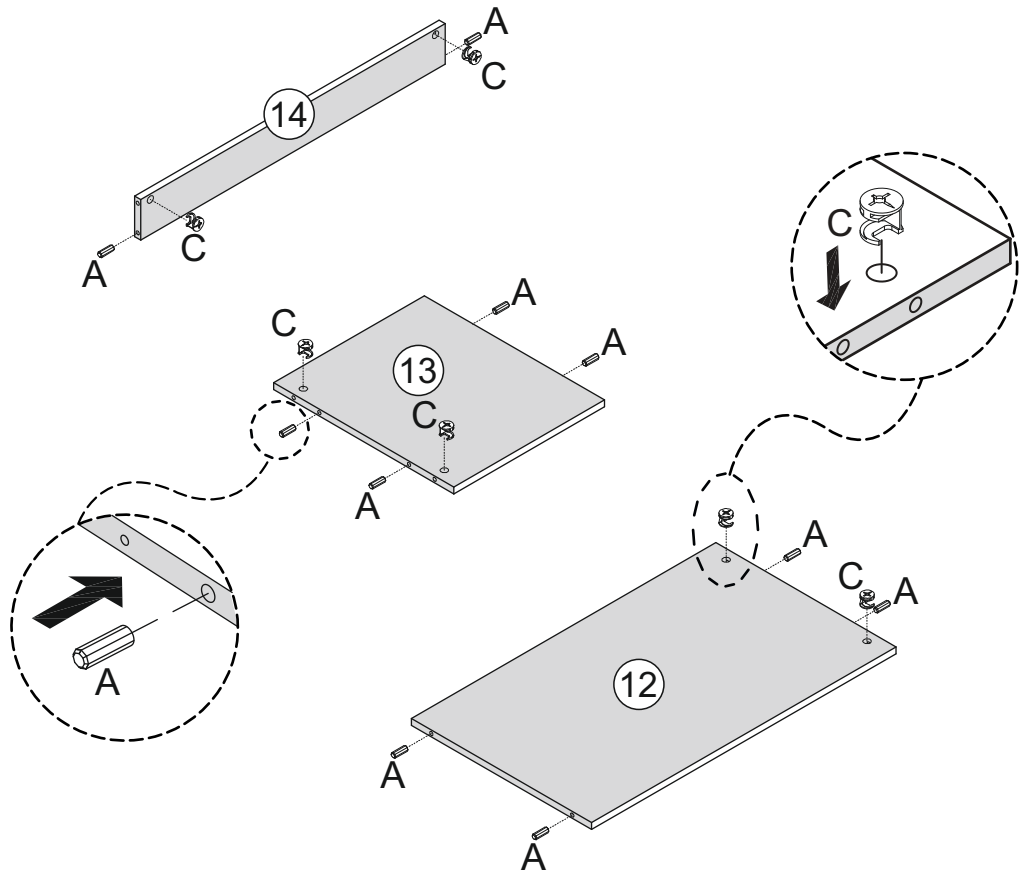
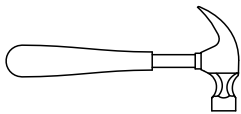



STEP 6

PARTS REQUIRED

- 10 - TOP PANEL x1
- 15 - LARGE TOP SUPPORT PANEL X1
- 16 - SMALL TOP SUPPORT PANEL X1

HARDWARE REQUIRED

- A  04
- D  3.5x16mm 02
- N  02

TOOLS REQUIRED

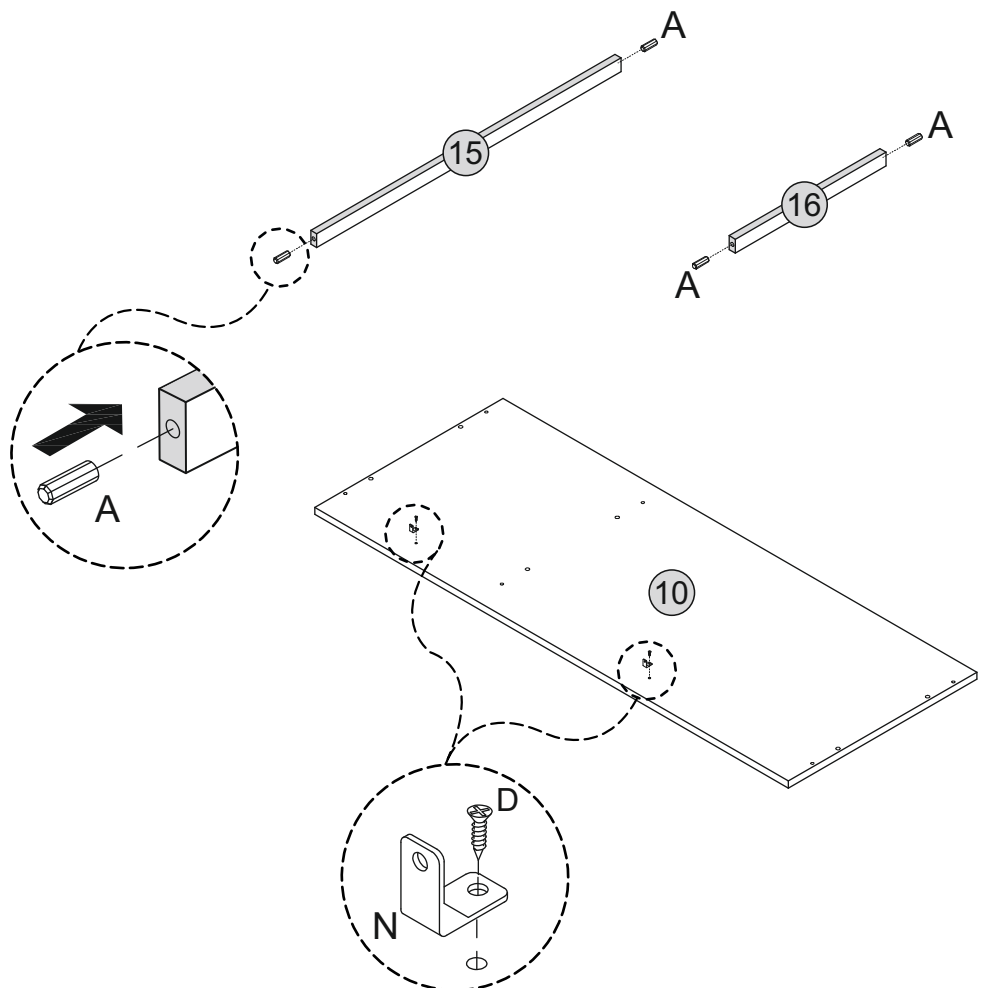
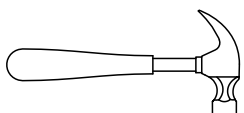
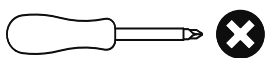



STEP 7

PARTS REQUIRED

17 - RIGHT DOOR	x1
18 - LEFT DOOR	x1
19 - CENTRE DOOR	x1

HARDWARE REQUIRED

D		18
O		06
R		03

TOOLS REQUIRED

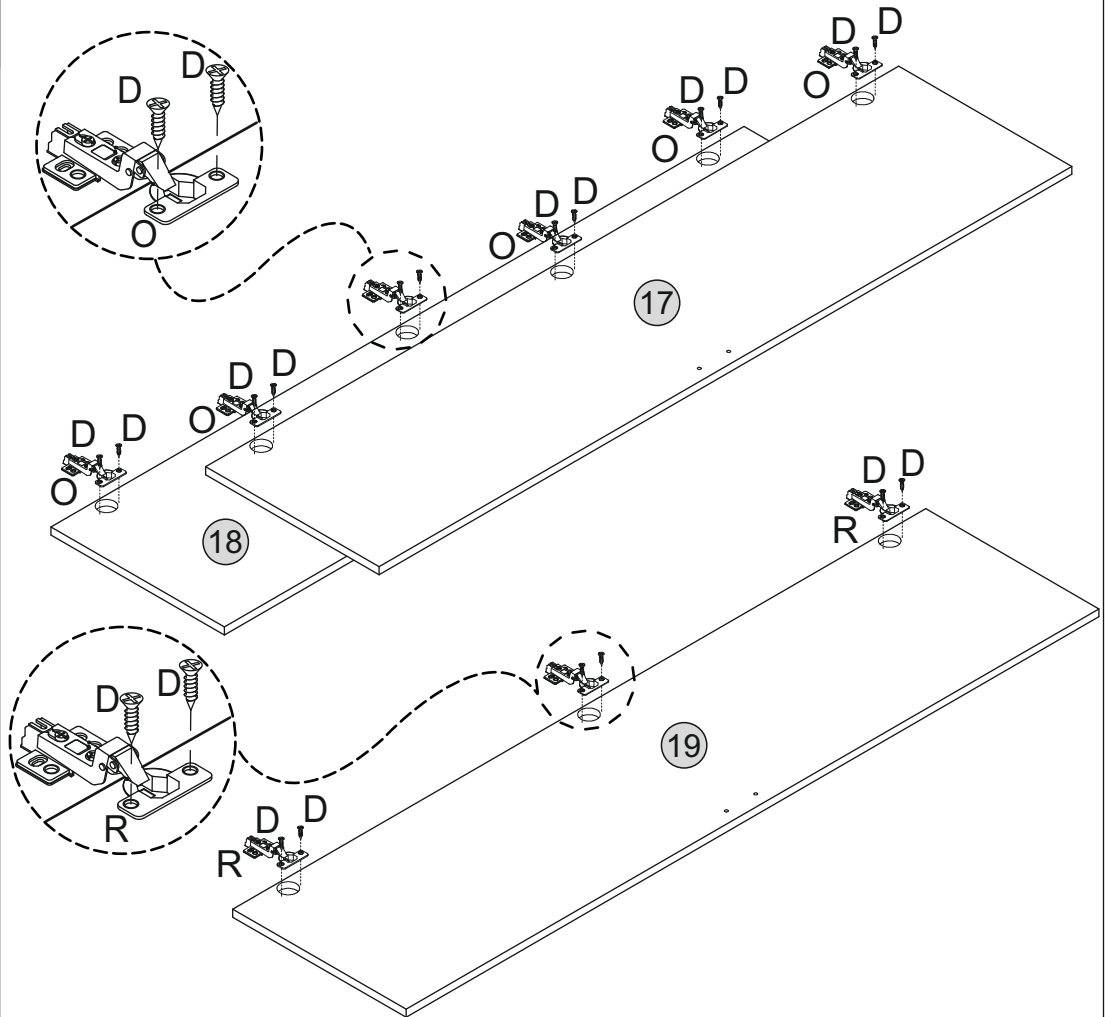
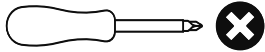

STEP 8

PARTS REQUIRED

1 - RIGHT SIDE PANEL	x1
7 - SMALL ADJUSTABLE SHELF	x2
13 - SMALL SHELF PANEL	x1
16 - SMALL SUPPORT PANEL	x1

HARDWARE REQUIRED

TOOLS REQUIRED

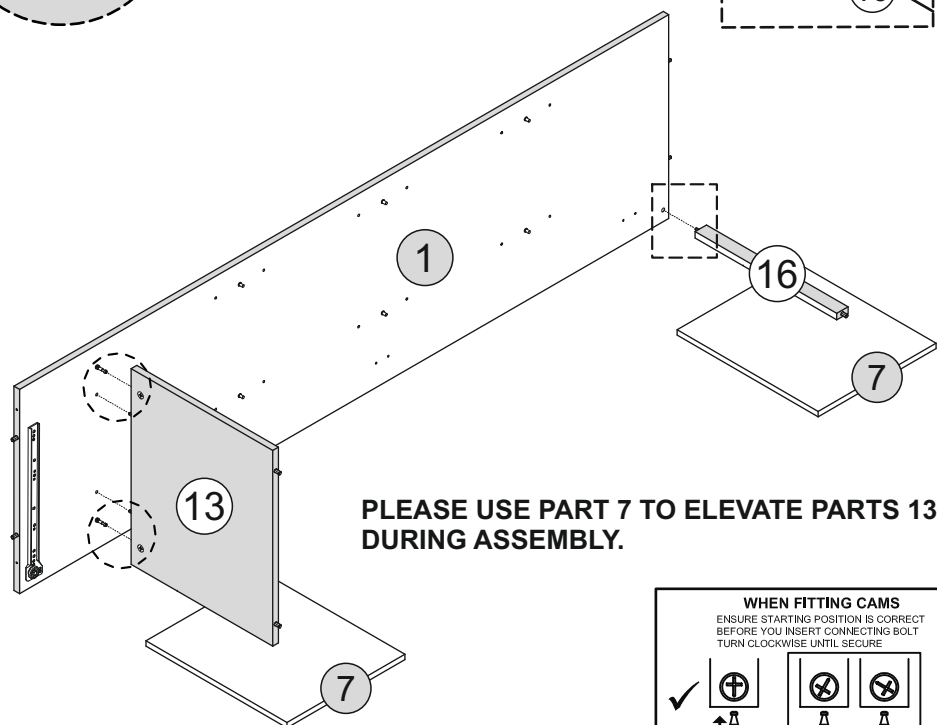
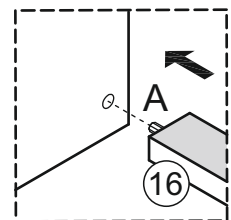
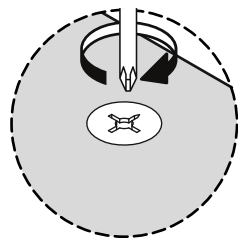
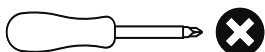

PLEASE USE PART 7 TO ELEVATE PARTS 13 & 16, DURING ASSEMBLY.

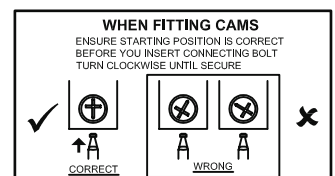

STEP 9

PARTS REQUIRED

3 - CENTRE PANEL x1

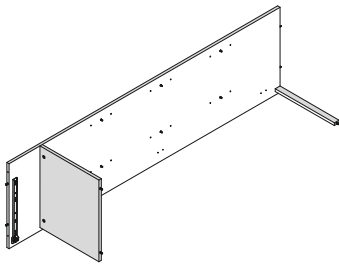

HARDWARE REQUIRED

TOOLS REQUIRED

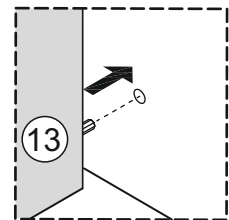
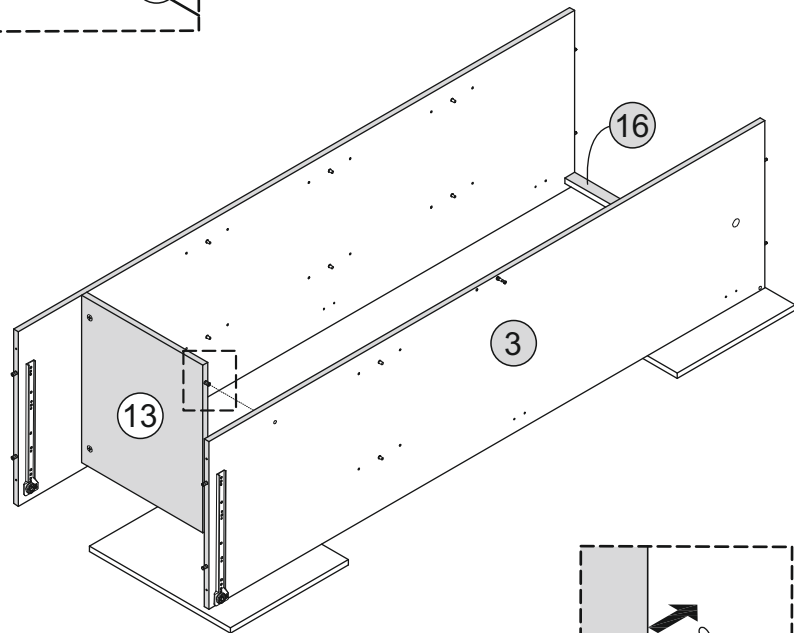
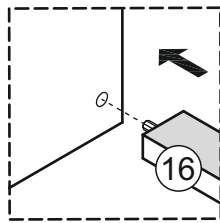
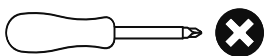

STEP 10

PARTS REQUIRED

12 - LARGE SHELF PANEL x1

15 - LARGE TOP SUPPORT PANEL x1

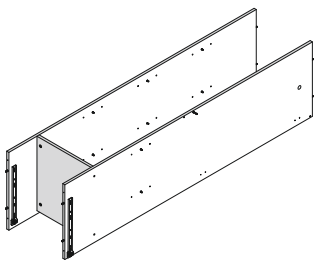

HARDWARE REQUIRED

TOOLS REQUIRED

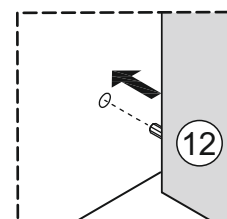
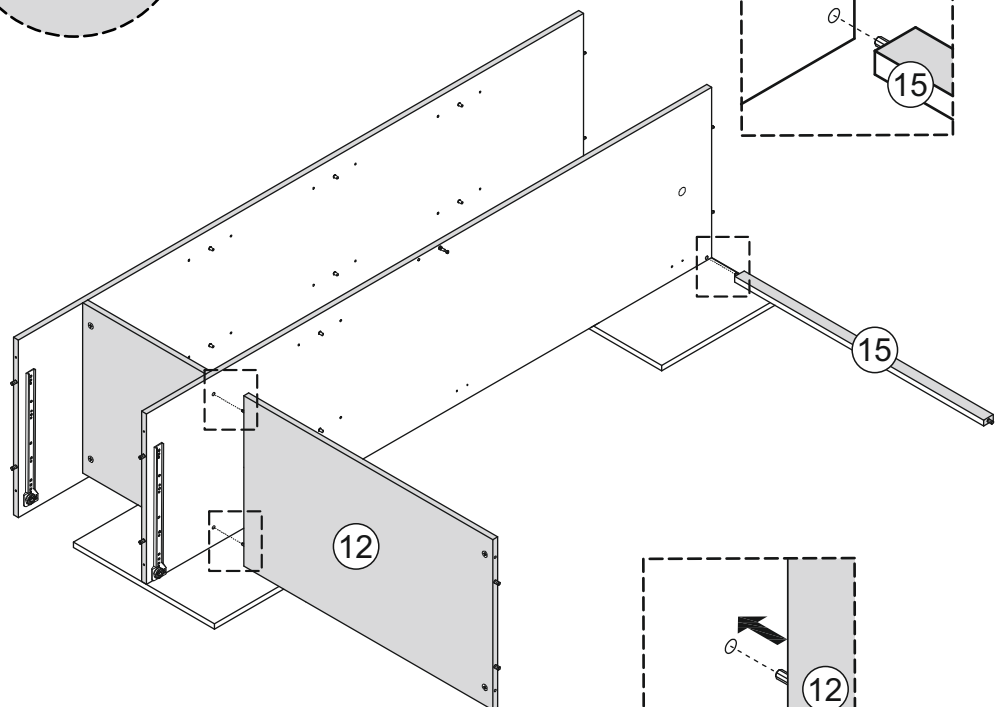
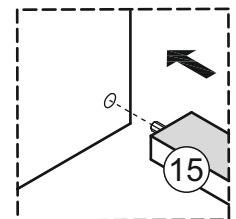
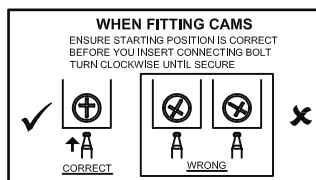
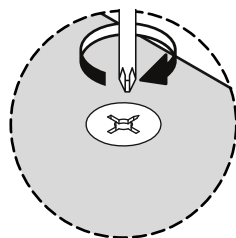
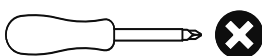

STEP 11

PARTS REQUIRED

2 - LEFT SIDE PANEL x1

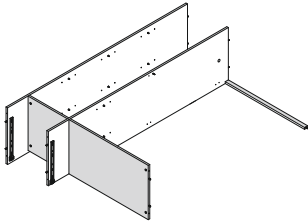

HARDWARE REQUIRED

TOOLS REQUIRED

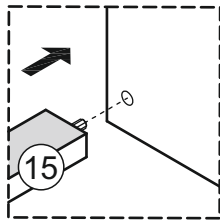
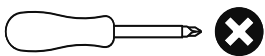

15

15

2

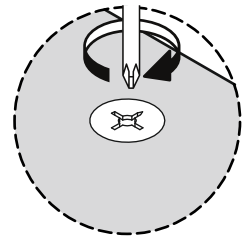
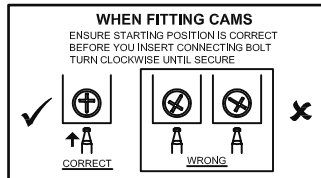
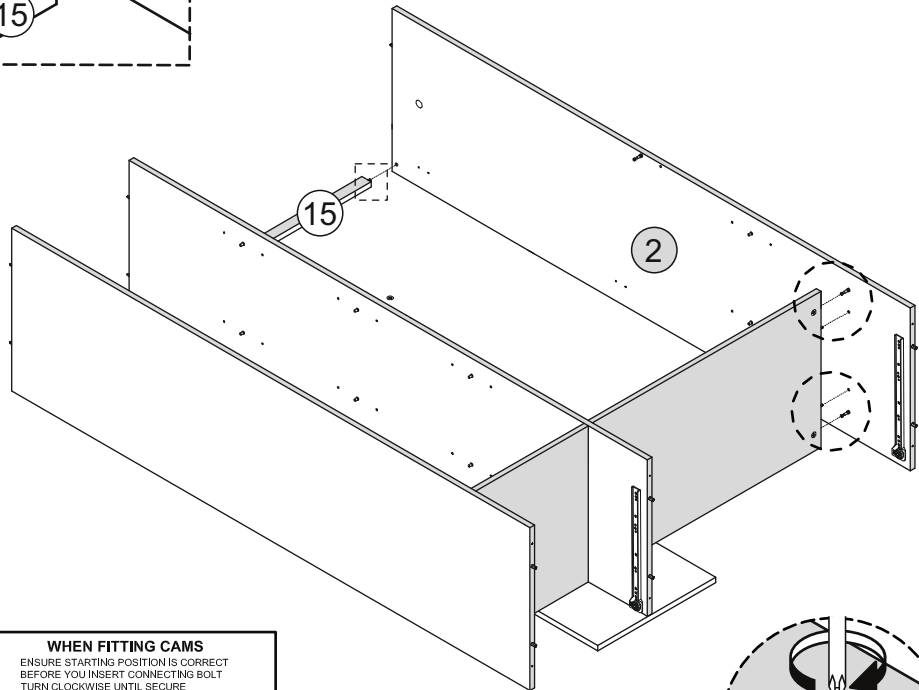

STEP 12

PARTS REQUIRED

14 - BACK SUPPORT PANEL x1

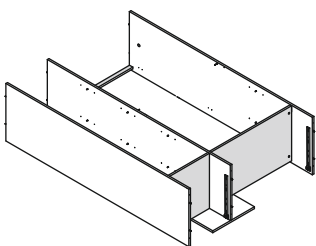

HARDWARE REQUIRED

P 01

TOOLS REQUIRED

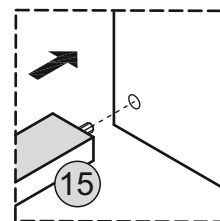
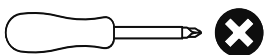

15

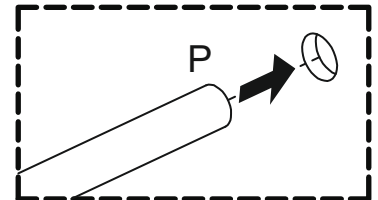

P

14

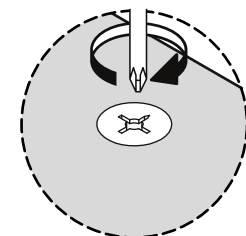
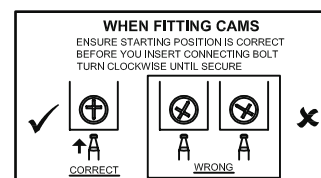
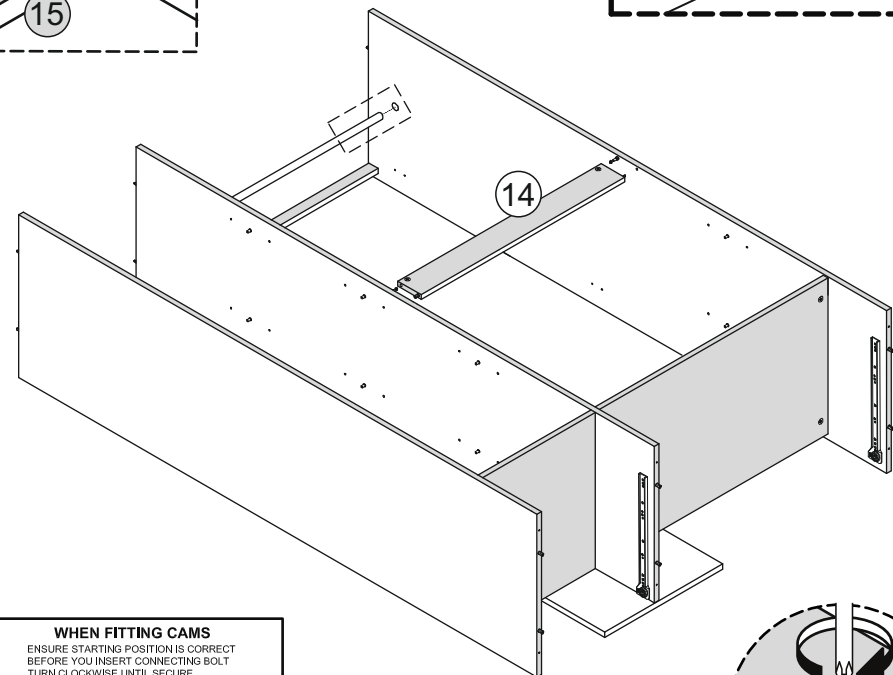

STEP 13

PARTS REQUIRED

10 - TOP PANEL x1

11 - BOTTOM PANEL x1

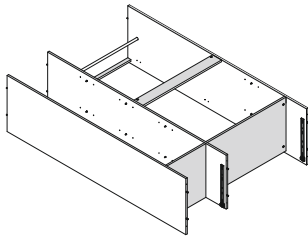

HARDWARE REQUIRED

E  4x45mm 12

TOOLS REQUIRED

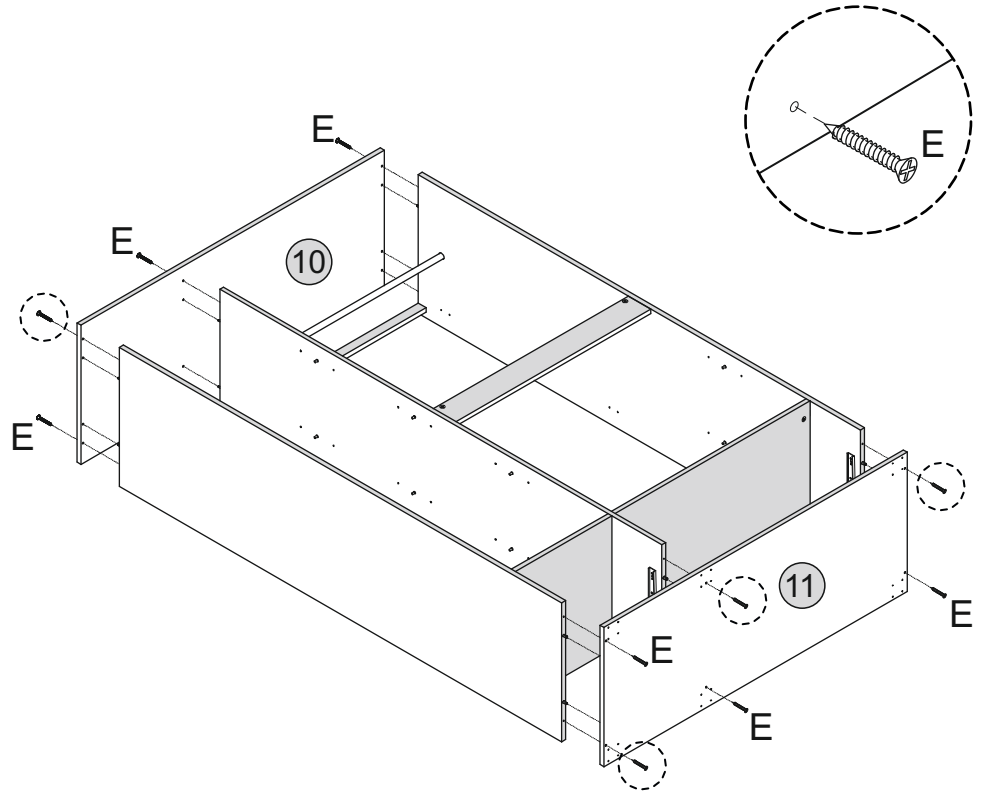
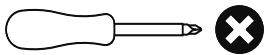

STEP 14

PARTS REQUIRED

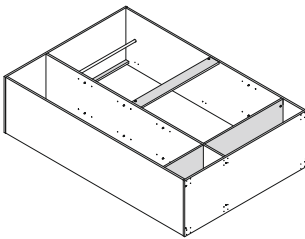

HARDWARE REQUIRED

D  3.5x16mm 26

K  06

TOOLS REQUIRED

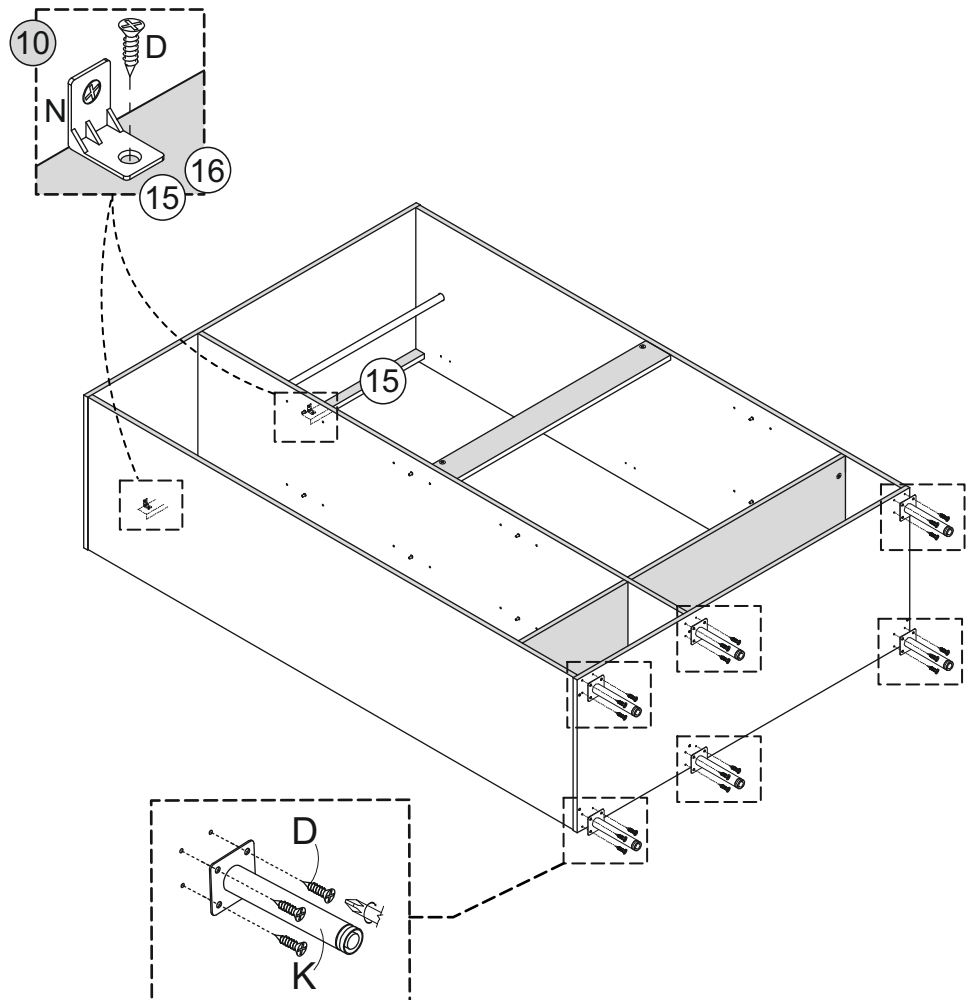
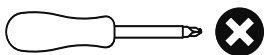

STEP 15

PARTS REQUIRED

25 - LARGE BACK PANEL x1

26 - SMALL BACK PANEL x2

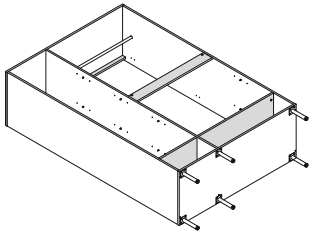

HARDWARE REQUIRED

D  02
3.5x16mm

J  56

TOOLS REQUIRED

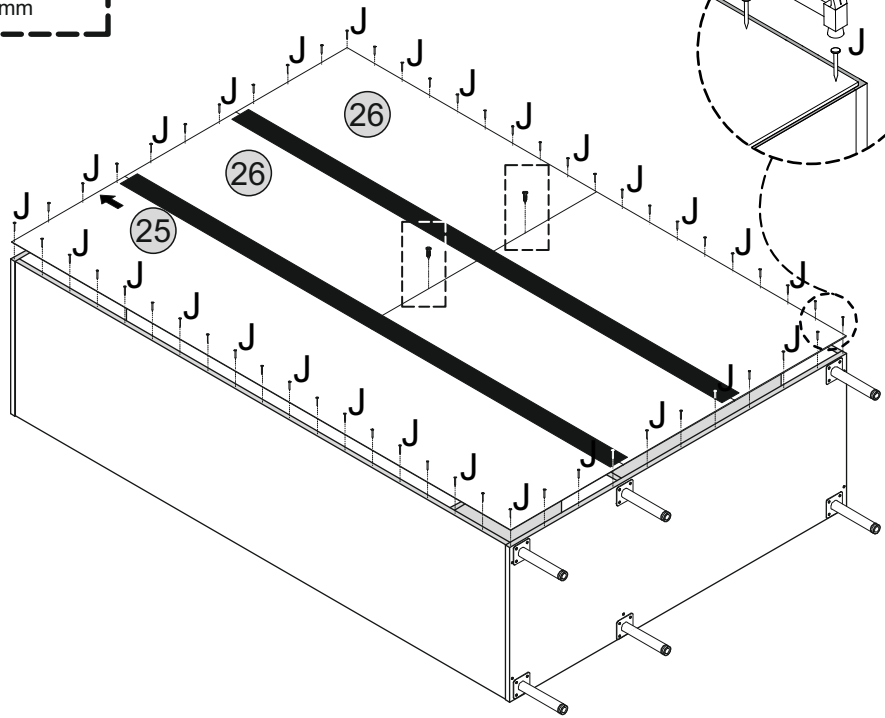
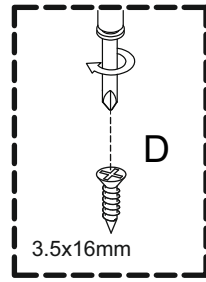
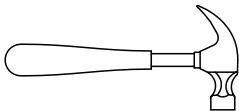
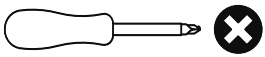

STEP 16

PARTS REQUIRED

4 - LARGE DRAWER FRONT x1

5 - SMALL DRAWER FRONT x1

8 - RIGHT DRAWER SIDE x2

9 - LEFT DRAWER SIDE x2

22 - DRAWER SUPPORT x1

HARDWARE REQUIRED

A  08

B  05

C  04

Q  01

TOOLS REQUIRED

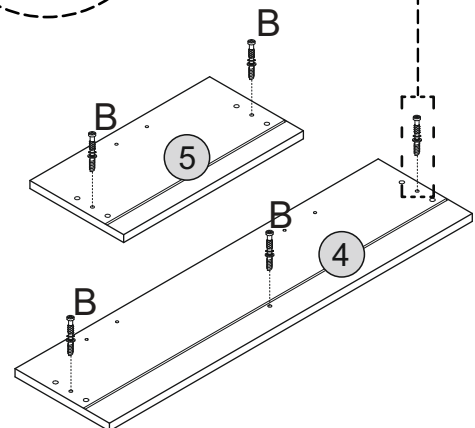
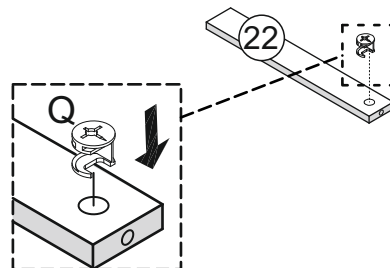
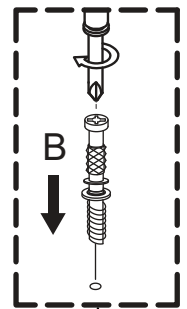
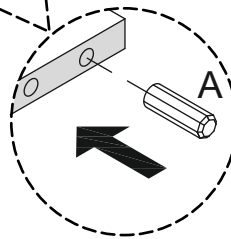
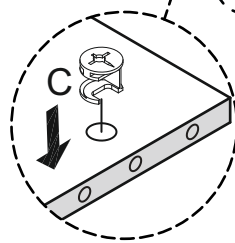
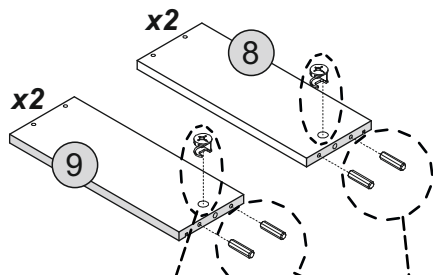
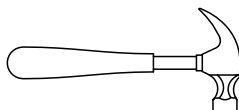
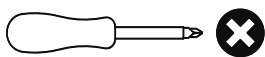

STEP 17

PARTS REQUIRED

- 8 - RIGHT DRAWER SID x1
- 9 - LEFT DRAWER SID x1
- 21 - SMALL DRAWER BACK x1
- 24 - SMALL DRAWER BASE x1

HARDWARE REQUIRED

- F  04

TOOLS REQUIRED

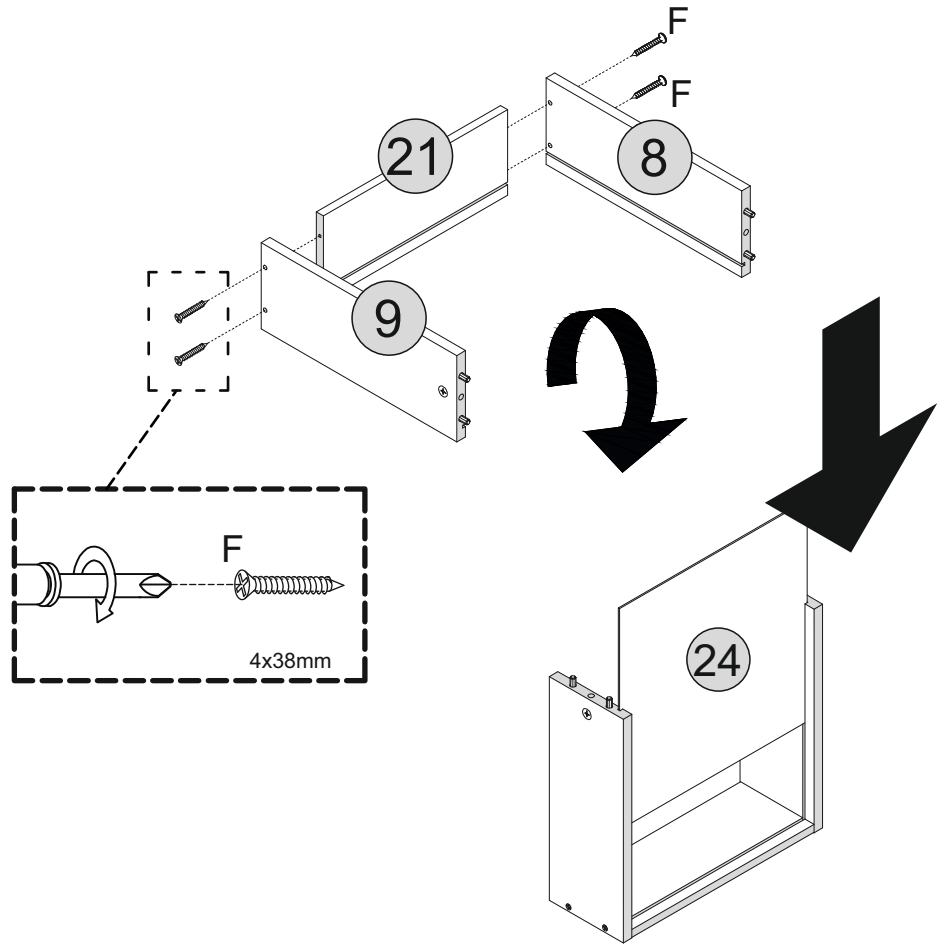
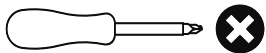

STEP 18

PARTS REQUIRED

- 8 - RIGHT DRAWER SIDE X1
- 9 - LEFT DRAWER SIDE X1
- 20 - LARGE DRAWER BACK X1
- 22 - DRAWER SUPPORT X1
- 23 - LARGE DRAWER BASE X1

HARDWARE REQUIRED

- F  05

TOOLS REQUIRED

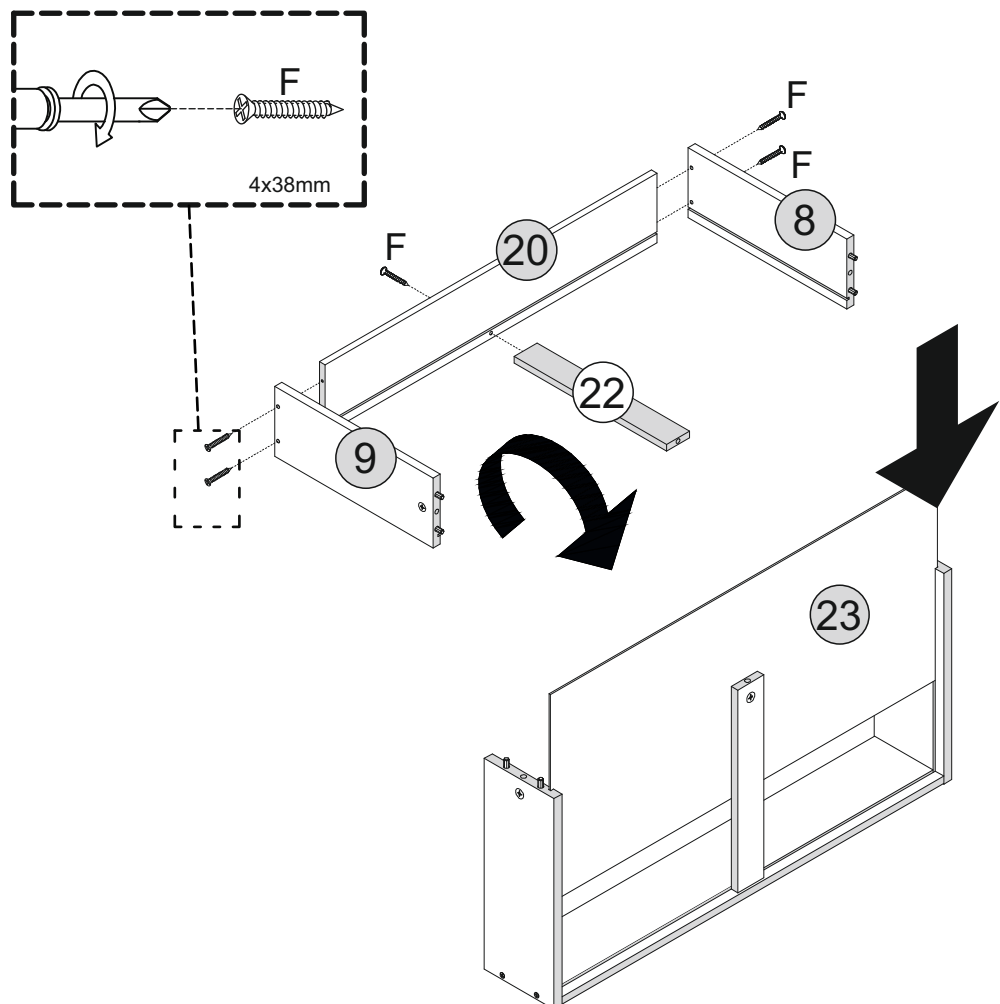
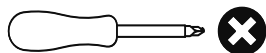

STEP 19

PARTS REQUIRED

4 - LARGE DRAWER FRONT x1

5 - SMALL DRAWER FRONT x1

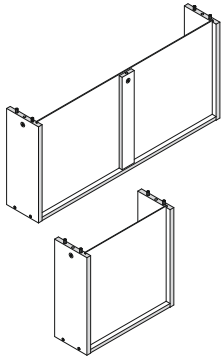

HARDWARE REQUIRED

TOOLS REQUIRED

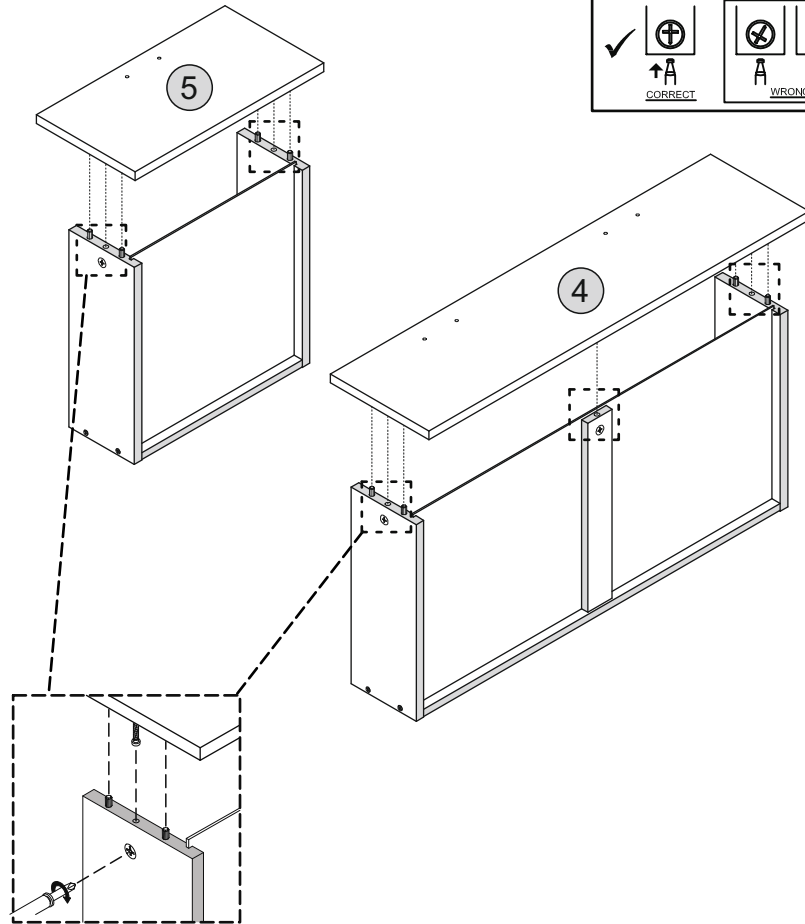
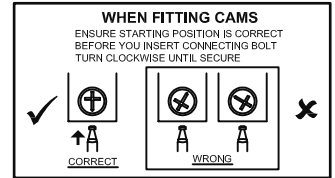
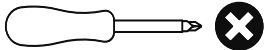

STEP 20

PARTS REQUIRED

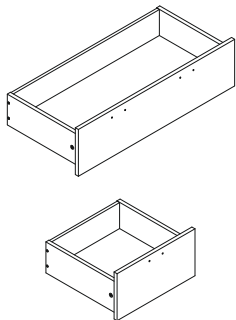

HARDWARE REQUIRED

G  06

H  03

TOOLS REQUIRED

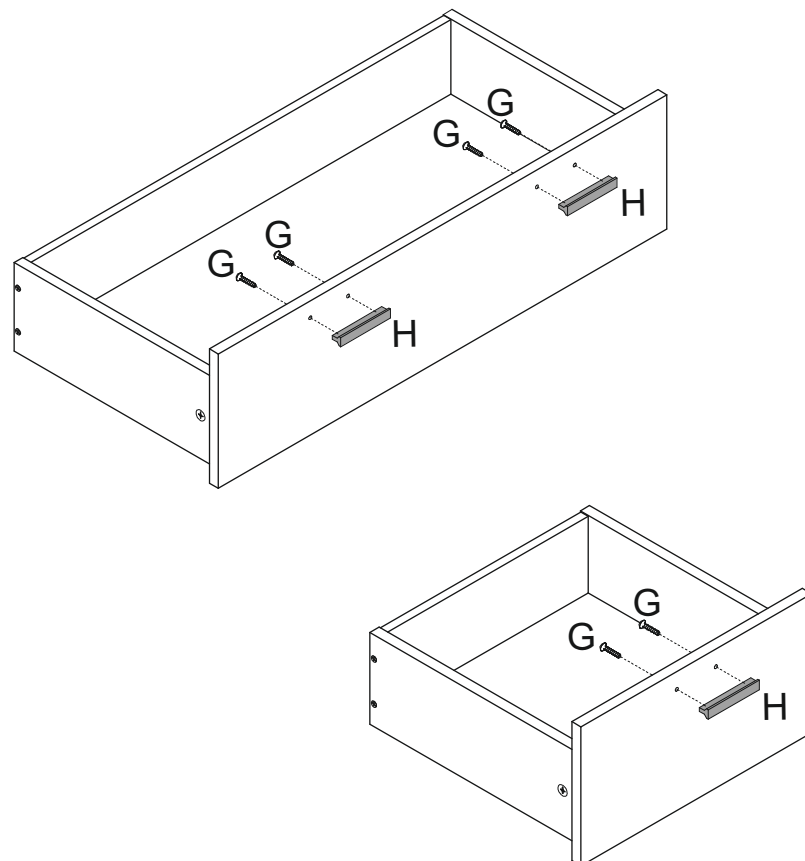
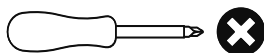

STEP 21

PARTS REQUIRED

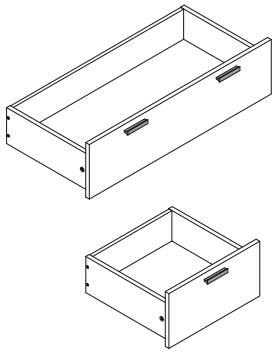

HARDWARE REQUIRED

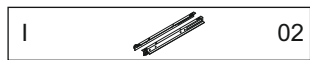
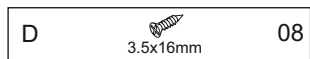

TOOLS REQUIRED

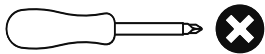

Turn Back 

FRONT

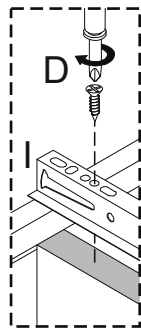

BACK

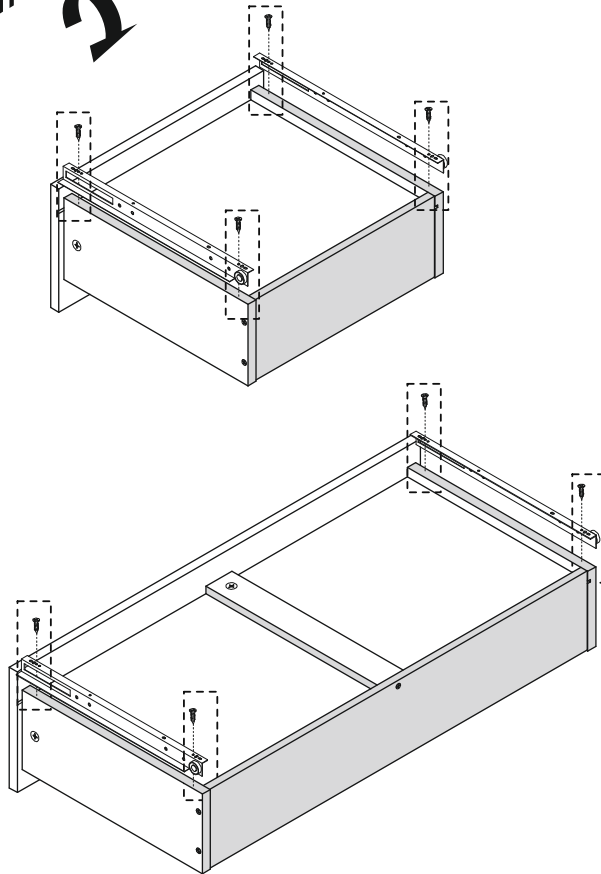
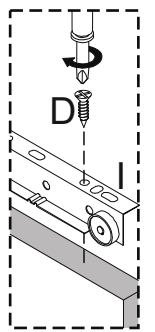

STEP 22

PARTS REQUIRED

6 - LARGE ADJUSTABLE SHELF PANEL x1

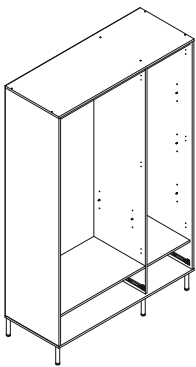

HARDWARE REQUIRED

TOOLS REQUIRED

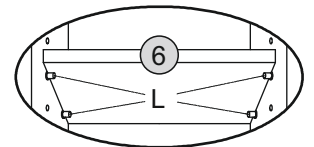
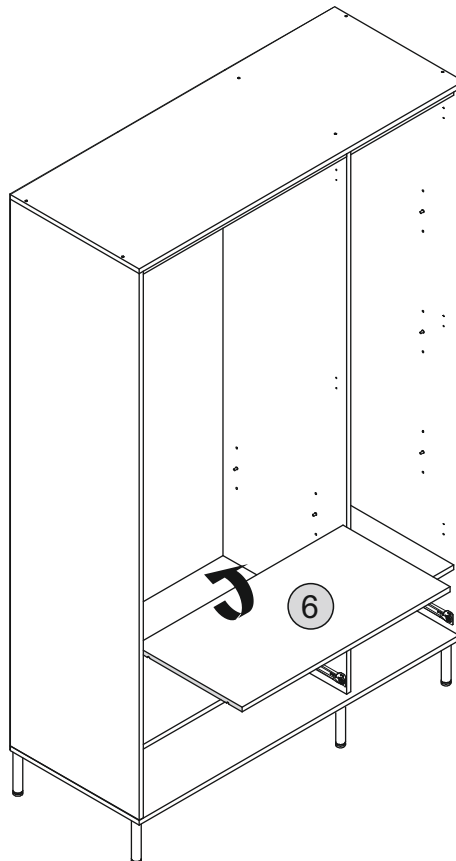

STEP 23

PARTS REQUIRED

7 - SMALL ADJUSTABLE SHELF PANEL x3

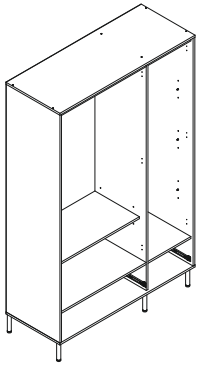

HARDWARE REQUIRED

TOOLS REQUIRED

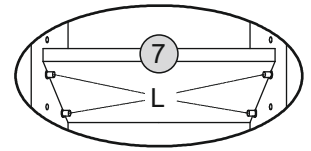
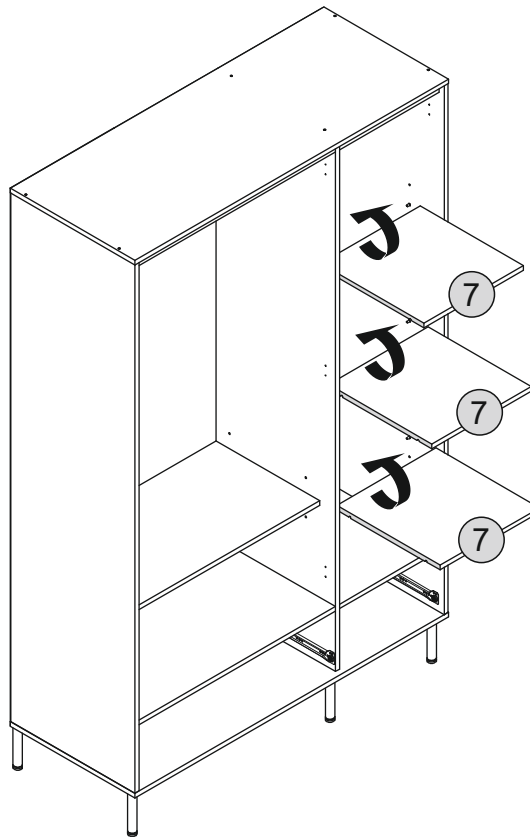

STEP 24

PARTS REQUIRED

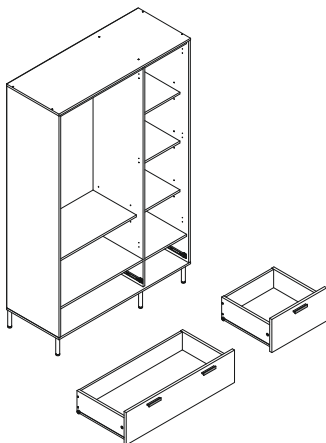

HARDWARE REQUIRED

TOOLS REQUIRED

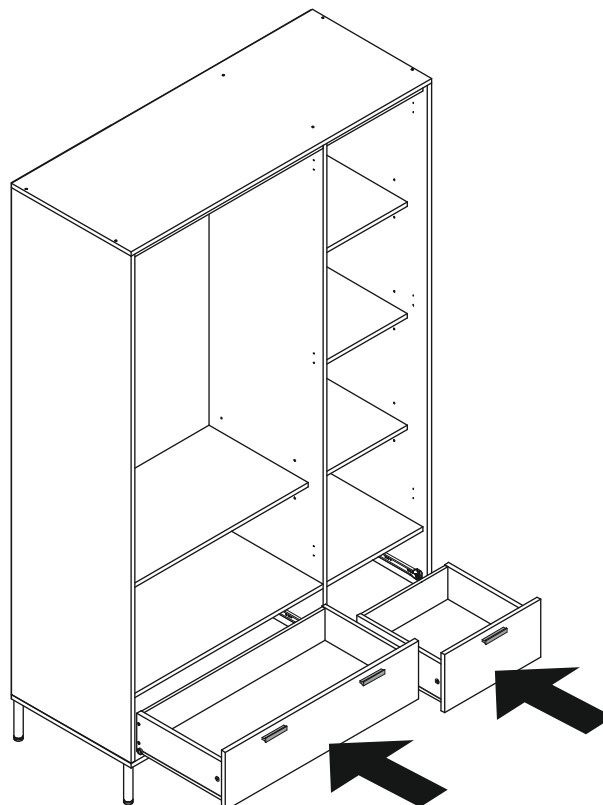

STEP 25

PARTS REQUIRED

17 - RIGHT DOOR x1

18 - LEFT DOOR x1

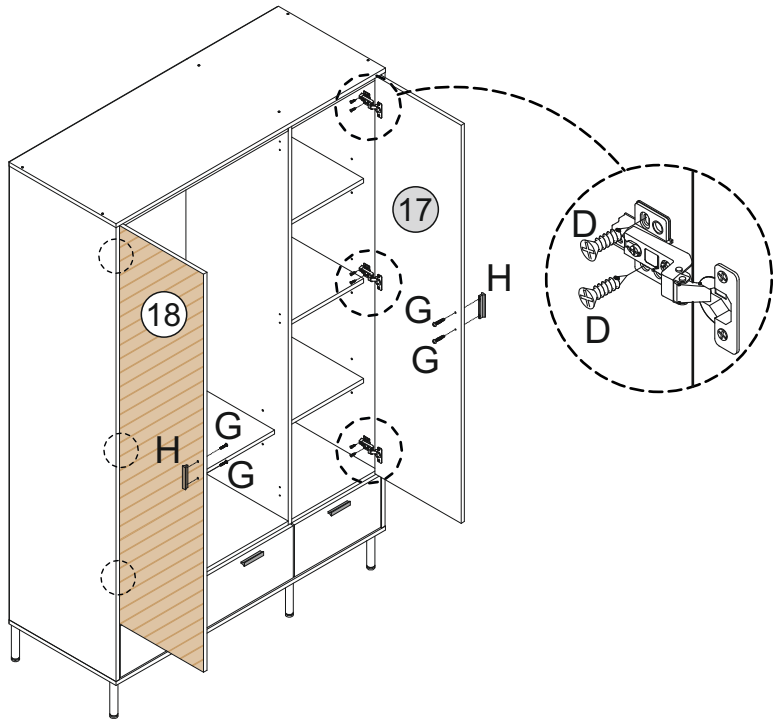
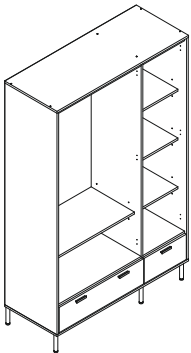

HARDWARE REQUIRED

D  12
3.5x16mm

G  04

H  02

TOOLS REQUIRED

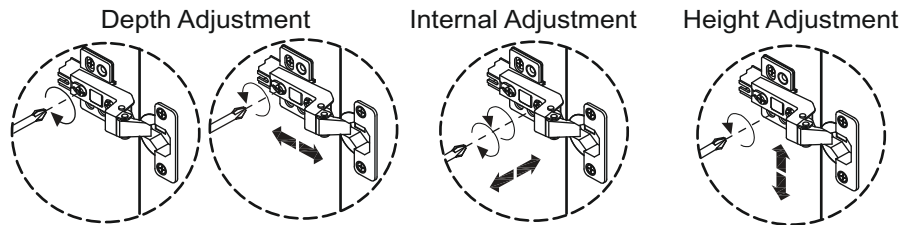
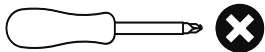

STEP 26

PARTS REQUIRED

19 - CENTRE DOOR x1

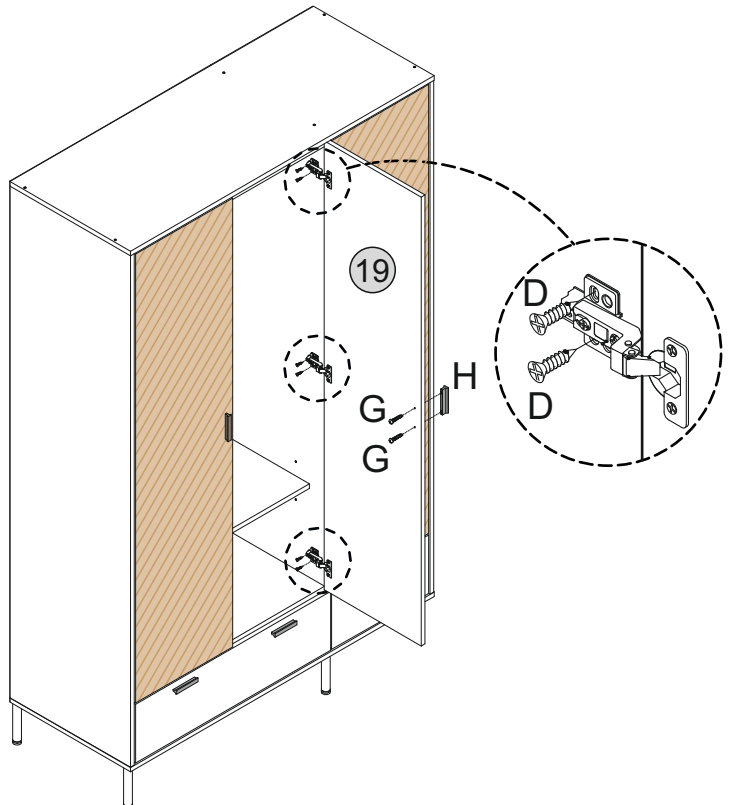
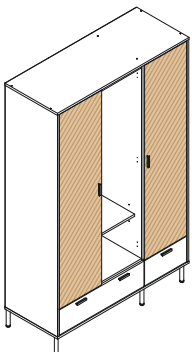

HARDWARE REQUIRED

D  06
3.5x16mm

G  02

H  01

TOOLS REQUIRED

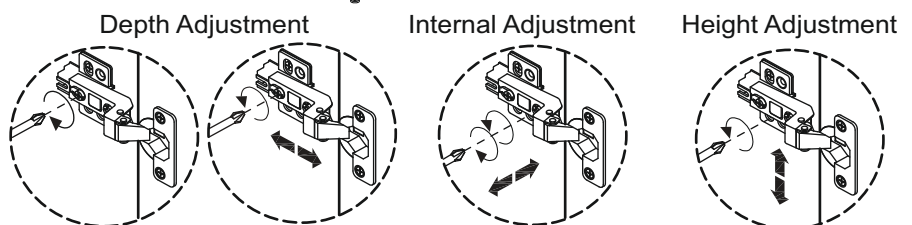
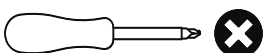

STEP 27

PARTS REQUIRED

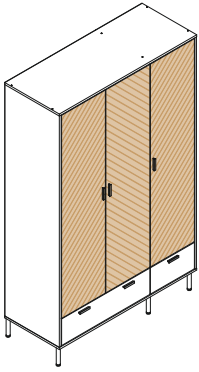

HARDWARE REQUIRED

M



01

TOOLS REQUIRED

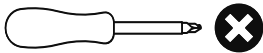

WARNING

Serious or fatal injuries can occur from furniture tipping over. To prevent the furniture from tipping over we recommend that it is permanently fixed to the wall.

Wall fixings are not supplied with this product as different wall materials require different types of fixing devices. Please make sure you use fixings suitable for the walls in your home.

