

# CLEVELAND 3 DOOR WARDROBE ASSEMBLY INSTRUCTIONS WHITE/GREY METAL EFFECT

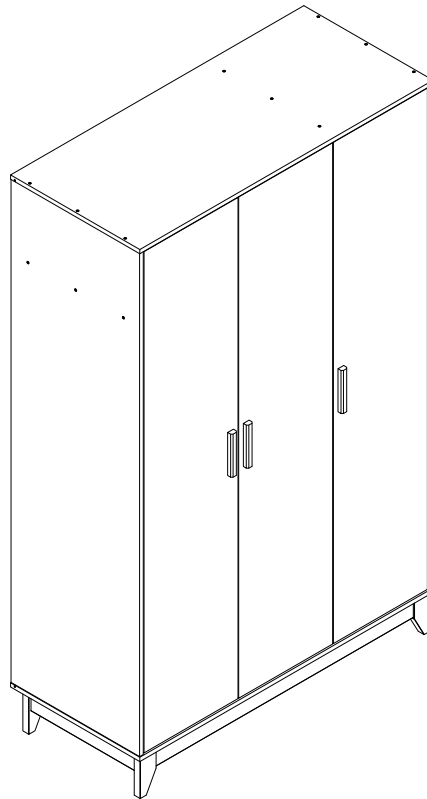

## **IMPORTANT FOR DOMESTIC USE ONLY**

**PLEASE READ BEFORE YOU CONTINUE FURTHER**

## **CARE AND MAINTENANCE**

After unpacking this product please keep the original packaging in case it needs to be returned for any reason.

- Please ensure all fittings and parts are present before commencing with assembly.
- Never drag or push products as this could cause damage to the joints making it inferior.
- We strongly recommend that you keep children away from your work area.
- We recommend that you lay a blanket or sheet on the floor to avoid damage to both your floor and the product.
- Assemble this product as close to its final position as possible.
- Do not place this product next to a radiator or in direct sunlight.
- Do not drag or push items across your high gloss furniture as this may cause the surface to scratch
- Wood is a natural product and may expand if subjected to damp and may shrink or crack if subjected to heat. Therefore it is recommended that room temperature is maintained, with no sudden temperature fluctuations.
- Make sure any spillage is wiped off immediately.
- Do not place hot or chilled items directly on to the surface, use a place mat or marking will occur.
- For general cleaning use a soft cotton or micro fibre cloth, and do not use detergents of any kind.
- From time to time it may be necessary to tighten fittings, regular inspections should be carried out.
- Do not place on a wet or damp floor as staining may occur to your floor.

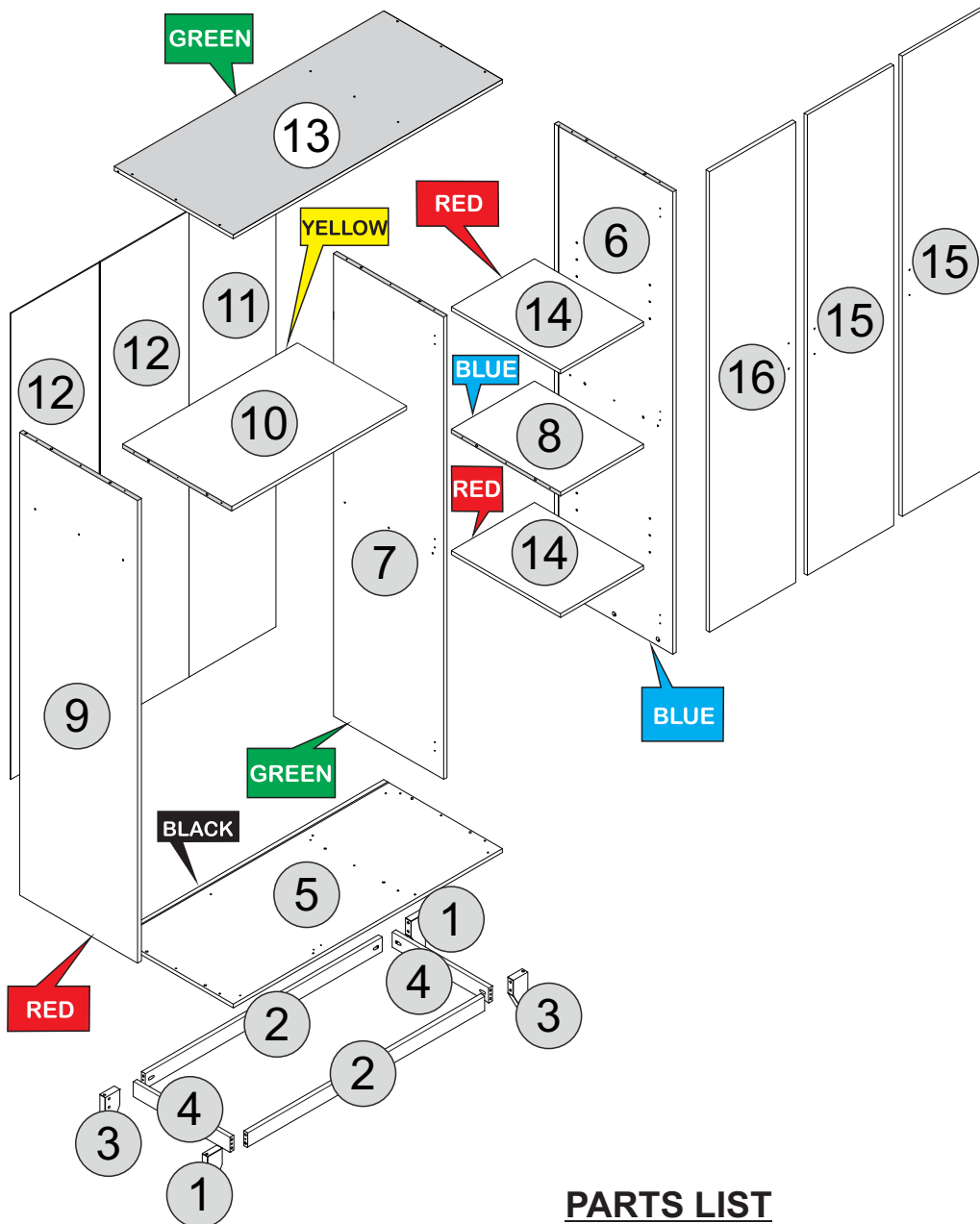

**TOOLS REQUIRED**

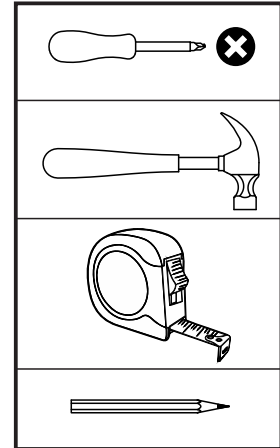







**PARTS LIST**

***Please Note:***

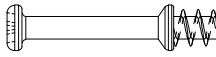
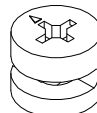
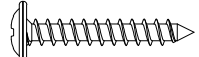
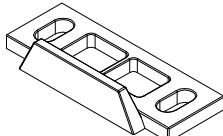
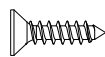
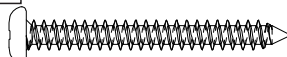
The below parts have all been stamped with the part number/color to help identify them during assembly.

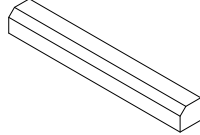
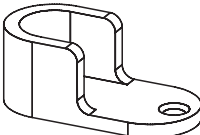
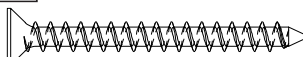
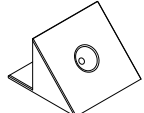
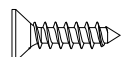
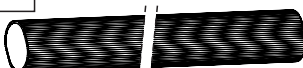
Part Nuner/Color	Part Code	Part Description	Quantity	Carton
1	S100-101-209-SP1-01	Left Leg	2	2/3
2	S100-101-209-SP1-02	Leg Support Front & Back	2	2/3
3	S100-101-209-SP1-03	Right Leg	2	2/3
4	S100-101-209-SP1-04	Leg Support Left & Right	2	2/3
5	S100-101-209-SP1-05	Base Panel - <b>BLACK</b>	1	2/3
6	S100-101-209-SP1-06	Right Side Panel - <b>BLUE</b>	1	1/3
7	S100-101-209-SP1-07	Division Panel - <b>GREEN</b>	1	1/3
8	S100-101-209-SP1-08	Fixed Smaller Shelf - <b>BLUE</b>	1	2/3
9	S100-101-209-SP1-09	Left Side Panel - <b>RED</b>	1	1/3
10	S100-101-209-SP1-10	Fixed Larger Shelf - <b>YELLOW</b>	1	2/3
11	S100-101-209-SP1-11	Smaller Back Panel	1	3/3
12	S100-101-209-SP1-12	Larger Back Panel	2	3/3
13	S100-101-209-SP1-13	Top Panel - <b>GREEN</b>	1	2/3
14	S100-101-209-SP1-14	Shelf - <b>RED</b>	2	2/3
15	S100-101-209-SP1-15	Right Door	2	3/3
16	S100-101-209-SP1-16	Left door	1	3/3

### FITTINGS LIST

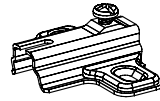
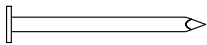
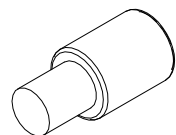
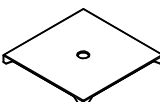
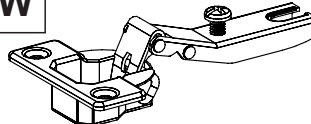
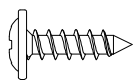
<p><b>A</b></p>  <p>Dowel Ø8,0 x 30mm (40x) 2/+</p>	<p><b>B</b></p>  <p>Cam Bolt (9x) 1/+</p>	<p><b>C</b></p>  <p>Cam Nut 15mm (9x) 1/+</p>	<p><b>D</b></p>  <p>Flan Head Screw Ø3,5 x 25mm (8x) 1/+</p>
<p><b>E</b></p>  <p>Door Stopper (2x)</p>	<p><b>F</b></p>  <p>Flat Head Screw Ø3,5 x 14mm (66x) 2/+</p>	<p><b>G</b></p>  <p>Pan Head Screw Ø4,0 x 35mm (8x) 1/+</p>	<p><b>H</b></p>  <p>Back Panel Strip 1753 mm (1x)</p>
<p><b>I</b></p>  <p>Handle (3x)</p>	<p><b>J</b></p>  <p>Hanging Rail Support (2x)</p>	<p><b>K</b></p>  <p>Flat Head Screw Ø4,0 x 50mm (29x) 2/+</p>	<p><b>L</b></p>  <p>Plastic Corner Bracket (22x) 2/+</p>
<p><b>M</b></p>  <p>Flat Head Screw Ø3,5 x 16mm (22x) 2/+</p>	<p><b>N</b></p>  <p>Haging Rail 758x28x16mm (1x)</p>	<p><b>O</b></p>  <p>Washer (4x) 1/+</p>	<p><b>P</b></p>  <p>Hole Plugs (29x) 2/+</p>
<p><b>Q</b></p>  <p>Glue (3x)</p>	<p><b>R</b></p>  <p>Strap (2x)</p>	<p><b>S</b></p>  <p>Hinge Plate (9x)</p>	<p><b>T</b></p>  <p>Nail 10 x 10 (14x) 2/+</p>
<p><b>U</b></p>  <p>Support Pin (8x)</p>	<p><b>V</b></p>  <p>Back Panel Bracket (8x) 1/+</p>	<p><b>W</b></p>  <p>Hinge (9x)</p>	<p><b>X</b></p>  <p>Flan Head Screw Ø3,5 x 12mm (4x) 1/+</p>

### TIPS FOR FITTINGS CAM-LOCKS

WHEN FITTING CAM NUT, ENSURE STARTING POSITION IS CORRECT BEFORE YOU INSERT CONNECTING CAM BOLT TURN CLOCKWISE UNTIL SECURE

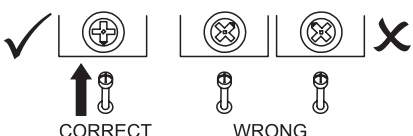

↑ CORRECT      ↓ WRONG

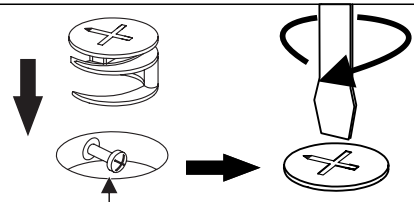

Cam bolt head needs to be in centre

**CAMBOLT**  
Tighten until shoulder in flush with panel. Do not overtighten or undertighten (see example beside)

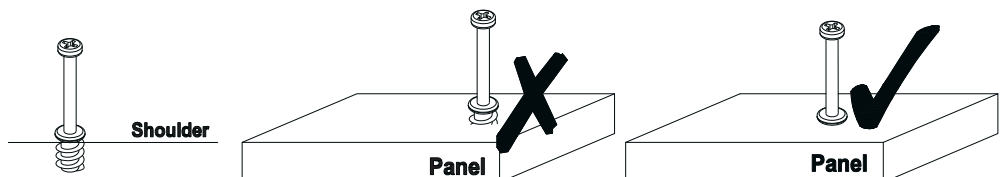

# STEP 1

## PARTS REQUIRED

1 - LEFT LEG x2

3 - RIGHT LEG x2

## HARDWARE REQUIRED

A  20  
Ø8,0 x 30mm

Q  01  
GLUE

## TOOLS REQUIRED

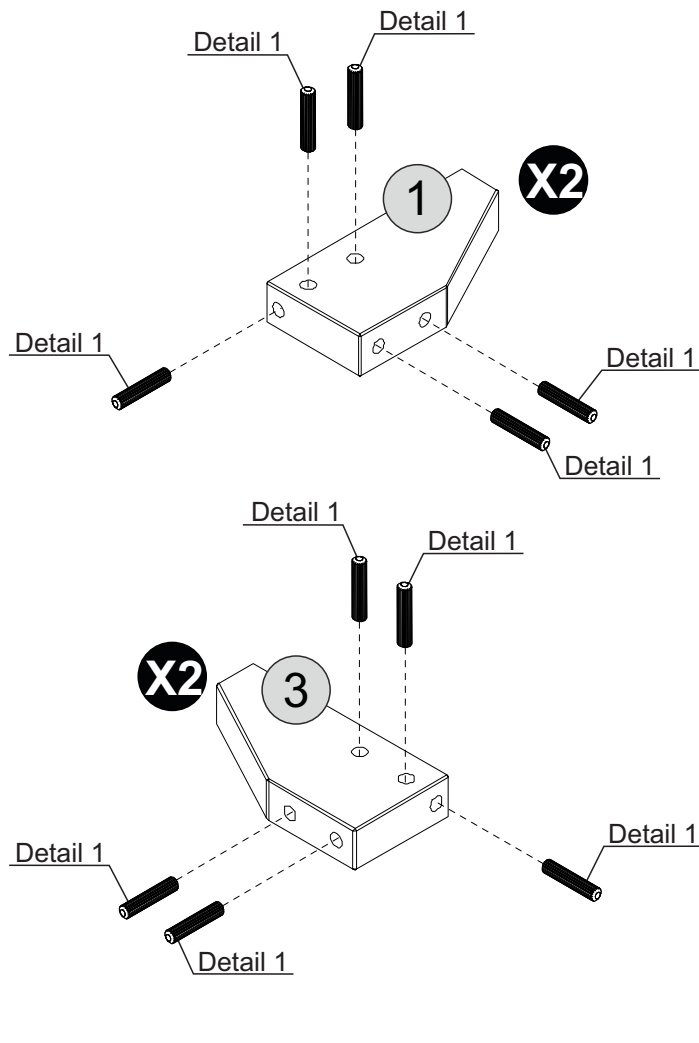
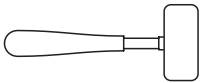

# STEP 2

## PARTS REQUIRED

1 - LEFT LEG x2

2 - LEG SUPPORT FRONT&BACK x2

3 - RIGHT LEG x2

## HARDWARE REQUIRED

G  04  
Ø4,0 x 35mm

Q  01  
GLUE

## TOOLS REQUIRED

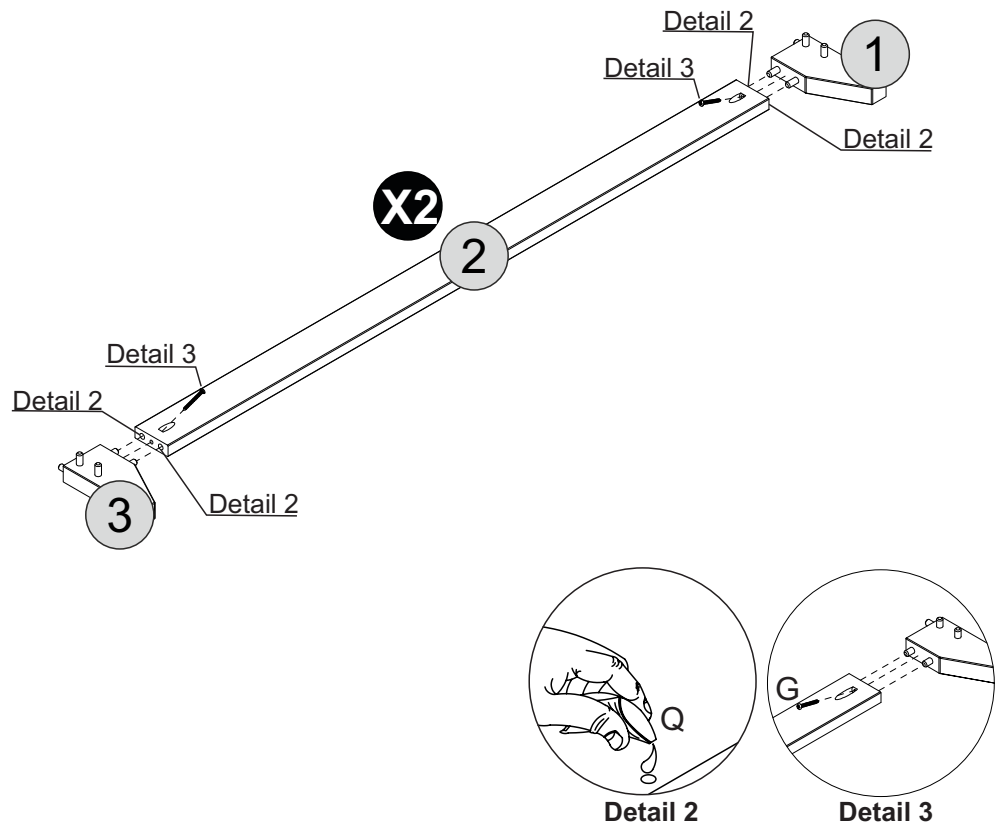
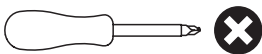

# STEP 3

## PARTS REQUIRED

4 - LEG SUPPORT LEFT & RIGHT x2

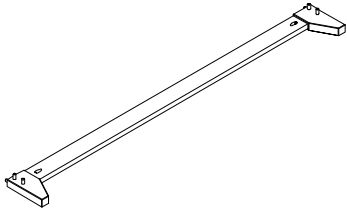

## HARDWARE REQUIRED

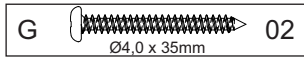

## TOOLS REQUIRED

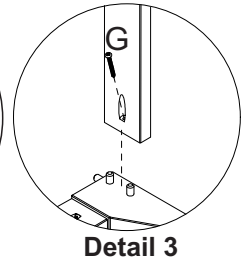
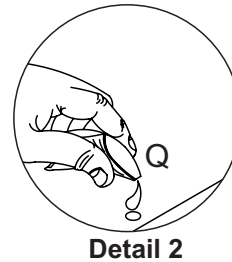
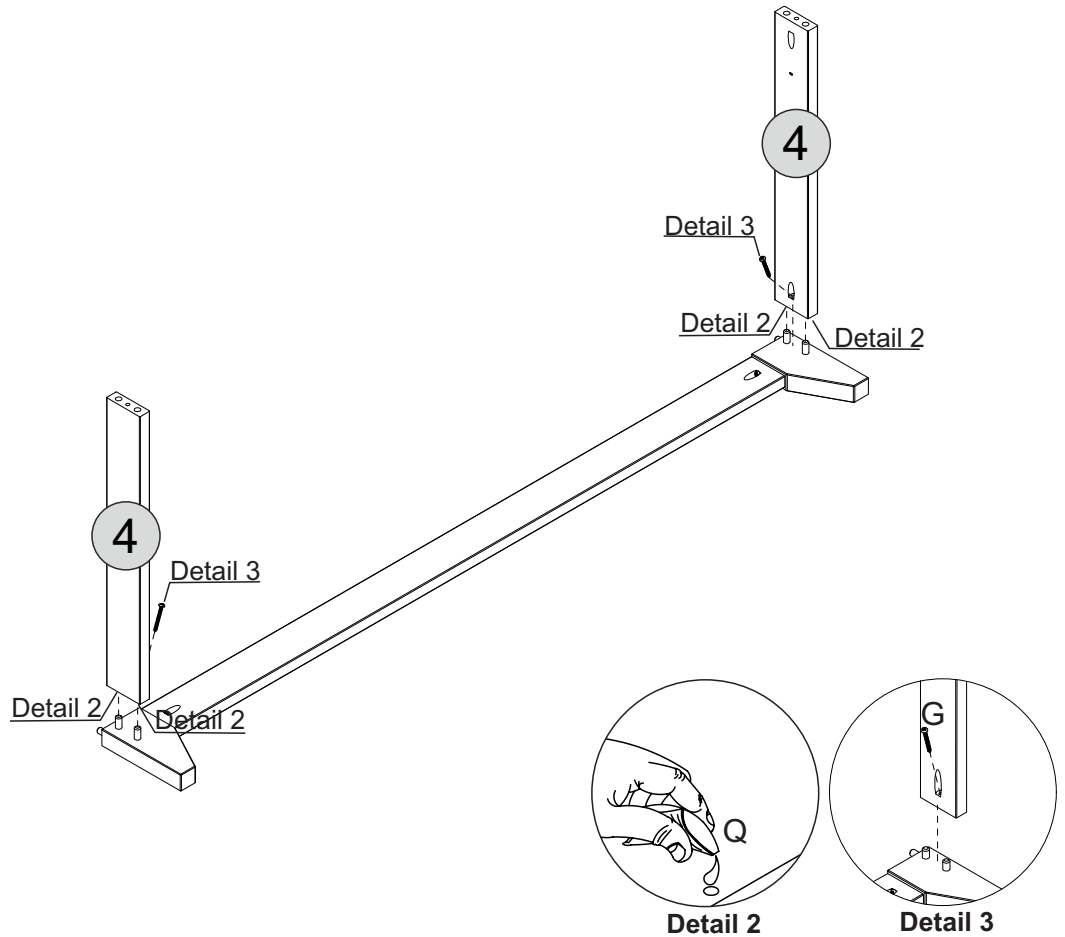

# STEP 4

## PARTS REQUIRED

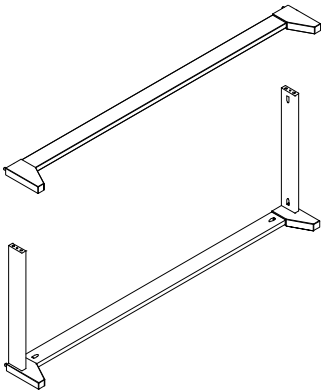

## HARDWARE REQUIRED

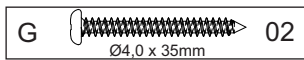

## TOOLS REQUIRED

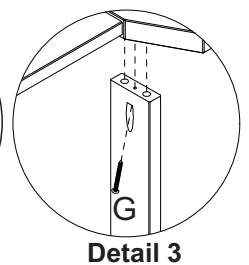
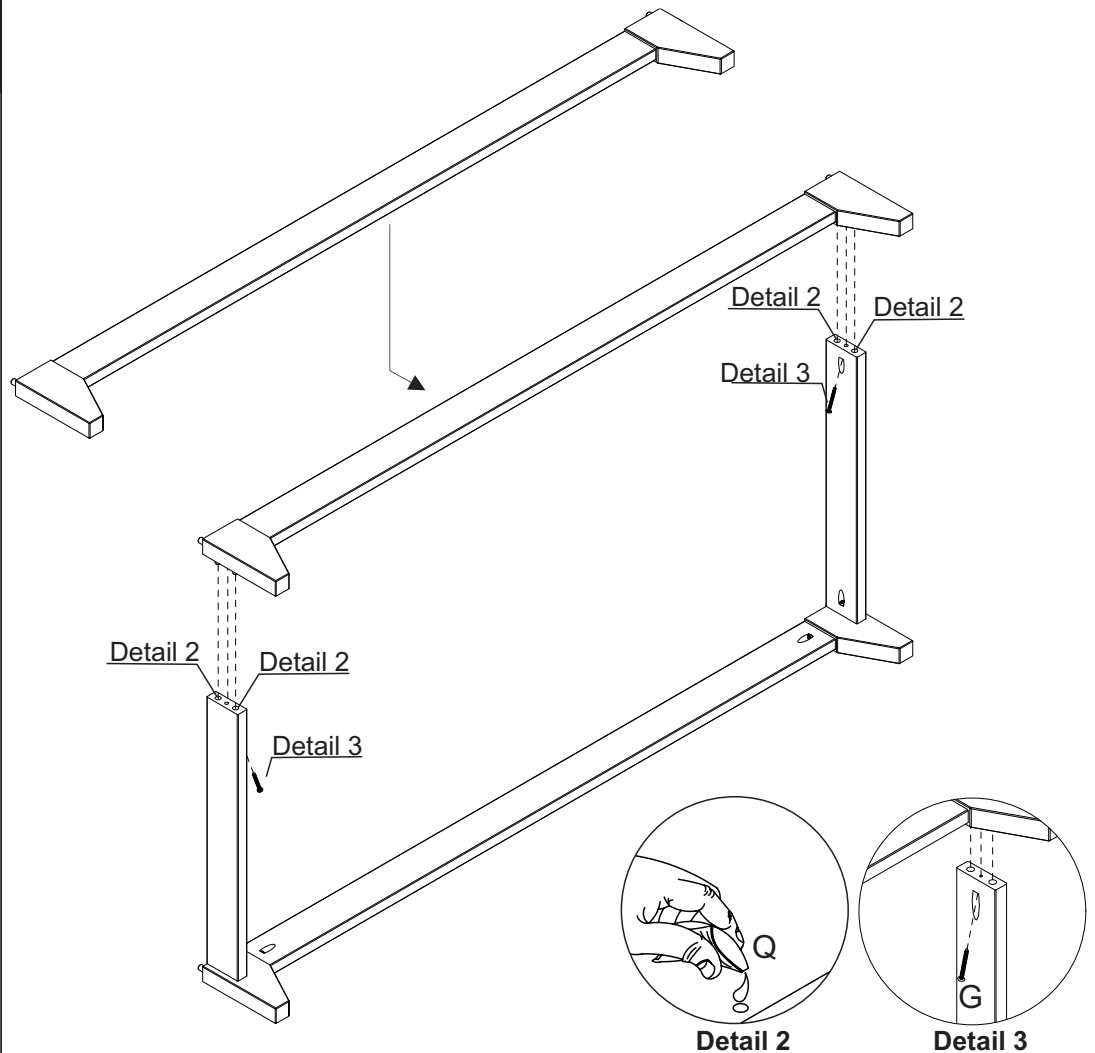

# STEP 5

## PARTS REQUIRED

9 - LEFT SIDE PANEL (RED) x1

## HARDWARE REQUIRED

A  04  
Ø8,0 x 30mm

Q  01  
GLUE

## TOOLS REQUIRED

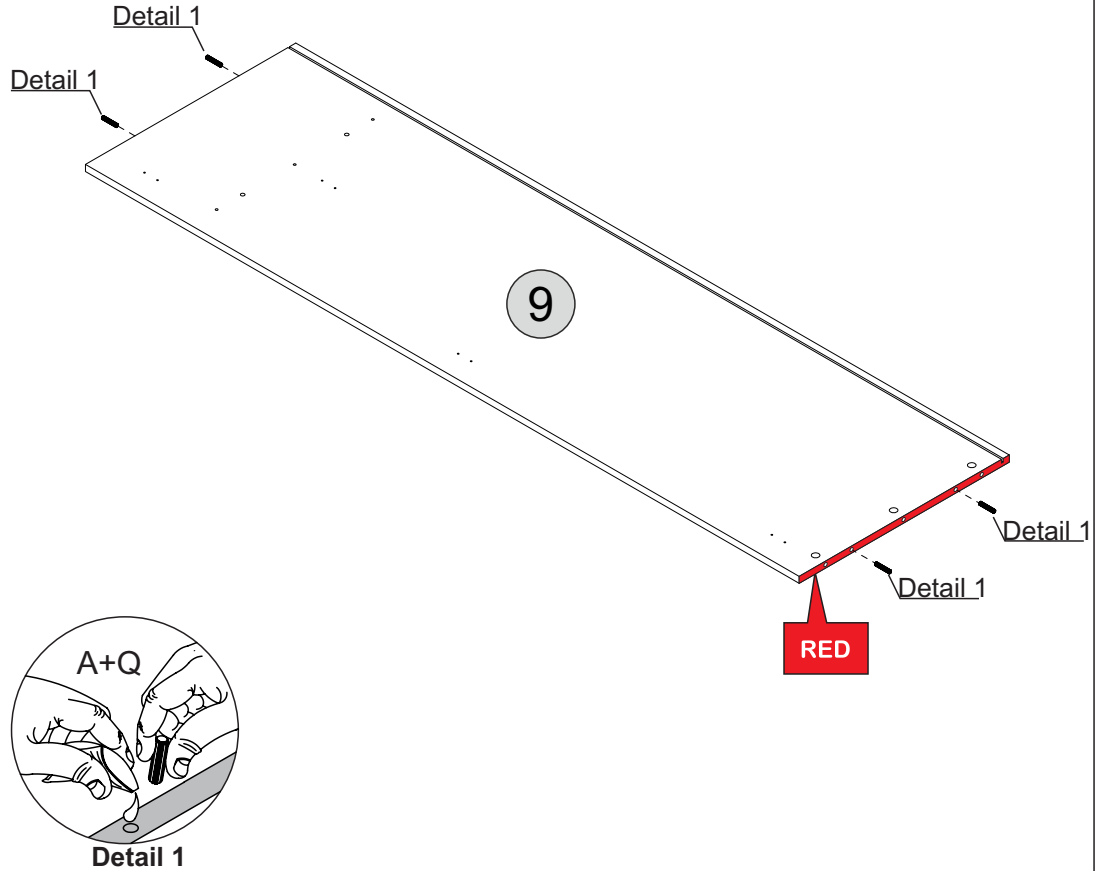
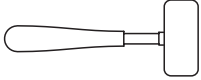

# STEP 6

## PARTS REQUIRED

9- LEFT SIDE PANEL (RED) x1

## HARDWARE REQUIRED

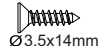
F  08  
Ø3,5x14mm

J  01

S  03

## TOOLS REQUIRED

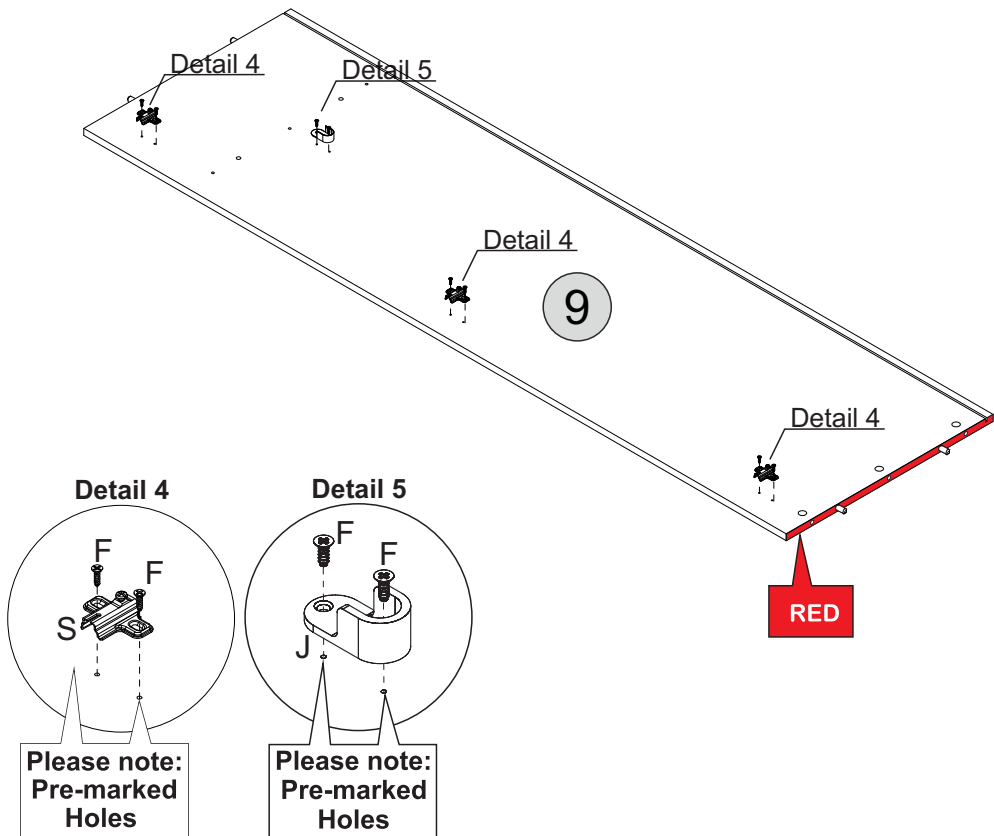



# STEP 7

## PARTS REQUIRED

7 - DIVISION PANEL (GREEN) x1

## HARDWARE REQUIRED

A		04
Q		01
U		04

## TOOLS REQUIRED

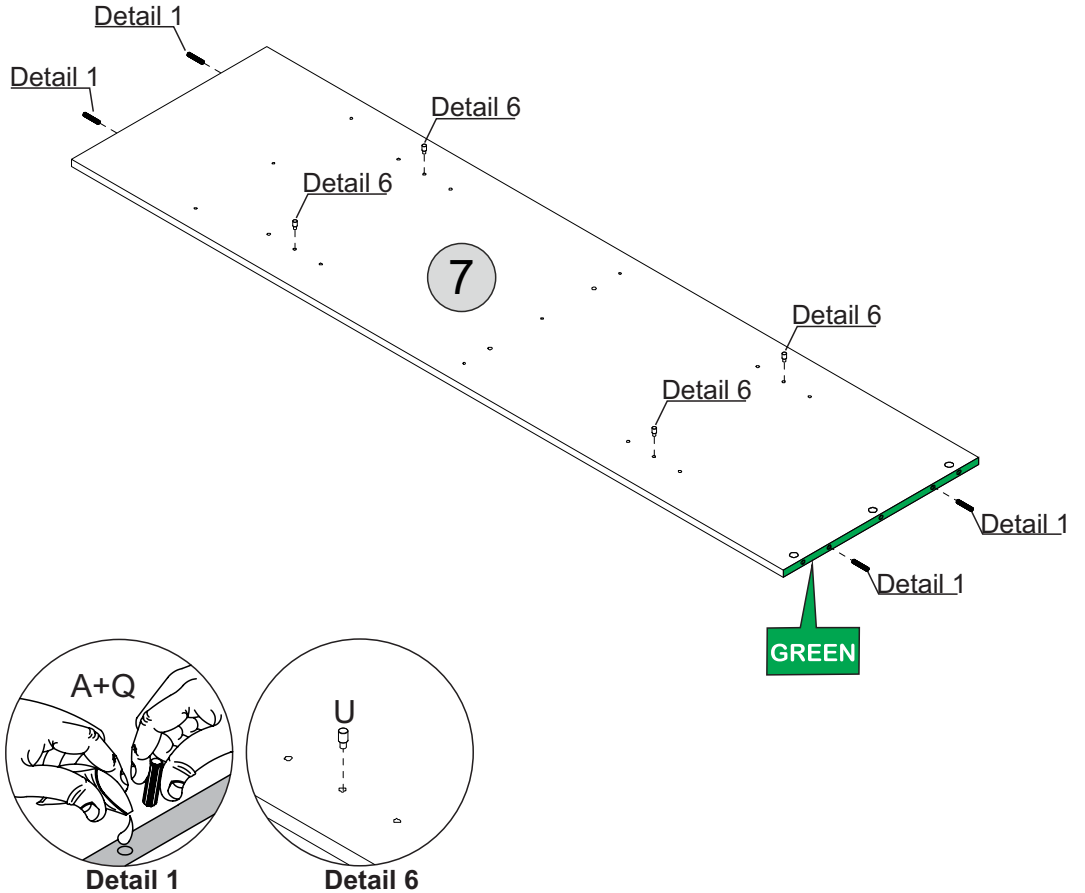
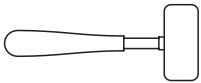



# STEP 8

## PARTS REQUIRED

7 - DIVISION PANEL (GREEN) x1

## HARDWARE REQUIRED

F		08
J		01
S		03

## TOOLS REQUIRED

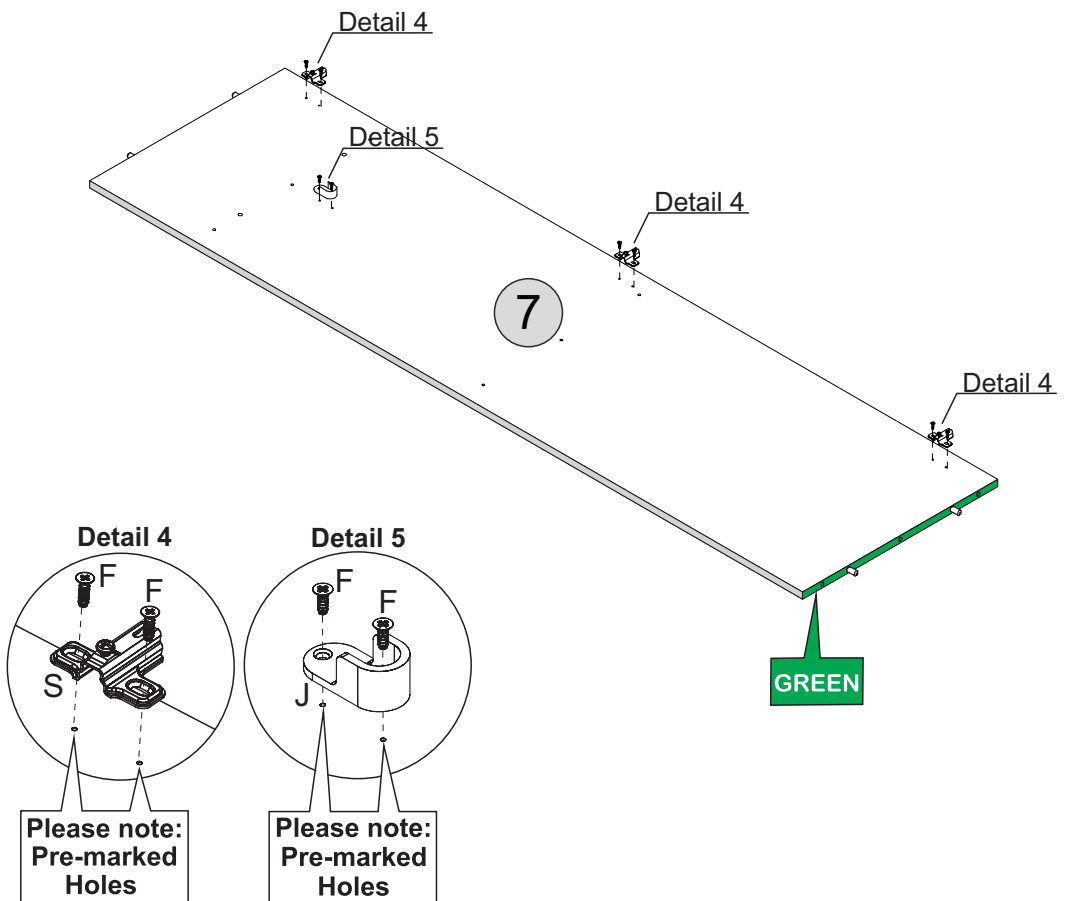



# STEP 9

## PARTS REQUIRED

6 - RIGHT SIDE PANEL (BLUE) x1

## HARDWARE REQUIRED

A		04
Q		01
U		04

## TOOLS REQUIRED

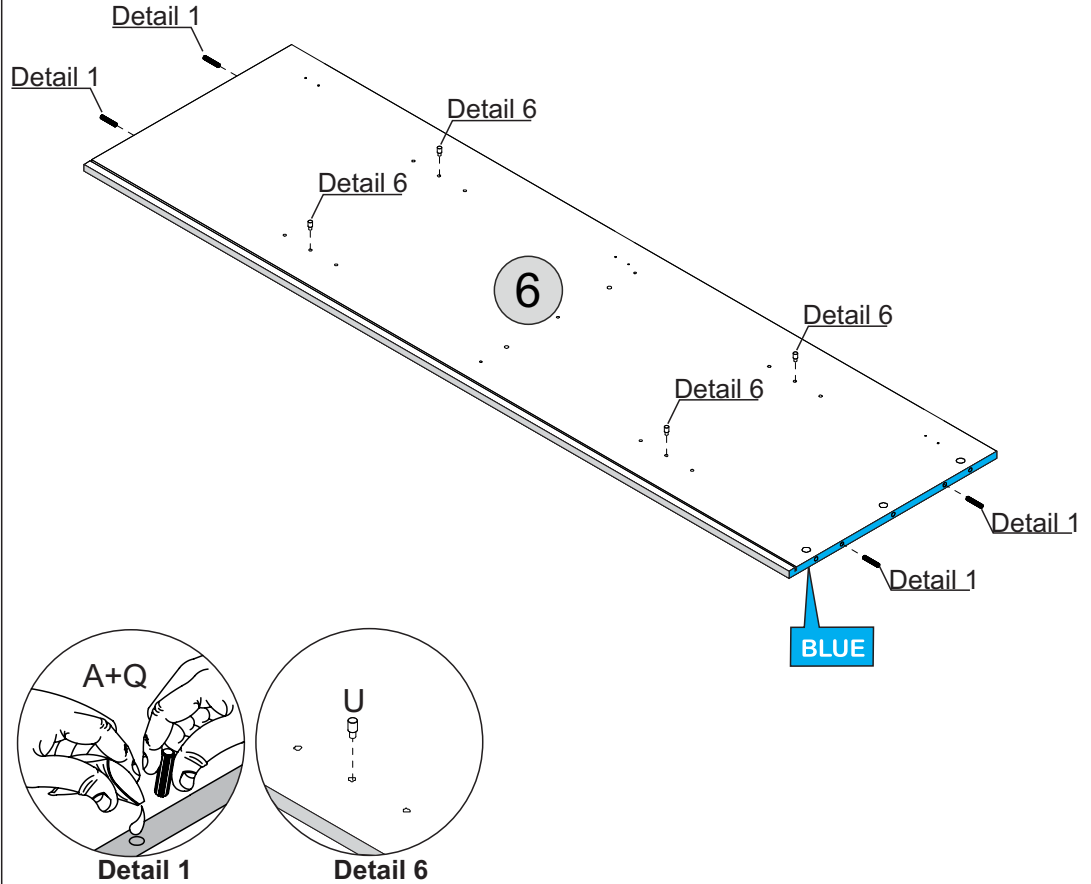
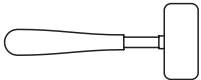



# STEP 10

## PARTS REQUIRED

6 - RIGHT SIDE PANEL (BLUE) x1

## HARDWARE REQUIRED

F		06
S		03

## TOOLS REQUIRED

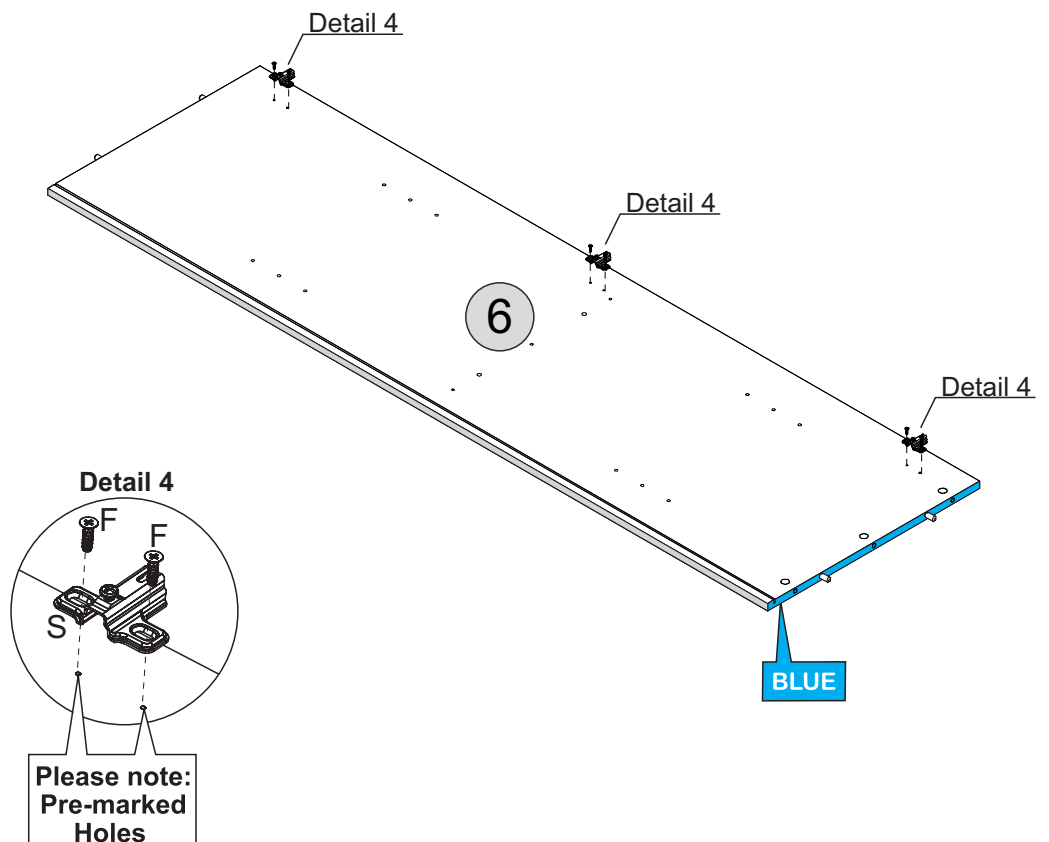



# STEP 11

## PARTS REQUIRED

8 - FIXED SMALLER SHELF (BLUE) x1

10- FIXED LARGER SHELF (YELLOW) x1

## HARDWARE REQUIRED

A  08  
Ø8,0 x 30mm

Q  01  
GLUE

## TOOLS REQUIRED

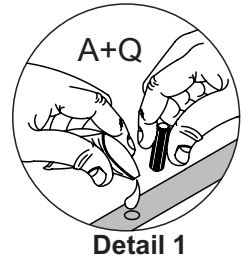
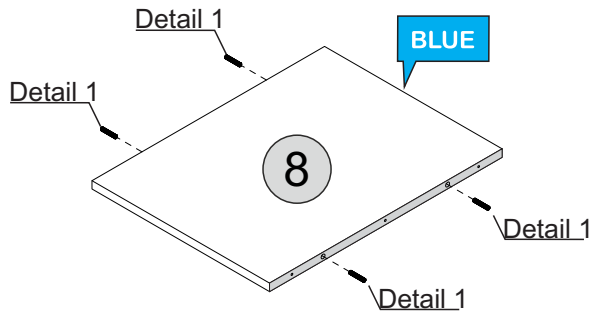
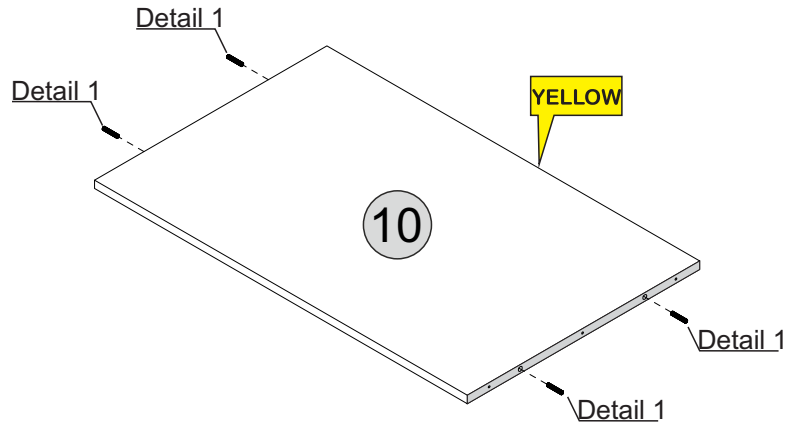
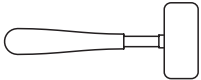

# STEP 12

## PARTS REQUIRED

5 - BASE PANEL (BLACK) x1

13 - TOP PANEL (GREEN) x1

## HARDWARE REQUIRED

E  02

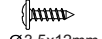
X  04  
Ø3,5x12mm

## TOOLS REQUIRED

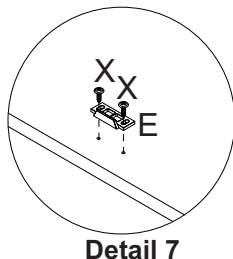
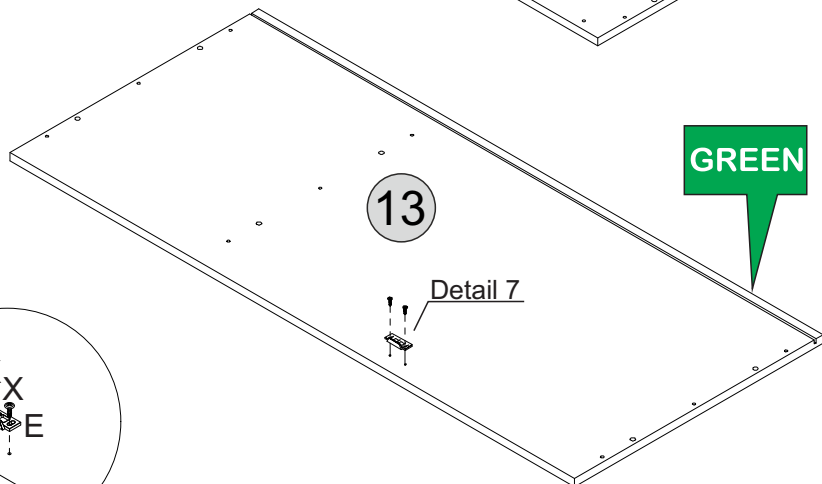
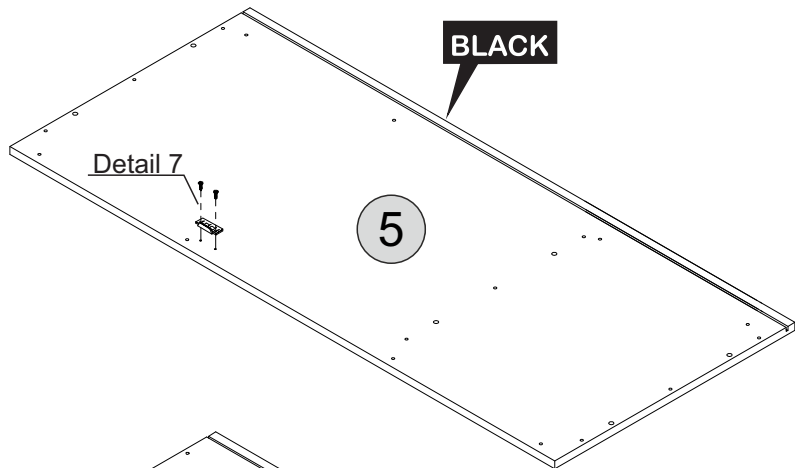

# STEP 13

## PARTS REQUIRED

5 - BASE PANEL (BLACK) x1

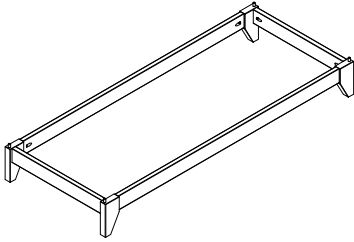

## HARDWARE REQUIRED

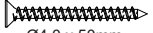
K  08  
Ø4,0 x 50mm

P  08

Q  01

## TOOLS REQUIRED

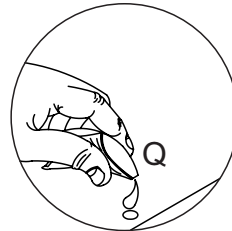
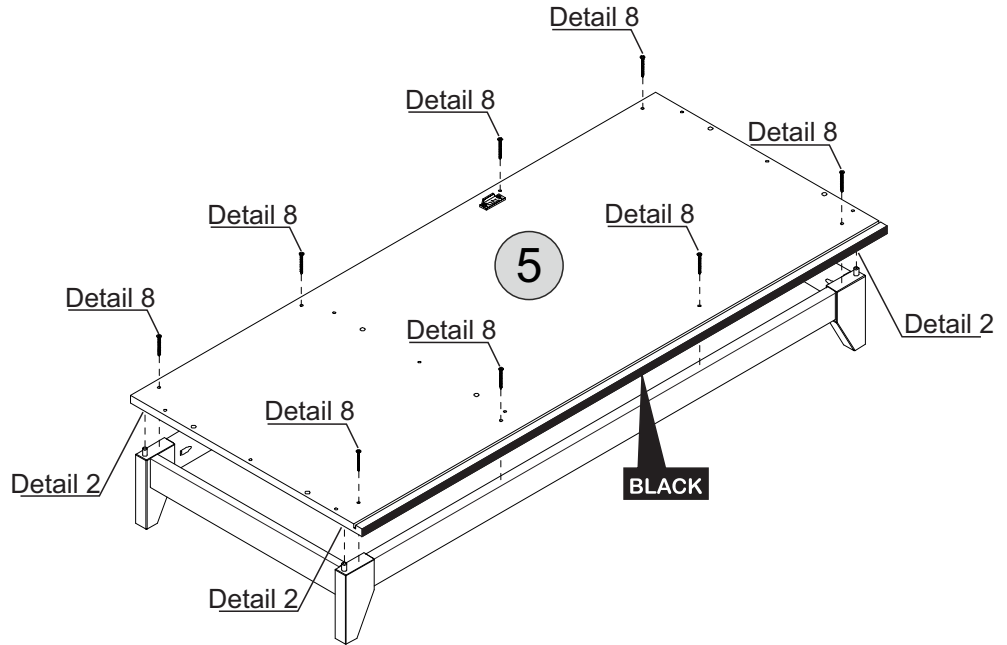
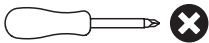

Detail 2

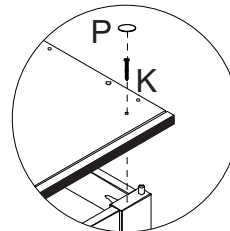

Detail 8

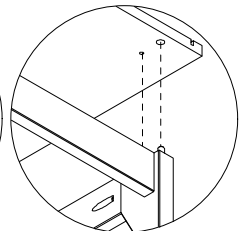

# STEP 14

## PARTS REQUIRED

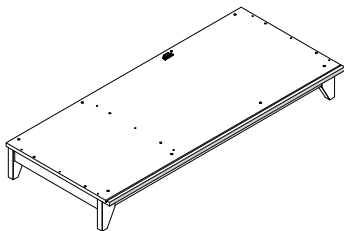

## HARDWARE REQUIRED

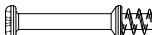
B  09

## TOOLS REQUIRED

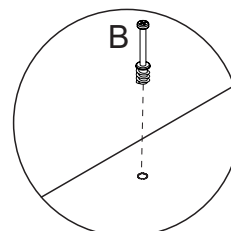
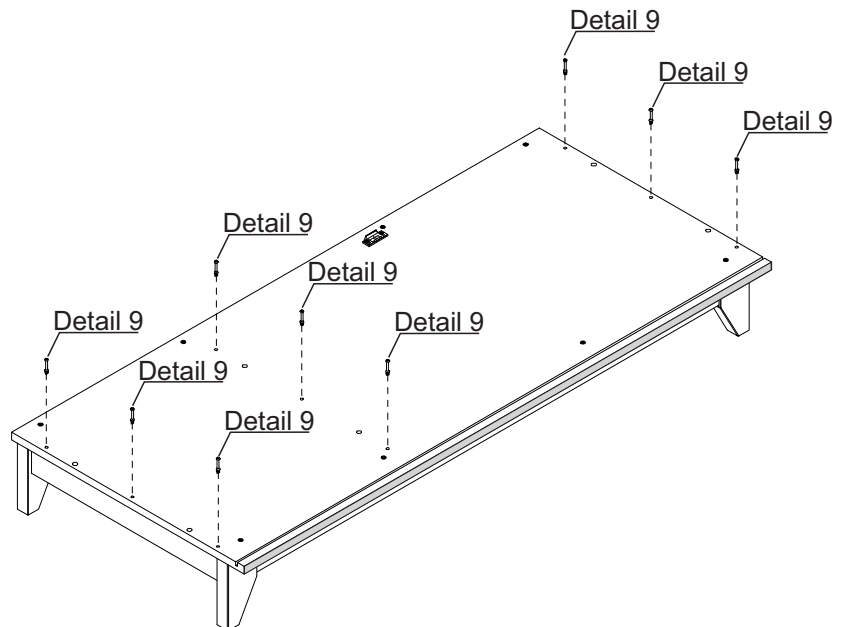

Detail 9

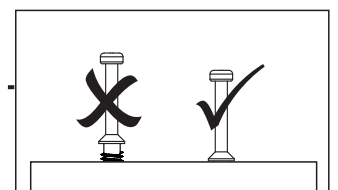



# STEP 15

**PARTS REQUIRED**

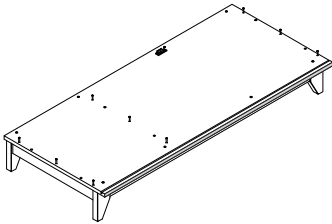
6 - RIGHT SIDE PANEL (BLUE) x1



**HARDWARE REQUIRED**

- C  Ø15mm 03
- Q  GLUE 01

**TOOLS REQUIRED**

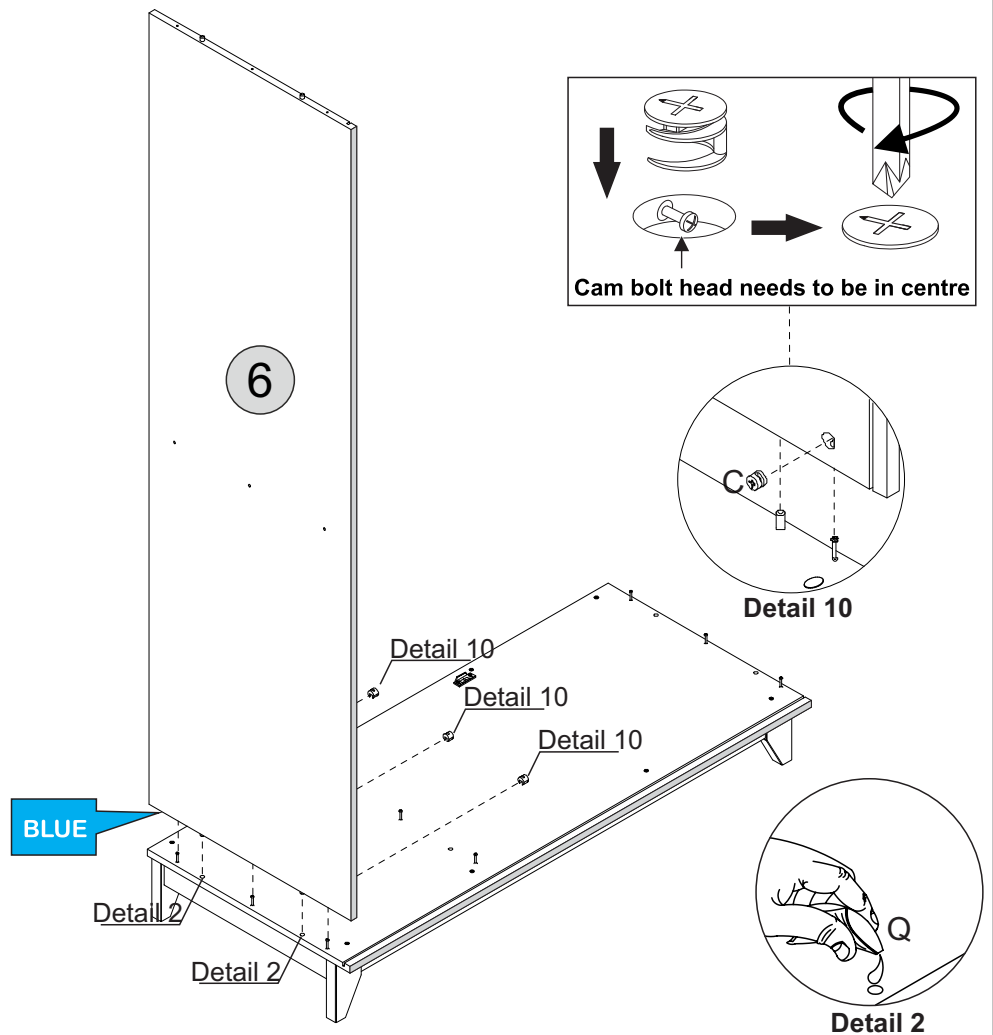
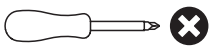



# STEP 16

**PARTS REQUIRED**

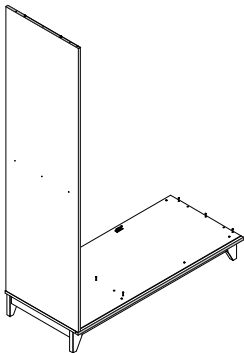
7 - DIVISION PANEL (GREEN) x1



**HARDWARE REQUIRED**

- C  Ø15mm 03
- Q  GLUE 01

**TOOLS REQUIRED**

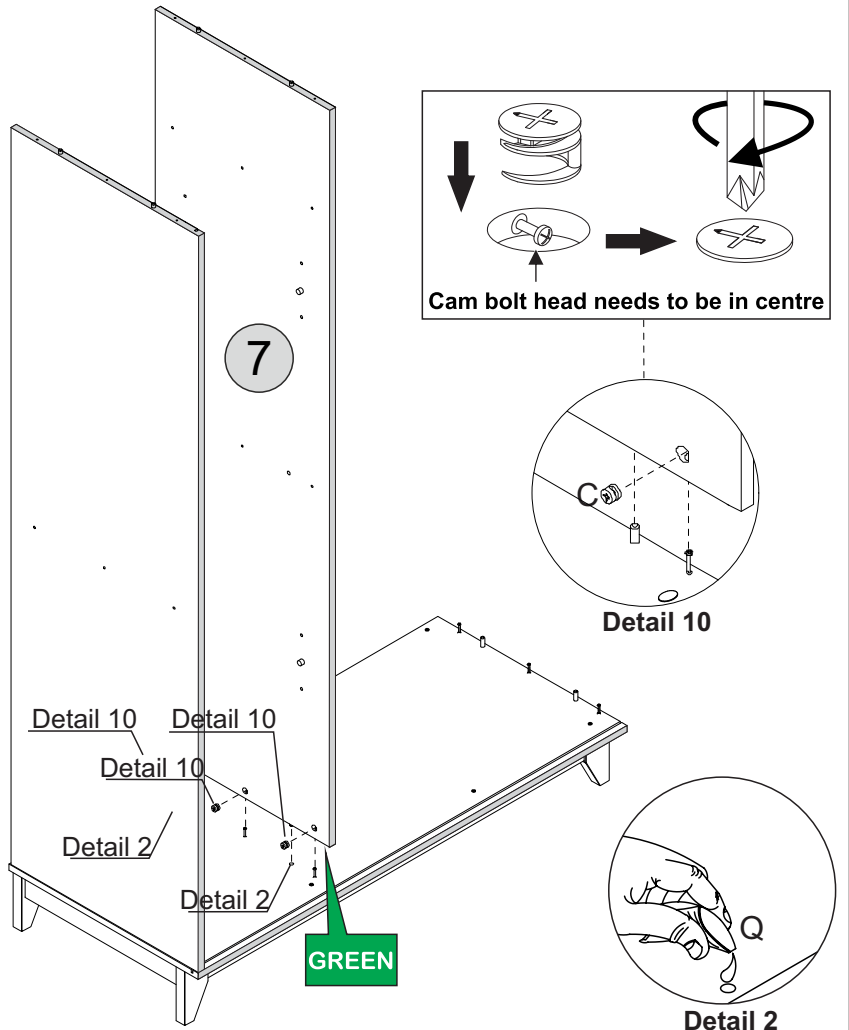
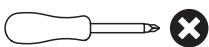

# STEP 17

## PARTS REQUIRED

8 - FIXED SMALLER SHELF (BLUE) x1

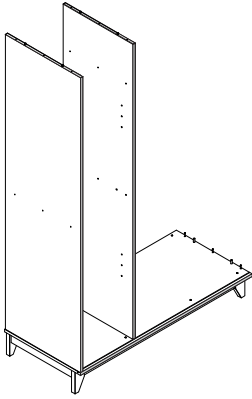

## HARDWARE REQUIRED

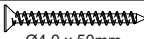
K  06  
Ø4,0 x 50mm

P  06

Q  01

## TOOLS REQUIRED

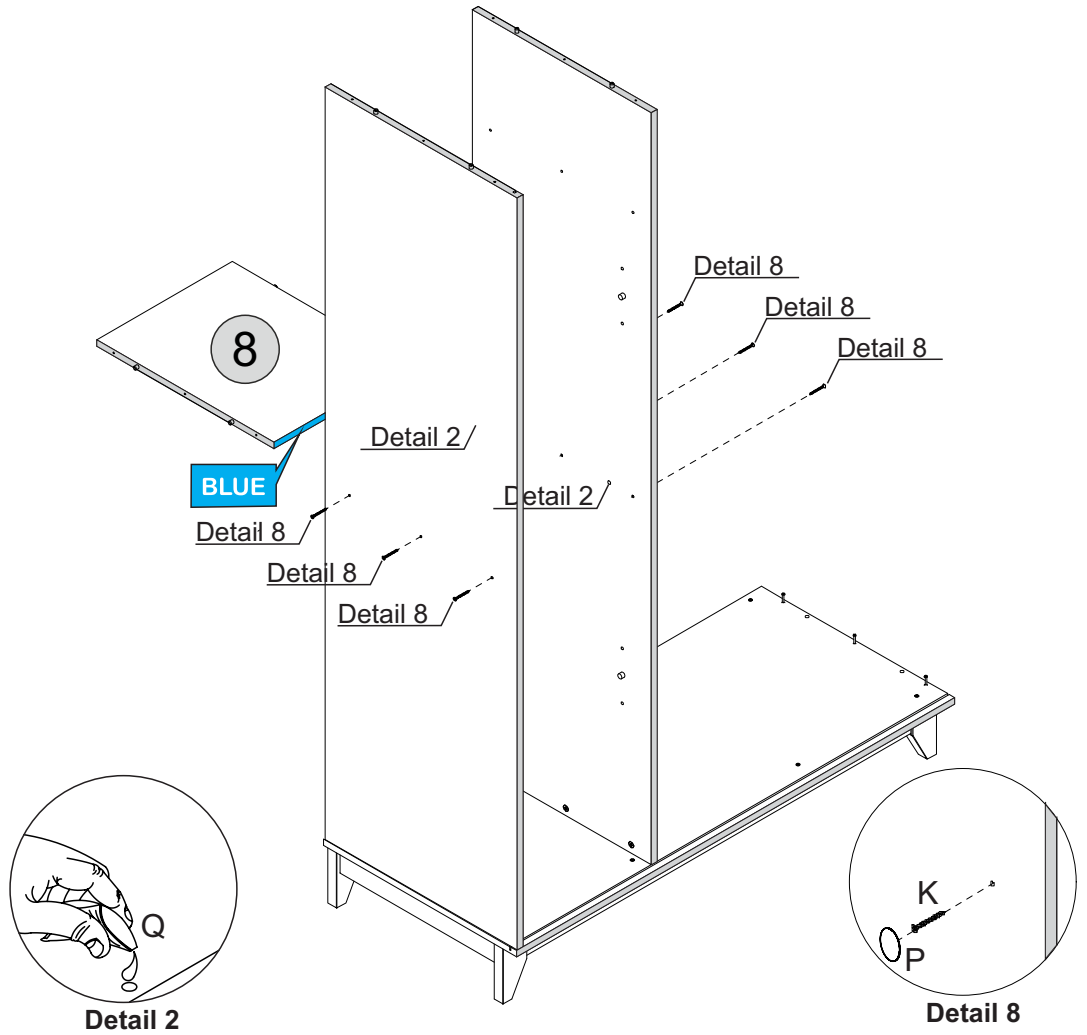
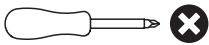

# STEP 18

## PARTS REQUIRED

9 - LEFT SIDE PANEL (RED) x1

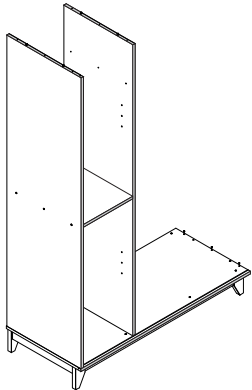

## HARDWARE REQUIRED

C  Ø15mm 03

Q  01

## TOOLS REQUIRED

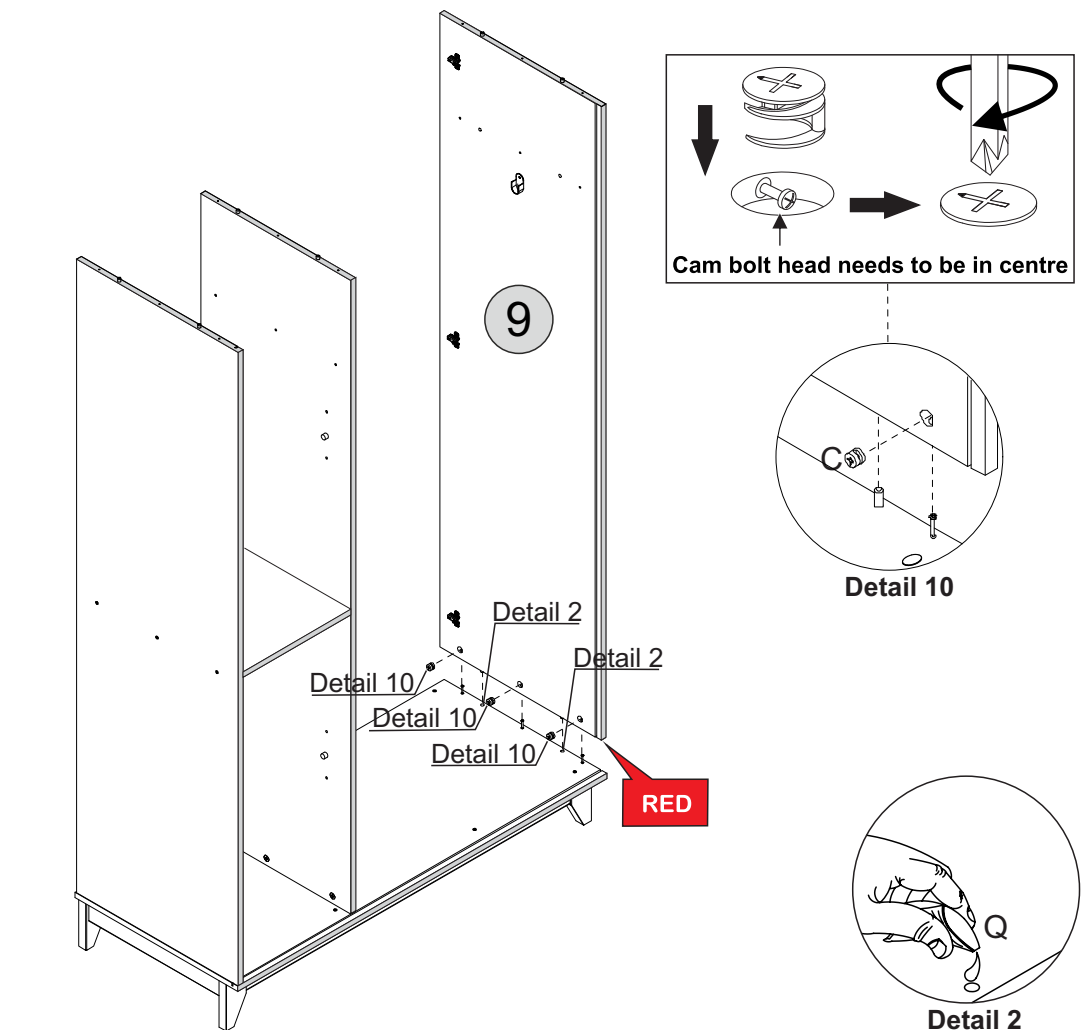
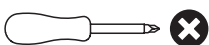



# STEP 19

## PARTS REQUIRED

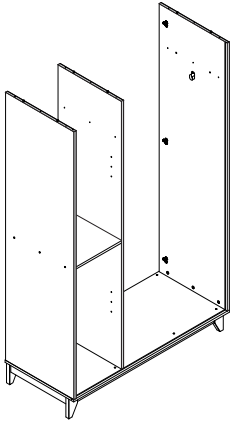
10 - FIXED LARGER SHELF (YELLOW) x1

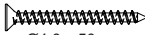

## HARDWARE REQUIRED

K	 Ø4,0 x 50mm	06
P		06
Q	 GLUE	01

## TOOLS REQUIRED

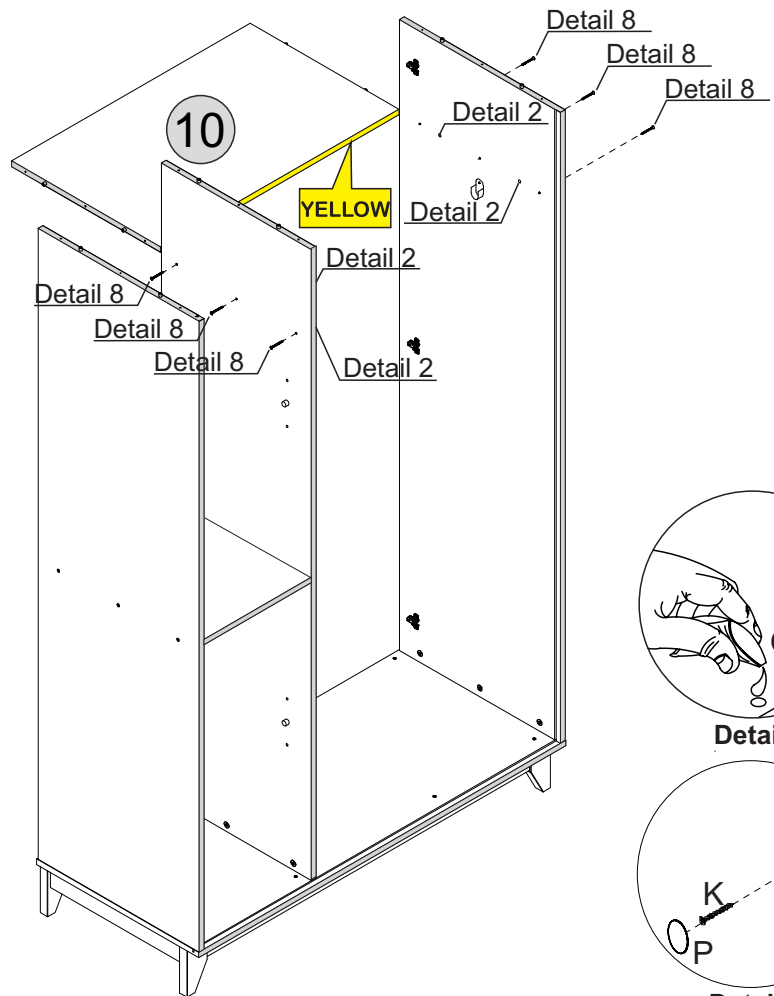

# STEP 20

## PARTS REQUIRED

11 - SMALLER BACK PANEL x1

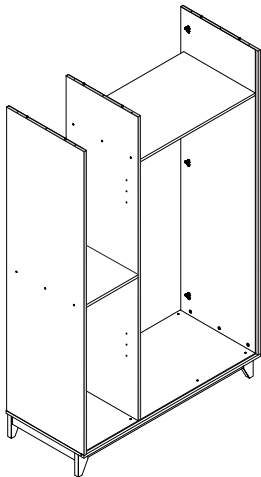

## HARDWARE REQUIRED

## TOOLS REQUIRED

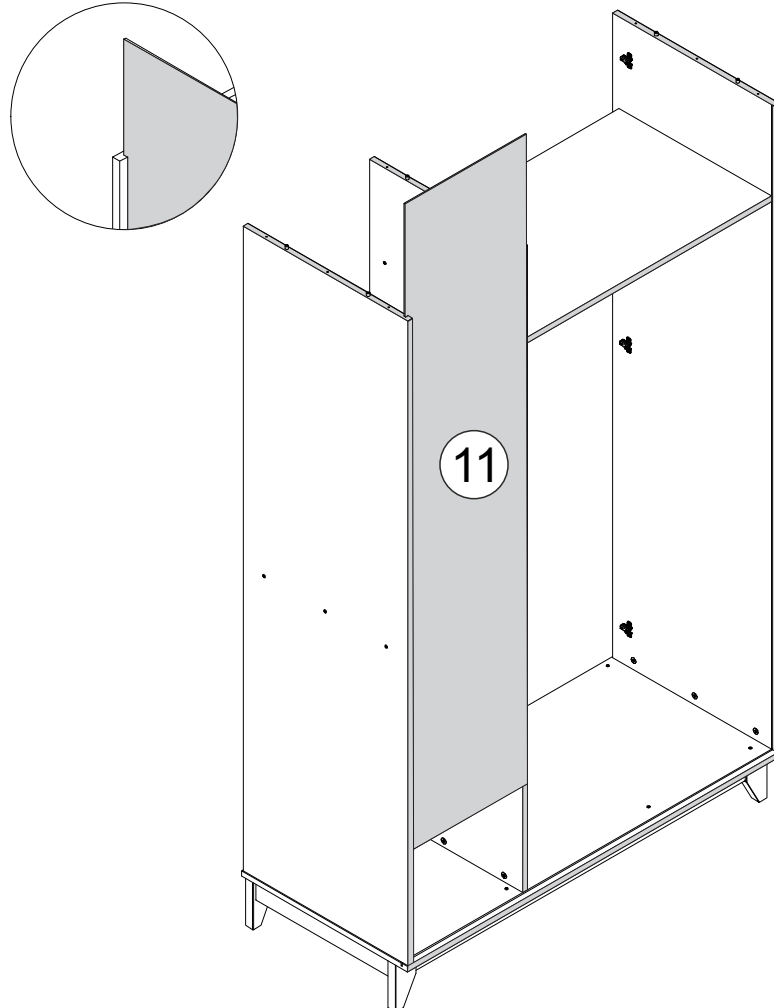

# STEP 21

## PARTS REQUIRED

12 - LARGER BACK PANEL x2

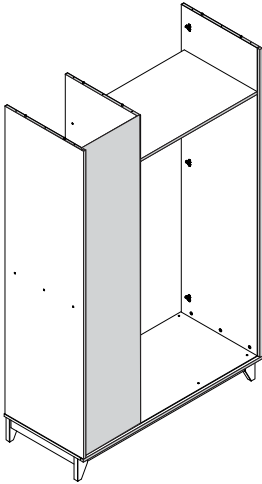

## HARDWARE REQUIRED

H 01

## TOOLS REQUIRED

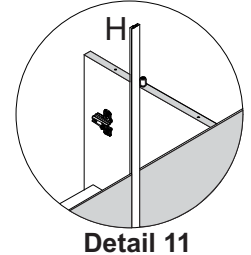
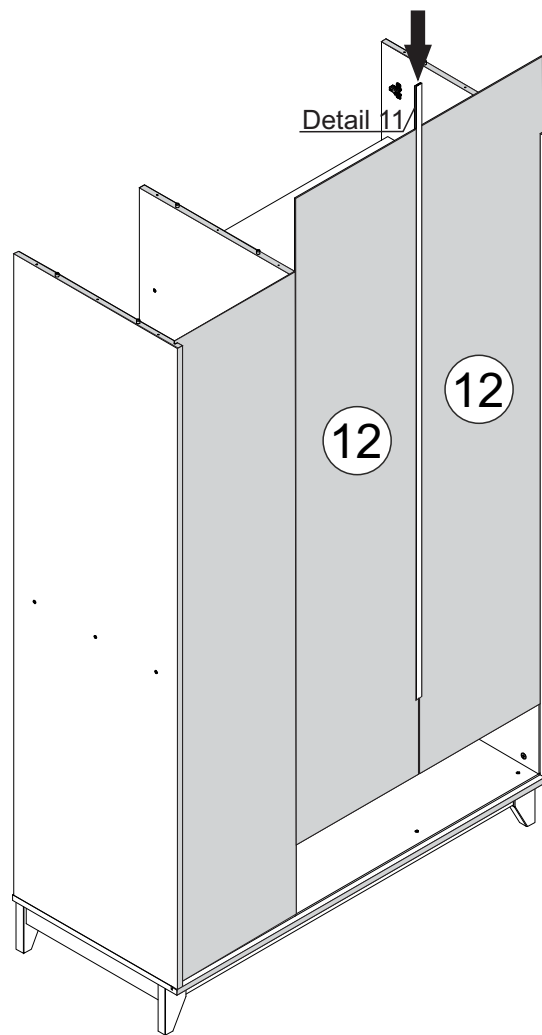

# STEP 22

## PARTS REQUIRED

13 - TOP PANEL (GREEN) x1

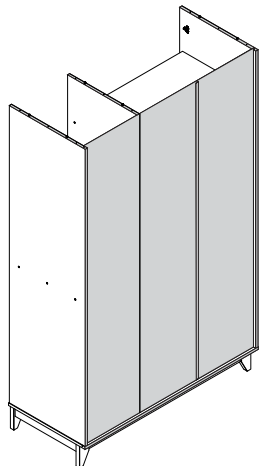

## HARDWARE REQUIRED

K Ø4,0 x 50mm 09

Q GLUE 01

## TOOLS REQUIRED

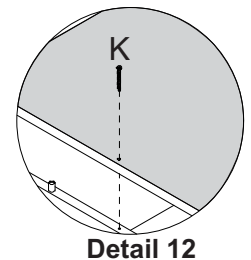
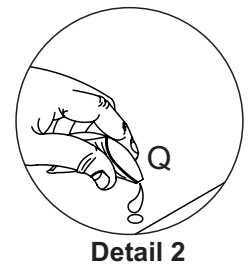
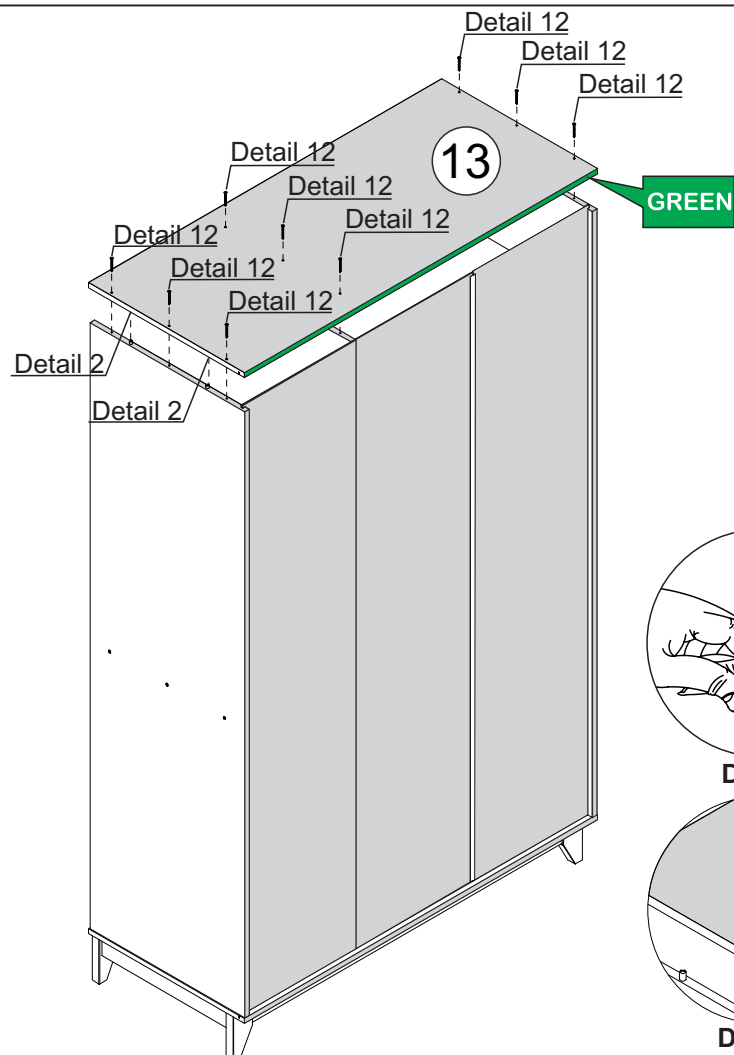

# STEP 23

## PARTS REQUIRED

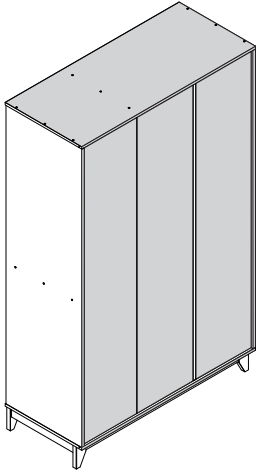

## HARDWARE REQUIRED

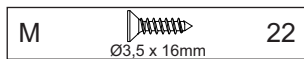

## TOOLS REQUIRED

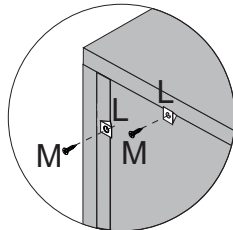
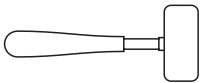

Detail 13

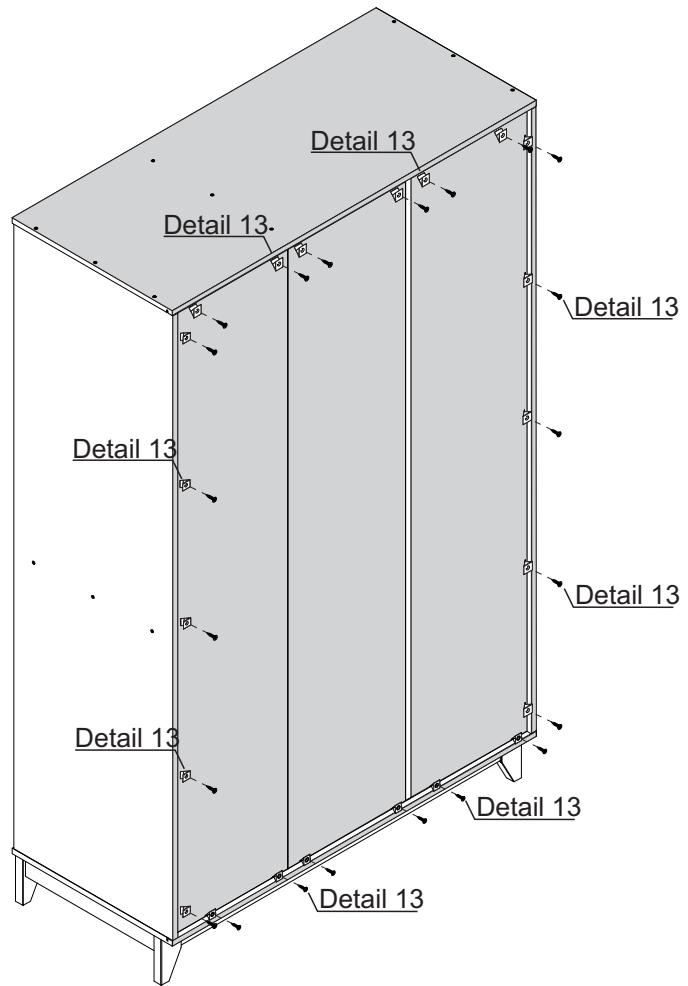

# STEP 24

## PARTS REQUIRED

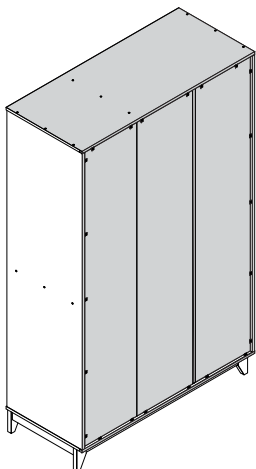

## HARDWARE REQUIRED

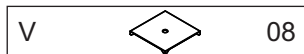
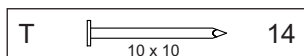

## TOOLS REQUIRED

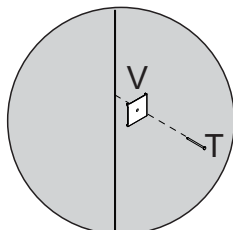
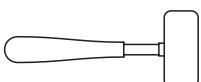

Detail 15

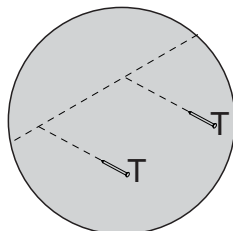

Detail 14

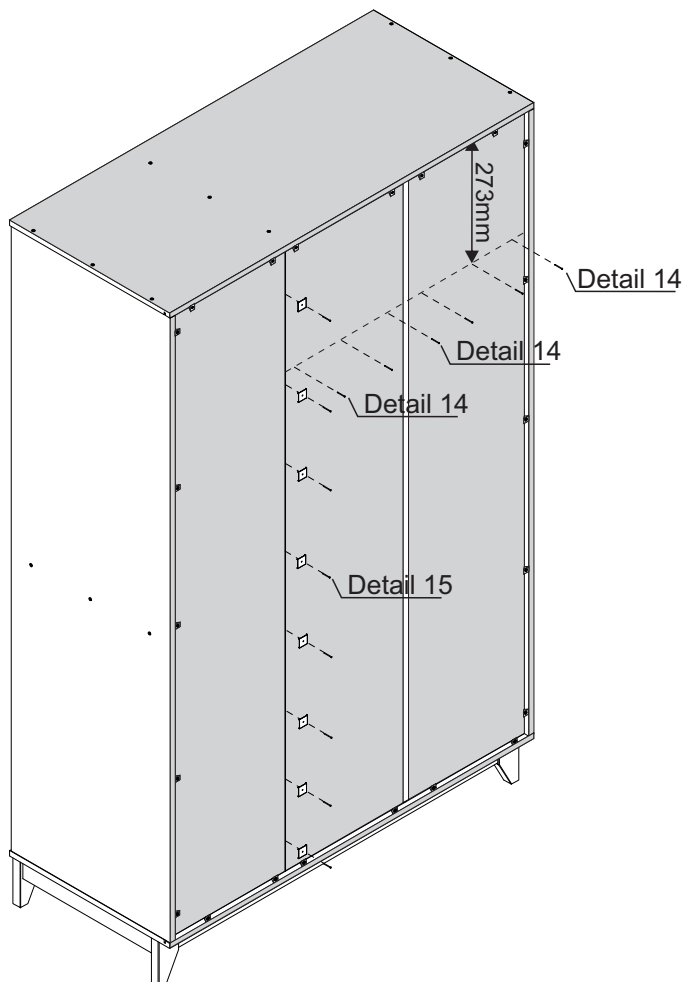

# STEP 25

PARTS REQUIRED

HARDWARE REQUIRED

TOOLS REQUIRED

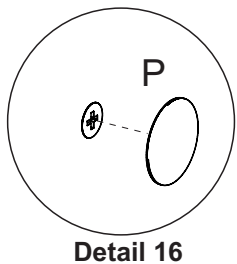
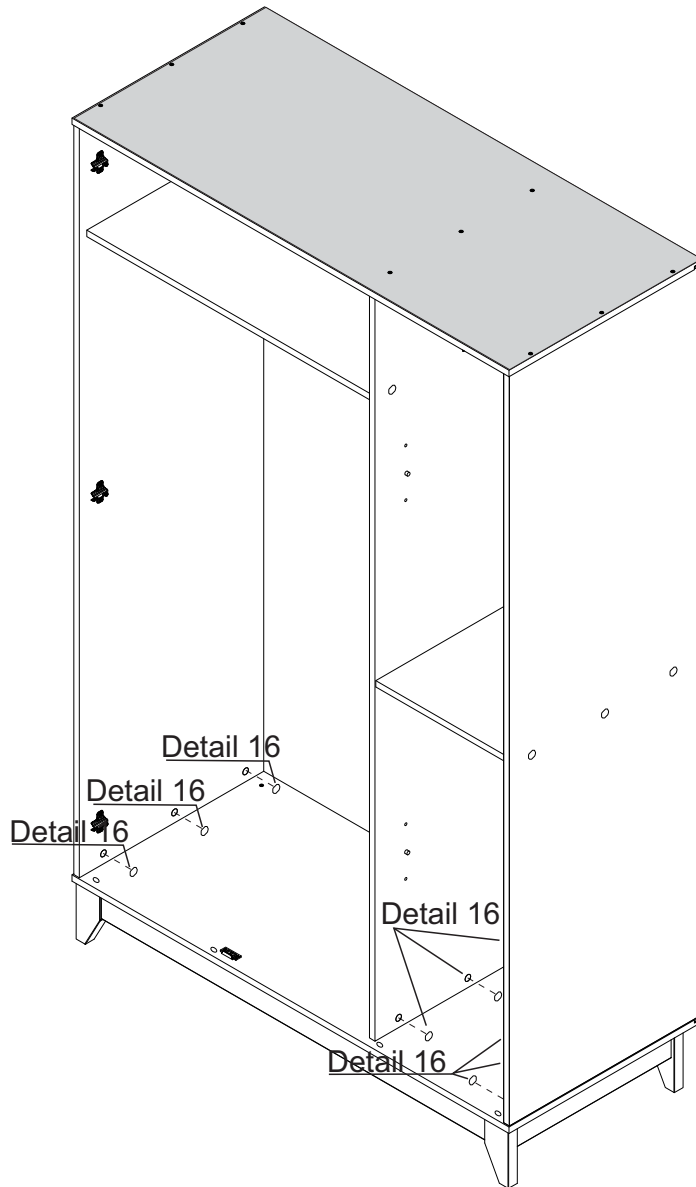
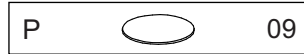
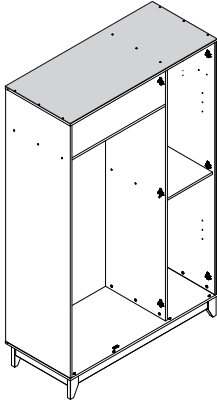

Detail 16



# STEP 26

## PARTS REQUIRED

14 - SHELF (RED) x2

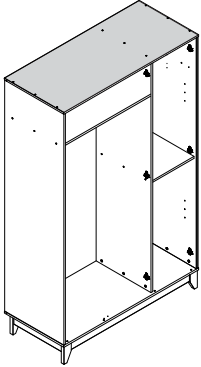

## HARDWARE REQUIRED

N  01

## TOOLS REQUIRED

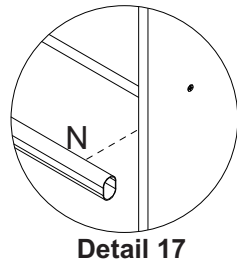
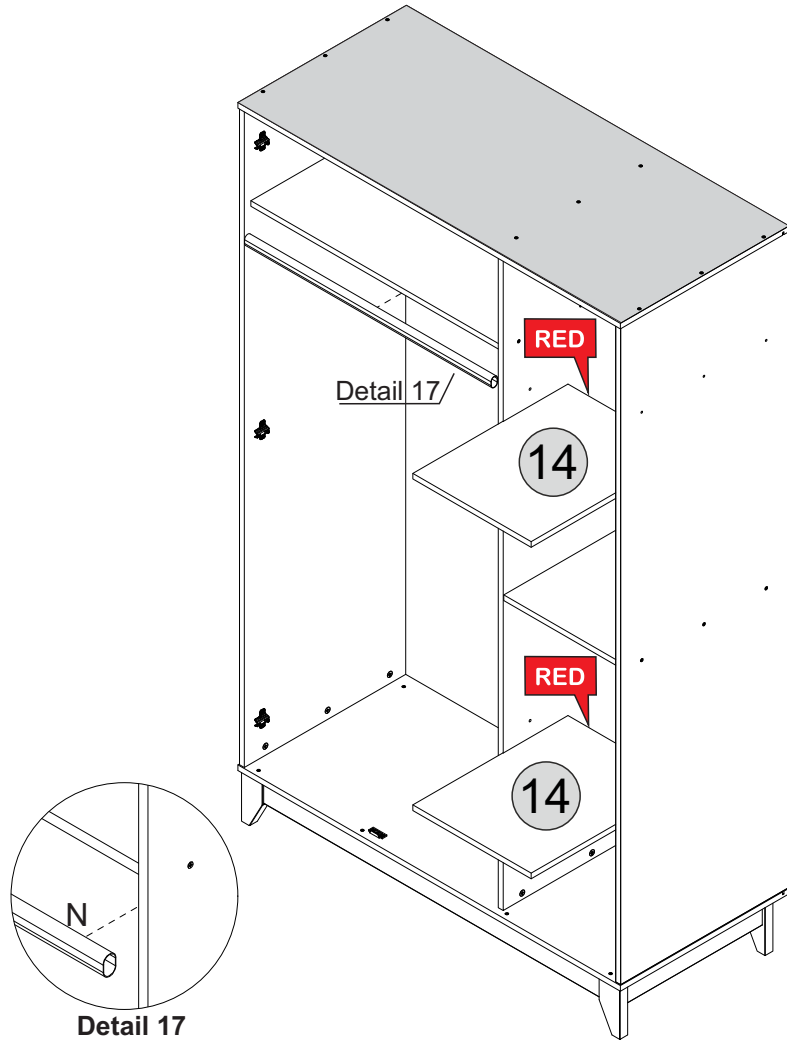

# STEP 27

## PARTS REQUIRED

15 - RIGHT DOOR x2

16 - LEFT DOOR x1

## HARDWARE REQUIRED

F  18  
Ø3,5x14mm

W  09

## TOOLS REQUIRED

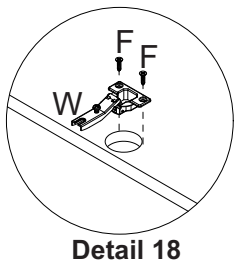
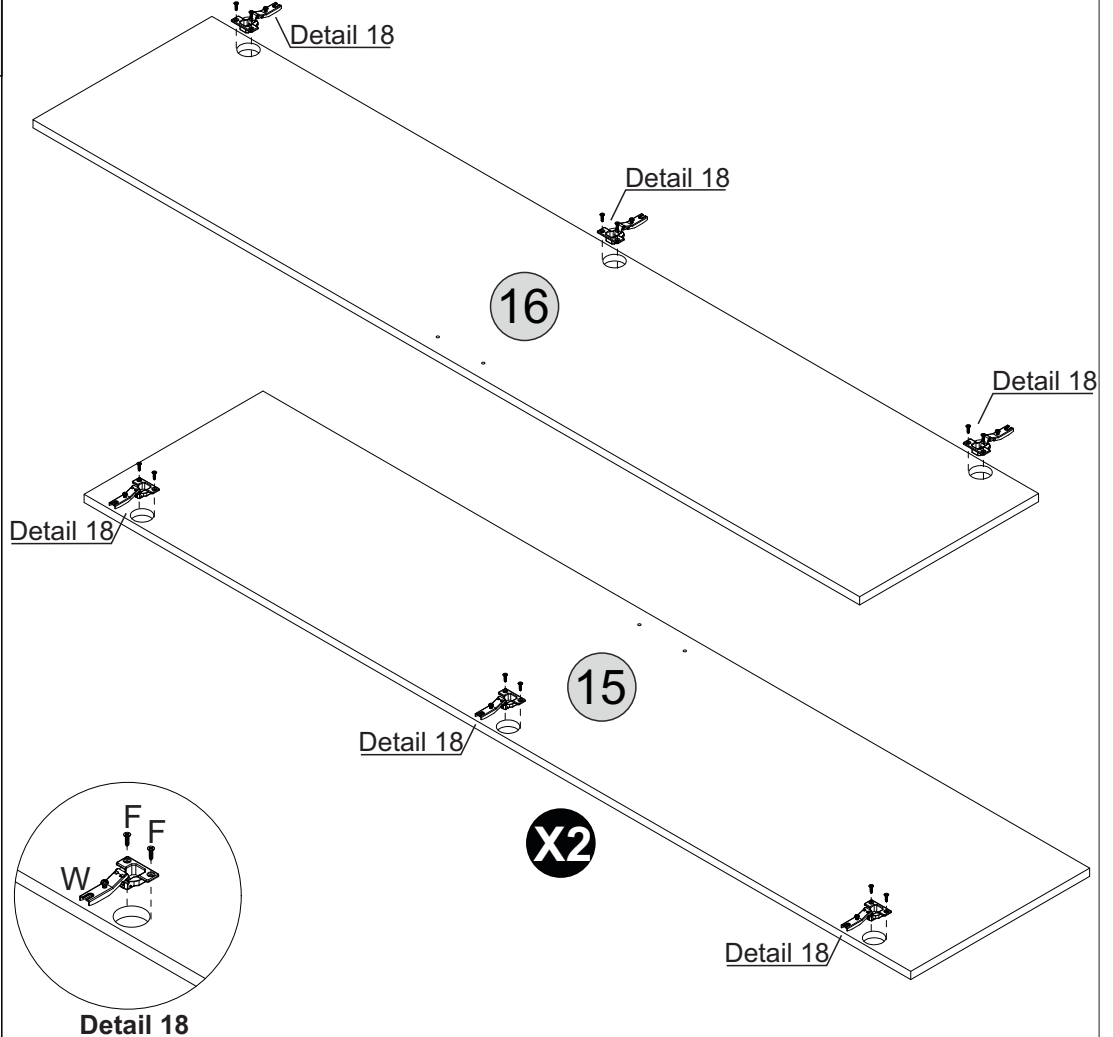
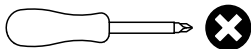

# STEP 28

## PARTS REQUIRED

15 - RIGHT DOOR	x2
-----------------	----

16 - LEFT DOOR	x1
----------------	----

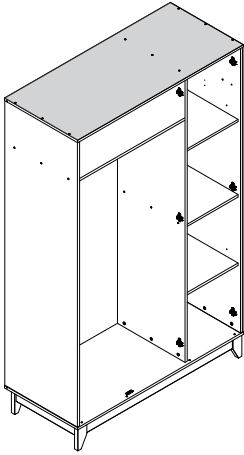

## HARDWARE REQUIRED

D		06
Ø3,5 x 25mm		

I		03
---	---	----

## TOOLS REQUIRED

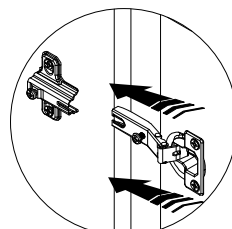
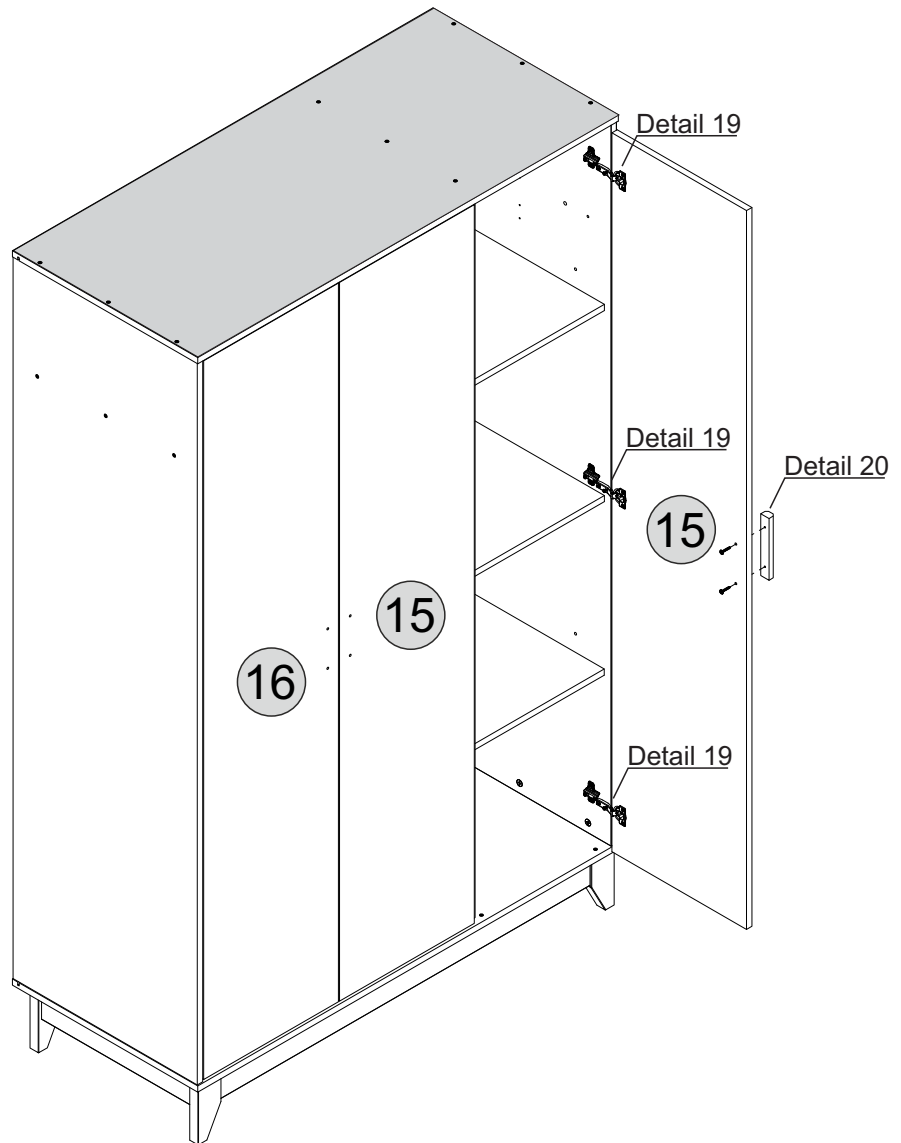
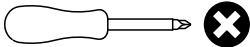

Detail 19

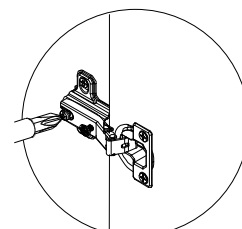

Detail 19

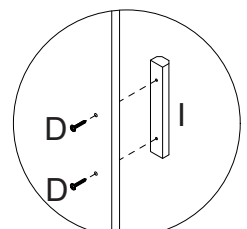



Detail 20

# STEP 29

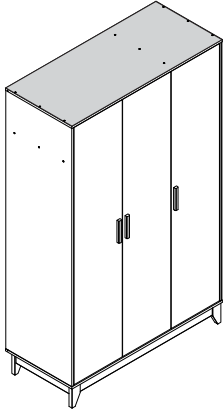
## PARTS REQUIRED



## HARDWARE REQUIRED

D	 Ø3,5 x 25mm	02
O		04
R		02

## TOOLS REQUIRED

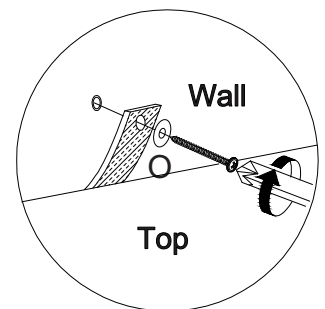
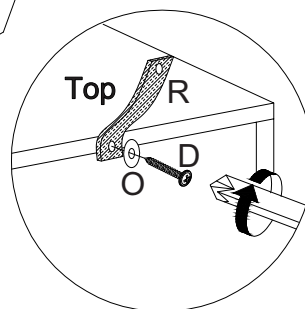
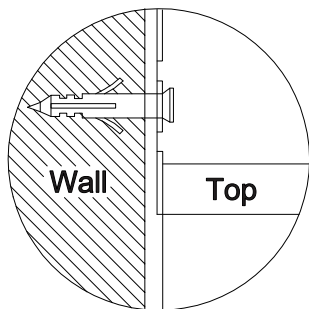
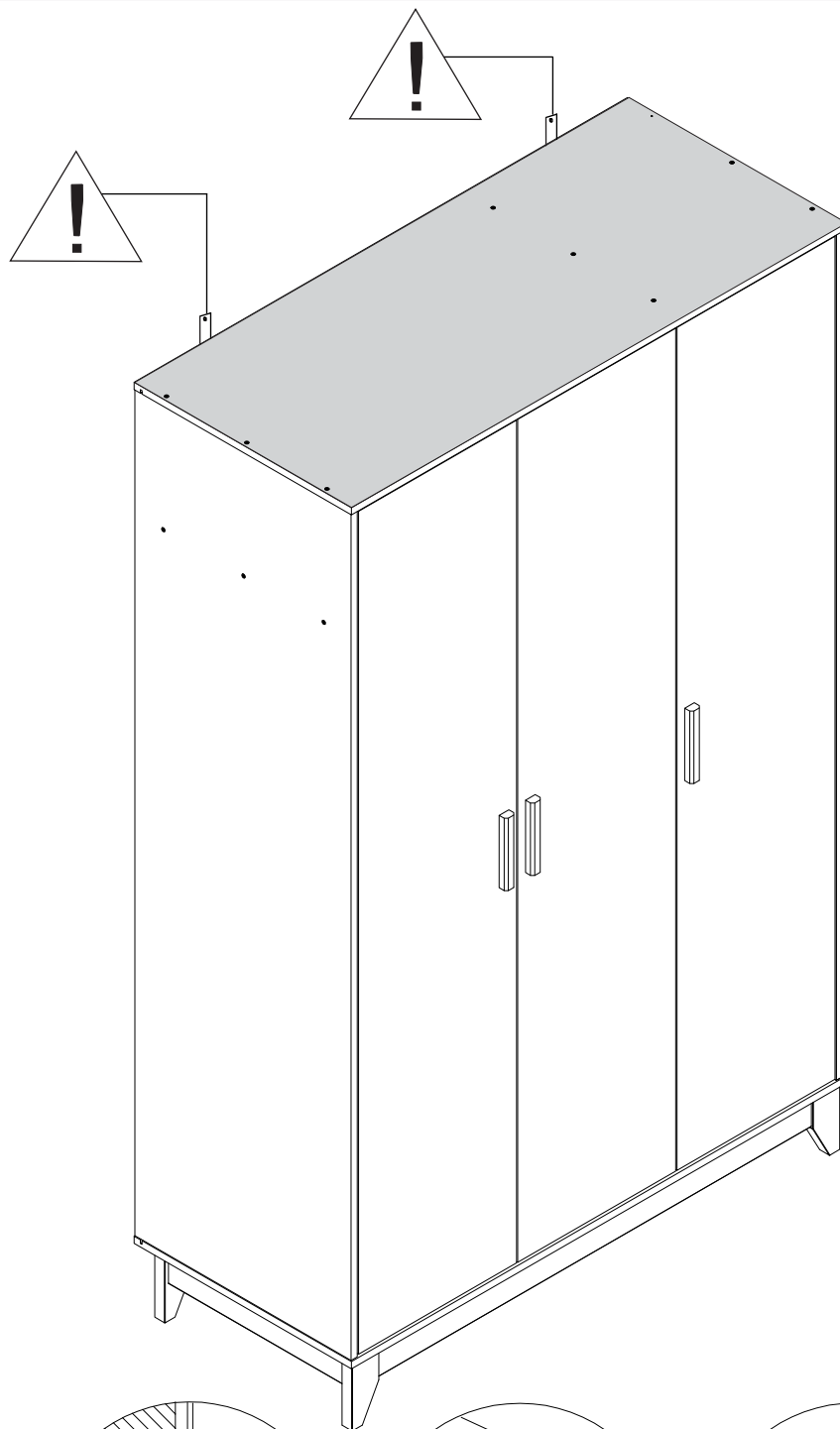
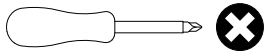

## WARNING

**Serious or fatal injuries can occur from furniture tipping over. To prevent the furniture from tipping over we recommend that it is permanently fixed to the wall.**

Wall fixings are not supplied with this product as different wall materials require different types of fixing devices. Please make sure you use fixings suitable for the walls in your home.