

BLACK WOOD GRAIN LISBON 3 DRAWER CHEST ASSEMBLY INSTRUCTIONS

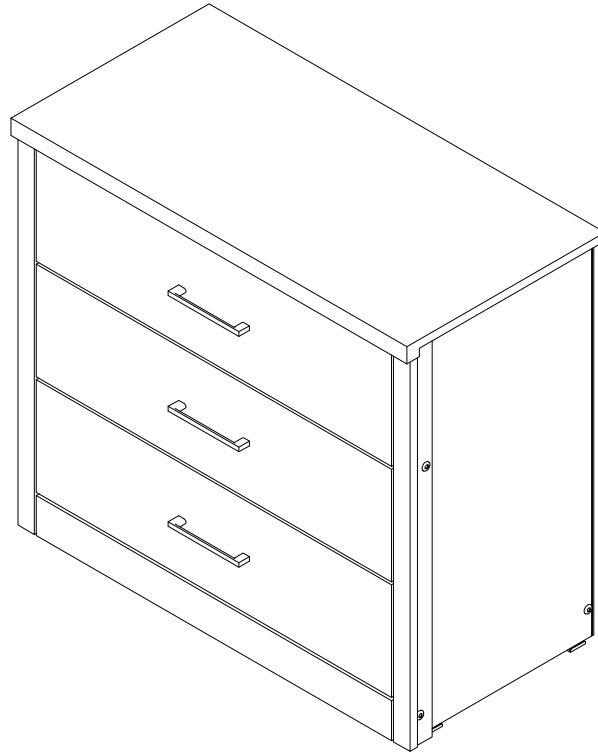
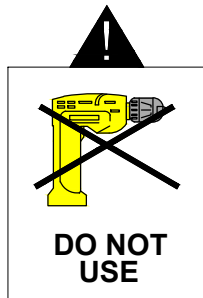

IMPORTANT

PLEASE READ BEFORE YOU CONTINUE FURTHER FOR DOMESTIC USE ONLY

THE PRODUCT YOU HAVE PURCHASED WILL GIVE YOU MANY YEARS OF SERVICE IF YOU FOLLOW THE GUIDELINES FOR ITS SAFE ASSEMBLY AND PERIODIC MAINTENANCE AND CLEANING.

ASSEMBLE ON A SOFT CLEAN SURFACE.

DO NOT USE ANY TOOLS OTHER THAN THOSE SHOWN.

ANY SPANNERS OR ALLEN KEYS REQUIRED ARE INCLUDED WITH THE FITTINGS KIT.

DO NOT FOR ANY REASON USE A POWER TOOL TO ASSEMBLE THIS PRODUCT. ITS USE WILL INVALIDATE ANY CLAIM YOU MAY HAVE AND COULD MAKE THIS PRODUCT UNSAFE.

DEPENDING ON THE AMOUNT OF USE THIS PRODUCT RECEIVES IT MAY BE NECESSARY TO TIGHTEN UP THE FIXINGS FROM TIME TO TIME. THIS IS COMPLETELY NORMAL FOR ANY FLAT PACK FURNITURE. DO NOT OVERTIGHTEN FIXING.

FOR CLEANING, YOU MAY USE A DAMP CLOTH (NOT WET) DO NOT USE POLISH, DETERGENT OR CHEMICAL CLEANERS.



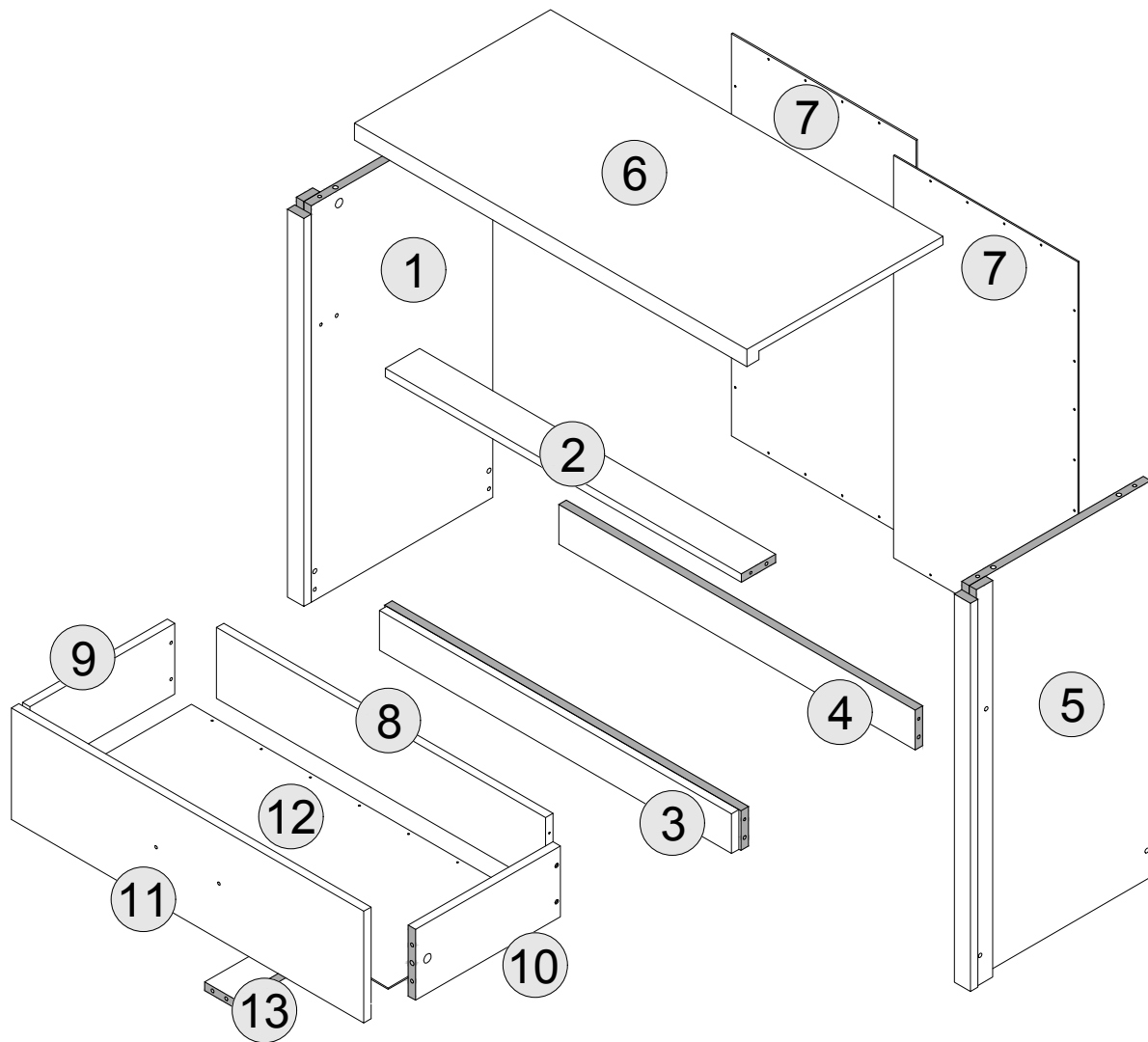









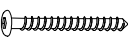

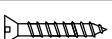
THE SURFACE OF THIS ITEM IS NOT HEAT RESISTANT. ALWAYS USE A PLACE MAT UNDER HOT OR COLD ITEMS TO PREVENT MARKING.

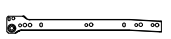
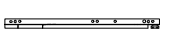
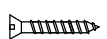

PART LIST

Part Number	Part Code	Part Description	Quantity	Carton
1	S100-102-068-EU1-01	Left Side Panel	1	1/1
2	S100-102-068-EU1-02	Upper Front Crossbar	1	1/1
3	S100-102-068-EU1-03	Base Front Apron	1	1/1
4	S100-102-068-EU1-04	Back Crossbar	1	1/1
5	S100-102-068-EU1-05	Right Side Panel	1	1/1
6	S100-102-068-EU1-06	Top Panel	1	1/1
7	S100-102-068-EU1-07	Back Panel	2	1/1
8	S100-102-068-EU1-08	Drawer Back	3	1/1
9	S100-102-068-EU1-09	Left Side Drawer	3	1/1
10	S100-102-068-EU1-10	Right Side Drawer	3	1/1
11	S100-102-068-EU1-11	Drawer Front	3	1/1
12	S100-102-068-EU1-12	Drawer Base	3	1/1
13	S100-102-068-EU1-13	Drawer Bottom Support Rail	3	1/1

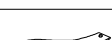
HARDWARE LIST

A		DOWEL 6x30MM	28 PCS
B		BOLT M6x50MM	2 PCS
C		BOLT M7x60MM	4 PCS
D		SCREW M3.5x16MM	22 PCS
E		TACK	43 PCS
F		SCREW M4 X 38MM	12 PCS
G		HANDLE	3 PCS
H		CAM BOLT+CAM NUT	10 SETS
I		PLASTIC H STRIP	1 PC
J		DRAWER RUNNER A (L&R)	6 PCS
K		DRAWER RUNNER B (L&R)	6 PCS
L		SCREW M4 X 30MM	6 PCS
M		HANDLE SCREW 19MM	6 PCS
N		SCREW M3.5x12MM	32 PCS
O		PLASTIC FOOT	4 PCS
P		ALLEN KEY	1 PC
Q		ANTI - TIP STRAP	2 PCS
R		SCREW M4 X 16MM	2 PCS

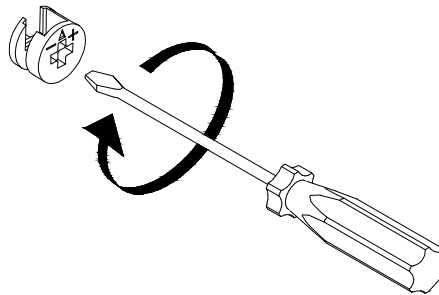

(SCREWDRIVER NOT PROVIDED)

USE A FLAT HEAD SCREWDRIVER TO TIGHTEN THE CAM NUTS. A QUARTER TURN CLOCKWISE IS ALL THAT IS NEEDED.

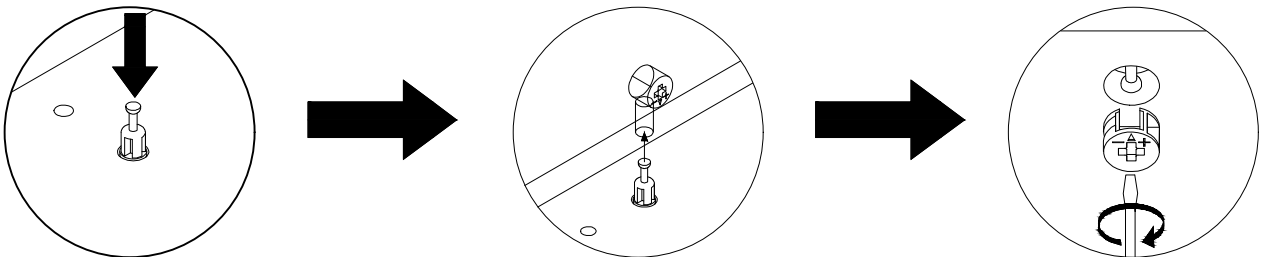

STEP 1 - PUSH CAM BOLT INTO INSERT

STEP 2 - ALIGN THE CAM BOLT WITH THE HOLE AND PUSH TOGETHER UNTIL FLUSH. (MAKE SURE THE ARROW OF THE CAM LOCK IS POINTING TOWARD ON THE EDGE OF THE PANEL.)





STEP 3 - THE HEAD OF THE BOLT GOES INTO THE WIDE MOUTH OF THE CAM LOCK. YOU THEN TURN THE LOCK SO THE NARROW PART CLOSES OVER THE BOLT.

STEP 1

PARTS REQUIRED

1 - LEFT SIDE PANEL	x1
5 - RIGHT SIDE PANEL	x1

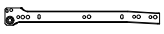
HARDWARE REQUIRED

A		04
H		04
J		06
N		24

TOOLS REQUIRED

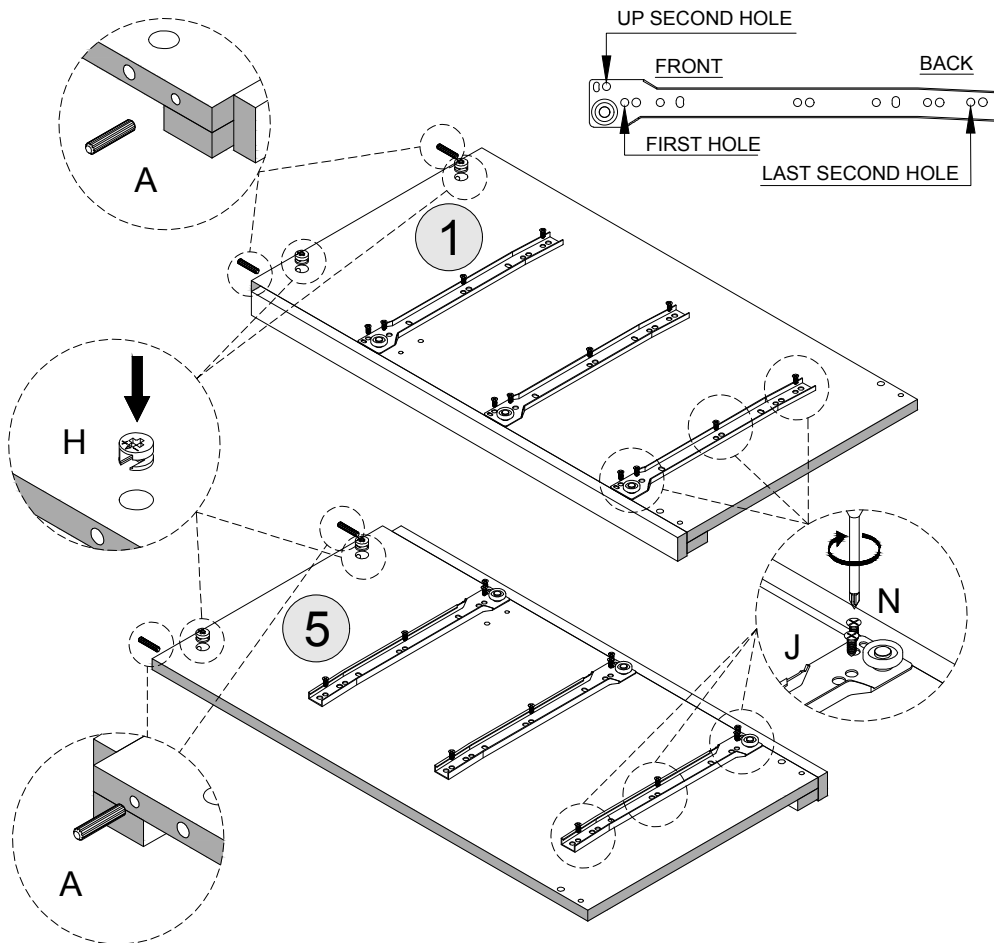
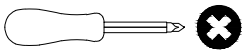



STEP 2

PARTS REQUIRED

2 - UPPER FRONT CROSSBAR	x1
3 - BASE FRONT APRON	x1
4 - BACK CROSSBAR	x1
6 - TOP PANEL	x1

HARDWARE REQUIRED

A		06
H		04

TOOLS REQUIRED

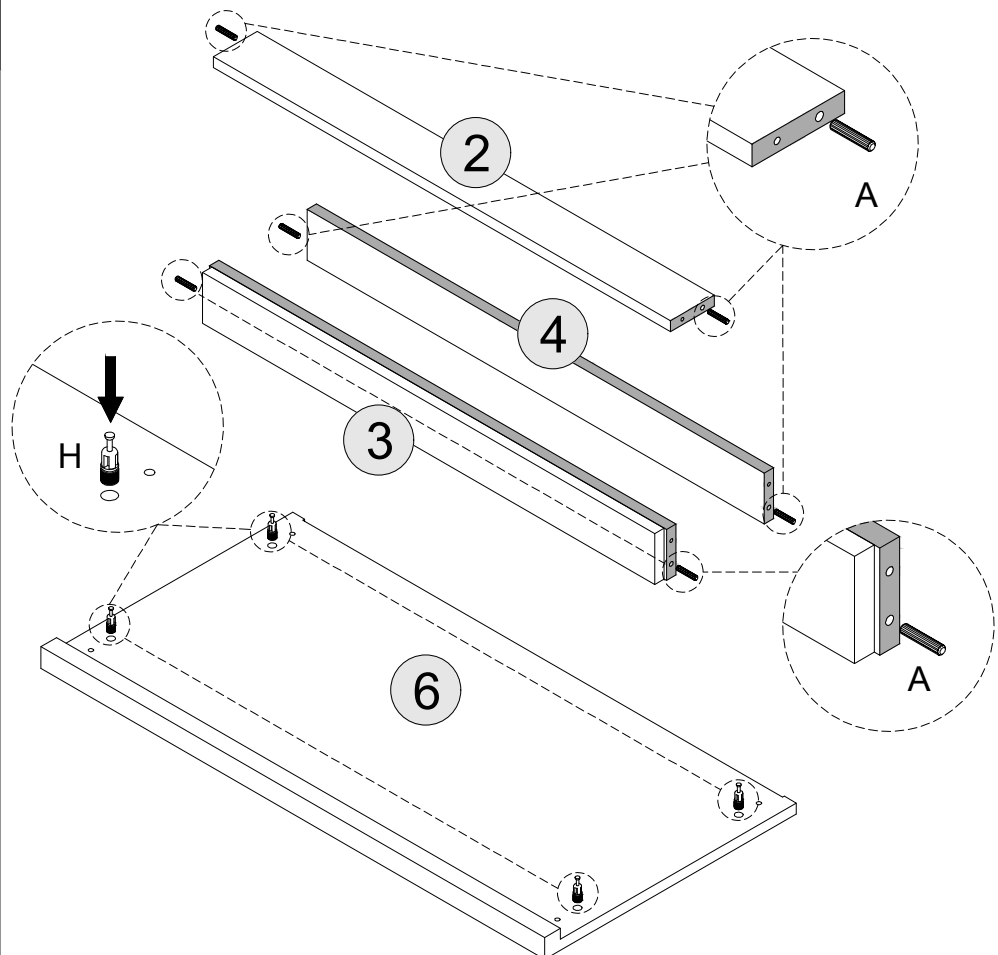

STEP 3

PARTS REQUIRED

1 - LEFT SIDE PANEL	x1
2 - UPPER FRONT CROSSBAR	x1
3 - BASE FRONT APRON	x1
4 - BACK CROSSBAR	x1

HARDWARE REQUIRED

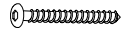
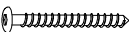
B		01
C		02

TOOLS REQUIRED

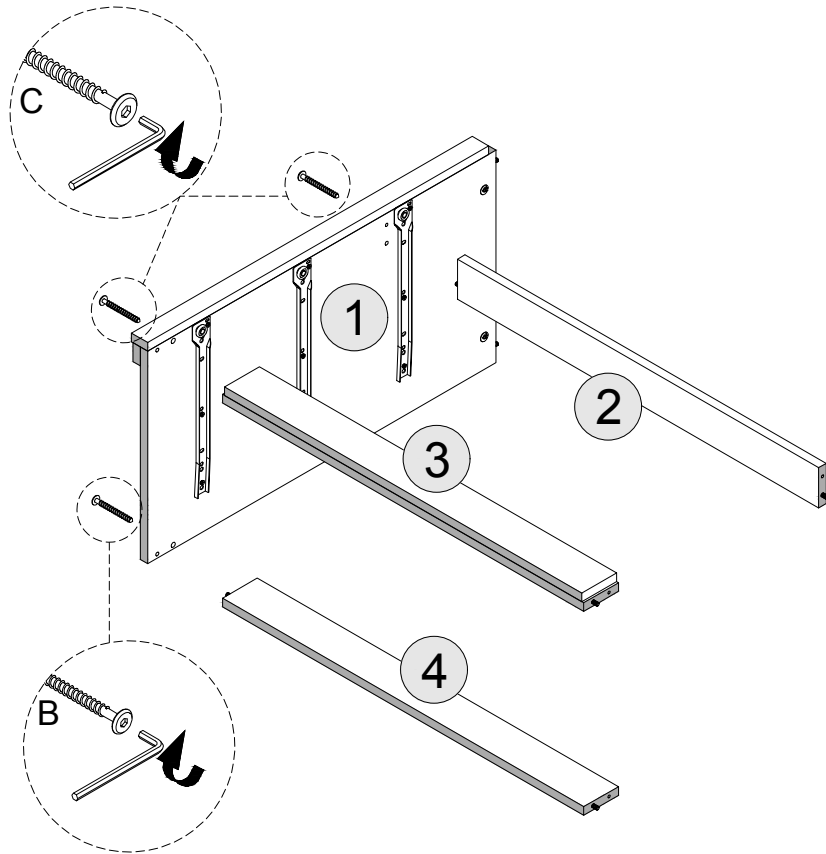
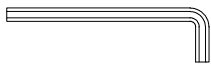

STEP 4

PARTS REQUIRED

2 - UPPER FRONT CROSSBAR	x1
--------------------------	----

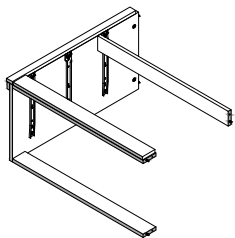

HARDWARE REQUIRED

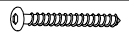
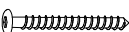
B		01
C		02

TOOLS REQUIRED

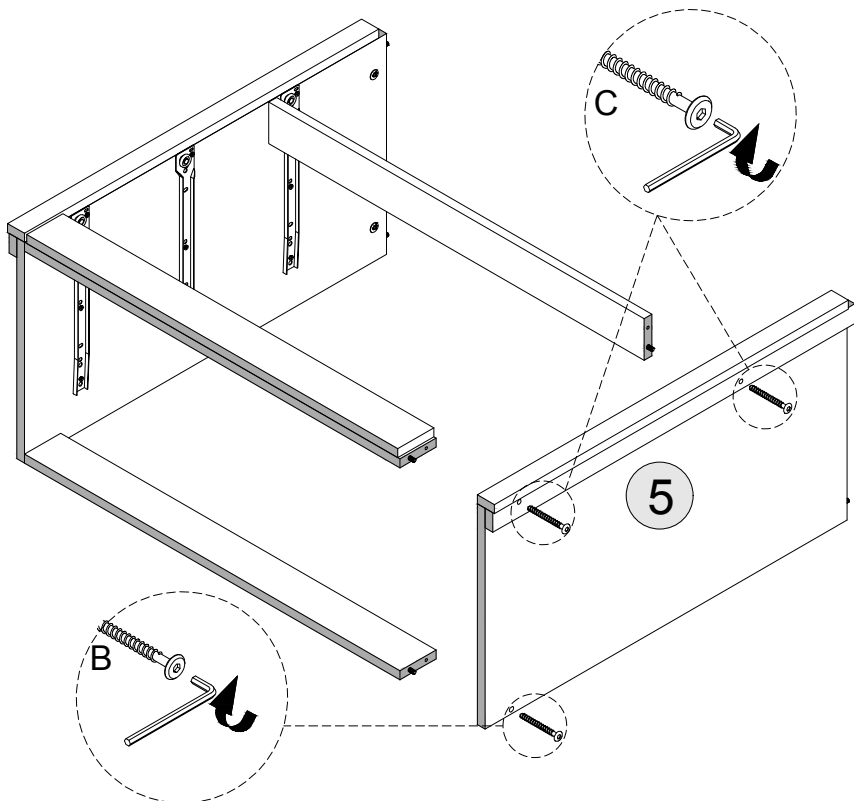

STEP 5

PARTS REQUIRED

6 - TOP PANEL x1

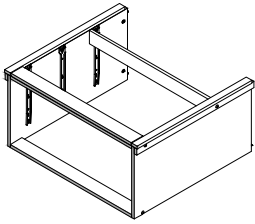

HARDWARE REQUIRED

TOOLS REQUIRED

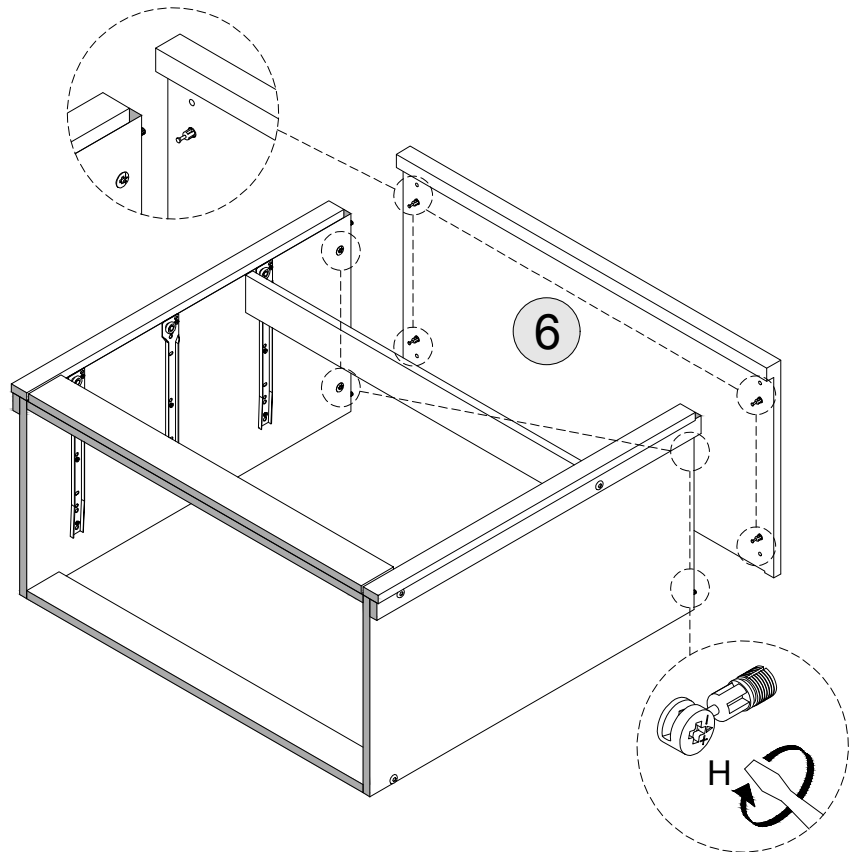
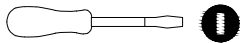

STEP 6

PARTS REQUIRED

7 - BACK PANEL x2

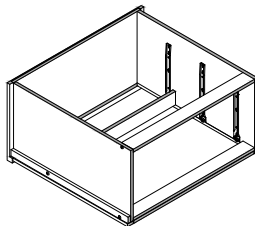

HARDWARE REQUIRED

E  22

I  01

N  08

TOOLS REQUIRED

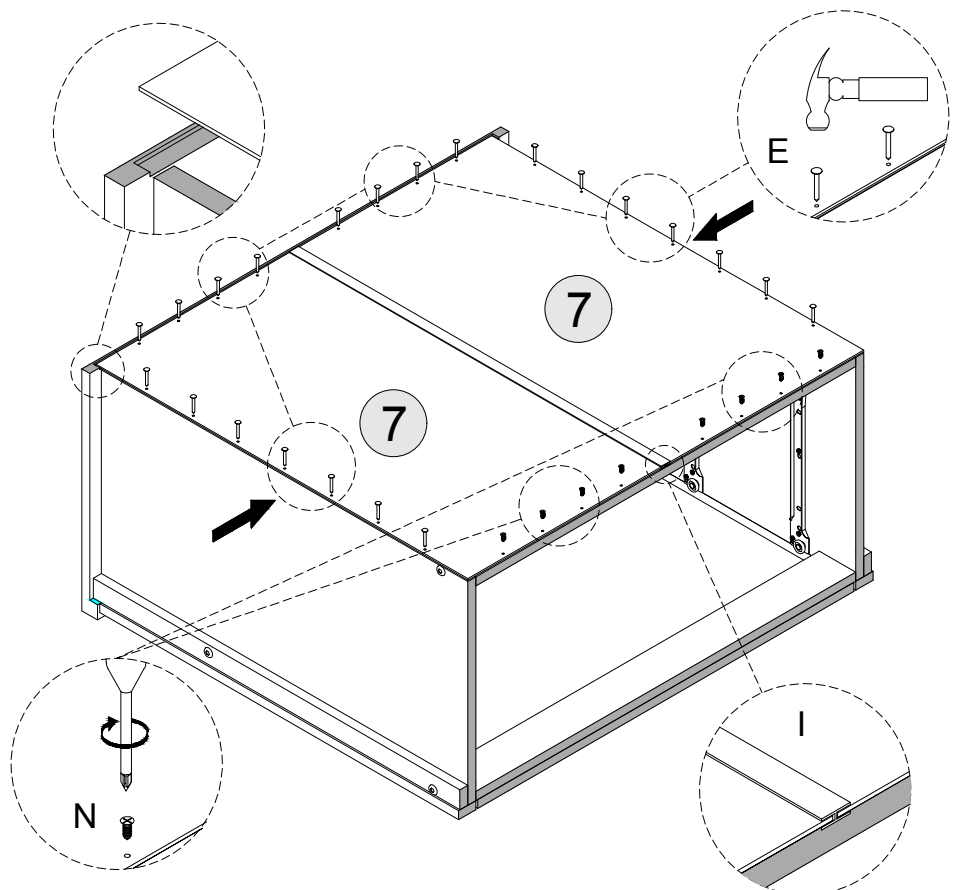
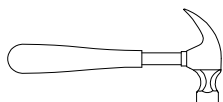
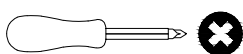

STEP 7

PARTS REQUIRED

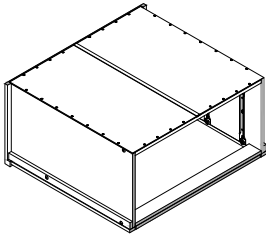

HARDWARE REQUIRED



TOOLS REQUIRED

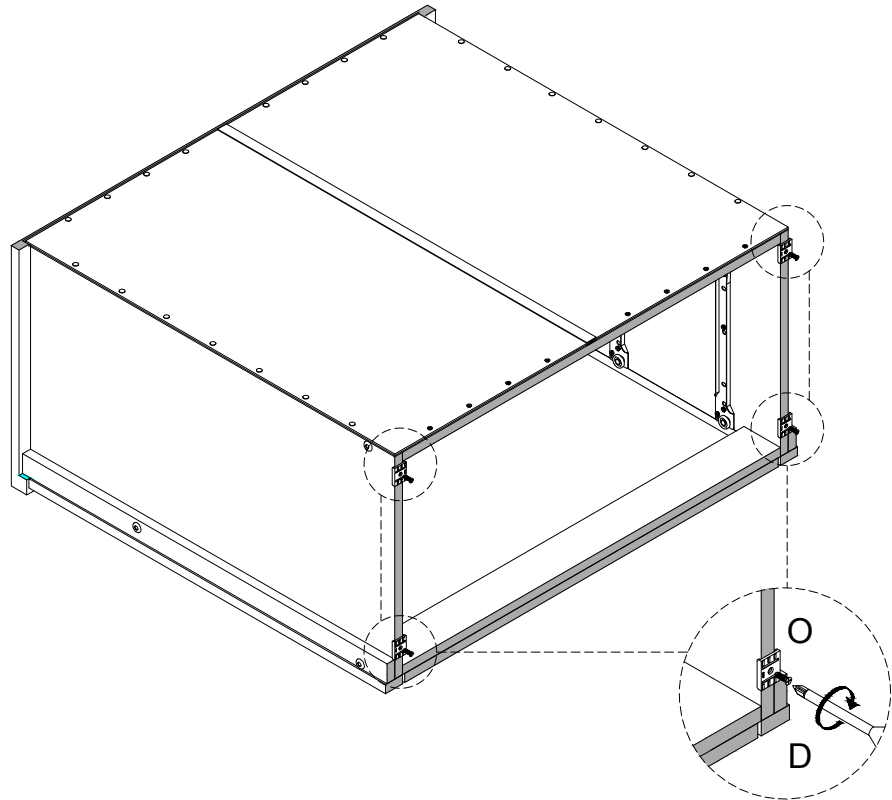

STEP 8

PARTS REQUIRED

8 - DRAWER BACK	x3
-----------------	----

9 - LEFT SIDE DRAWER	x3
----------------------	----

10 - RIGHT SIDE DRAWER	x3
------------------------	----

11 - DRAWER FRONT	x3
-------------------	----

HARDWARE REQUIRED

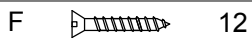

TOOLS REQUIRED

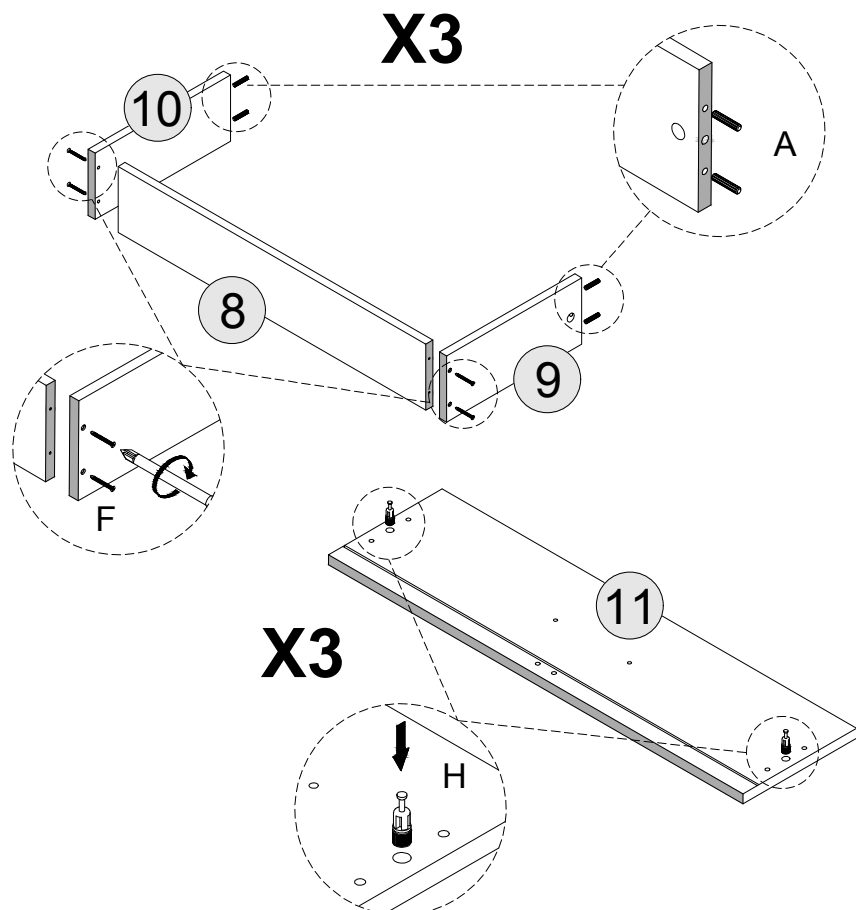
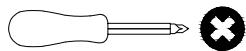

STEP 9

PARTS REQUIRED

11 - DRAWER FRONT x3

12 - DRAWER BASE x3

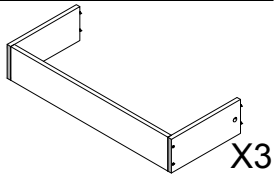

HARDWARE REQUIRED

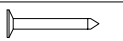
E  21

G  03

H  06

M  06

TOOLS REQUIRED

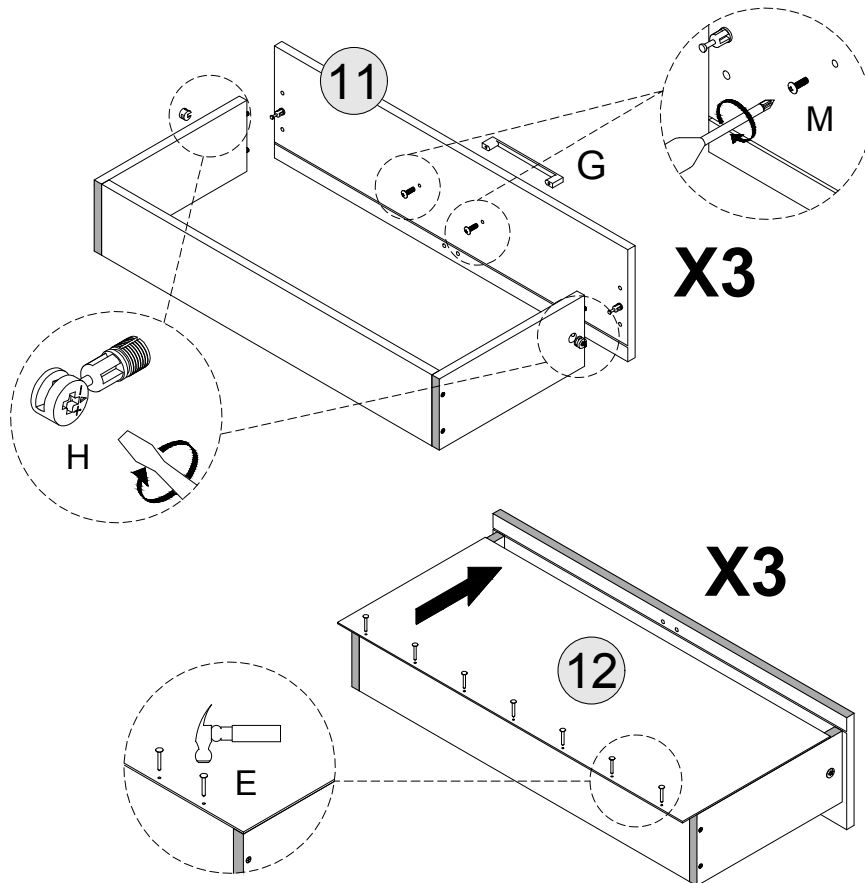
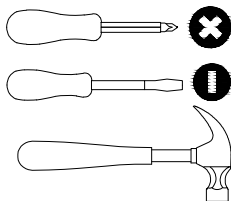

STEP 10

PARTS REQUIRED

13 - DRAWER BOTTOM SUPPORT RAIL x3

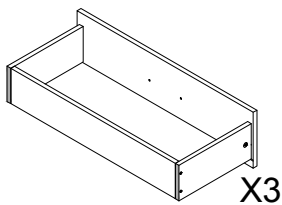

HARDWARE REQUIRED

A  06

D  18

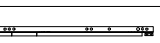
K  06

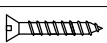
L  06

TOOLS REQUIRED

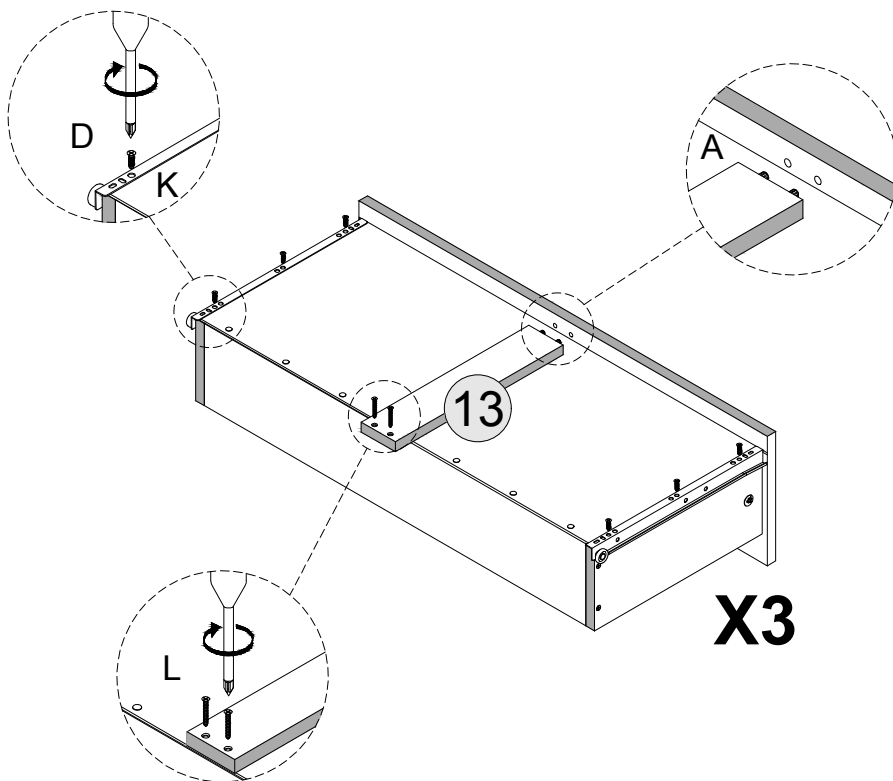
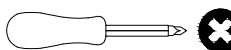

STEP 11

PARTS REQUIRED

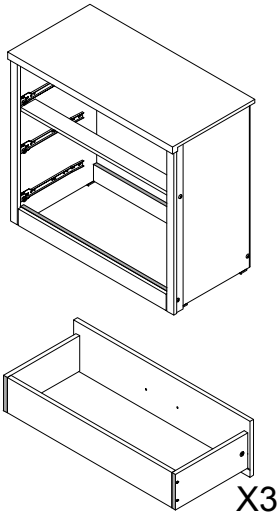

HARDWARE REQUIRED

TOOLS REQUIRED

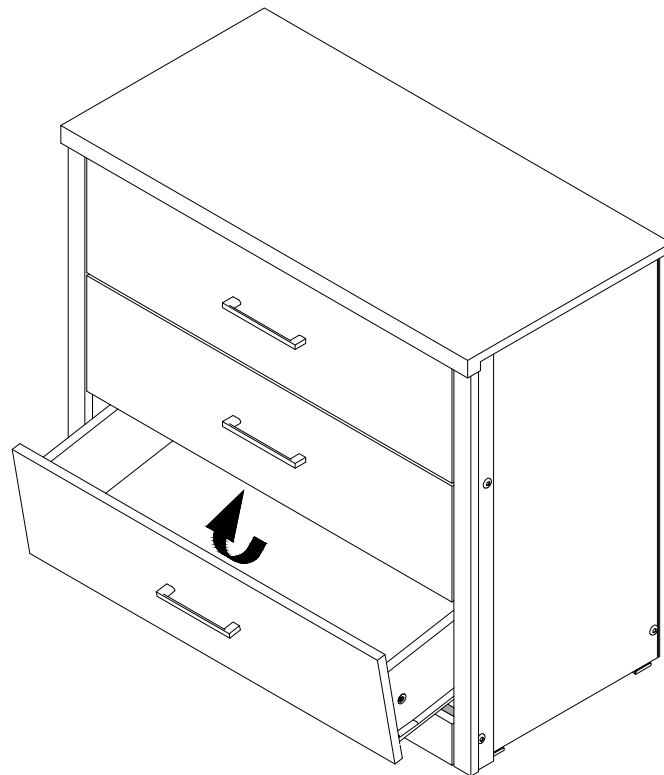

STEP 12

PART REQUIRED

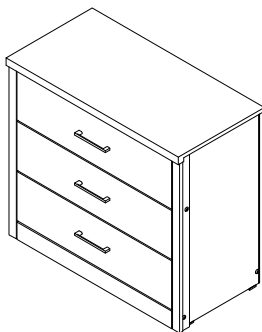

HARDWARE REQUIRED

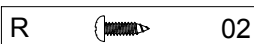

TOOLS REQUIRED

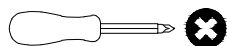

WARNING

Serious or fatal injuries can occur from furniture tipping over. To prevent the furniture from tipping over we recommend that it is permanently fixed to the wall.

Wall fixings are not supplied with this product as different wall materials require different types of fixing devices. Please make sure you use fixings suitable for the walls in your home.

