

BLACK GLOSS SEVILLE 5 DRAWER NARROW CHEST ASSEMBLY INSTRUCTIONS

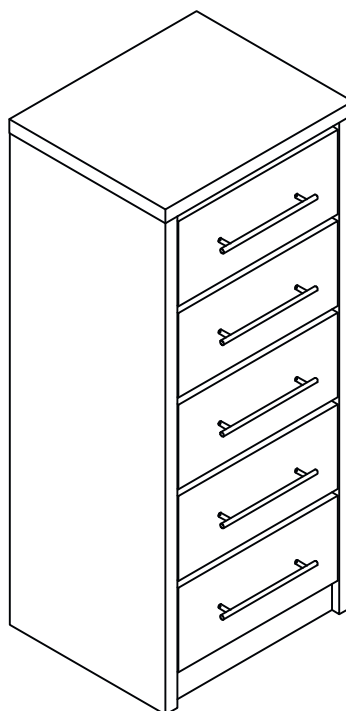

FOR DOMESTIC USE ONLY
IMPORTANT

PLEASE READ BEFORE YOU CONTINUE FURTHER

THE PRODUCT YOU HAVE PURCHASED WILL GIVE YOU MANY YEARS OF SERVICE IF YOU FOLLOW THE GUIDELINES FOR ITS SAFE ASSEMBLY AND PERIODIC MAINTENANCE AND CLEANING.

ASSEMBLE ON A SOFT CLEAN SURFACE.

DO NOT USE ANY TOOLS OTHER THAN THOSE SHOWN.

ANY SPANNERS OR ALLEN KEYS REQUIRED ARE INCLUDED WITH THE FITTING KIT.

DO NOT FOR ANY REASON USE A POWER TOOL TO ASSEMBLE THIS PRODUCT. ITS USE WILL INVALIDATE ANY CLAIM YOU MAY HAVE AND COULD MAKE THIS PRODUCT UNSAFE.

DEPENDING ON THE AMOUNT OF USE THIS PRODUCT RECEIVES, IT MAY BE NECESSARY TO TIGHTEN UP THE FIXINGS FROM TIME TO TIME. THIS IS COMPLETELY NORMAL FOR ANY FLAT PACK FURNITURE. DO NOT OVERTIGHTEN FIXINGS.

FOR CLEANING, YOU MAY USE A DAMP CLOTH (NOT WET). DO NOT USE POLISH, DETERGENT OR CHEMICAL CLEANERS.

THIS SURFACE OF THIS ITEM IS NOT HEAT RESISTANT. ALWAYS USE A PLACE MAT UNDER HOT OR COLD ITEMS TO PREVENT MARKING.





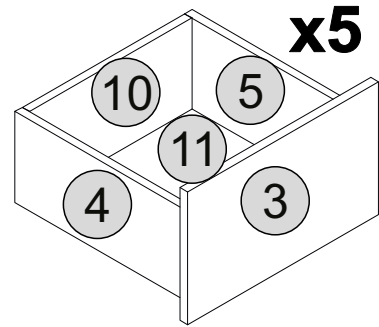
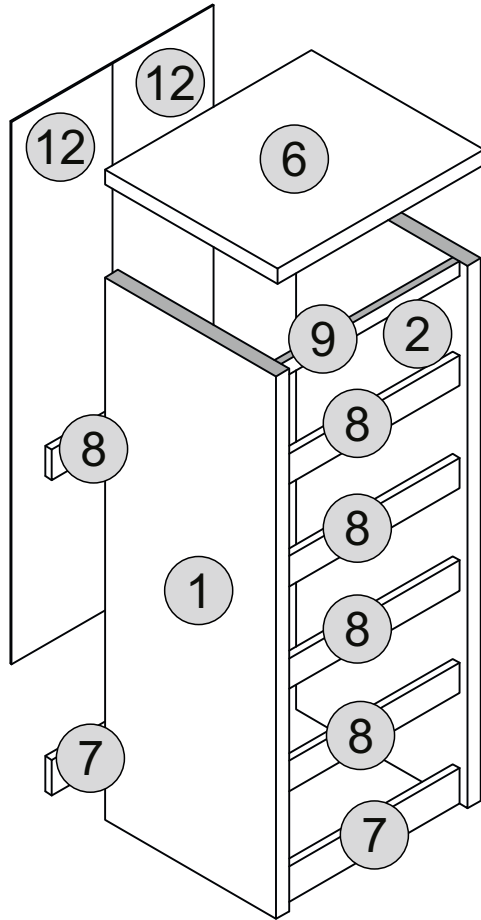







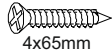

PLEASE NOTE THE CLEAR PROTECTIVE FILM WHICH NEEDS REMOVING FROM THE GLOSS FINISH.



PART LIST

Part Number	Part Code	Part Description	Quantity	Carton
1	S100-102-081-ZF1-01	Left Side Panel	1	1/1
2	S100-102-081-ZF1-02	Right Side Panel	1	1/1
3	S100-102-081-ZF1-03	Drawer Front	5	1/1
4	S100-102-081-ZF1-04	Left Drawer Side	5	1/1
5	S100-102-081-ZF1-05	Right Drawer Side	5	1/1
6	S100-102-081-ZF1-06	Top Panel	1	1/1
7	S100-102-081-ZF1-07	Crossbar	2	1/1
8	S100-102-081-ZF1-08	Support	5	1/1
9	S100-102-081-ZF1-09	Support Panel	1	1/1
10	S100-102-081-ZF1-10	Drawer Back	5	1/1
11	S100-102-081-ZF1-11	Drawer Base	5	1/1
12	S100-102-081-ZF1-12	Back Panel	2	1/1

HARDWARE LIST

No.	Part Name		Qty
A	Wooden Dowel (6x25mm)		x36
B	65mm Screw (4x65mm)		x14
C	14mm Screw (3.5x14mm)		x46
D	38mm Screw (4x38mm)		x20
E	Cam Bolt (8032T)		x14
F	Cam Nut (1512)		x14
G	10" Handle (192mm)		x5
H	20mm Handle Screw		x10
I	14" Drawer Slide		x5
J	PVC L - Bracket		x1
K	Plastic Foot		x4
L	6/8" Nail		x38
M	Wall Fixation (4x20mm=1pc)		x1
N	Screw Cover (Sticker 12mm)		x14

TIPS FOR FITTINGS CAM-LOCKS

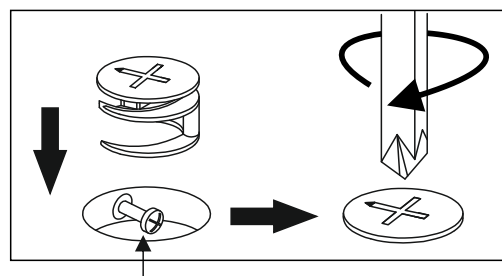
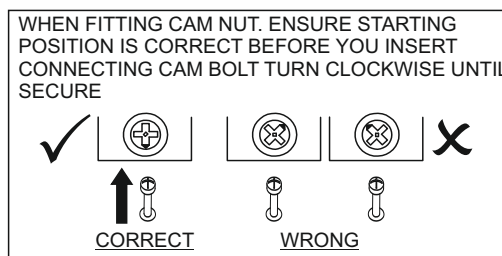

Cam bolt head needs to be in centre

CAMBOLT

Tighten until shoulder in flush with panel. Do not overtighten or undertighten (see example below)

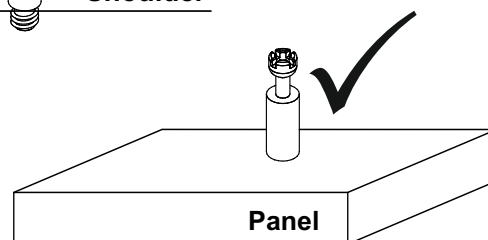
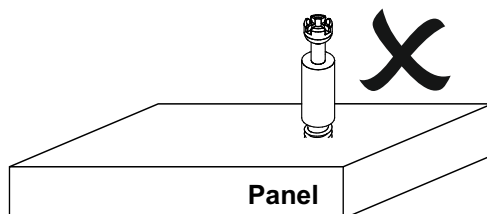
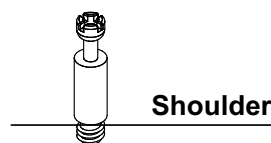

STEP 1

PARTS REQUIRED

1 - LEFT SIDE PANEL x1

2 - RIGHT SIDE PANEL x1

HARDWARE REQUIRED

C  20
3.5x14mm

I  05

K  04

TOOLS REQUIRED

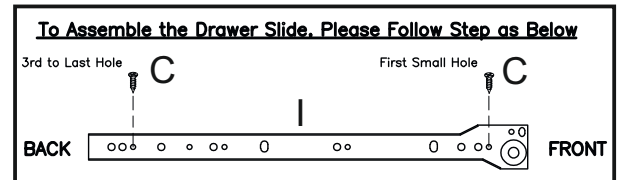
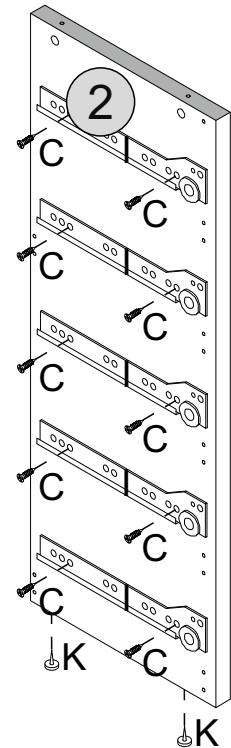
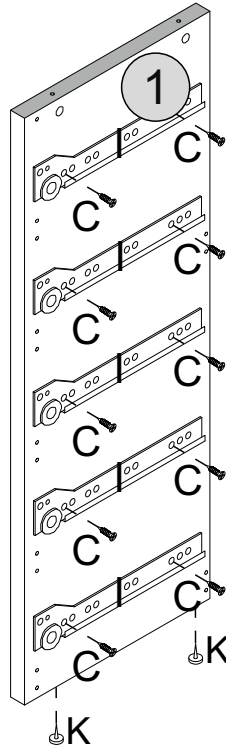
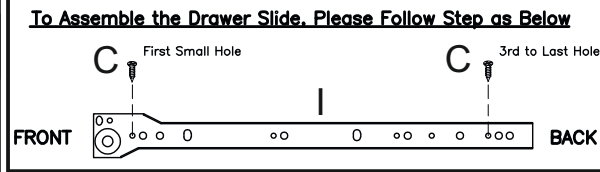
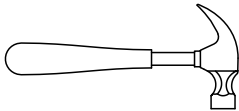
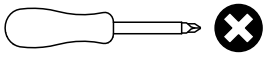



STEP 2

PARTS REQUIRED

6 - TOP PANEL x1

HARDWARE REQUIRED

C  02
3.5x14mm

E  04

J  01

TOOLS REQUIRED

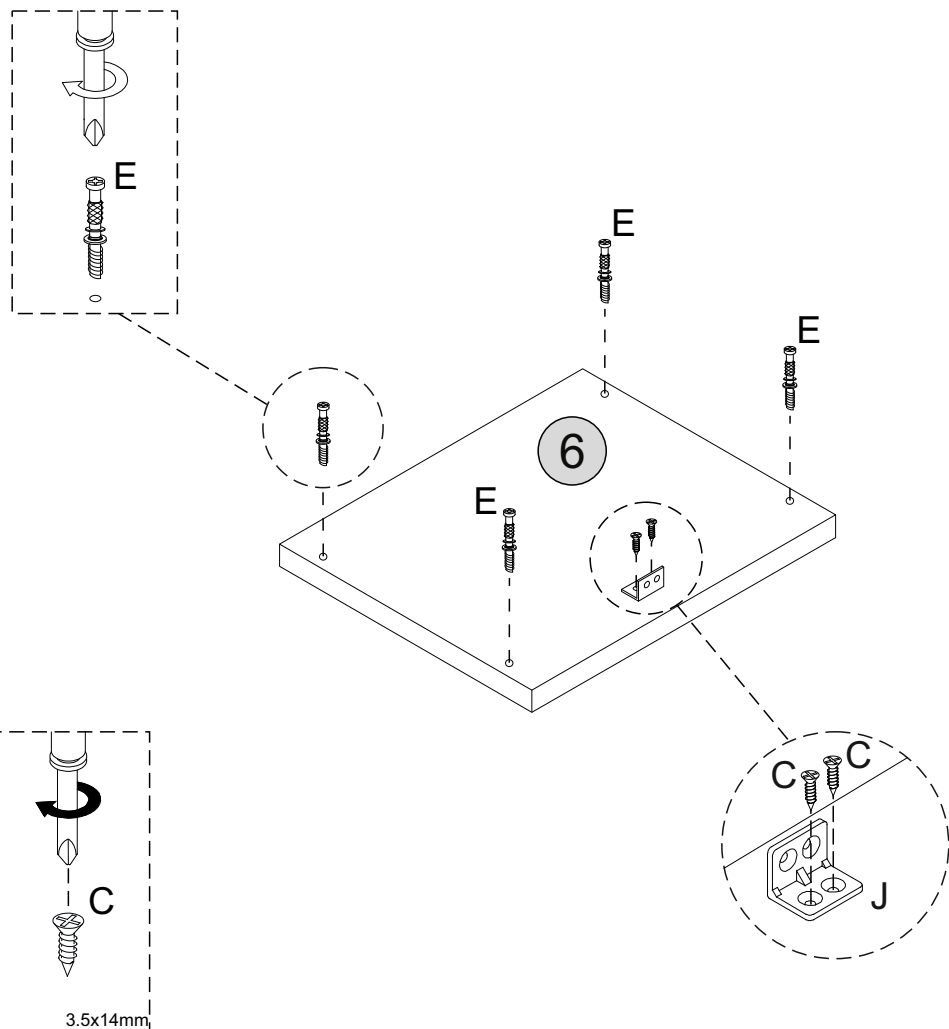
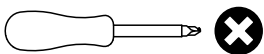

STEP 3

PARTS REQUIRED

7 - CROSSBAR	x2
8 - SUPPORT	x5
9 - SUPPORT PANEL	x1

HARDWARE REQUIRED

A		16
---	---	----

TOOLS REQUIRED

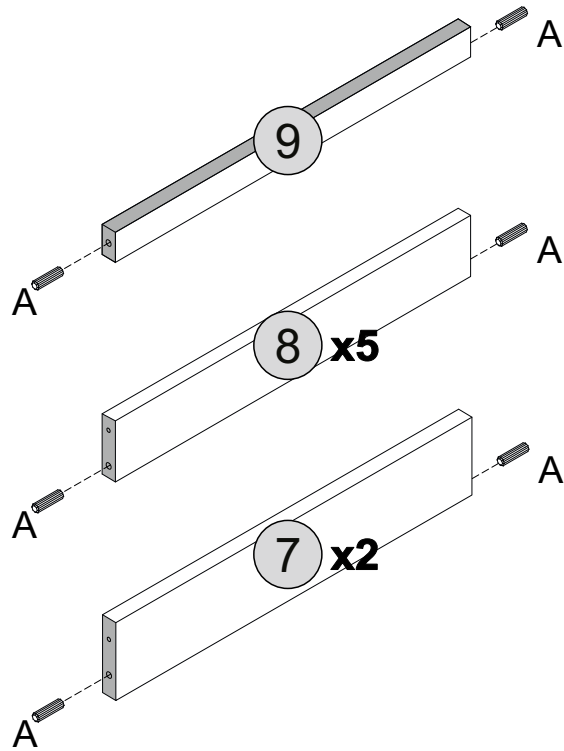
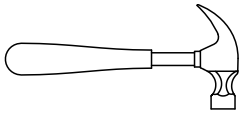

STEP 4

PARTS REQUIRED

2 - RIGHT SIDE PANEL	x1
7 - CROSSBAR	x2
8 - SUPPORT	x5

HARDWARE REQUIRED

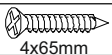
B		07
---	---	----

TOOLS REQUIRED

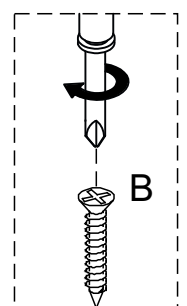
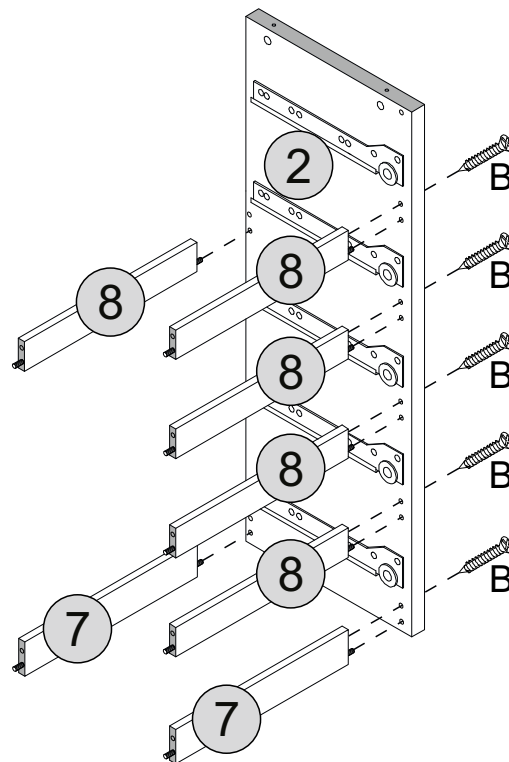
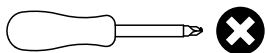

STEP 5

PARTS REQUIRED

1 - LEFT SIDE PANEL x1

9 - SUPPORT PANEL x1

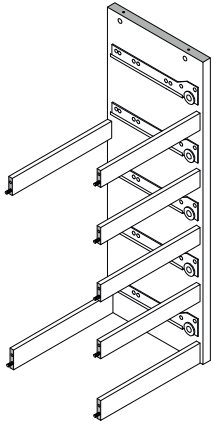

HARDWARE REQUIRED

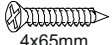
B  07
4x65mm

TOOLS REQUIRED

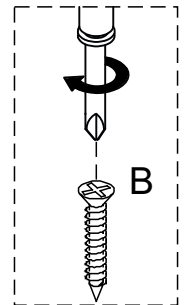
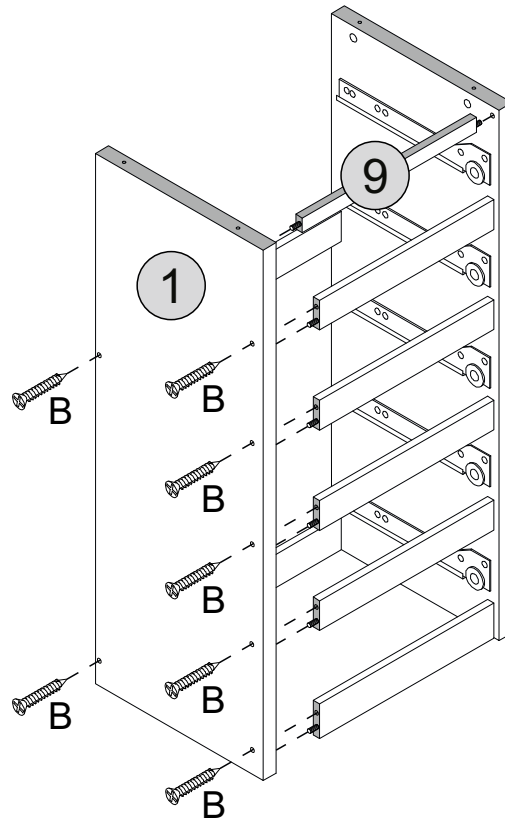
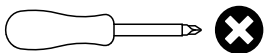

STEP 6

PARTS REQUIRED

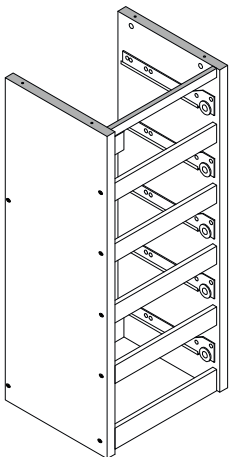

HARDWARE REQUIRED

F  04

N  14

TOOLS REQUIRED

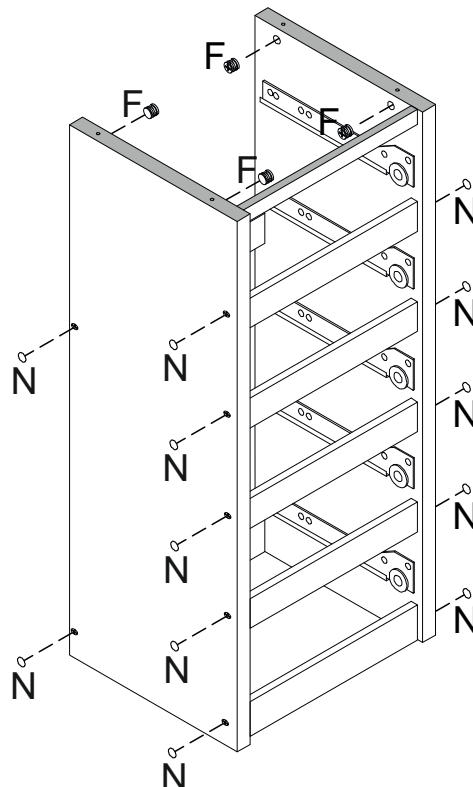

STEP 7

PARTS REQUIRED

6 - TOP PANEL x1

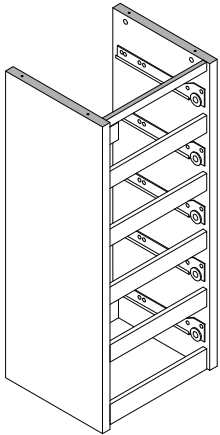

HARDWARE REQUIRED

C 3.5x14mm 02

TOOLS REQUIRED

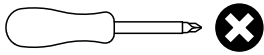

When Fitting Cams
Ensure the starting position is correct before you insert the connecting bolt, turn clockwise until secure.

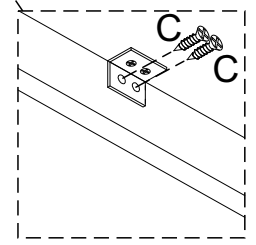
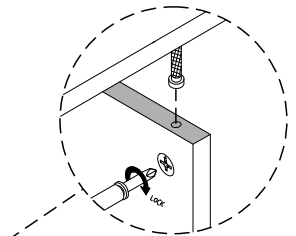
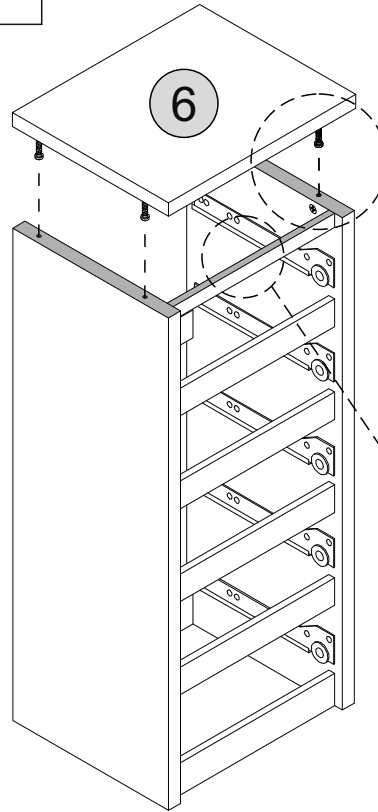
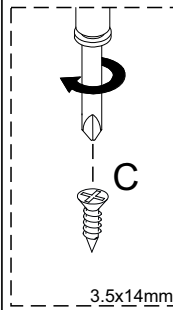

STEP 8

PARTS REQUIRED

12 - BACK PANEL x2

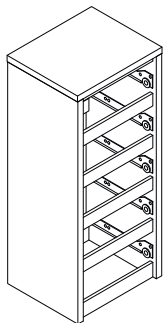

HARDWARE REQUIRED

C 3.5x14mm 02

L 28

TOOLS REQUIRED

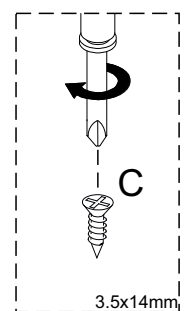
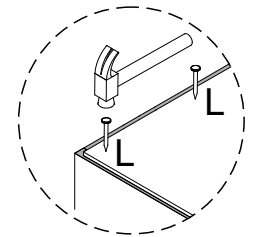
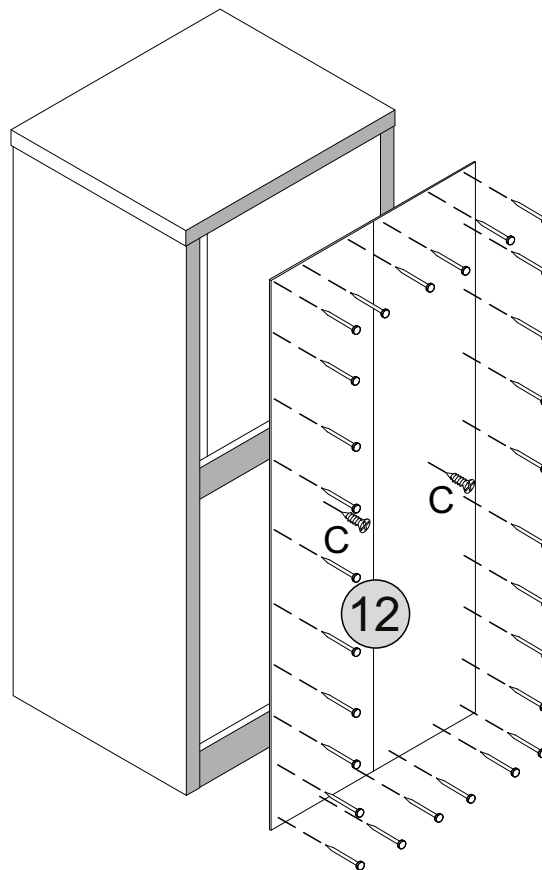
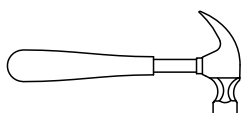
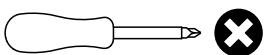



STEP 9

PARTS REQUIRED

3 - DRAWER FRONT	x5
4 - LEFT DRAWER SIDE	x5
5 - RIGHT DRAWER SIDE	x5

HARDWARE REQUIRED

A		20
E		10
F		10

TOOLS REQUIRED

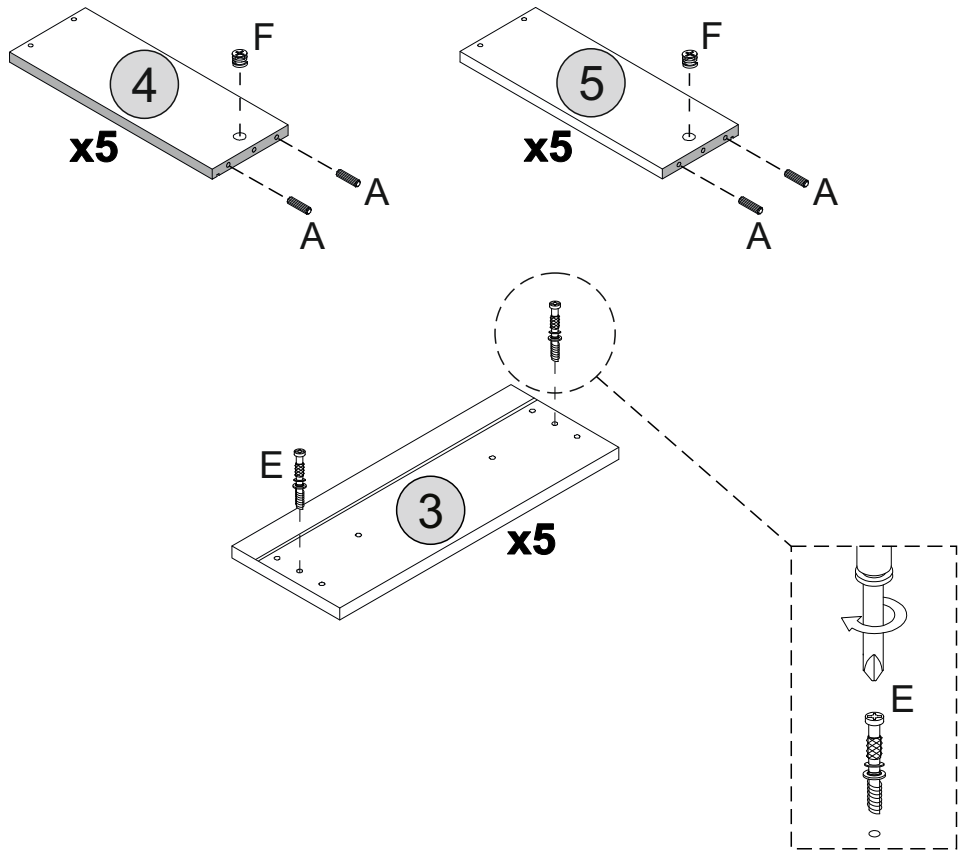
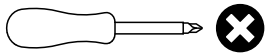

STEP 10

PARTS REQUIRED

4 - LEFT DRAWER SIDE	x5
5 - RIGHT DRAWER SIDE	x5
10- DRAWER BACK	x5

HARDWARE REQUIRED

D	 4x38mm	20
---	--	----

TOOLS REQUIRED

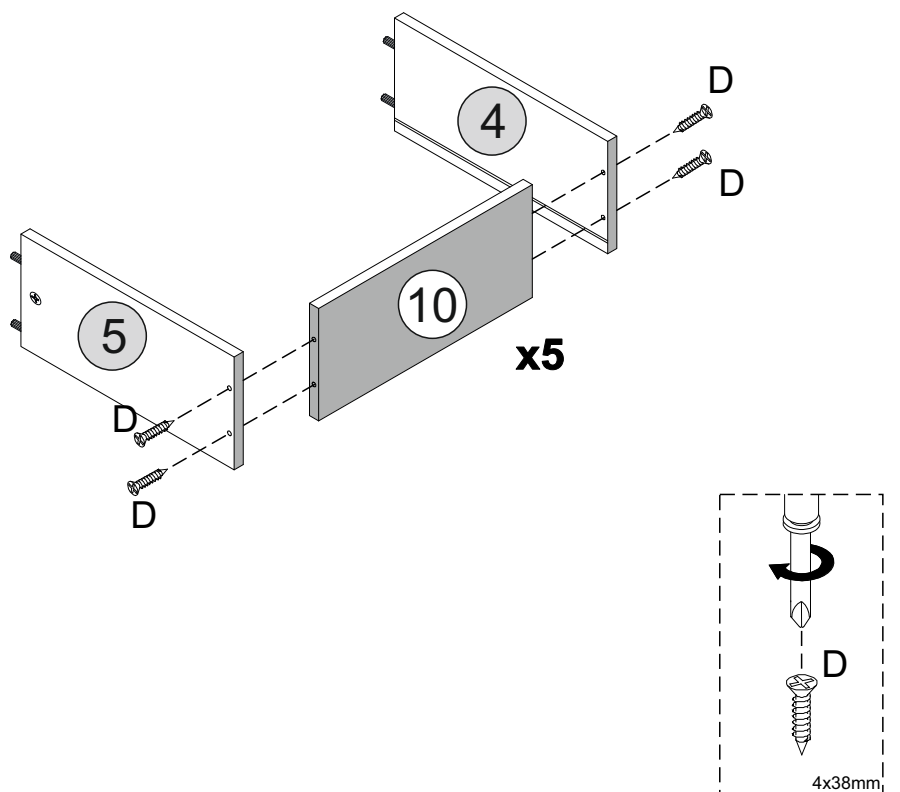
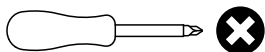

STEP 11

PARTS REQUIRED

11- DRAWER BASE x5

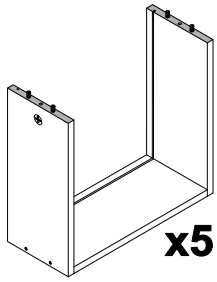

HARDWARE REQUIRED

TOOLS REQUIRED

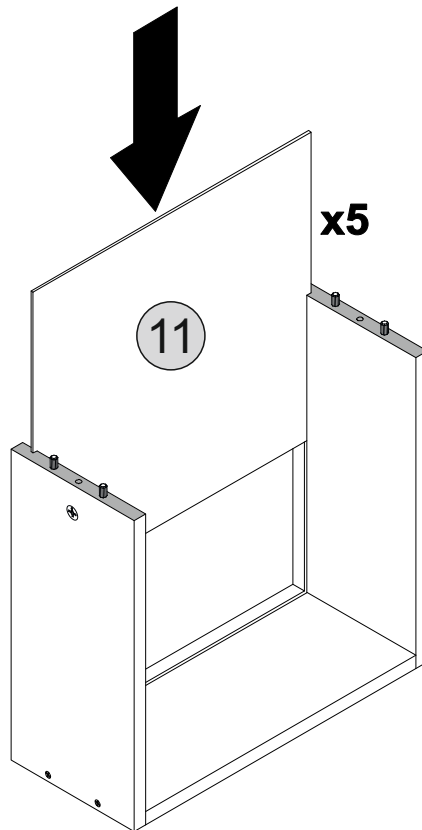

STEP 12

PARTS REQUIRED

3 - DRAWER FRONT x5

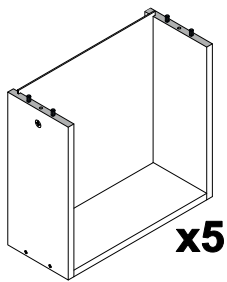

HARDWARE REQUIRED

TOOLS REQUIRED

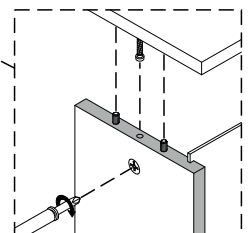
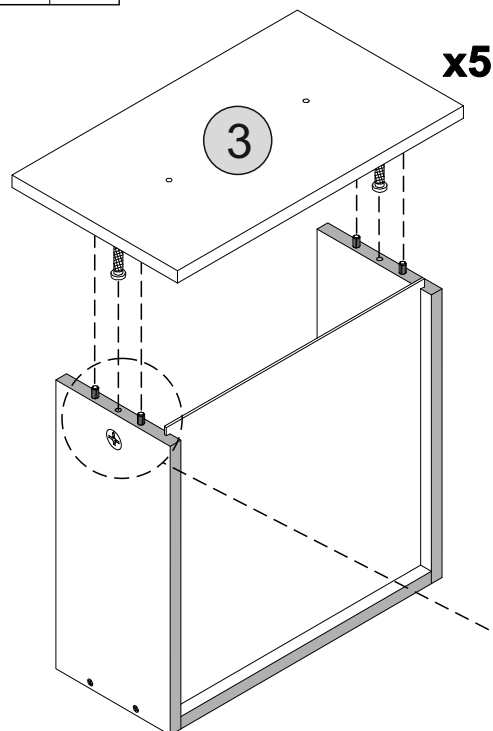
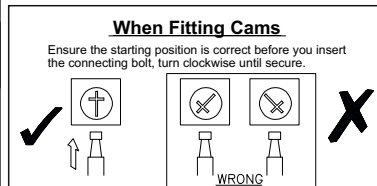
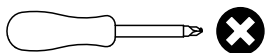

STEP 13

PARTS REQUIRED

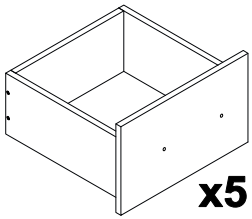

HARDWARE REQUIRED

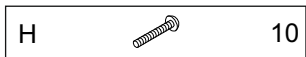
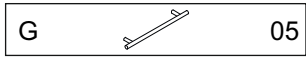

TOOLS REQUIRED

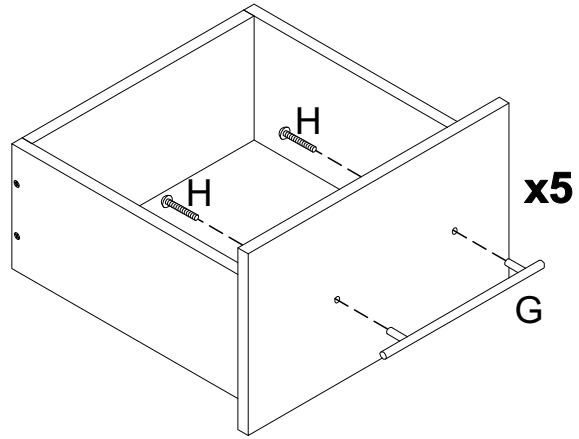
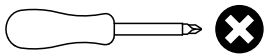

STEP 14

PARTS REQUIRED

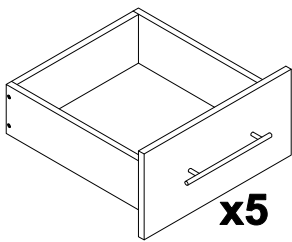

HARDWARE REQUIRED

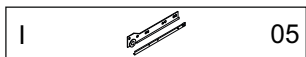
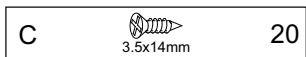

TOOLS REQUIRED

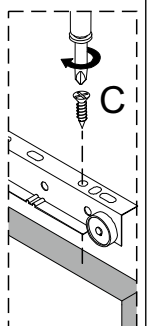
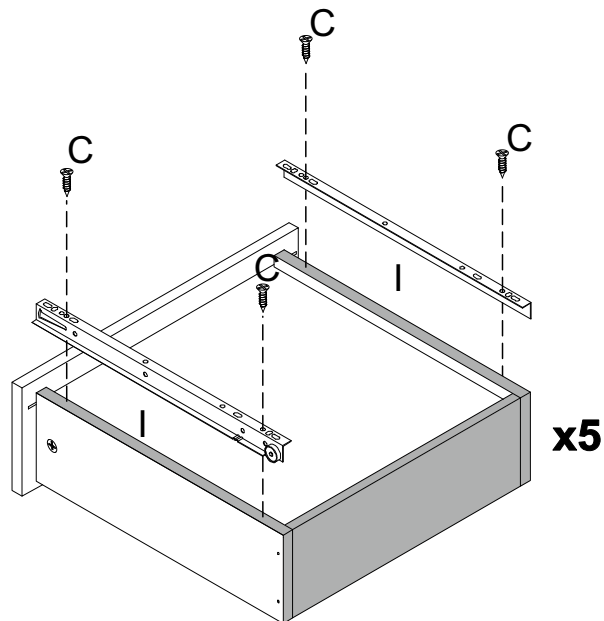
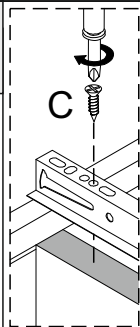
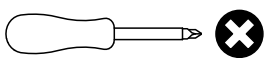

STEP 15

PARTS REQUIRED

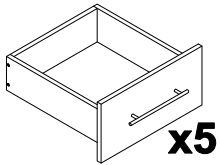
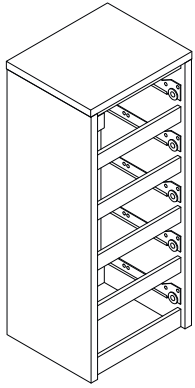

HARDWARE REQUIRED

TOOLS REQUIRED

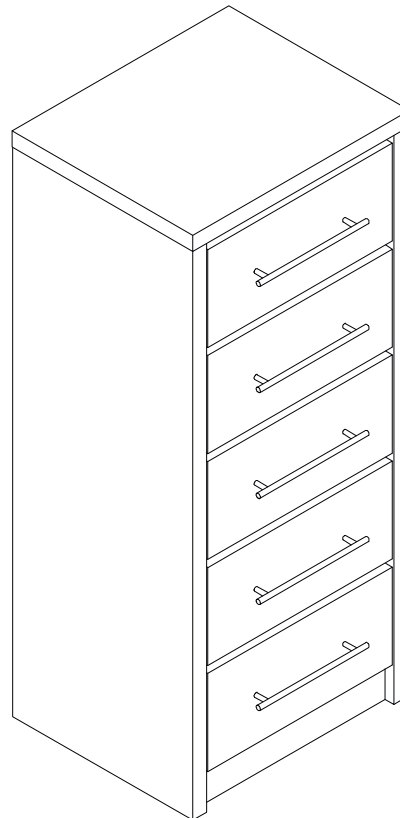

PLEASE NOTE THE CLEAR PROTECTIVE FILM WHICH NEEDS REMOVING FROM THE GLOSS FINISH.

STEP 16

WARNING

Serious or fatal injuries can occur from furniture tipping over. To prevent the furniture from tipping over we recommend that it is permanently fixed to the wall.

Wall fixings are not supplied with this product as different wall materials require different types of fixing devices. Please make sure you use fixings suitable for the walls in your home.

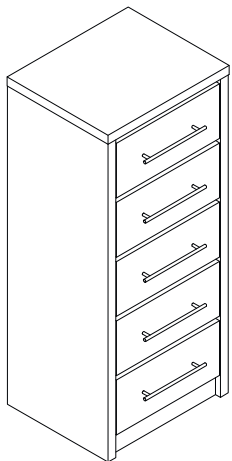

HARDWARE REQUIRED



TOOLS REQUIRED

