

NEVADA 3 DRAWER CHEST ASSEMBLY INSTRUCTIONS

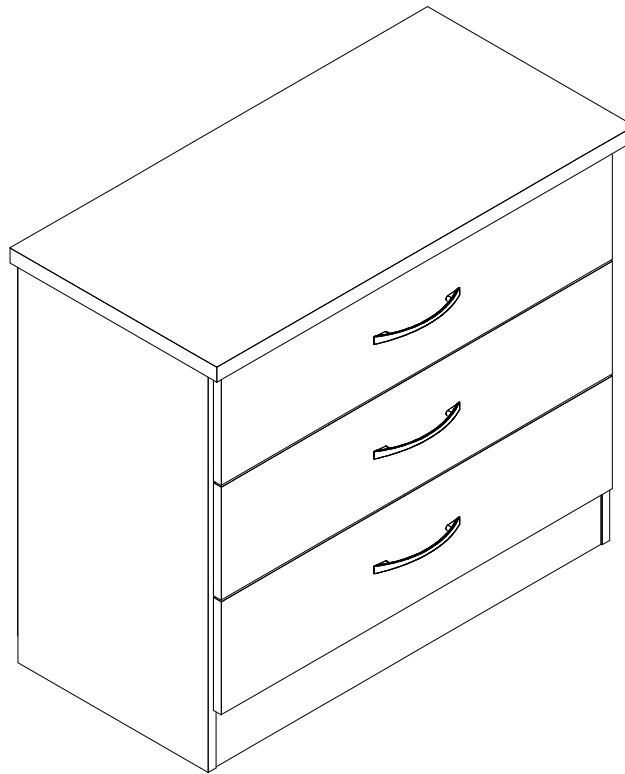

IMPORTANT FOR DOMESTIC USE ONLY

PLEASE READ BEFORE YOU CONTINUE FURTHER

CARE AND MAINTENANCE

After unpacking this product please keep the original packaging in case it needs to be returned for any reason.

- Please ensure all fittings and parts are present before commencing with assembly.
- Never drag or push products as this could cause damage to the joints making it inferior.
- We strongly recommend that you keep children away from your work area.
- We recommend that you lay a blanket or sheet on the floor to avoid damage to both your floor and the product.
- Assemble this product as close to its final position as possible.
- Do not place this product next to a radiator or in direct sunlight.
- Do not drag or push items across your high gloss furniture as this may cause the surface to scratch
- Wood is a natural product and may expand if subjected to damp and may shrink or crack if subjected to heat. Therefore it is recommended that room temperature is maintained, with no sudden temperature fluctuations.
- Make sure any spillage is wiped off immediately.
- Do not place hot or chilled items directly on to the surface, use a place mat or marking will occur.
- For general cleaning use a soft cotton or micro fibre cloth, and do not use detergents of any kind.
- From time to time it may be necessary to tighten fittings, regular inspections should be carried out.
- Do not place on a wet or damp floor as staining may occur to your floor.

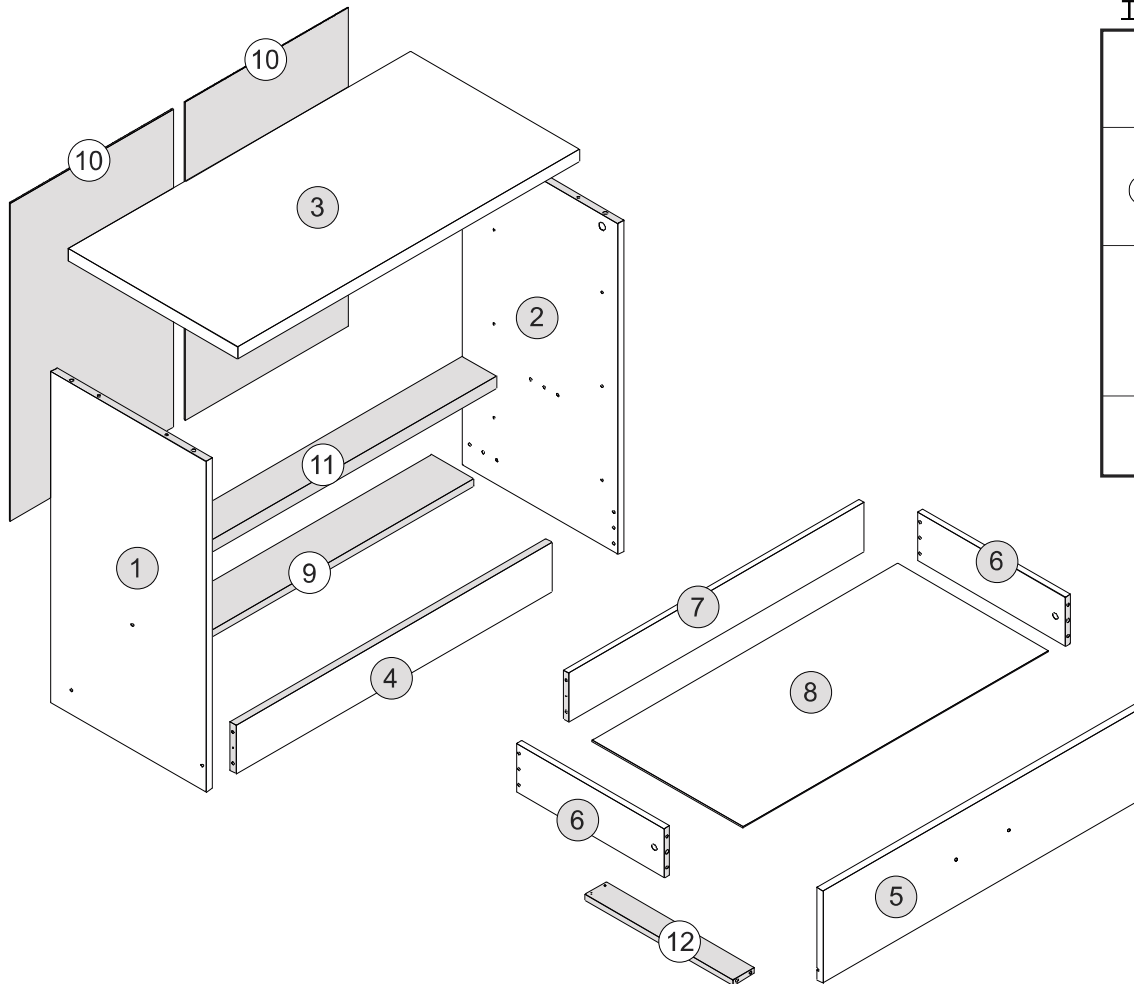

TOOLS REQUIRED

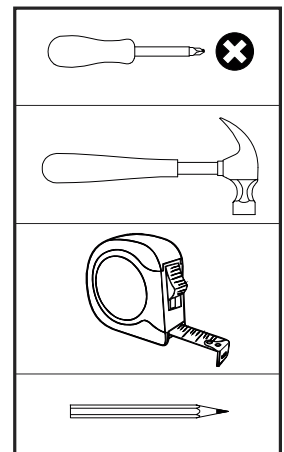









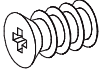
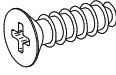
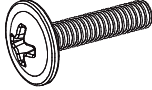
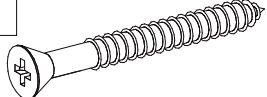

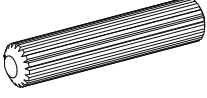
**PARTS LIST*****Please Note:***

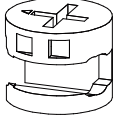
The below parts have all been stamped with the part number to help identify them during assembly.

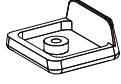
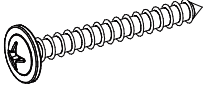
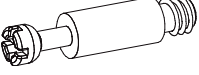
Part Number	Part Description	Quantity	Carton
01	Left Side Panel	1	1/1
02	Right Side Panel	1	1/1
03	Top Panel	1	1/1
04	Front Baseboard	1	1/1
05	Drawer Front	3	1/1
06	Drawer Side	6	1/1
07	Drawer Back Panel	3	1/1
08	Drawer Bottom	3	1/1
09	Back Baseboard	1	1/1
10	Back Panel	2	1/1
11	Crossbar	1	1/1
12	Drawer Bottom Support Bar	3	1/1

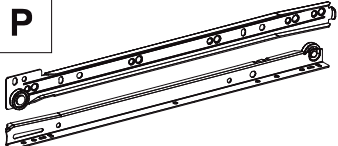
FITTINGS LIST

SEC/SH/09/21/HV1

<p>A</p>  <p>Flat Head Screw 2/+ Ø6,0 x 10mm (12x)</p>	<p>B</p>  <p>Flat Head Screw 2/+ Ø4,0 x 14mm (18x)</p>	<p>C</p>  <p>Flan Head Screw Ø4,0 x 20mm (6x)</p>	<p>D</p>  <p>Flat Head Screw 1/+ Ø3,5 x 40mm (6x)</p>
<p>E</p>  <p>Flat Head Screw 2/+ Ø4,0 x 50mm (12x)</p>	<p>F</p>  <p>2/+ Dowel Ø6,0 x 30mm (46x)</p>	<p>G</p>  <p>2/+ Nail 10x10 Ringed-1,5x23mm (56x)</p>	<p>H</p>  <p>1/+ Cam Nut Ø12x8 8mm (6x)</p>
<p>I</p>  <p>1/+ Cam Nut Ø14,9x11 mm (4x)</p>	<p>J</p>  <p>1/+ Washer Ø16x7 (4x)</p>	<p>K</p>  <p>1/+ Plastic Foot L 19x17x8mm Ø2 (6x)</p>	<p>L</p>  <p>1/+ Flan Head Screw Ø3,5 x 30mm (2x)</p>
<p>M</p>  <p>2/+ Cam Bolt (10x)</p>	<p>N</p>  <p>2/+ Hole Plugs 19mm (6x)</p>	<p>O</p>  <p>Glue 10 Gr(2x)</p>	<p>P</p>  <p>Drawer Runners 350mm(3x)</p>
<p>Q</p>  <p>Back Panel Strip H619x19x3 8MM (1x)</p>	<p>R</p>  <p>Strap 200x20x1MM (2x)</p>	<p>S</p>  <p>Handle (3x)</p>	<p>T</p>  <p>+2 Hole Plugs Líneo 19mm(6x)</p>

TIPS FOR FITTINGS CAM-LOCKS

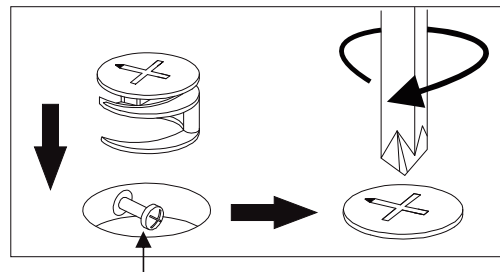
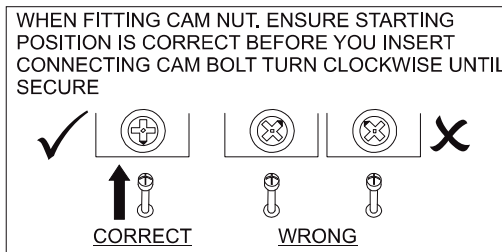

Cam bolt head needs to be in centre

CAMBOLT

Tighten until shoulder in flush with panel. Do not overtighten or undertighten (see example below)

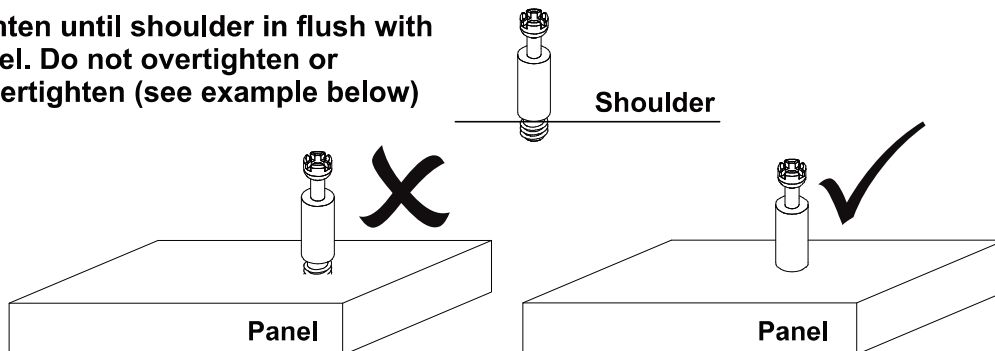

STEP 1

PARTS REQUIRED

1 - LEFT SIDE PANEL x1

HARDWARE REQUIRED

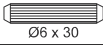
F  02
Ø6 x 30

G  02
10 x 10

K  02

O  01
GLUE

TOOLS REQUIRED

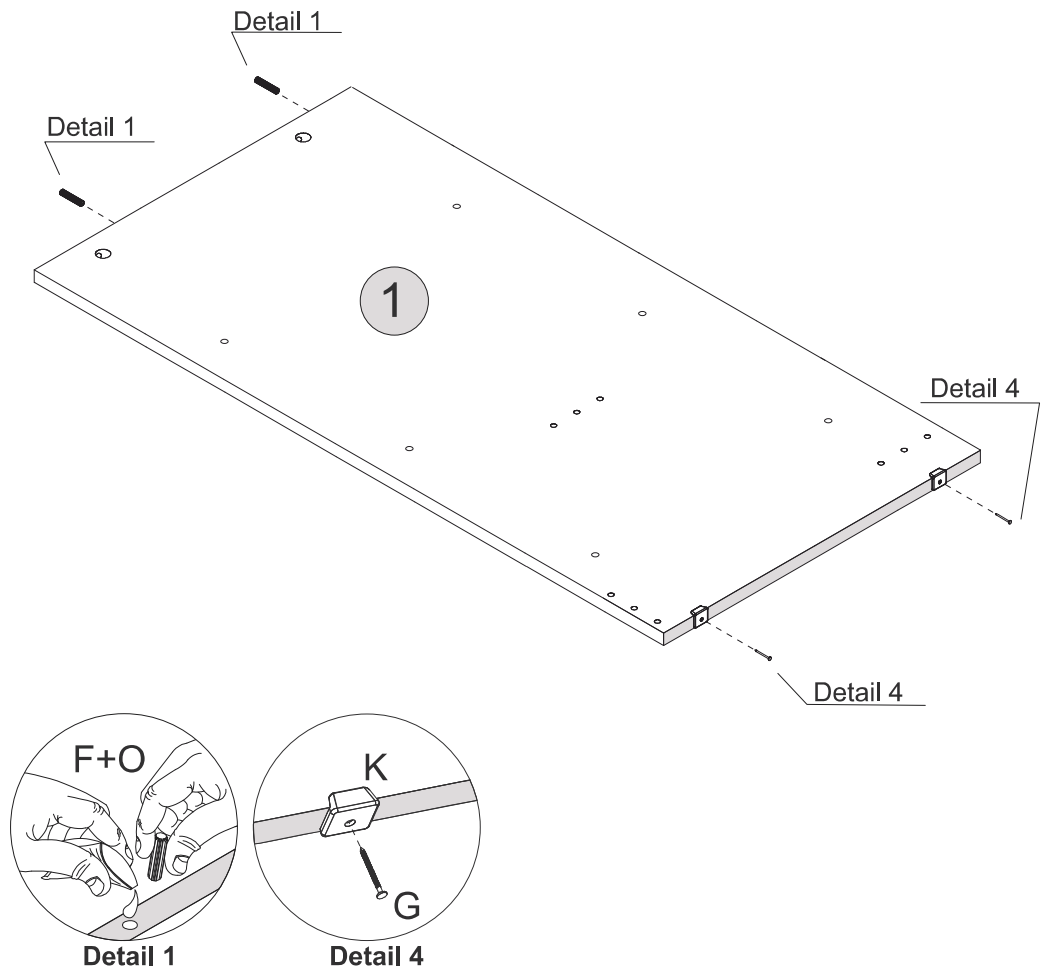
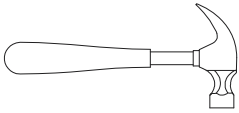

STEP 2

PARTS REQUIRED

2 - RIGHT SIDE PANEL x1

HARDWARE REQUIRED

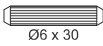
F  02
Ø6 x 30

G  02
10 x 10

K  02

O  01
GLUE

TOOLS REQUIRED

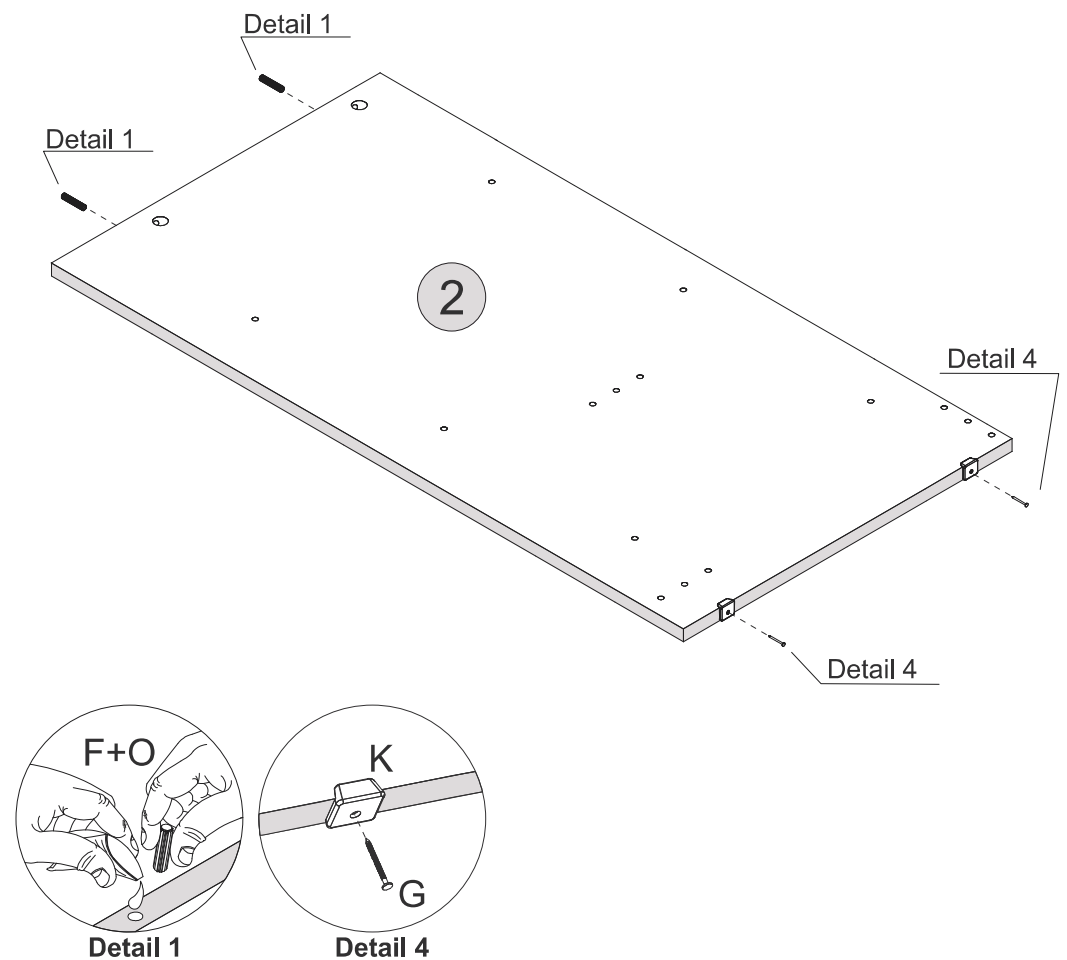
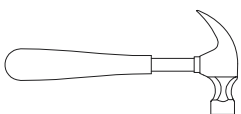



STEP 3

PARTS REQUIRED

1 - LEFT SIDE PANEL x1

HARDWARE REQUIRED

A  06
Ø6,0 x 10mm

B  03
Ø4,0 x 14mm

P  03
LEFT

TOOLS REQUIRED

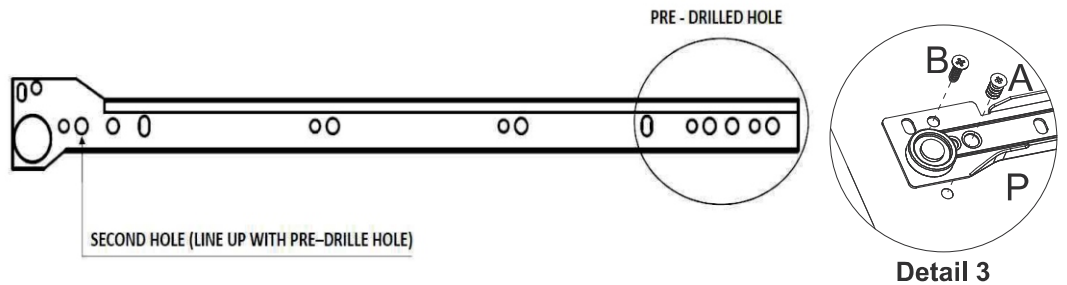
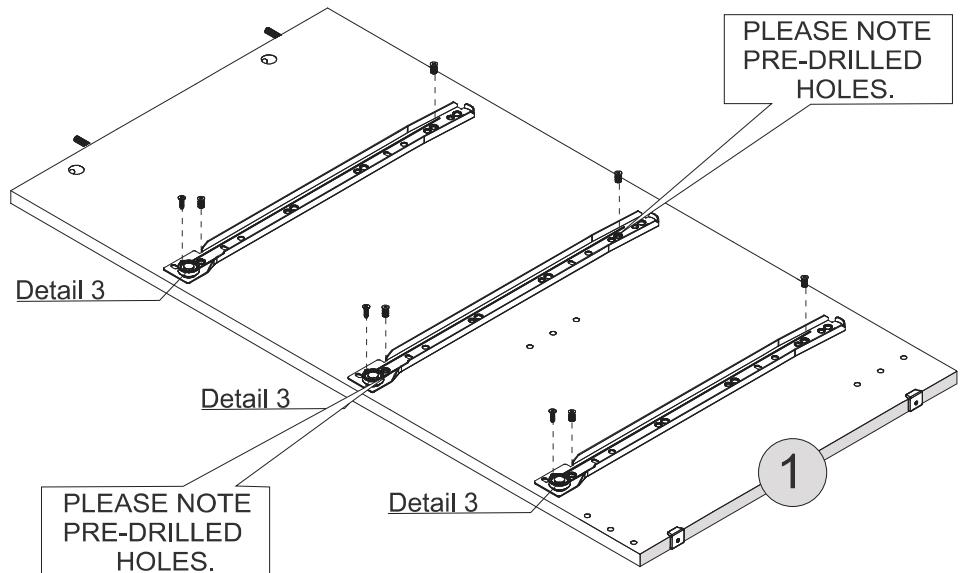
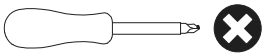



STEP 4

PARTS REQUIRED

2 - RIGHT SIDE PANEL x1

HARDWARE REQUIRED

A  06
Ø6,0 x 10mm

B  03
Ø4,0 x 14mm

P  03
RIGHT

TOOLS REQUIRED

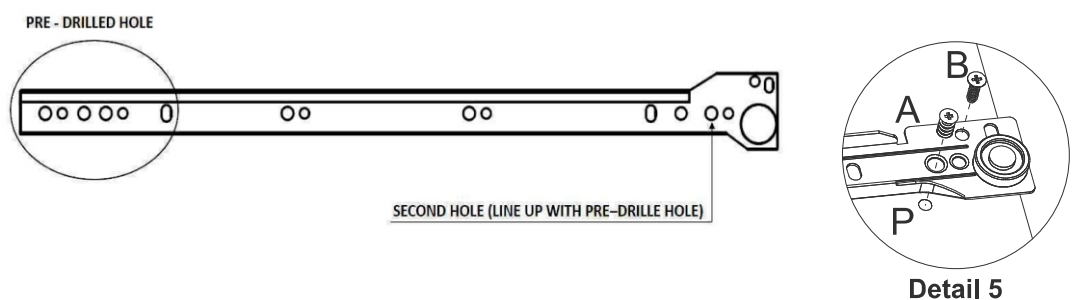
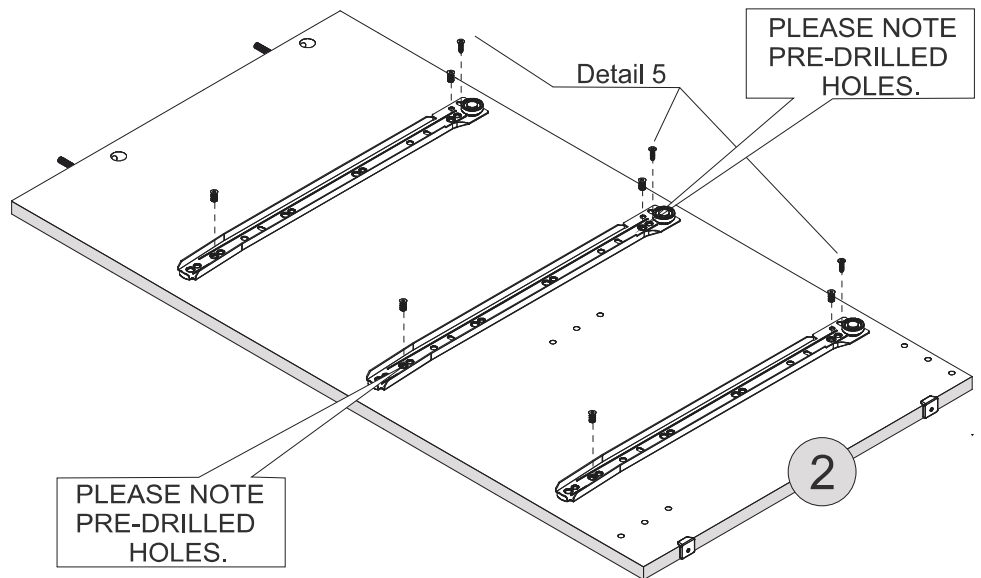
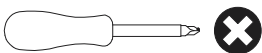





STEP 5

PARTS REQUIRED

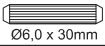
4 - FRONT BASEBOARD	x1
9 - BACK BASEBOARD	x1
11 - CROSSBAR	x1

HARDWARE REQUIRED

F		12
G		02
K		02
O		01

TOOLS REQUIRED

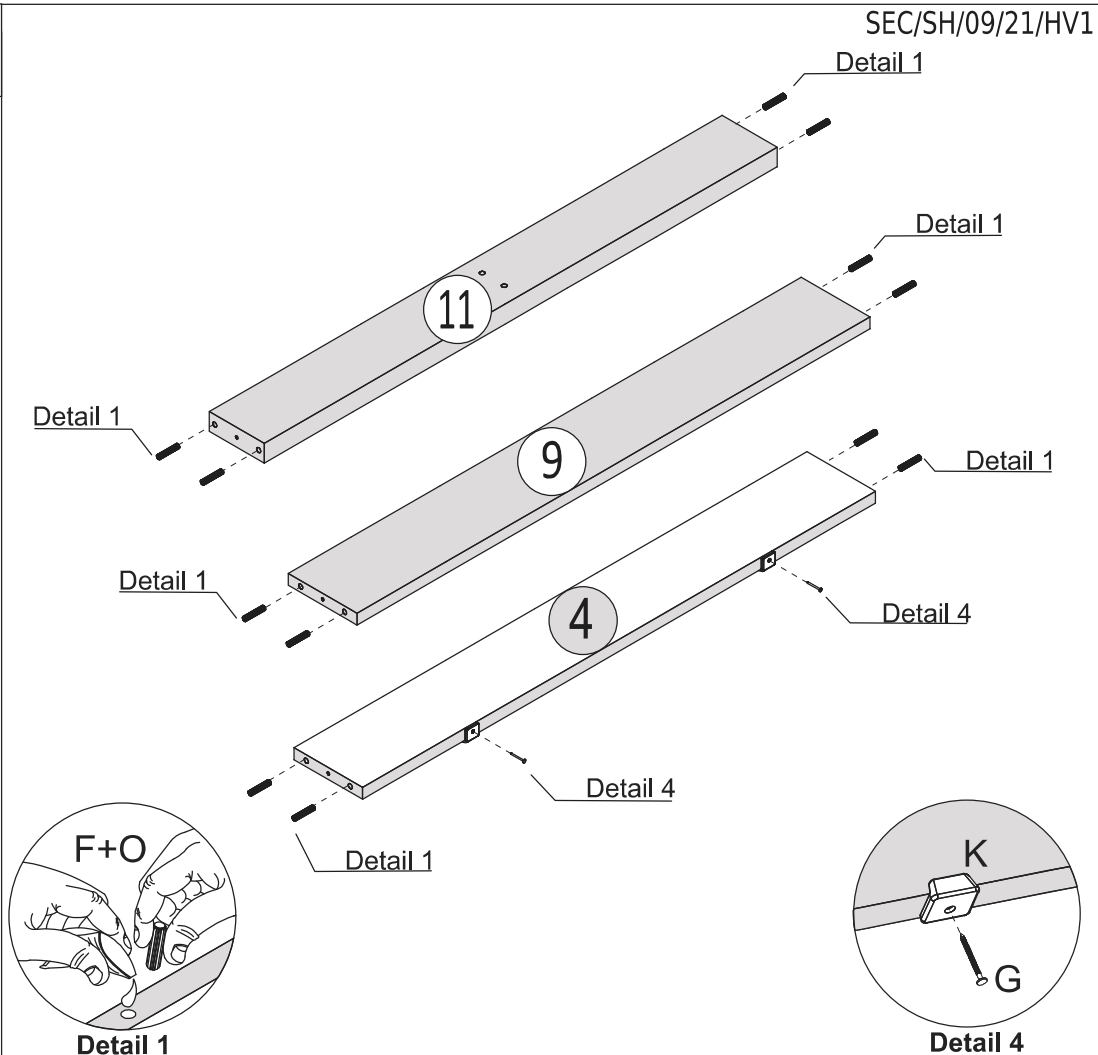
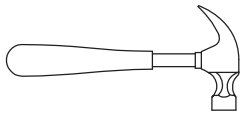



STEP 6

PARTS REQUIRED

2 - RIGHT SIDE PANEL	x1
4 - FRONT BASEBOARD	x1
9 - BACK BASEBOARD	x1
11 - CROSSBAR	x1

HARDWARE REQUIRED

E		03
O		01

TOOLS REQUIRED

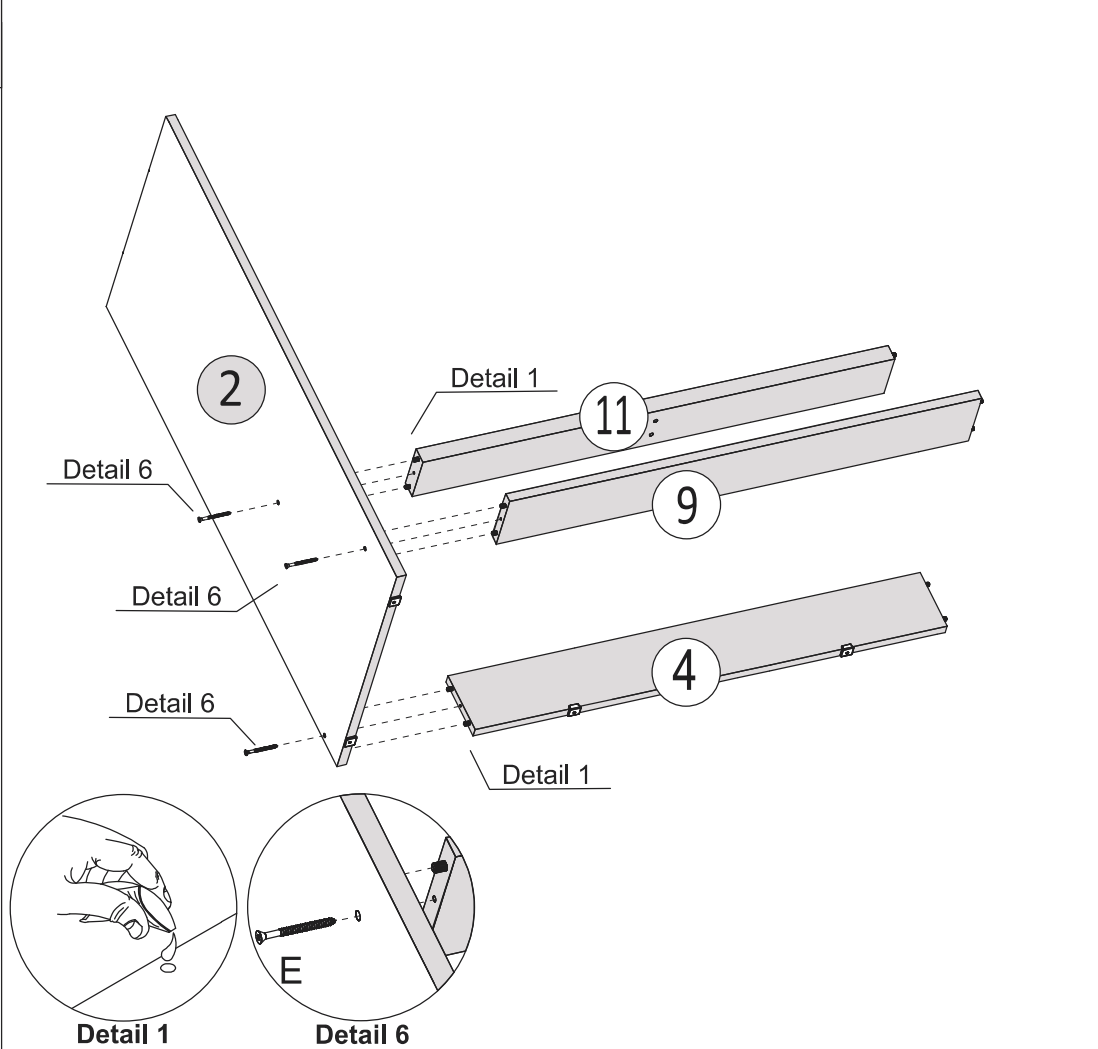
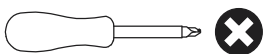

STEP 7

PARTS REQUIRED

1 - LEFT SIDE PANEL x1

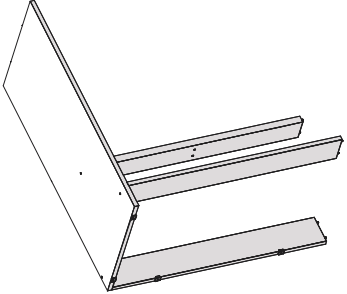

HARDWARE REQUIRED

E  03
Ø4,0 x 50mm

O  01
GLUE

TOOLS REQUIRED

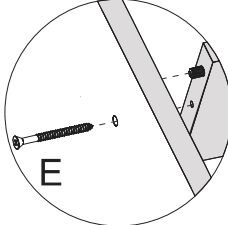
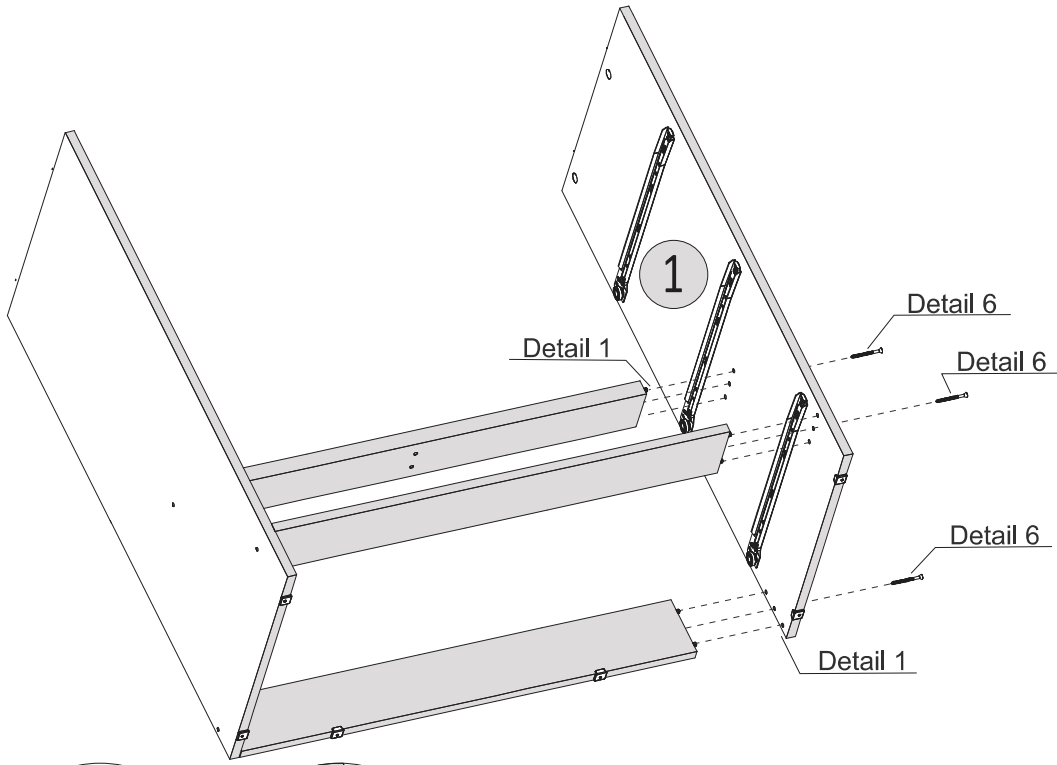
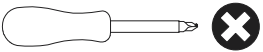

Detail 1

Detail 6

STEP 8

PARTS REQUIRED

3 - TOP PANEL x1

HARDWARE REQUIRED

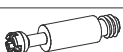
M  04

TOOLS REQUIRED

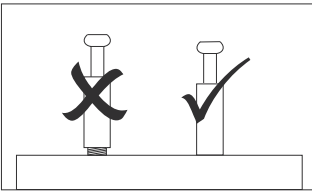
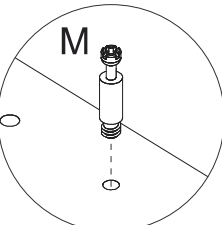
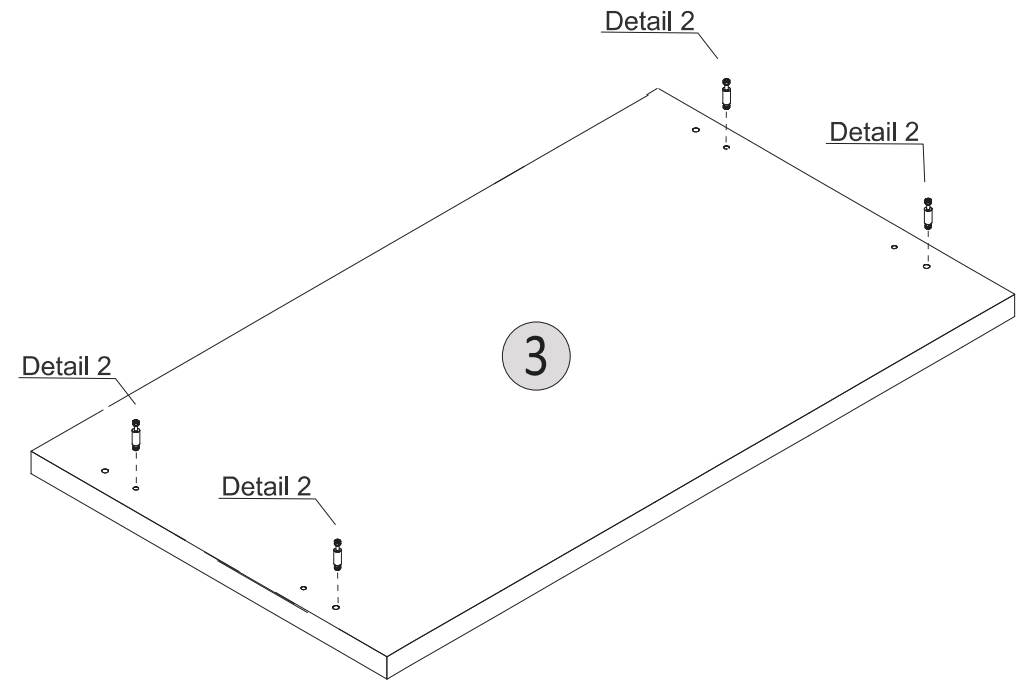
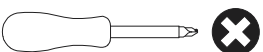

Detail 2

STEP 9

PARTS REQUIRED

3 - TOP PANEL x1

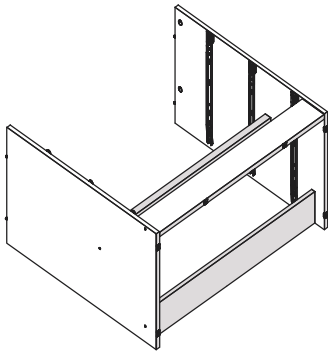

HARDWARE REQUIRED

I  04

K  GLUE 01

TOOLS REQUIRED

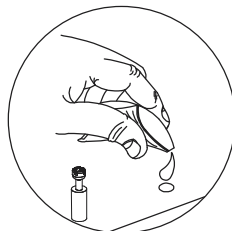
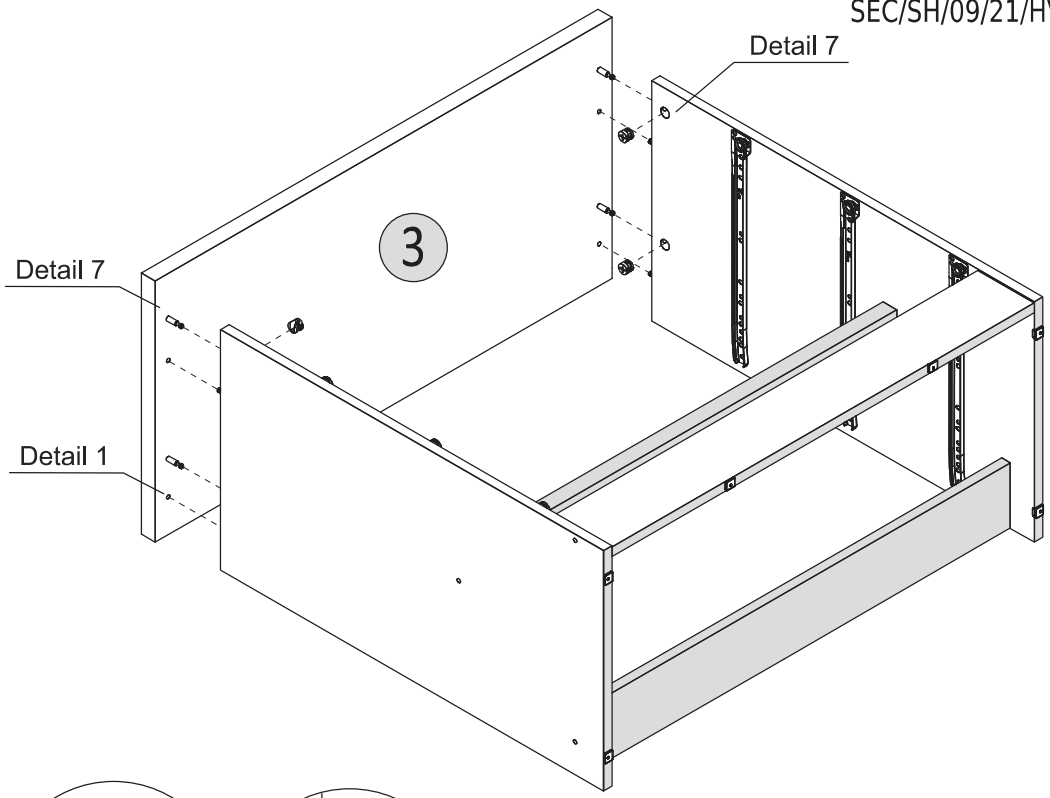
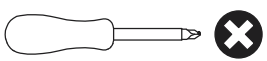

Detail 1

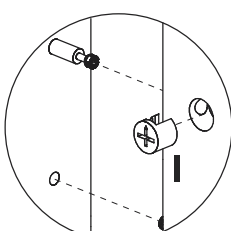

Detail 7

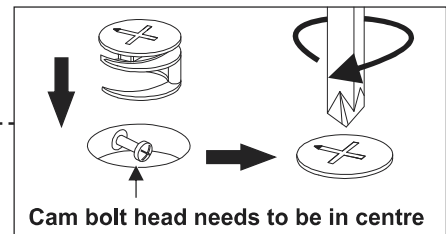

Cam bolt head needs to be in centre

STEP 10

PARTS REQUIRED

10 - BACK PANEL x2

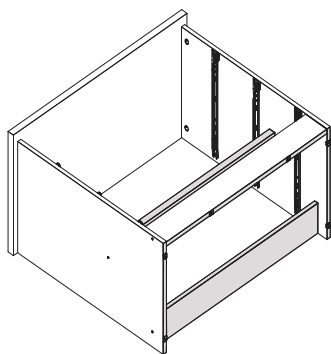

HARDWARE REQUIRED

G  20

Q  01

TOOLS REQUIRED

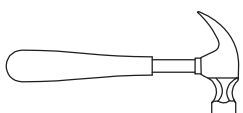

Detail 8

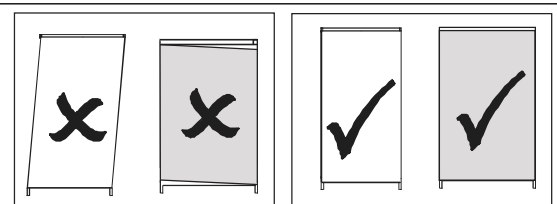

* For your future reference
Order Number should be here

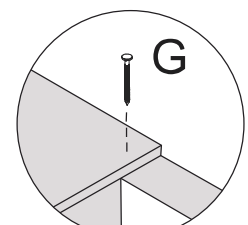
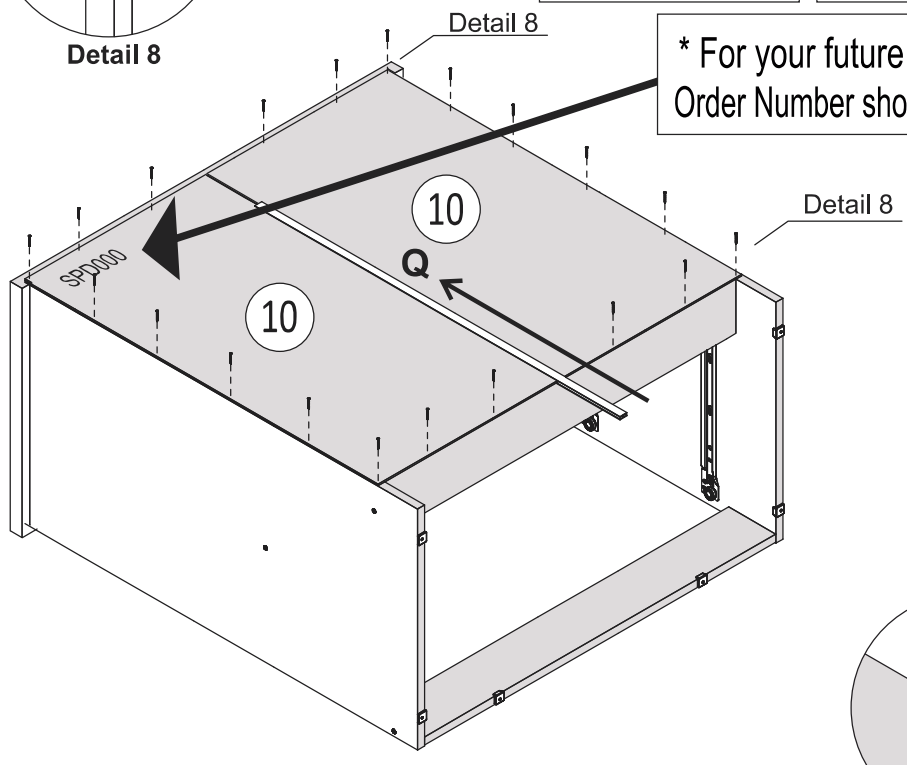

Detail 8

STEP 11

PARTS REQUIRED

6 - DRAWER SIDE x6

7 - DRAWER BACK PANEL x3

12 - DRAWER BOTTOM SUPPORT BAR x3

HARDWARE REQUIRED

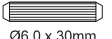
F  30
Ø6,0 x 30mm

O  01
GLUE

TOOLS REQUIRED

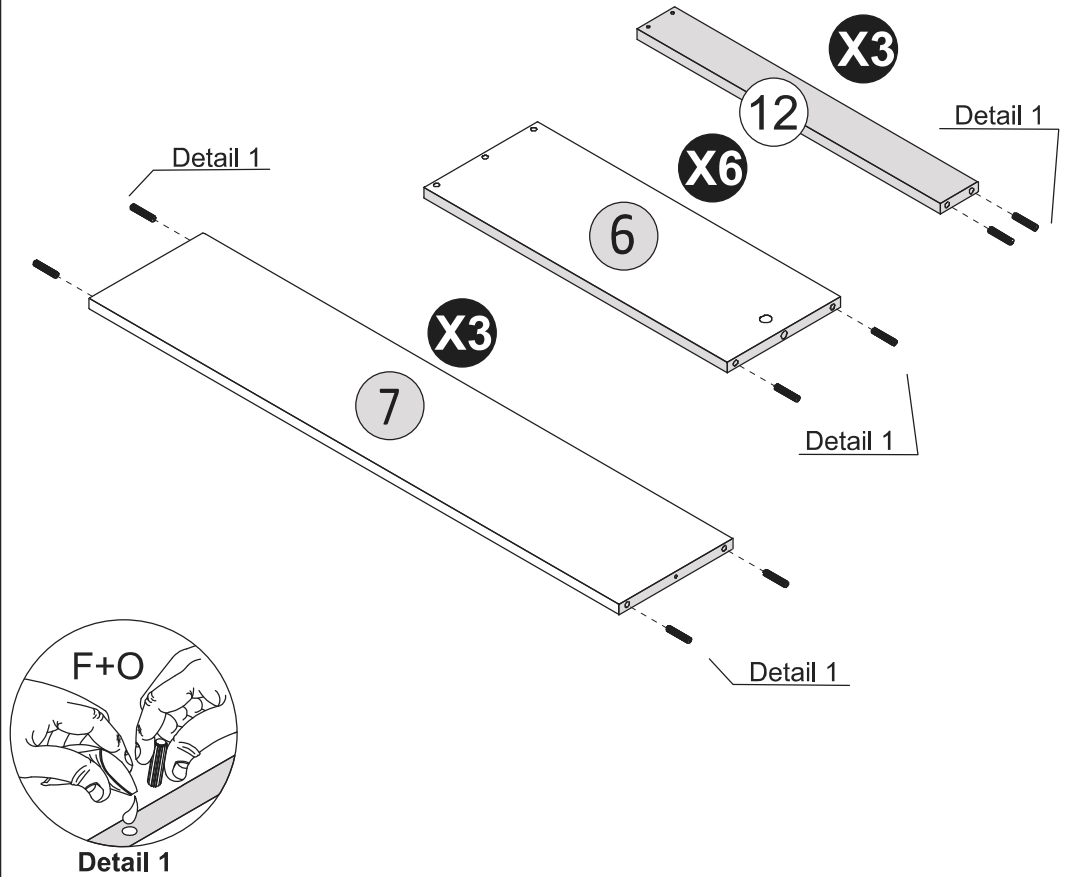

STEP 12

PARTS REQUIRED

5 - DRAWER FRONT x3

HARDWARE REQUIRED

M  06

TOOLS REQUIRED

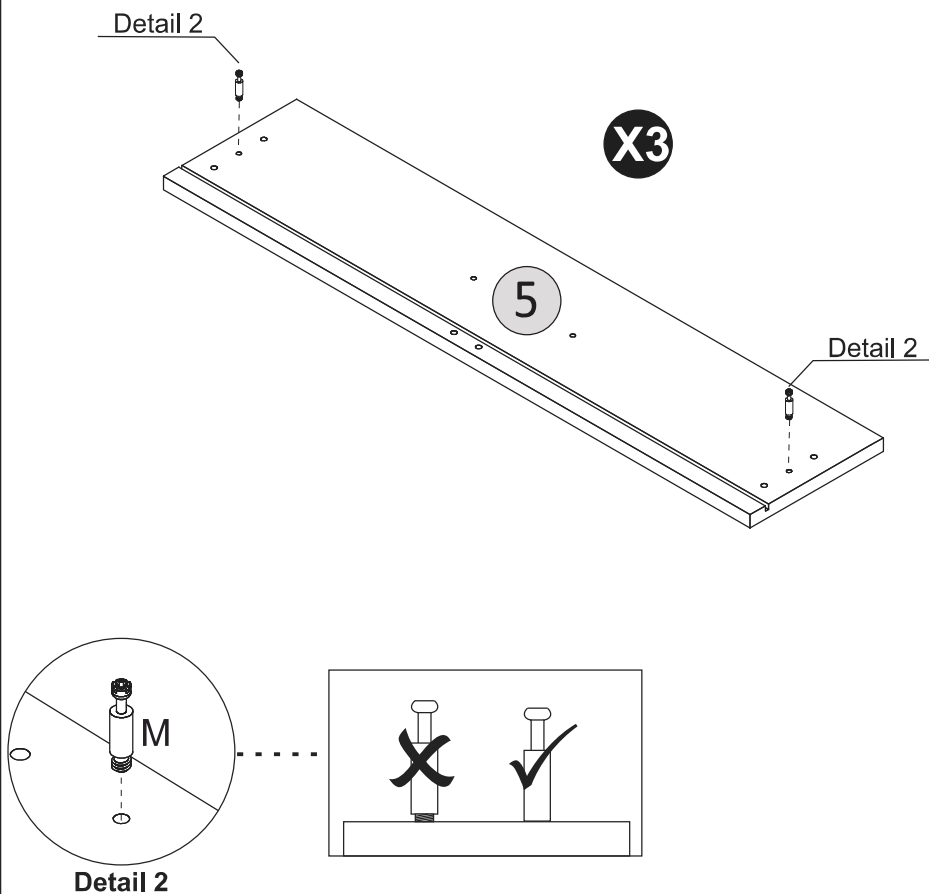
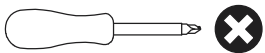

STEP 13

PARTS REQUIRED

6 - DRAWER SIDE x6

7 - DRAWER BACK PANEL x3

HARDWARE REQUIRED

E  06
Ø4,0 x 50mm

TOOLS REQUIRED

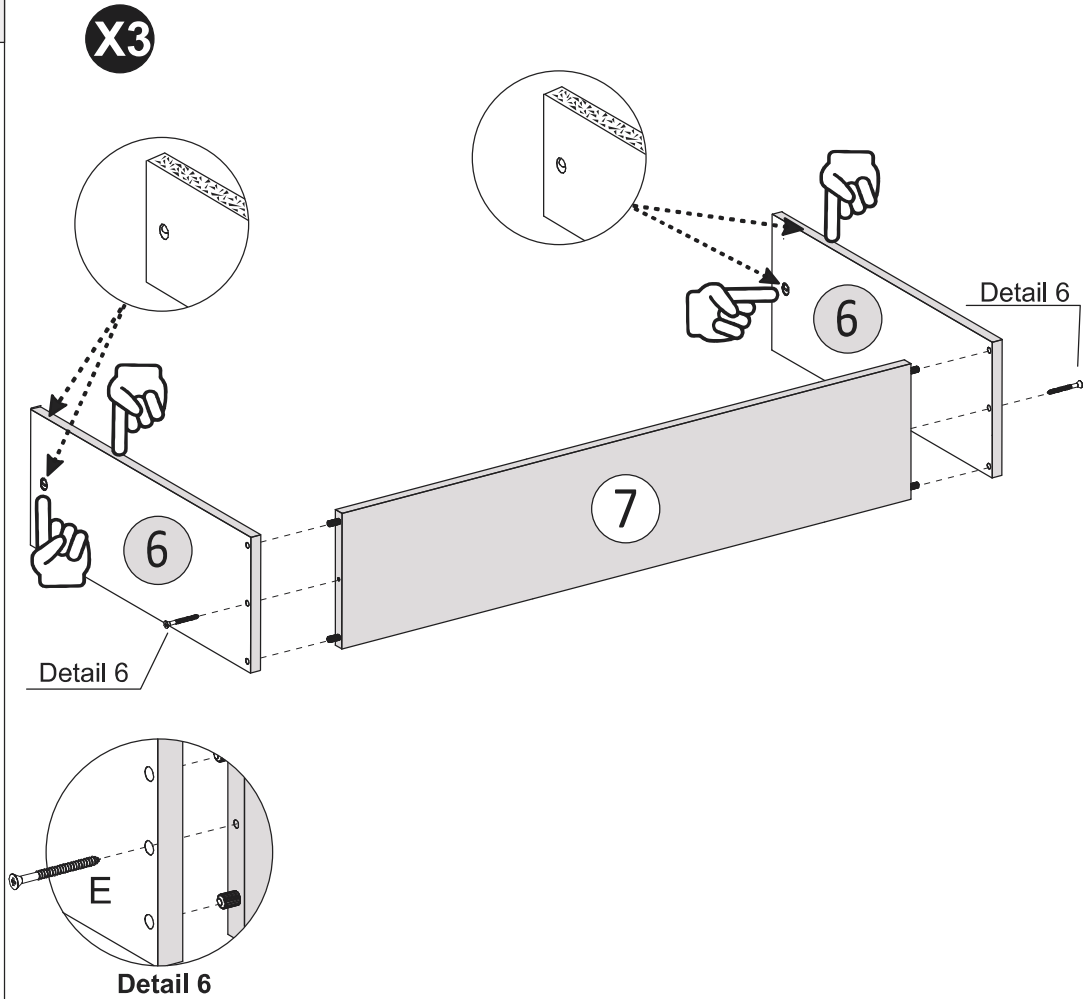
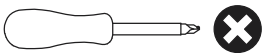

STEP 14

PARTS REQUIRED

5 - DRAWER FRONT x3

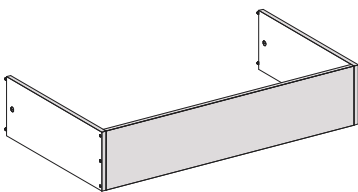

HARDWARE REQUIRED

H  06

K  GLUE 01

TOOLS REQUIRED

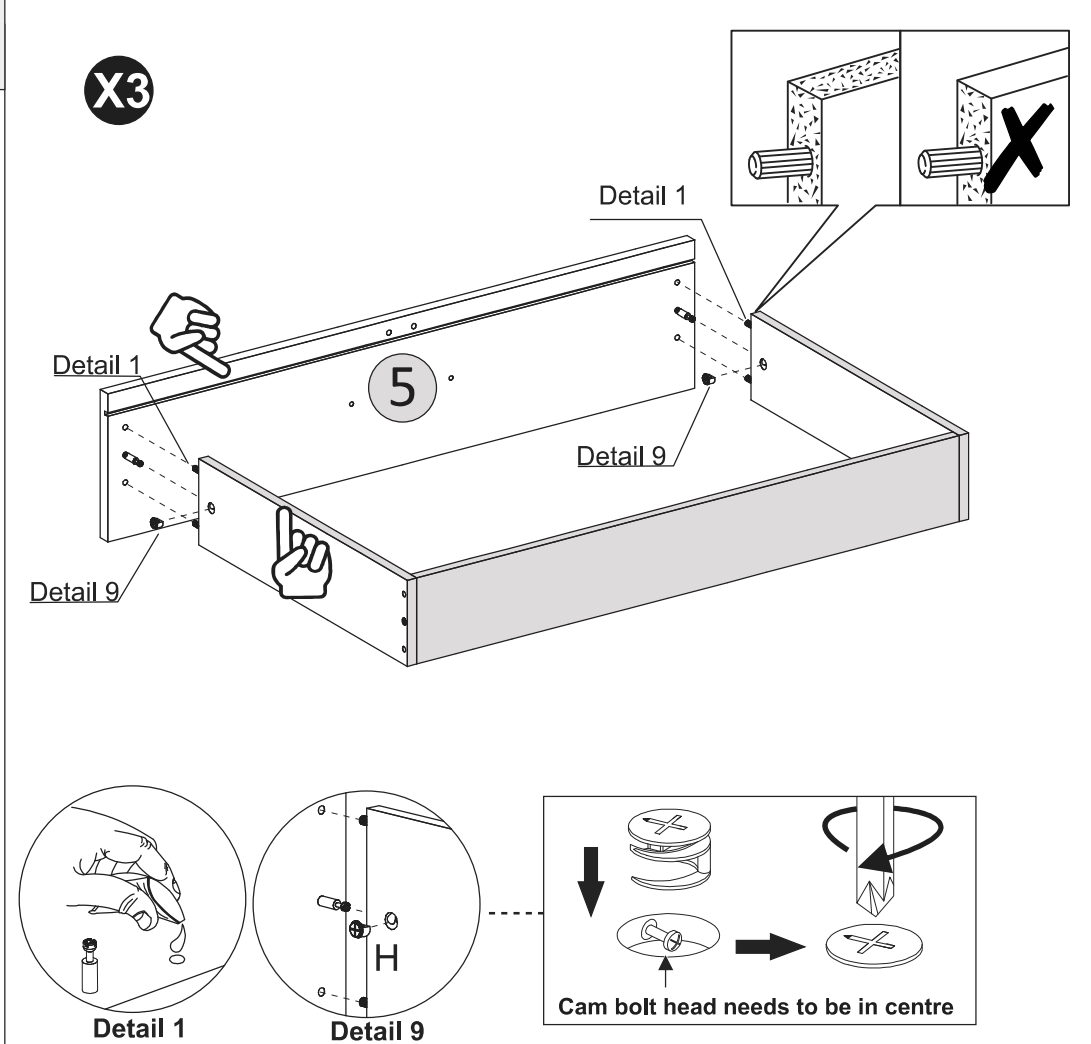
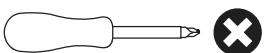

STEP 15

PARTS REQUIRED

8 - DRAWER BOTTOM x3

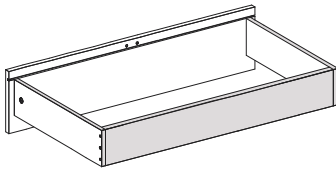

HARDWARE REQUIRED

G 10 x 10 12

TOOLS REQUIRED

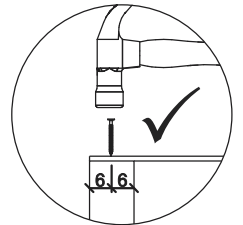
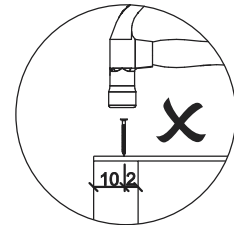
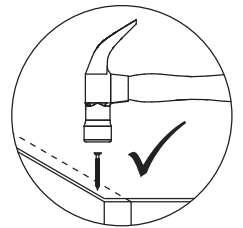
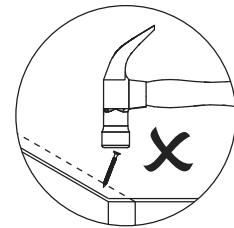
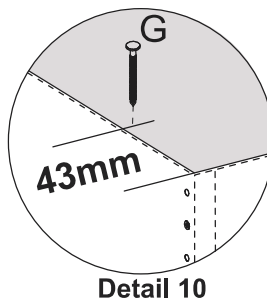
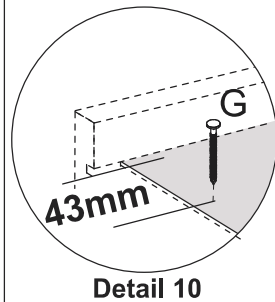
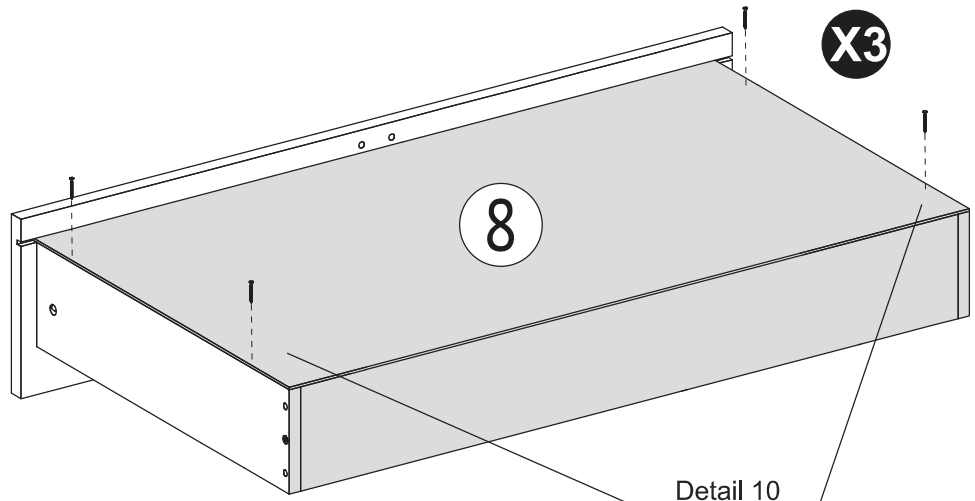
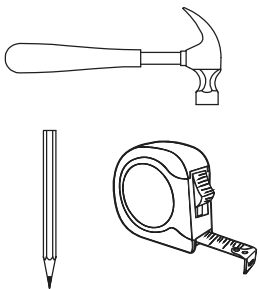

STEP 16

PARTS REQUIRED

12 - DRAWER BOTTOM SUPPORT BAR X3

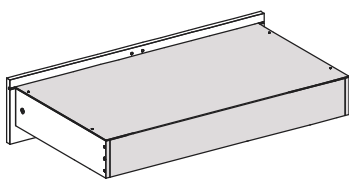

HARDWARE REQUIRED

G 10 x 10 18

TOOLS REQUIRED

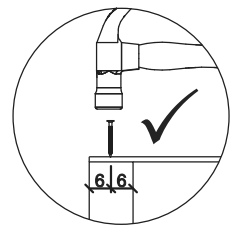
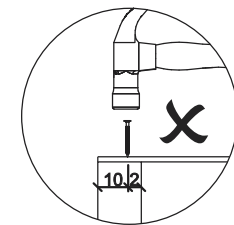
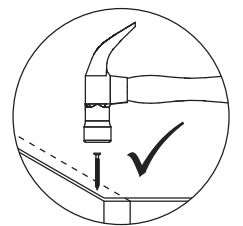
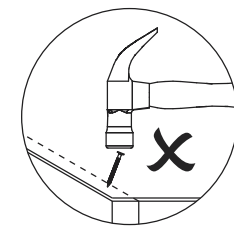
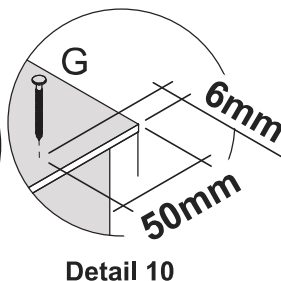
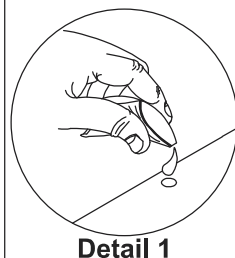
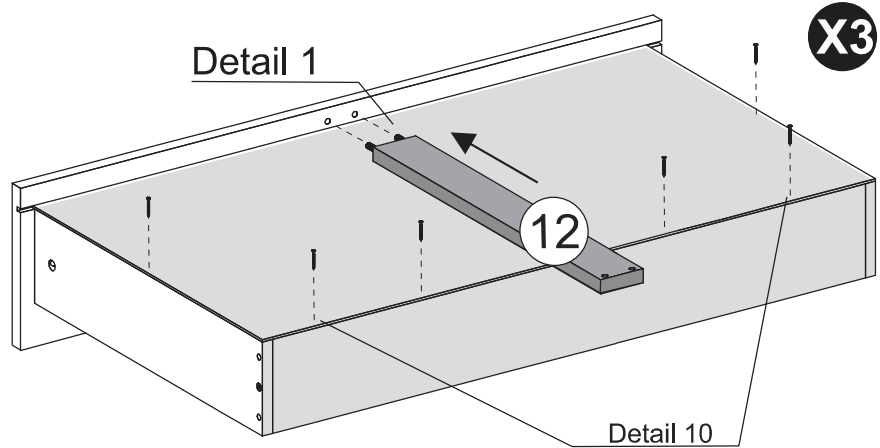
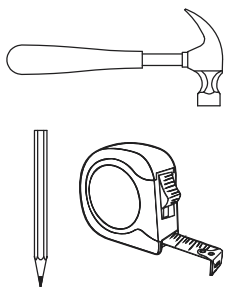

STEP 17

PARTS REQUIRED

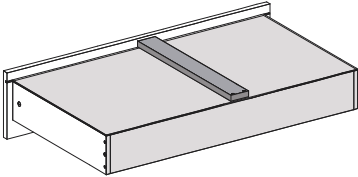

HARDWARE REQUIRED

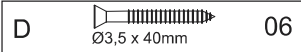
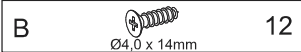

TOOLS REQUIRED

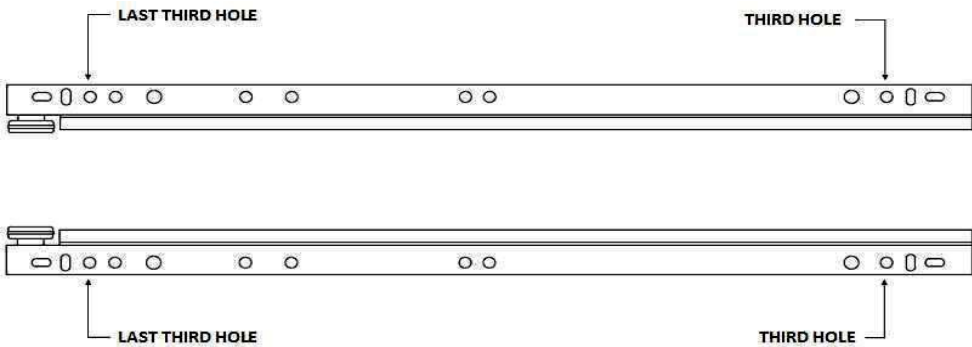
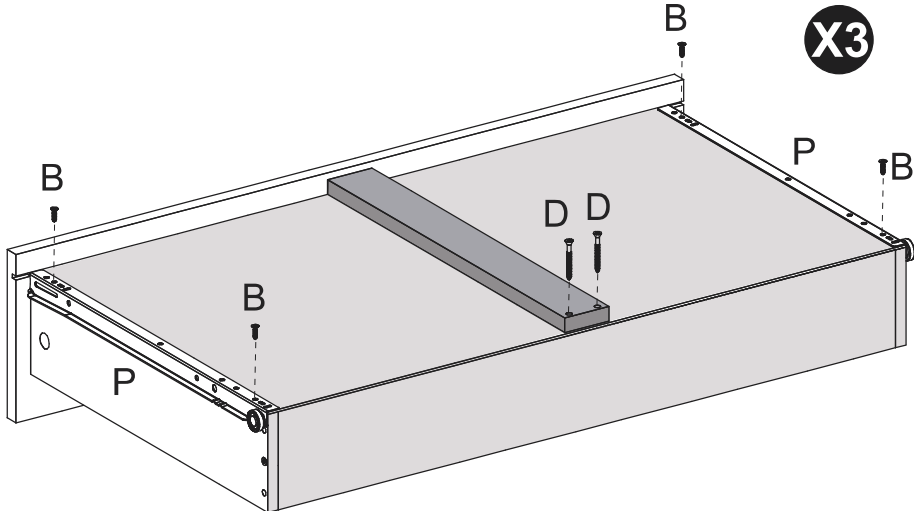
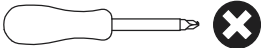

STEP 18

PARTS REQUIRED

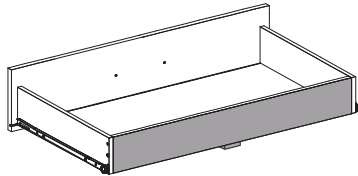

HARDWARE REQUIRED

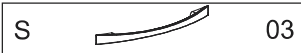

TOOLS REQUIRED

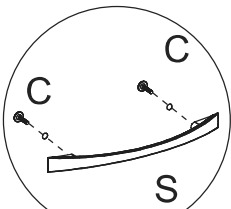
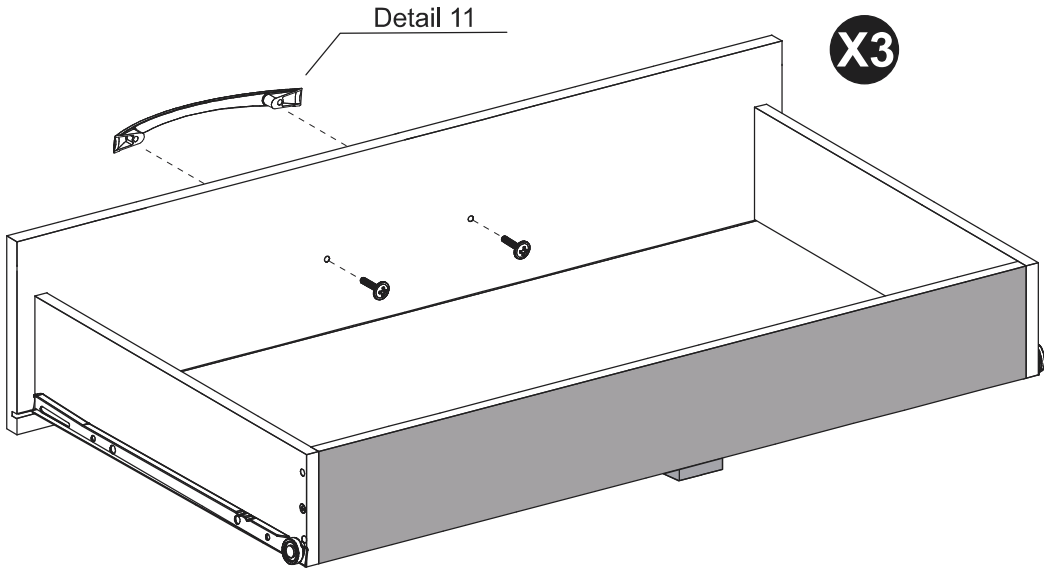
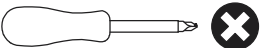

Detail 11

STEP 19

PARTS REQUIRED

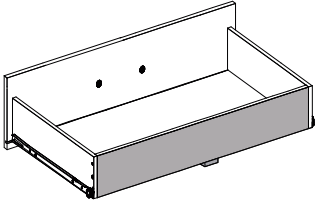

HARDWARE REQUIRED

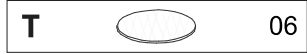

TOOLS REQUIRED

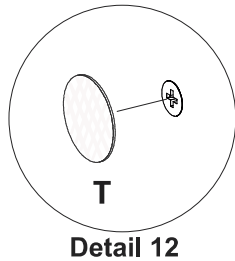
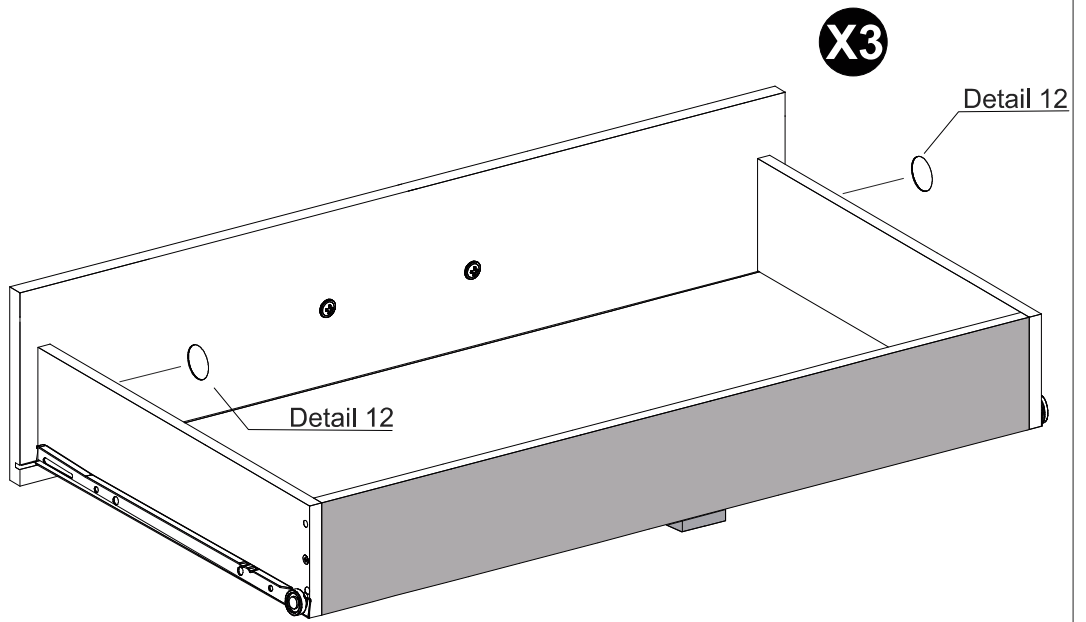

STEP 20

PARTS REQUIRED

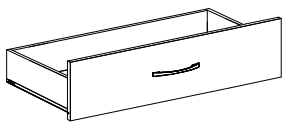
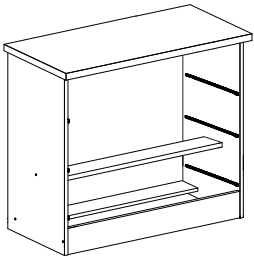

HARDWARE REQUIRED

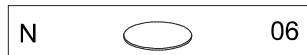

TOOLS REQUIRED

See the last page

See the last page

Detail 12

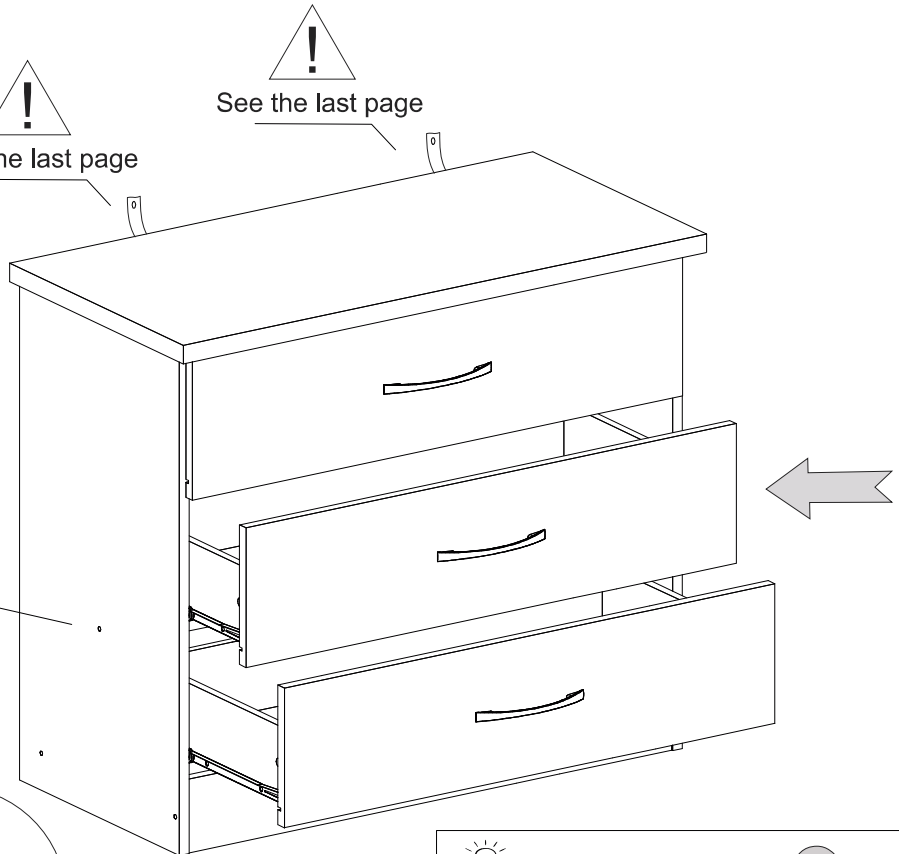
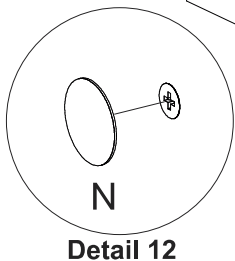

TIP

If desired, after assembly use an alcohol cleaner to erase the number printed on the parts.

WARNING

Serious or fatal injuries can occur from furniture tipping over. To prevent the furniture from tipping over we recommend that it is permanently fixed to the wall.

Wall fixings are not supplied with this product as different wall materials require different types of fixing devices.
Please make sure you use fixings suitable for the walls in your home.

