

# NEVADA 6 DRAWER CHEST

## ASSEMBLY INSTRUCTIONS

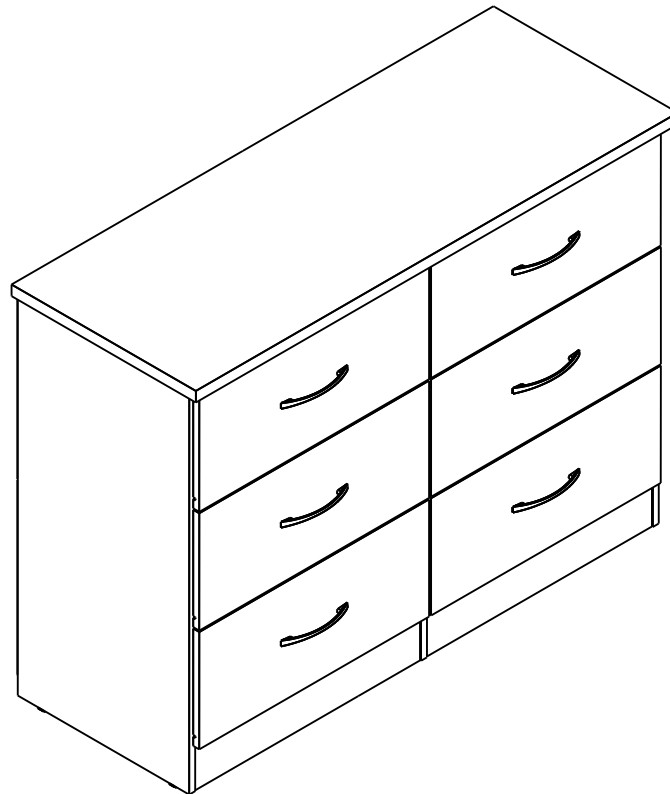

**IMPORTANT**  
**FOR DOMESTIC USE ONLY**  
**PLEASE READ BEFORE YOU CONTINUE FURTHER**

## CARE AND MAINTENANCE

After unpacking this product please keep the original packaging in case it needs to be returned for any reason.

- Please ensure all fittings and parts are present before commencing with assembly.
- Never drag or push products as this could cause damage to the joints making it inferior.
- We strongly recommend that you keep children away from your work area.
- We recommend that you lay a blanket or sheet on the floor to avoid damage to both your floor and the product.
- Assemble this product as close to its final position as possible.
- Do not place this product next to a radiator or in direct sunlight.
- Do not drag or push items across your high gloss furniture as this may cause the surface to scratch
- Wood is a natural product and may expand if subjected to damp and may shrink or crack if subjected to heat. Therefore it is recommended that room temperature is maintained, with no sudden temperature fluctuations.
- Make sure any spillage is wiped off immediately.
- Do not place hot or chilled items directly on to the surface, use a place mat or marking will occur.
- For general cleaning use a soft cotton or micro fibre cloth, and do not use detergents of any kind.
- From time to time it may be necessary to tighten fittings, regular inspections should be carried out.
- Do not place on a wet or damp floor as staining may occur to your floor.



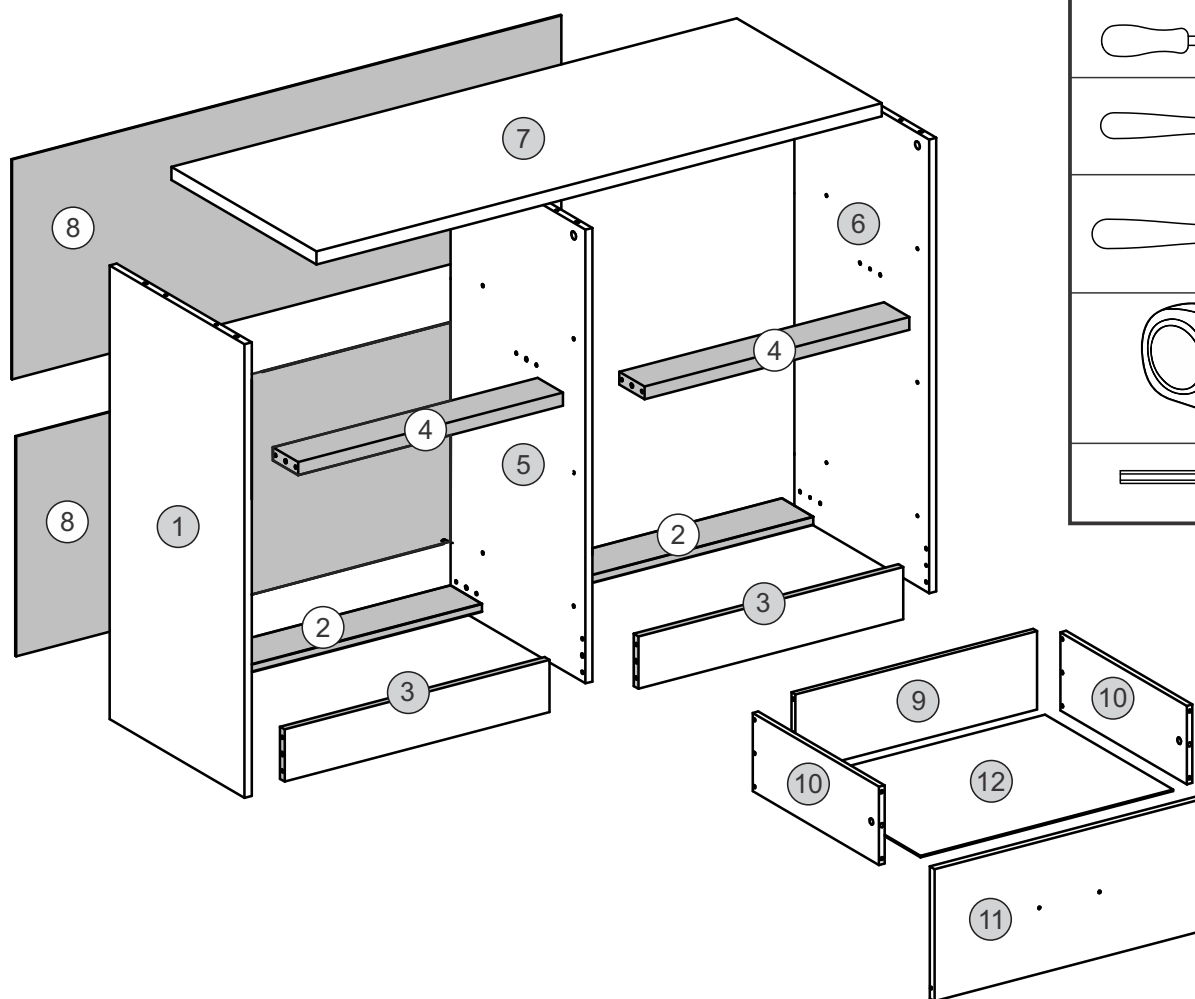
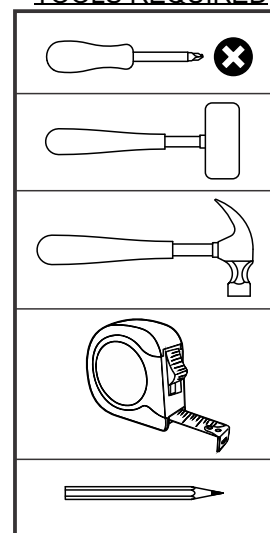







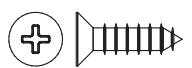
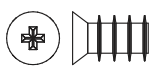
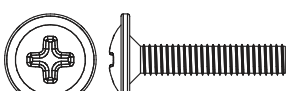

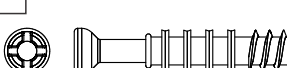

## TOOLS REQUIRED

***Please Note:***

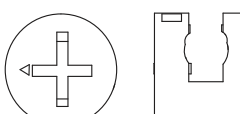
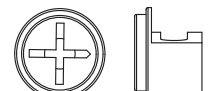
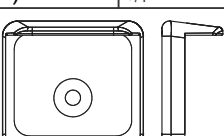
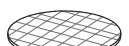
The below parts have all been stamped with the part number to help identify them during assembly.

<b>Part Number</b>	<b>Part Description</b>	<b>Quantity</b>	<b>Carton</b>
01	Left Side Panel	1	1/2
02	Back Baseboard	2	1/2
03	Front Baseboard	2	1/2
04	Crossbar	2	1/2
05	Division Panel	1	1/2
06	Right Side Panel	1	1/2
07	Top Panel	1	2/2
08	Back Panel	2	2/2
09	Drawer Back Panel	6	1/2
10	Drawer Side	12	2/2
11	Drawer Front	6	2/2
12	Drawer Bottom	6	2/2

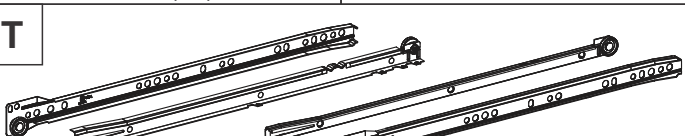
## FITTINGS LIST

<p><b>A</b></p>  <p>Flat Head Screw Ø4,0 x 14mm (36x)</p> <p>+/2</p>	<p><b>B</b></p>  <p>Flat Head Screw Ø6,0 x 10mm (12x)</p> <p>+/2</p>	<p><b>C</b></p>  <p>Flan Head Screw Ø4,0 x 20mm (12x)</p> <p>+/2</p>	<p><b>D</b></p>  <p>Flan Head Screw Ø3,5 x 30mm (2x)</p> <p>+/1</p>
<p><b>E</b></p>  <p>Flat Head Screw Ø4,0x 50mm (12x)</p> <p>+/2</p>	<p><b>F</b></p>  <p>Dowel Ø6,0 x 30mm (66x)</p> <p>+/2</p>	<p><b>G</b></p>  <p>Dowel Ø6,0 x 50mm (6x)</p> <p>+/1</p>	
<p><b>H</b></p>  <p>Nail 10 x 10 (116x)</p> <p>+/2</p>	<p><b>I</b></p>  <p>Double Flat Head Screw Ø4,0 x 18mm (6x)</p> <p>+/1</p>	<p><b>J</b></p>  <p>Cam Bolt (24x)</p> <p>+/2</p>	<p><b>K</b></p>  <p>Double Cam Bolt (3x)</p> <p>+/1</p>
<p><b>L</b></p>  <p>Cam Nut Ø15mm (18x)</p> <p>+/2</p>	<p><b>M</b></p>  <p>Cam Nut Ø12mm (12x)</p> <p>+/2</p>	<p><b>N</b></p>  <p>Plastic Foot (6x)</p> <p>+/1</p>	<p><b>O</b></p>  <p>Hole Plugs (12x)</p> <p>+/2</p>
<p><b>P</b></p>  <p>Glue (2x)</p>	<p><b>Q</b></p>  <p>Strap (2x)</p>	<p><b>R</b></p>  <p>Washer (4x)</p> <p>+/1</p>	<p><b>S</b></p>  <p>Handle (6x)</p>
<p><b>T</b></p>  <p>Drawer Runners (6x)</p>		<p><b>U</b></p>  <p>Back Panel Strip (1x)</p>	

## TIPS FOR FITTINGS CAM-LOCKS

WHEN FITTING CAM NUT, ENSURE STARTING POSITION IS CORRECT BEFORE YOU INSERT CONNECTING CAM BOLT TURN CLOCKWISE UNTIL SECURE



↑

**CORRECT**



↑

**WRONG**



↑

**WRONG**



↑

**WRONG**

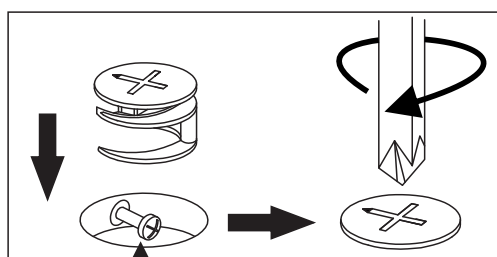

**Cam bolt head needs to be in centre**

### CAMBOLT

**Tighten until shoulder in flush with panel. Do not overtighten or undertighten (see example beside)**

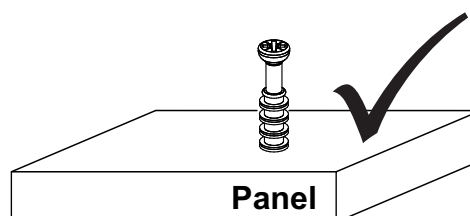
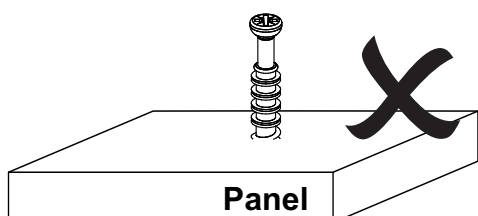
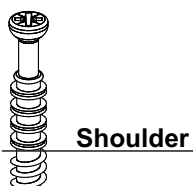

# STEP 1

## PARTS REQUIRED

2 - BACK BASEBOARD x2

3 - FRONT BASEBOARD x2

4 - CROSSBAR x2

## HARDWARE REQUIRED

F  12  
Ø6,0 x 30mm

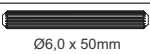
G  06  
Ø6,0 x 50mm

P  01  
Glue

## TOOLS REQUIRED

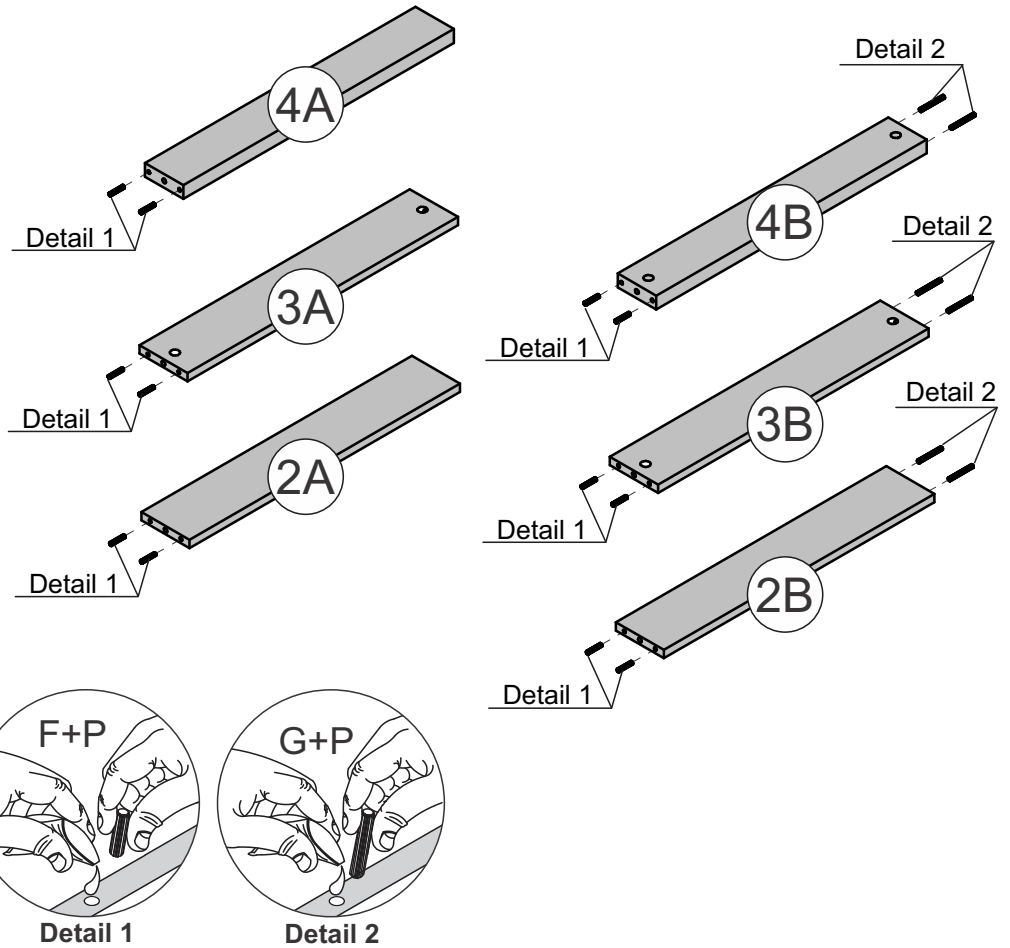
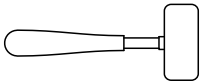

# STEP 2

## PARTS REQUIRED

7 - TOP PANEL x1

## HARDWARE REQUIRED

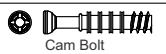
J  06  
Cam Bolt

## TOOLS REQUIRED

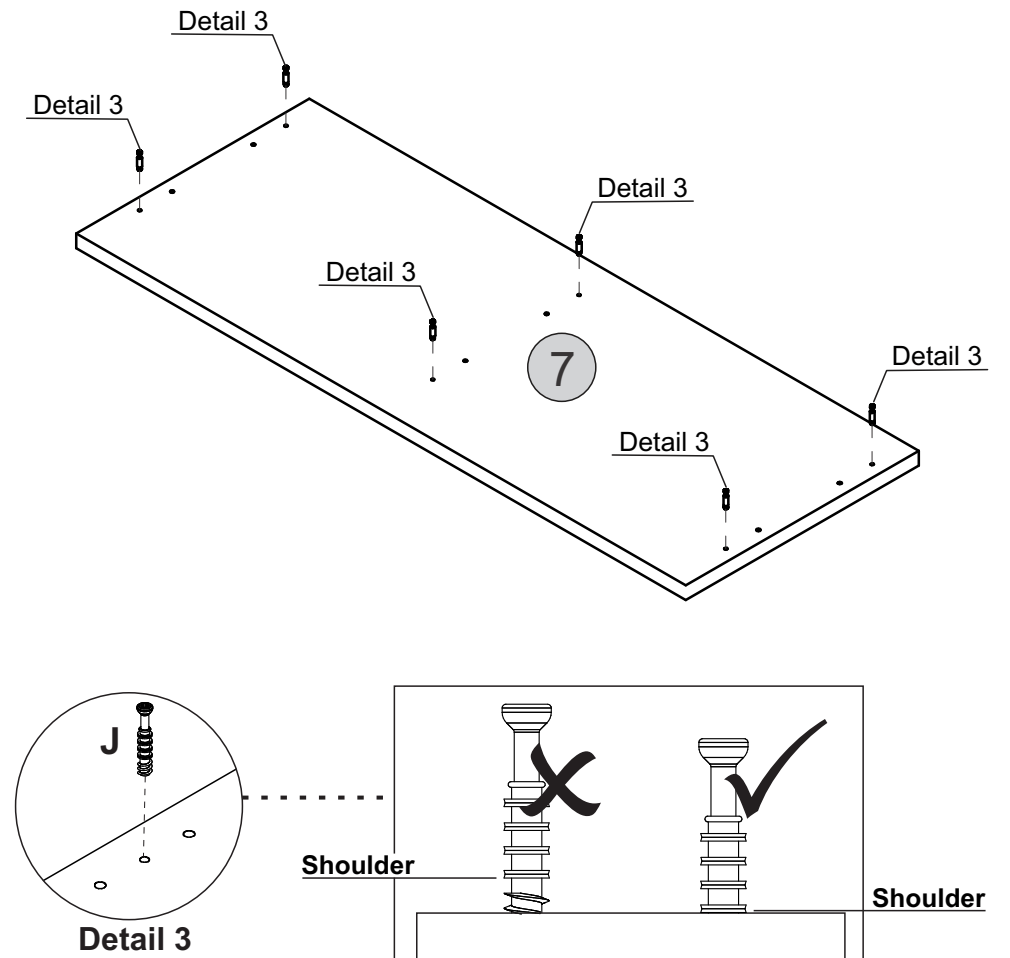
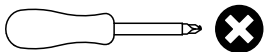

# STEP 3

## PARTS REQUIRED

6 - RIGHT SIDE PANEL x1

## HARDWARE REQUIRED

B  06  
Ø6,0 x 10mm

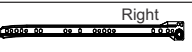
T  03  
Right

## TOOLS REQUIRED

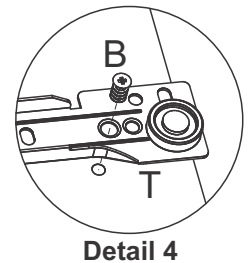
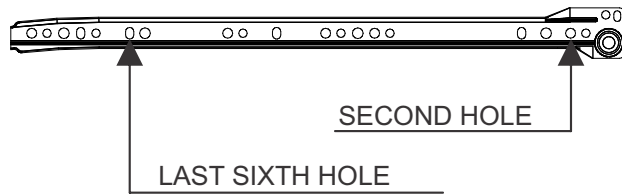
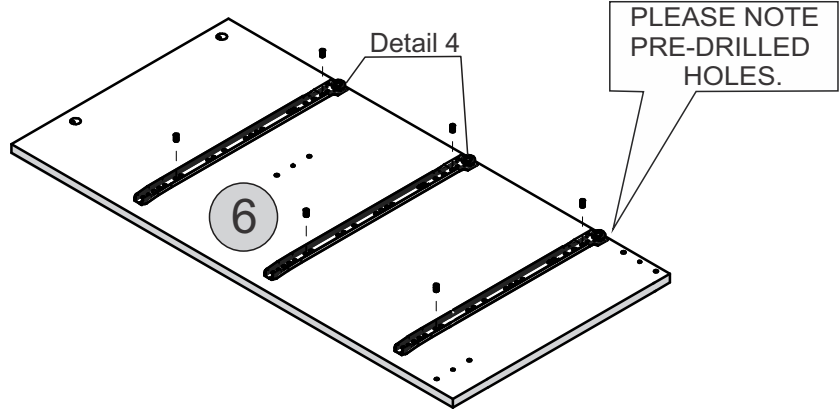
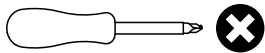

Detail 4

# STEP 4

## PARTS REQUIRED

1 - LEFT SIDE PANEL x1

## HARDWARE REQUIRED

B  06  
Ø6,0 x 10mm

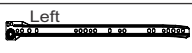
T  03  
Left

## TOOLS REQUIRED

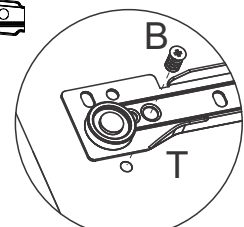
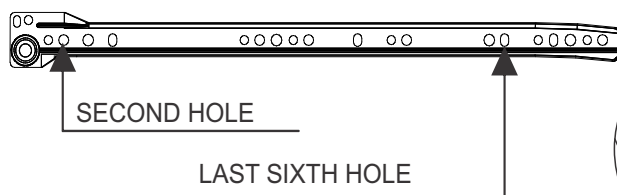
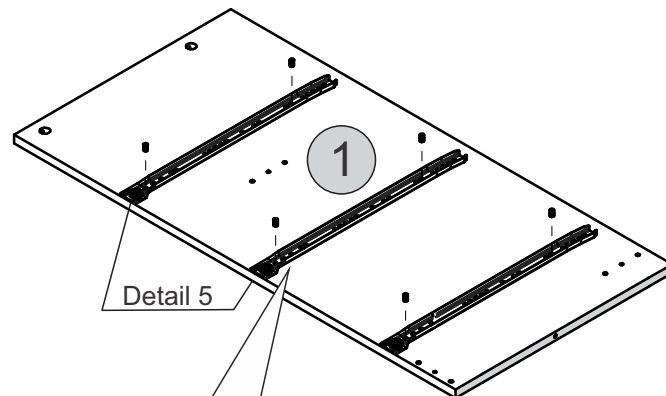
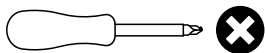

Detail 5

# STEP 5

## PARTS REQUIRED

5 - DIVISION PANEL x1

## HARDWARE REQUIRED

I  06

T  Right 03

T  Left 03

## TOOLS REQUIRED

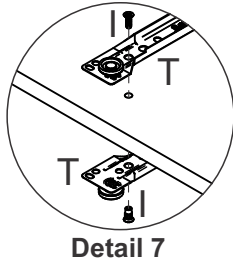
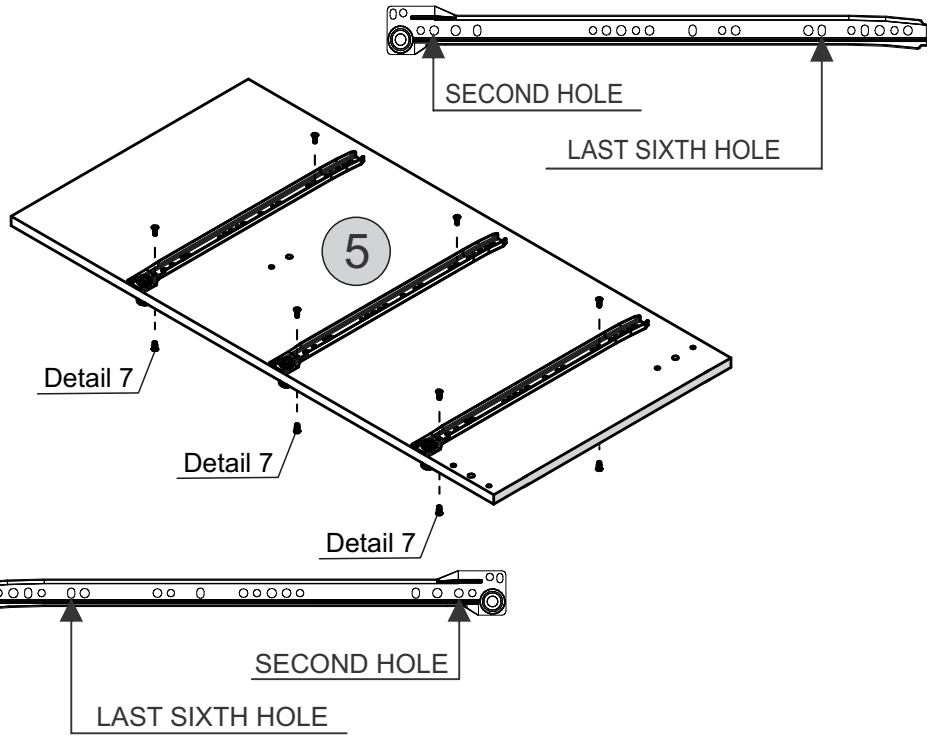
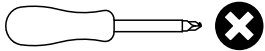

# STEP 6

## PARTS REQUIRED

5 - DIVISION PANEL x1

## HARDWARE REQUIRED

F  Ø6,0 x 30mm 02

H  02

N  02

P  Glue 01

## TOOLS REQUIRED

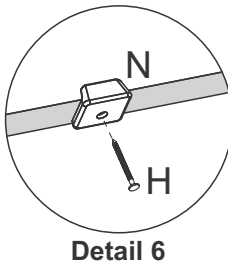
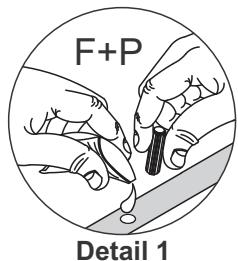
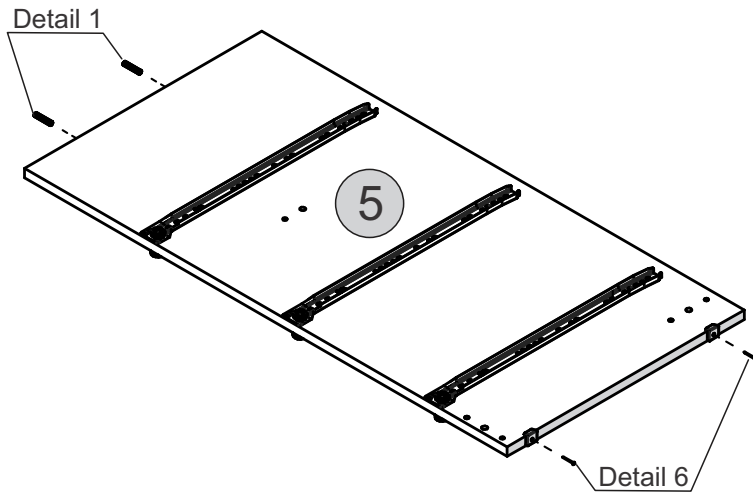
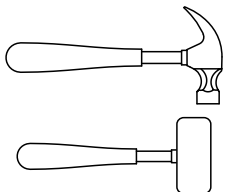

# STEP 7

## PARTS REQUIRED

1 - LEFT SIDE PANEL x1

6 - RIGHT SIDE PANEL x1

## HARDWARE REQUIRED

F  04  
Ø6,0 x 30mm

H  04

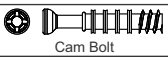
J  06  
Cam Bolt

N  04

P  01  
Glue

## TOOLS REQUIRED

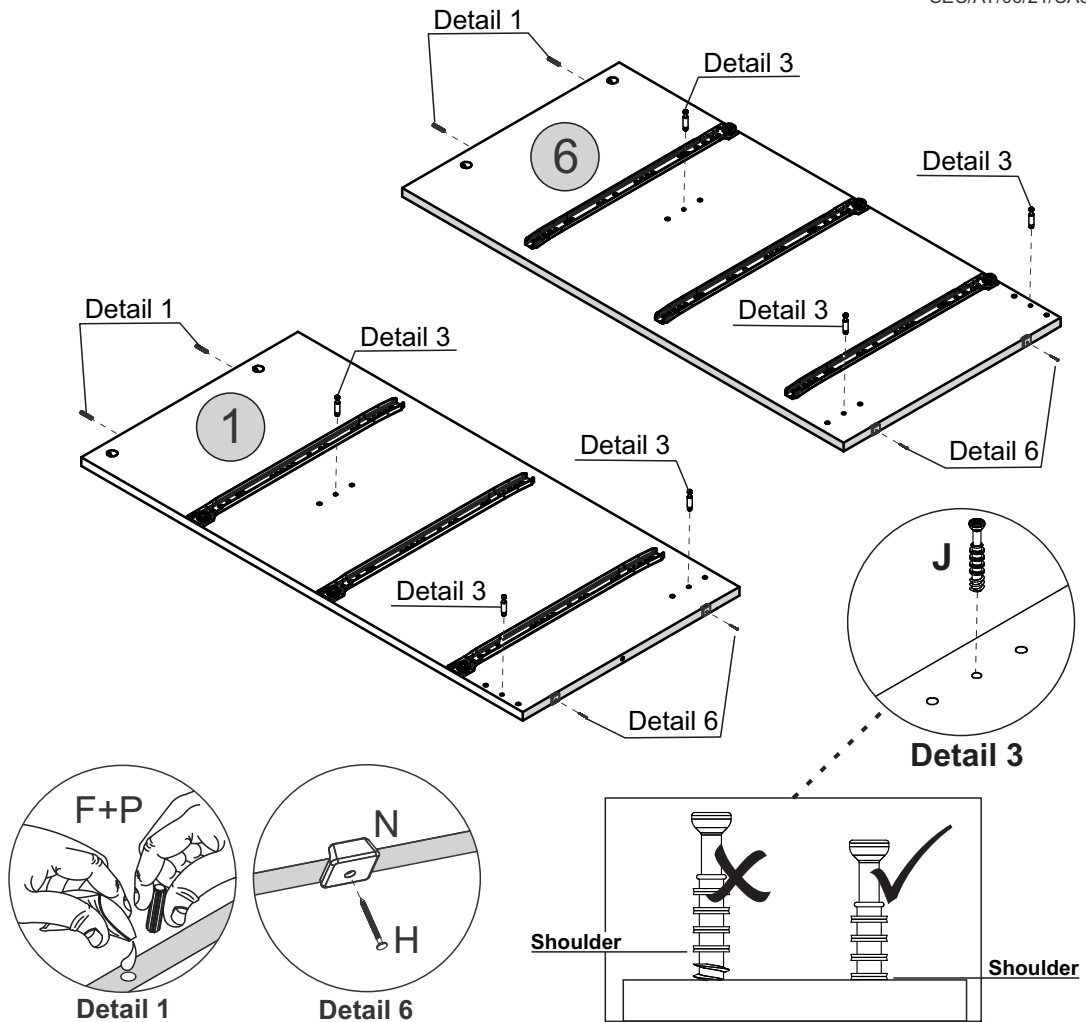
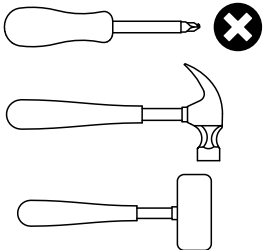

# STEP 8

## PARTS REQUIRED

2 - BACK BASEBOARD x2

3 - FRONT BASEBOARD x2

4 - CROSSBAR x2

5 - DIVISION PANEL x1

## HARDWARE REQUIRED

K  03

L  06

P  01  
Glue

## TOOLS REQUIRED

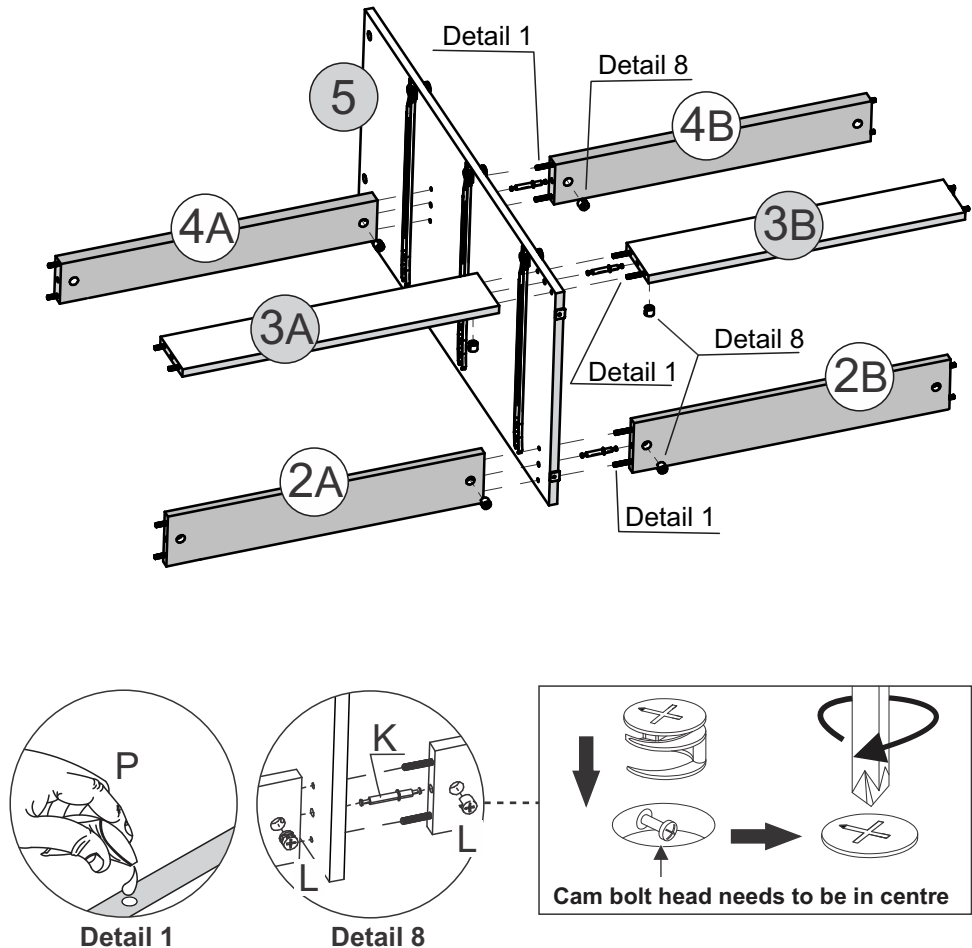
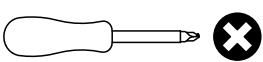

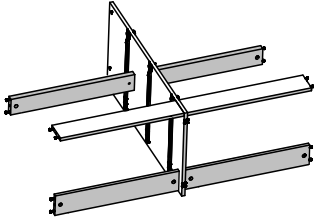

# STEP 9

## PARTS REQUIRED



- 1 - LEFT SIDE PANEL x1
- 6 - RIGHT SIDE PANEL x1

## HARDWARE REQUIRED

- L  06
- P  01

## TOOLS REQUIRED

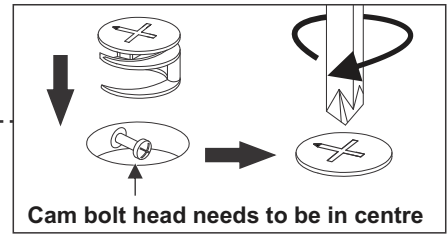
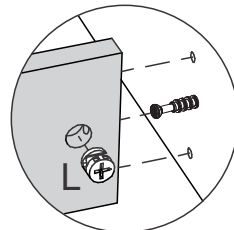
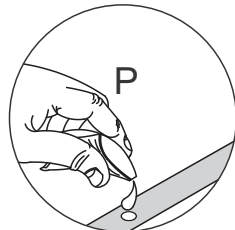
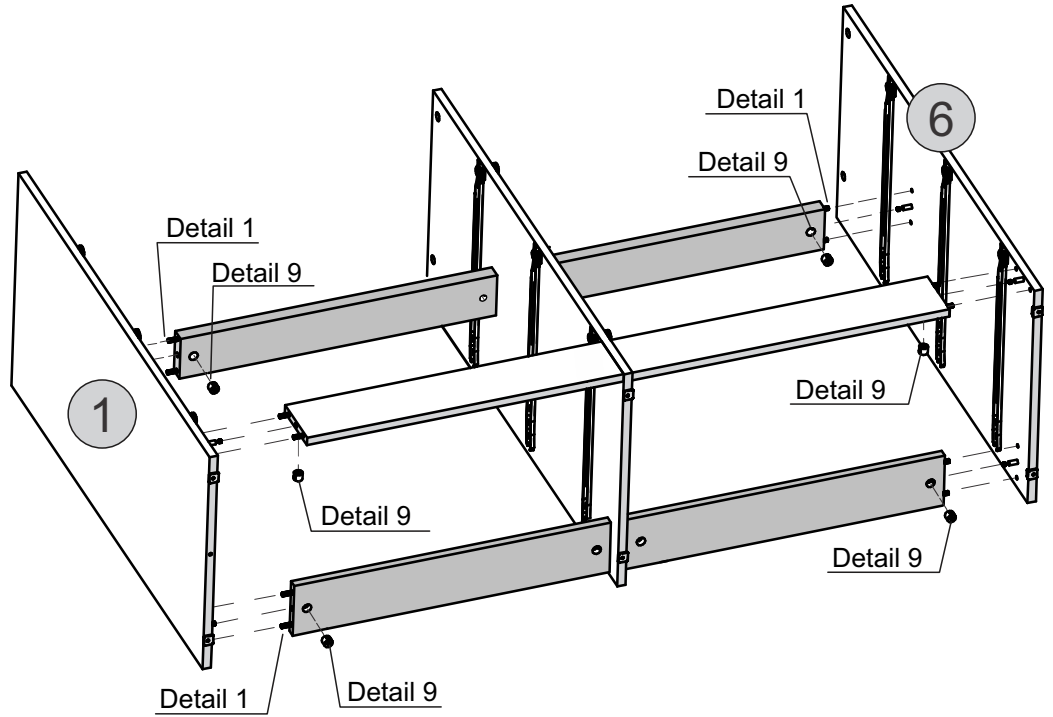
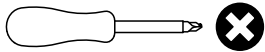

Detail 1

Detail 9



# STEP 10

## PARTS REQUIRED

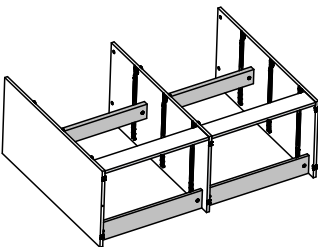
- 7 - TOP PANEL x1



## HARDWARE REQUIRED

- L  06
- P  01

## TOOLS REQUIRED

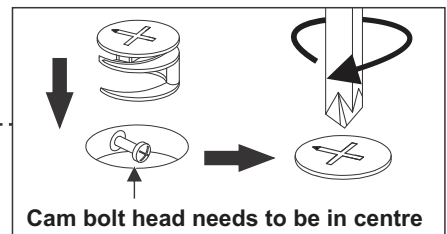
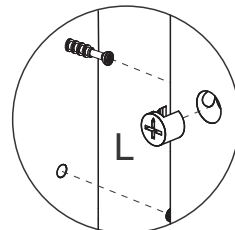
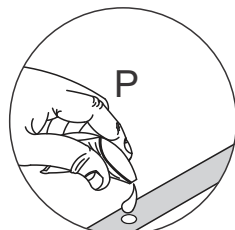
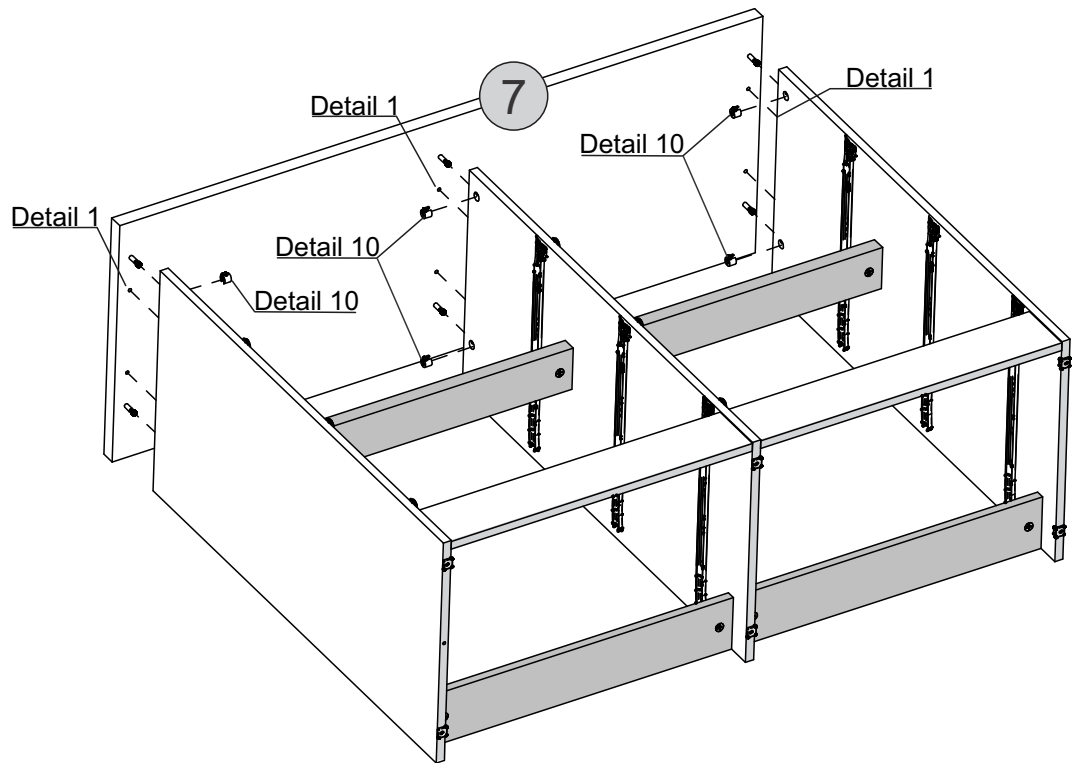
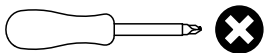

Detail 1

Detail 10



# STEP 11

## PARTS REQUIRED

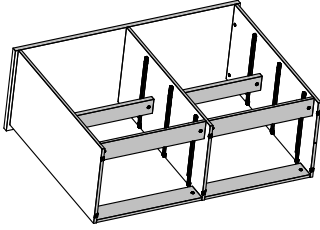

8 - BACK PANEL x2

## HARDWARE REQUIRED

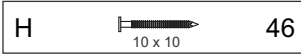

## TOOLS REQUIRED

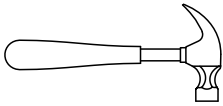

\* For your future reference  
Order Number should be here

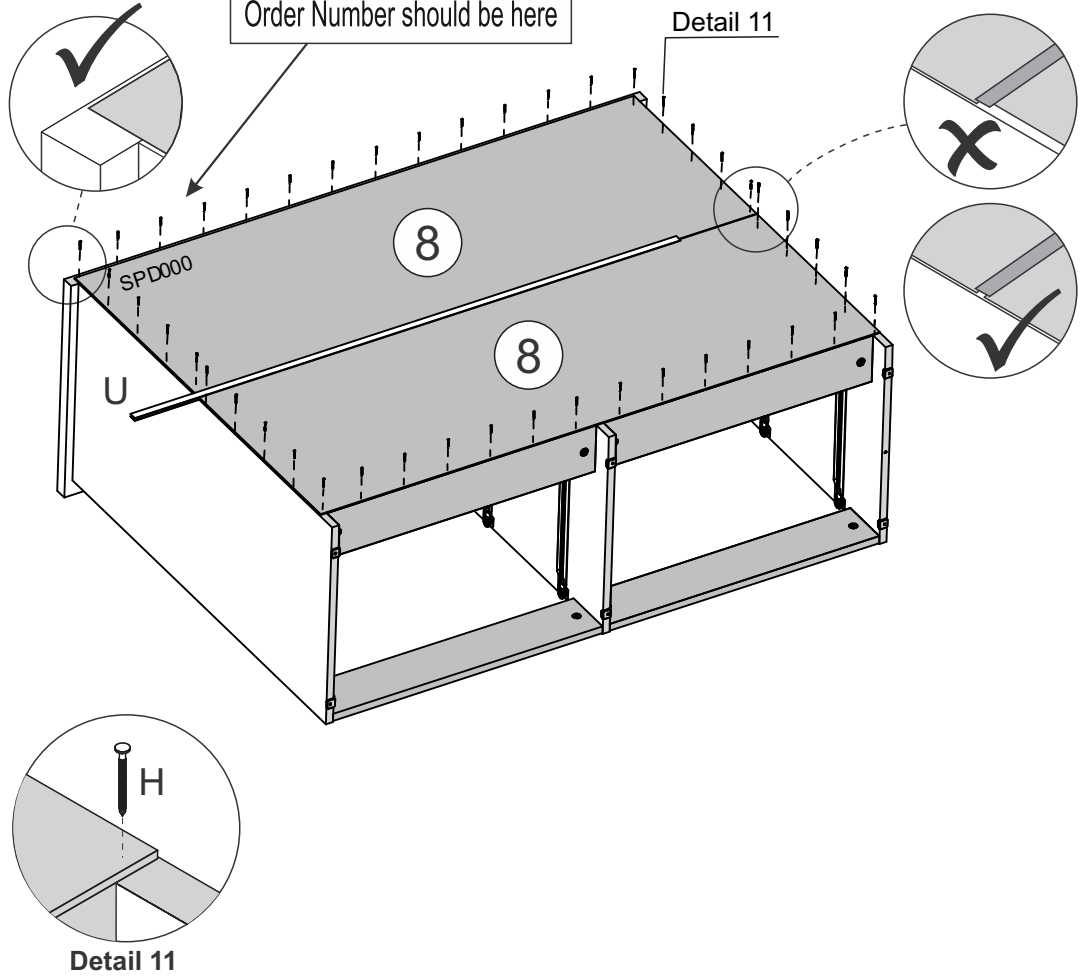

# STEP 12

## PARTS REQUIRED

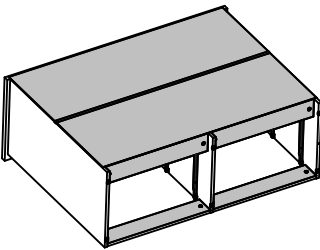

## HARDWARE REQUIRED

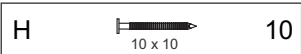

## TOOLS REQUIRED

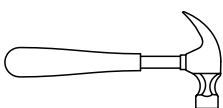

\* For your future reference  
Order Number should be here

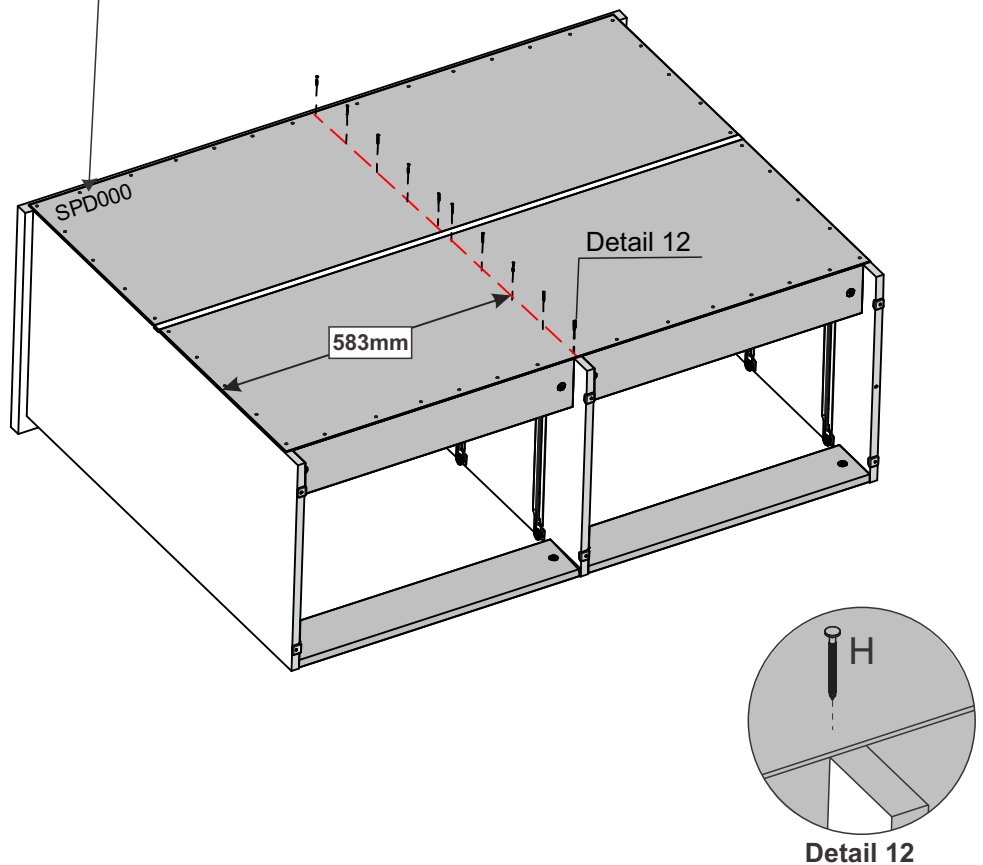

# STEP 13

## PARTS REQUIRED

11 - DRAWER FRONT x6

## HARDWARE REQUIRED

J  12

## TOOLS REQUIRED

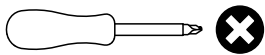

X6

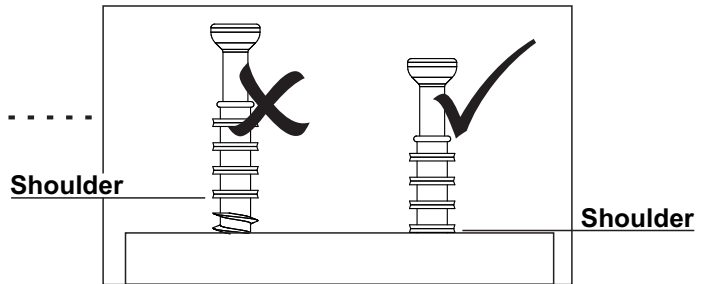
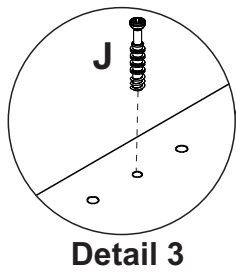
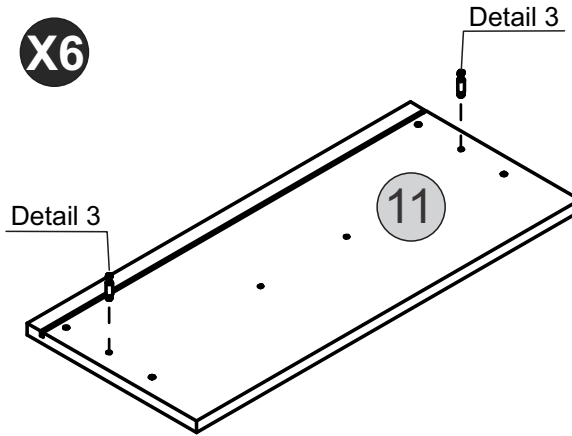

# STEP 14

## PARTS REQUIRED

9 - DRAWER BACK PANEL x6

10 - DRAWER SIDE x12

## HARDWARE REQUIRED

F  48  
Ø6,0 x 30mm

P  01  
Glue

## TOOLS REQUIRED

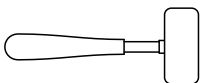

X12

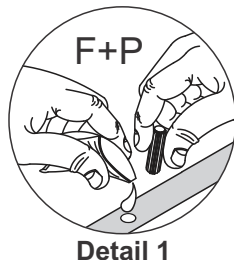
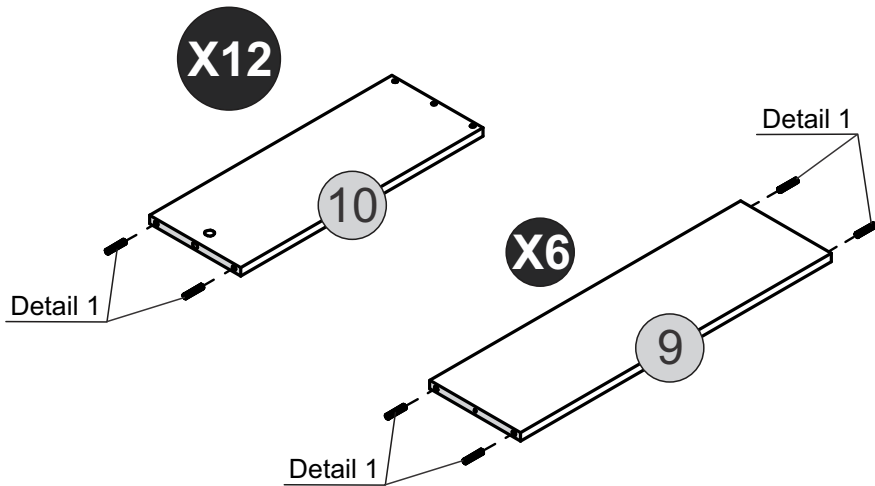

# STEP 15

## PARTS REQUIRED

9 - DRAWER BACK PANEL x6

10 - DRAWER SIDE x12

## HARDWARE REQUIRED

E  12  
Ø4.0 x 50mm

## TOOLS REQUIRED

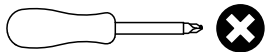

**X6**

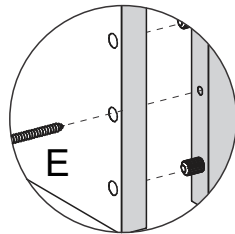
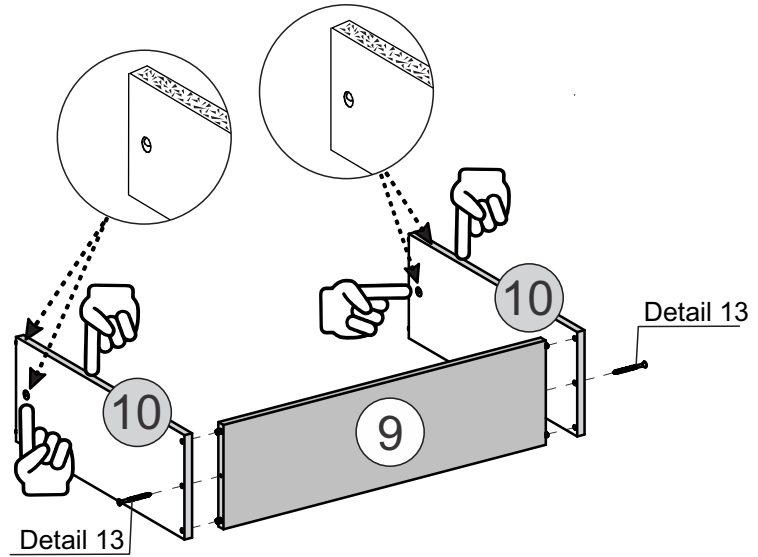

Detail 13

# STEP 16

## PARTS REQUIRED

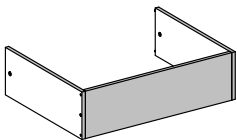

11 - DRAWER FRONT x6

## HARDWARE REQUIRED

M  12

O  12

P  01

## TOOLS REQUIRED

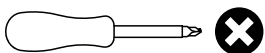

**X6**

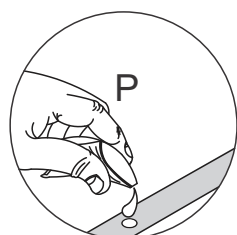
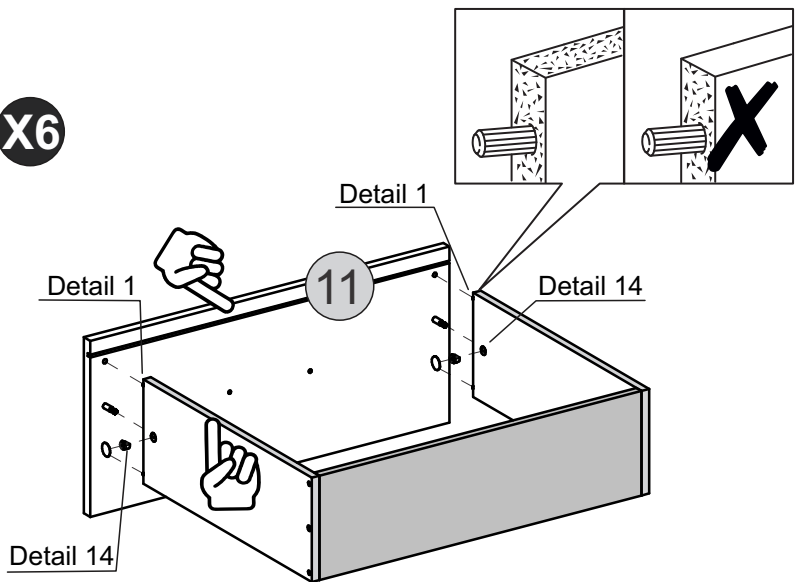

Detail 1

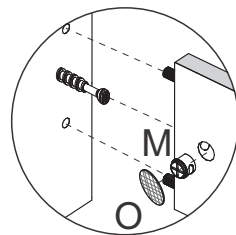

Detail 14

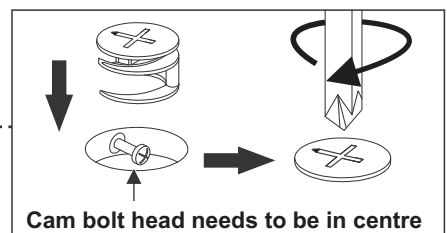

# STEP 17

**PARTS REQUIRED**

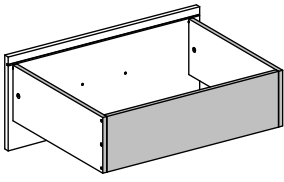

12 - DRAWER BOTTOM x6

**HARDWARE REQUIRED**

H  24  
10 x 10

**TOOLS REQUIRED**

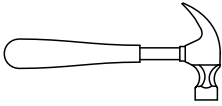

**X6**

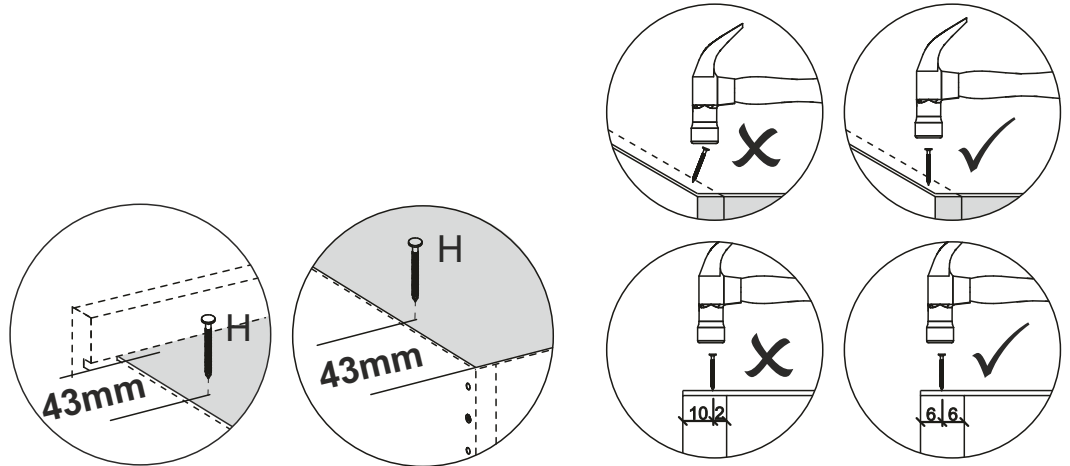
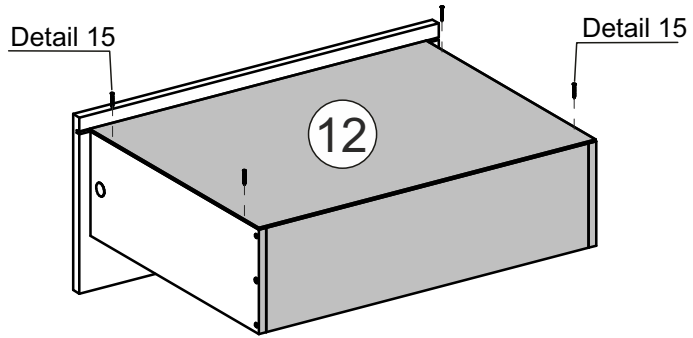

43mm

43mm

Detail 15

# STEP 18

**PARTS REQUIRED**

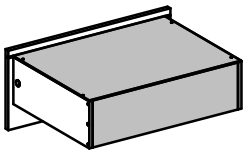

**HARDWARE REQUIRED**

H  30  
10 x 10

**TOOLS REQUIRED**

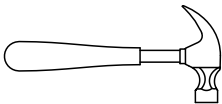

**X6**

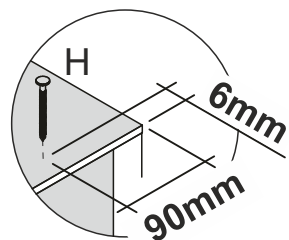
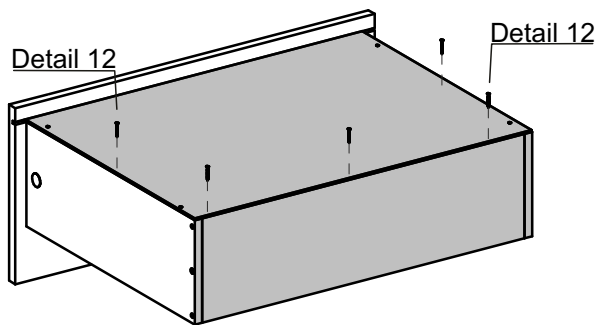

Detail 12

# STEP 19

**PARTS REQUIRED**

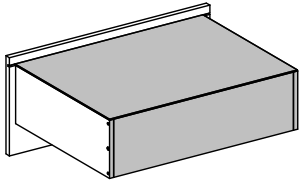

**HARDWARE REQUIRED**

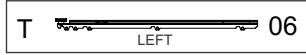
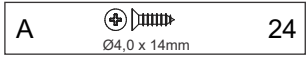

**TOOLS REQUIRED**

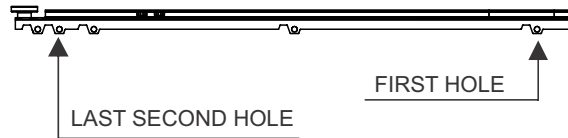
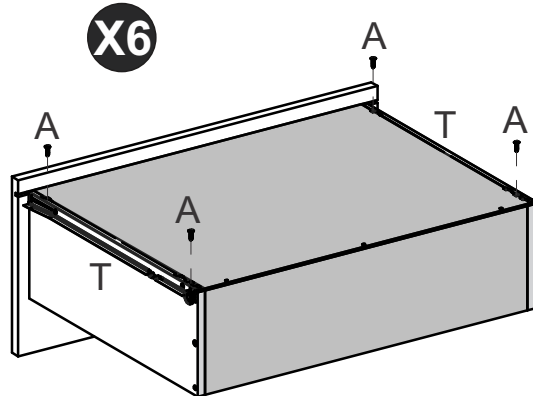
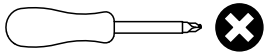

# STEP 20

**PARTS REQUIRED**

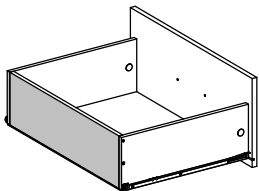

**HARDWARE REQUIRED**



**TOOLS REQUIRED**

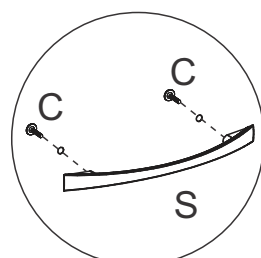
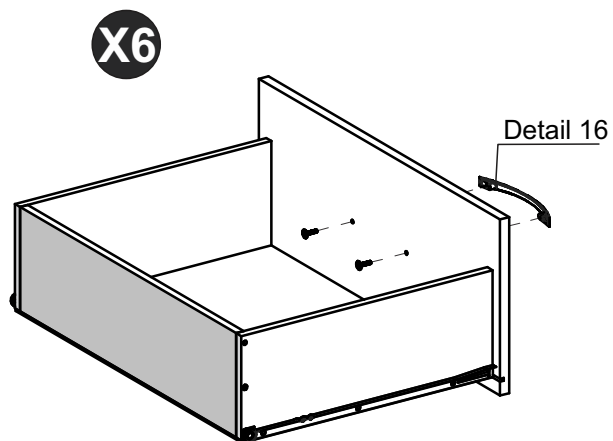
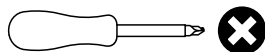

Detail 16

# STEP 21

## PARTS REQUIRED

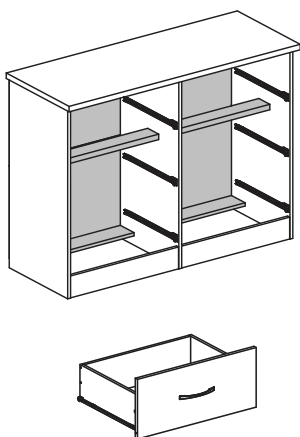

**TIP**  
If desired, after assembly use an alcohol cleaner to erase the number printed on the parts.

See the last page

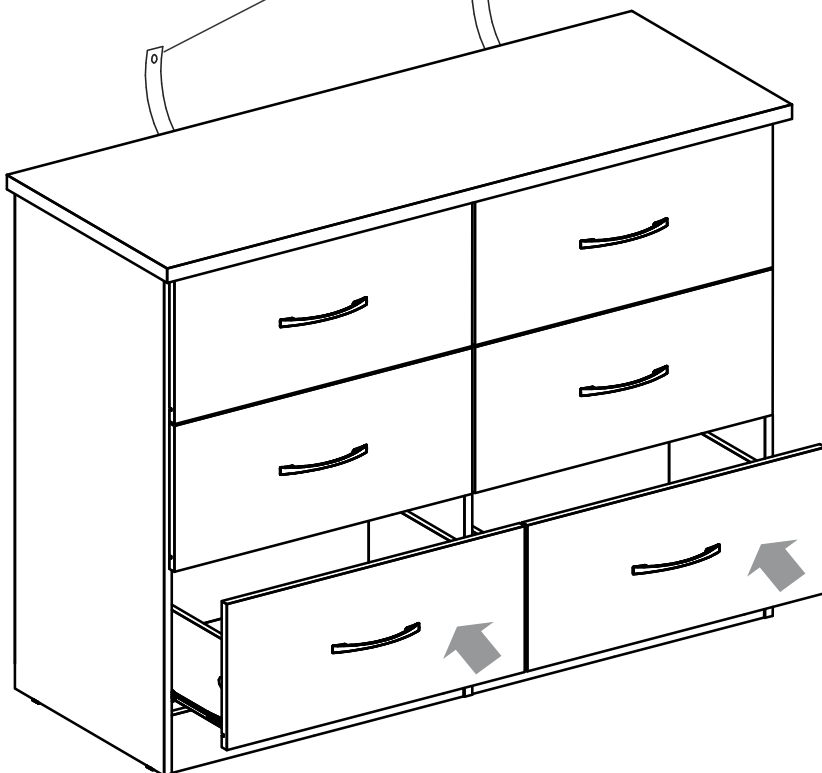

# STEP 22

## PARTS REQUIRED

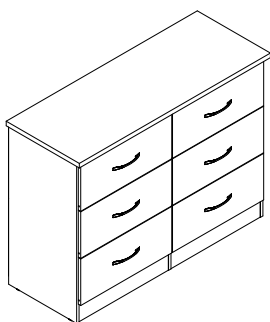

## HARDWARE REQUIRED

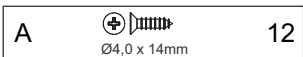

## TOOLS REQUIRED

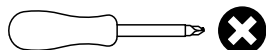

Detail 17

Detail 17

Detail 17

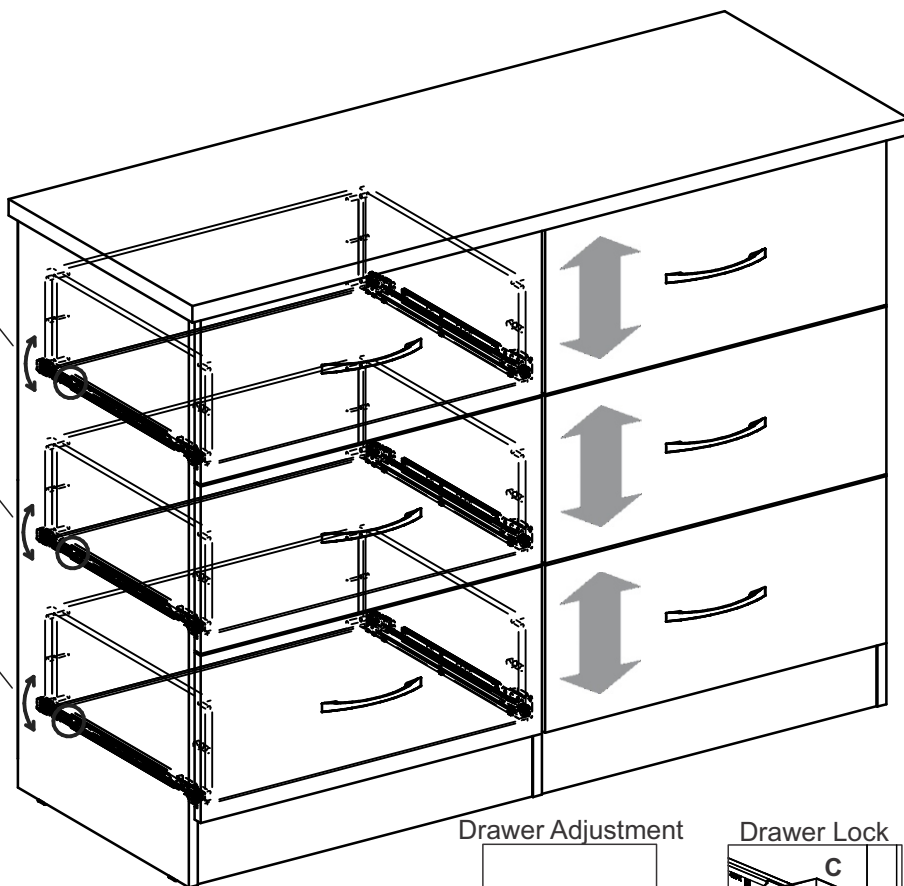

Drawer Adjustment

Drawer Lock

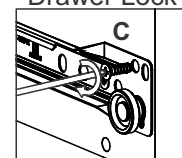
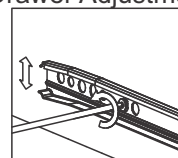

Detail 17

## WARNING

**Serious or fatal injuries can occur from furniture tipping over. To prevent the furniture from tipping over we recommend that it is permanently fixed to the wall.**

Wall fixings are not supplied with this product as different wall materials require different types of fixing devices.

Please make sure you use fixings suitable for the walls in your home.

