

# NEVADA 5 DRAWER NARROW CHEST ASSEMBLY INSTRUCTIONS 3D EFFECT GREY

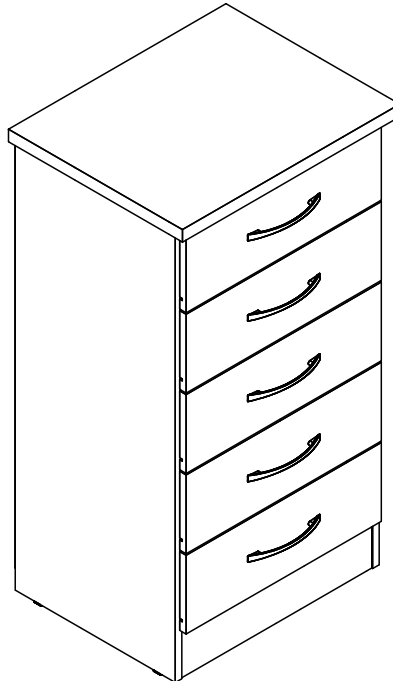

**IMPORTANT**  
**FOR DOMESTIC USE ONLY**  
PLEASE READ BEFORE YOU CONTINUE FURTHER

## CARE AND MAINTENANCE

- After unpacking this product please keep the original packaging in case it needs to be returned for any reason.
- Please ensure all fittings and parts are present before commencing with assembly.
  - Never drag or push products as this could cause damage to the joints making it inferior.
  - We strongly recommend that you keep children away from your work area.
  - We recommend that you lay a blanket or sheet on the floor to avoid damage to both your floor and the product.
  - Assemble this product as close to its final position as possible.
  - Do not place this product next to a radiator or in direct sunlight.
  - Do not drag or push items across your high gloss furniture as this may cause the surface to scratch
  - Wood is a natural product and may expand if subjected to damp and may shrink or crack if subjected to heat. Therefore it is recommended that room temperature is maintained, with no sudden temperature fluctuations.
  - Make sure any spillage is wiped off immediately.
  - Do not place hot or chilled items directly on to the surface, use a place mat or marking will occur.
  - For general cleaning use a soft cotton or micro fibre cloth, and do not use detergents of any kind.
  - From time to time it may be necessary to tighten fittings, regular inspections should be carried out.
  - Do not place on a wet or damp floor as staining may occur to your floor.

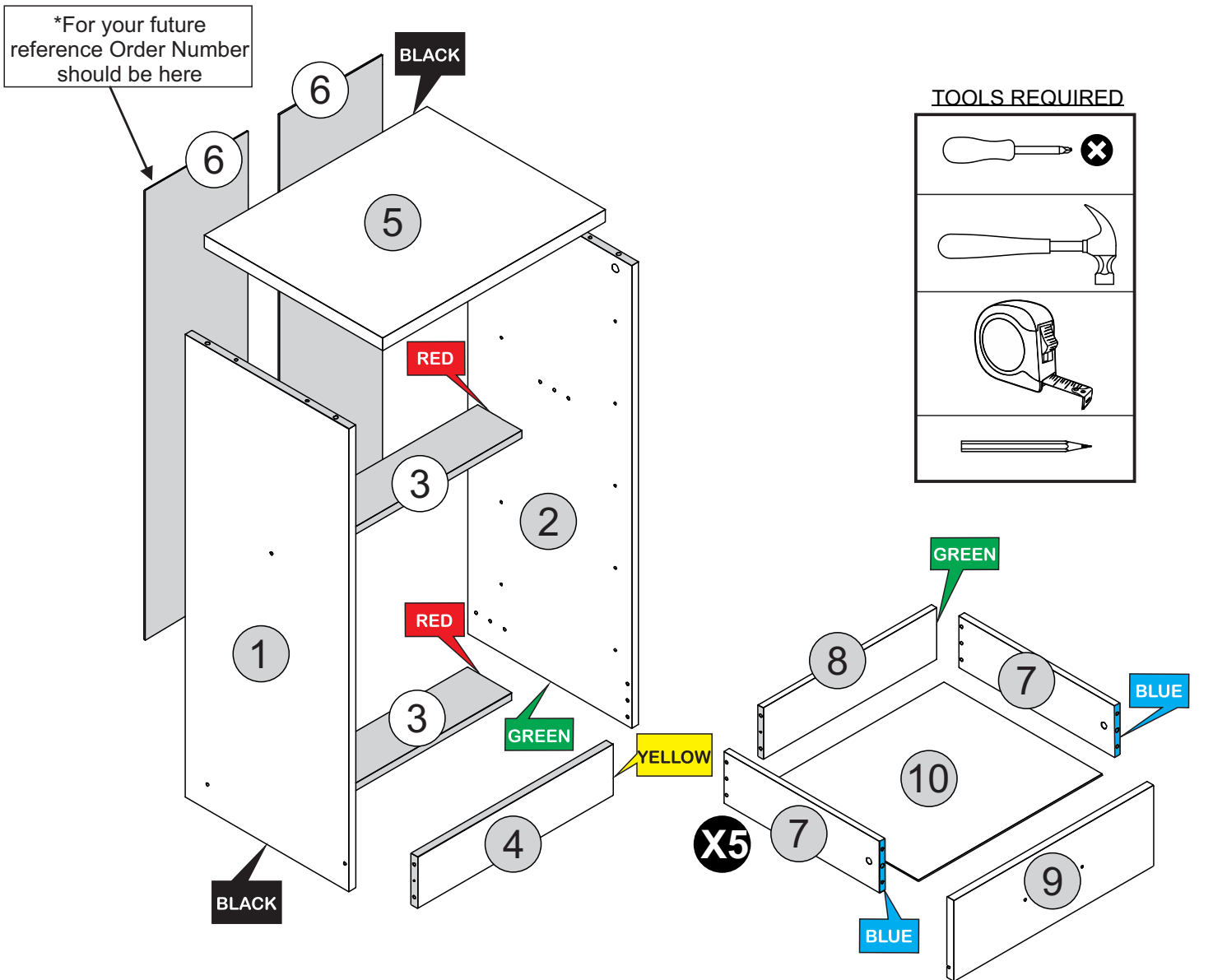









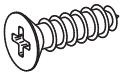
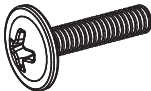
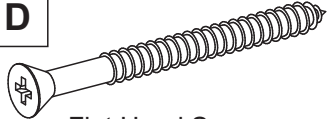

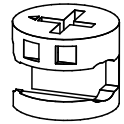

### PARTS LIST

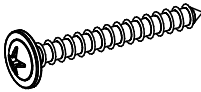
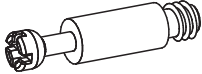
**Please Note:**  
The below parts have all been stamped with the part number/color to help identify them during assembly.

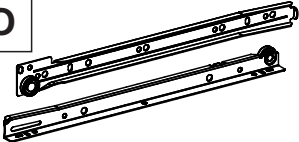
Part Numer/Color	Part Code	Part Description	Quantity	Carton
1	S100-102-152-SP1-01	Left Side Panel - <b>BLACK</b>	1	1/1
2	S100-102-152-SP1-02	Right Side Panel - <b>GREEN</b>	1	1/1
3	S100-102-152-SP1-03	Back Baseboard - <b>RED</b>	2	1/1
4	S100-102-152-SP1-04	Front Baseboard - <b>YELLOW</b>	1	1/1
5	S100-102-152-SP1-05	Top Panel - <b>BLACK</b>	1	1/1
6	S100-102-152-SP1-06	Back Panel	2	1/1
7	S100-102-152-SP1-07	Drawer Side - <b>BLUE</b>	10	1/1
8	S100-102-152-SP1-08	Drawer Back Panel - <b>GREEN</b>	5	1/1
9	S100-102-152-SP1-09	Drawer Front	5	1/1
10	S100-102-152-SP1-10	Drawer Botom	5	1/1

### FITTINGS LIST

<p><b>A</b></p>  <p>Flat Head Screw 2/+ Ø6,0 x 10mm (20x)</p>	<p><b>B</b></p>  <p>Flat Head Screw 2/+ Ø4,0 x 14mm (30x)</p>	<p><b>C</b></p>  <p>Flan Head Screw 2/+ Ø4,0 x 22mm (10x)</p>	<p><b>D</b></p>  <p>Flat Head Screw 2/+ Ø4,0 x 50mm (16x)</p>
<p><b>E</b></p>  <p>2/+ Dowel Ø6,0 x 30mm (56x)</p>	<p><b>F</b></p>  <p>2/+ Nail 10 x 10 (74x)</p>	<p><b>G</b></p>  <p>2/+ Cam Nut Ø12mm (10x)</p>	<p><b>H</b></p>  <p>1/+ Cam Nut Ø15mm (4x)</p>
<p><b>I</b></p>  <p>1/+ Washer (2x)</p>	<p><b>J</b></p>  <p>1/+ Plastic Foot (4x)</p>	<p><b>K</b></p>  <p>1/+ Flan Head Screw Ø3,5 x 30mm (1x)</p>	<p><b>L</b></p>  <p>2/+ Cam Bolt (14x)</p>
<p><b>M</b></p>  <p>2/+ Hole Plugs (16x)</p>	<p><b>N</b></p>  <p>Glue (2x)</p>	<p><b>O</b></p>  <p>Drawer Runners (5x)</p>	<p><b>P</b></p>  <p>Back Panel Strip (1x)</p>
<p><b>Q</b></p>  <p>Strap (1x)</p>	<p><b>R</b></p>  <p>Handle (5x)</p>		

### TIPS FOR FITTINGS CAM-LOCKS

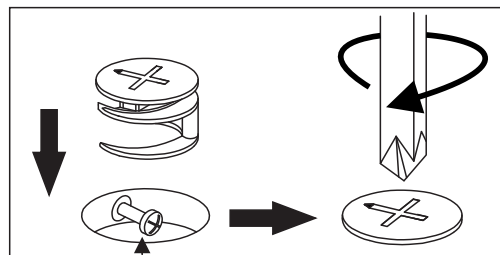
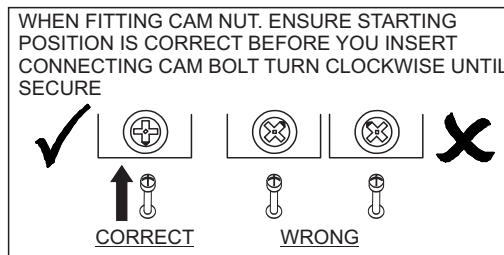

Cam bolt head needs to be in centre

#### CAMBOLT

Tighten until shoulder in flush with panel. Do not overtighten or undertighten (see example below)

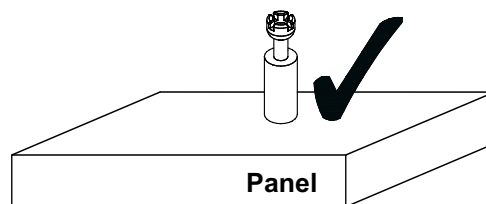
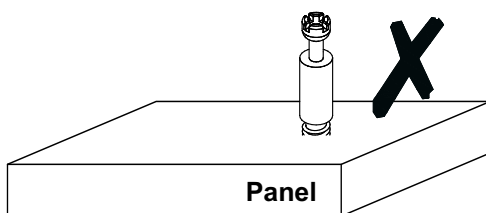
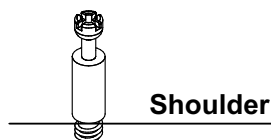

# STEP 1

## PARTS REQUIRED

1 - LEFT SIDE PANEL (BLACK) x1

## HARDWARE REQUIRED

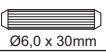
E  02  
Ø6,0 x 30mm

F  02  
10 x 10

J  02

N  01

## TOOLS REQUIRED

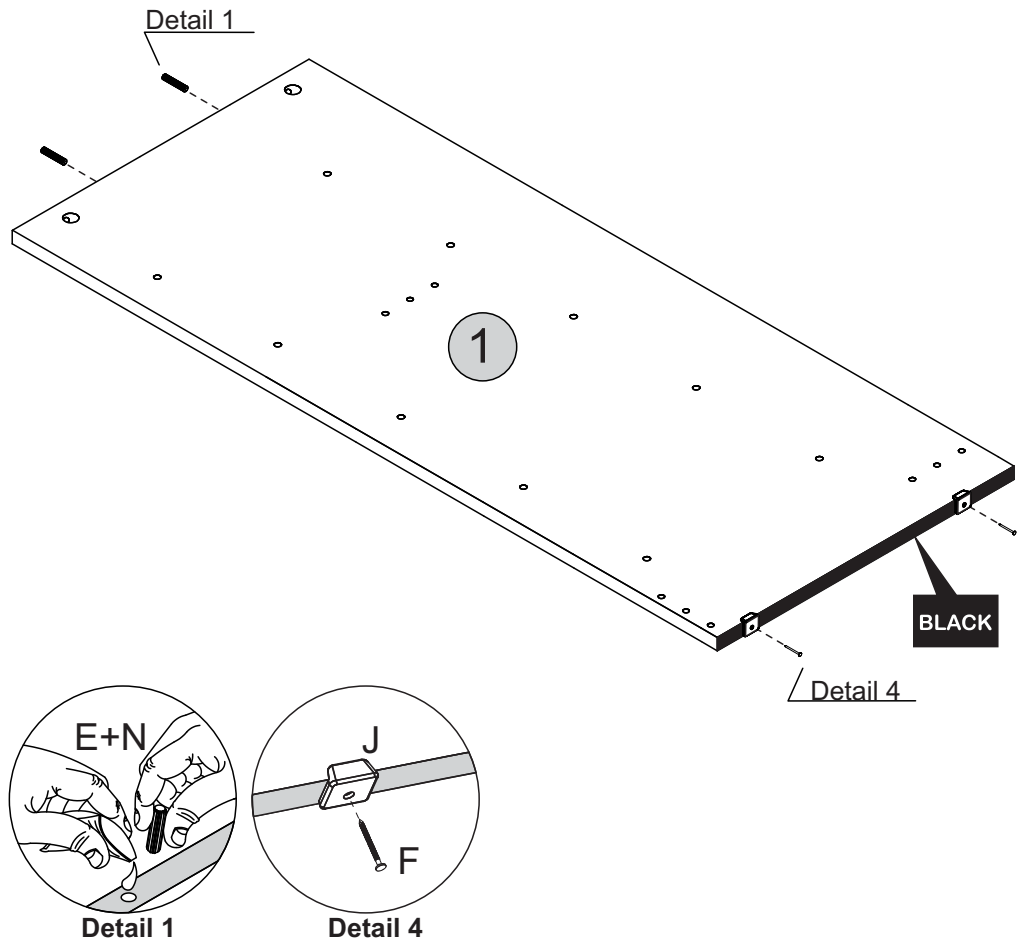
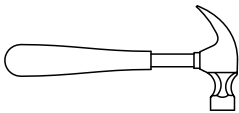

# STEP 2

## PARTS REQUIRED

2 - RIGHT SIDE PANEL (GREEN) x1

## HARDWARE REQUIRED

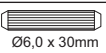
E  02  
Ø6,0 x 30mm

F  02  
10 x 10

J  02

N  01

## TOOLS REQUIRED

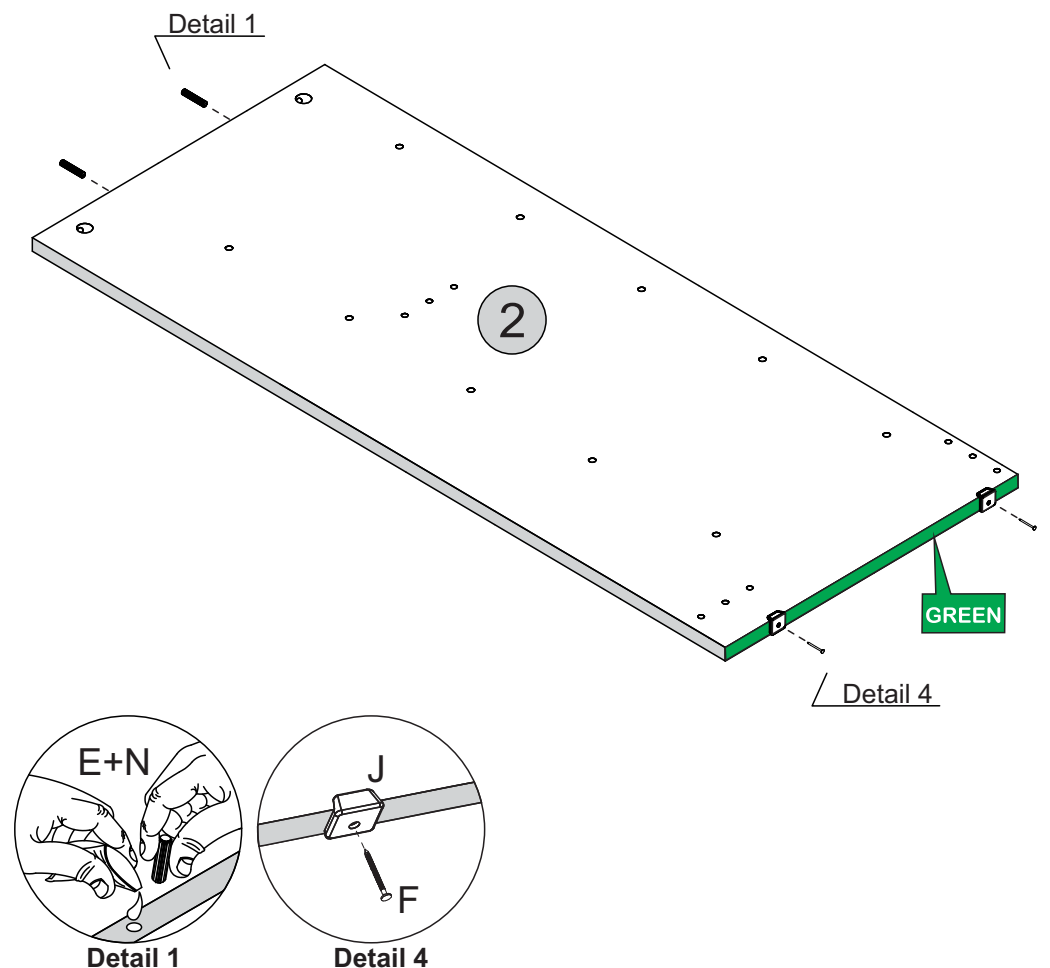
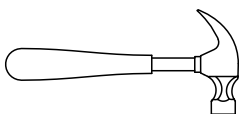

# STEP 3

## PARTS REQUIRED

2 - RIGHT SIDE PANEL (GREEN)x1

## HARDWARE REQUIRED

A  10  
Ø6.0 x 10mm

B  05  
Ø4.0 x 14mm

O  05  
RIGHT

## TOOLS REQUIRED

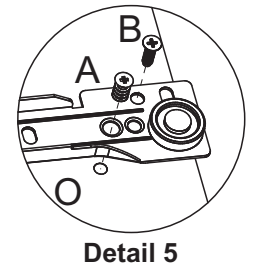
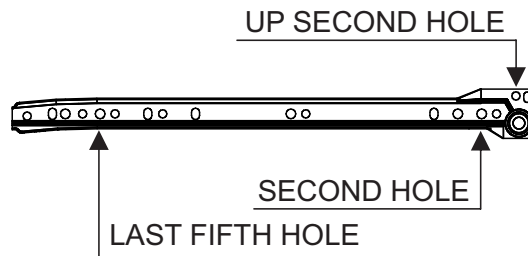
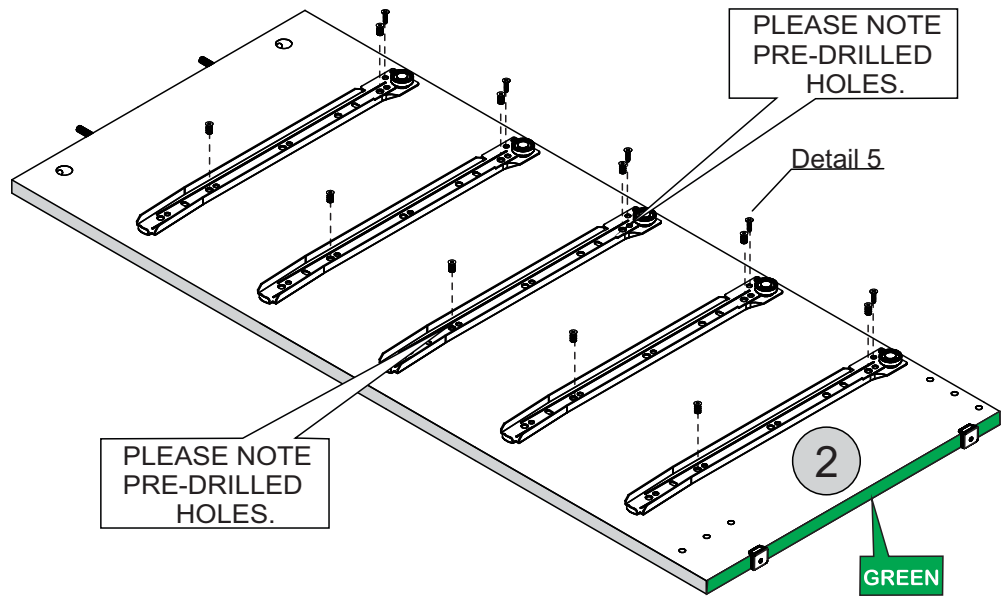
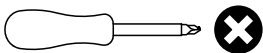

# STEP 4

## PARTS REQUIRED

1 - LEFT SIDE PANEL (BLACK)x1

## HARDWARE REQUIRED

A  10  
Ø6.0 x 10mm

B  05  
Ø4.0 x 14mm

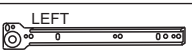
O  05  
LEFT

## TOOLS REQUIRED

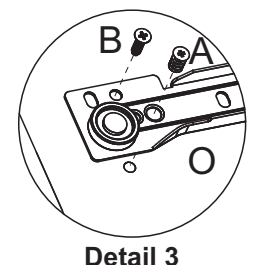
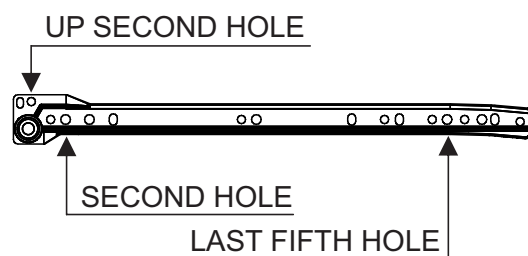
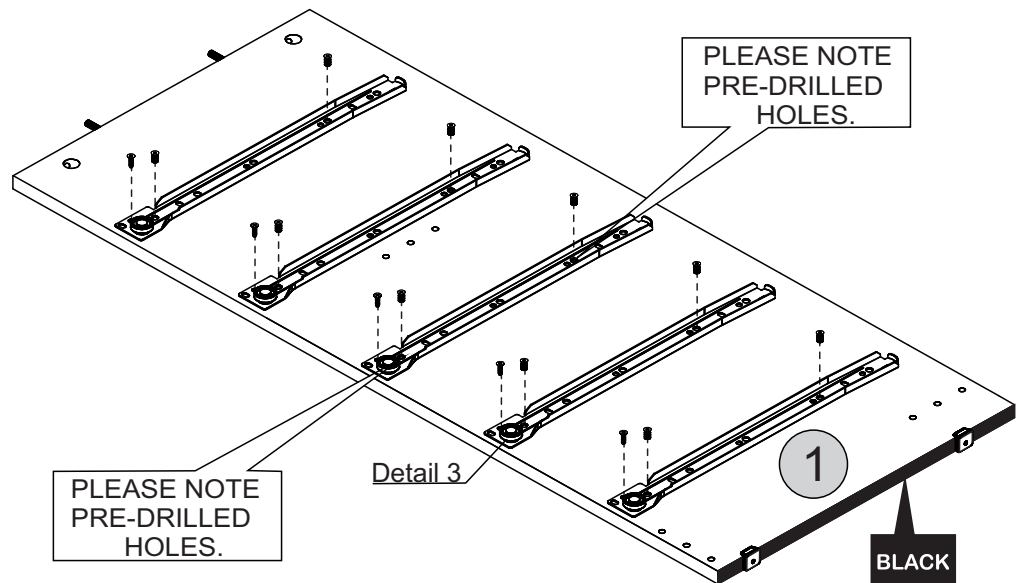
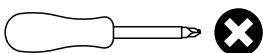

# STEP 5

## PARTS REQUIRED

3 - BACK BASEBOARD (RED) x2

4 - FRONT BASEBOARD (YELLOW) x1

## HARDWARE REQUIRED

E  12  
Ø6,0 x 30mm

N  01  
GLUE

## TOOLS REQUIRED

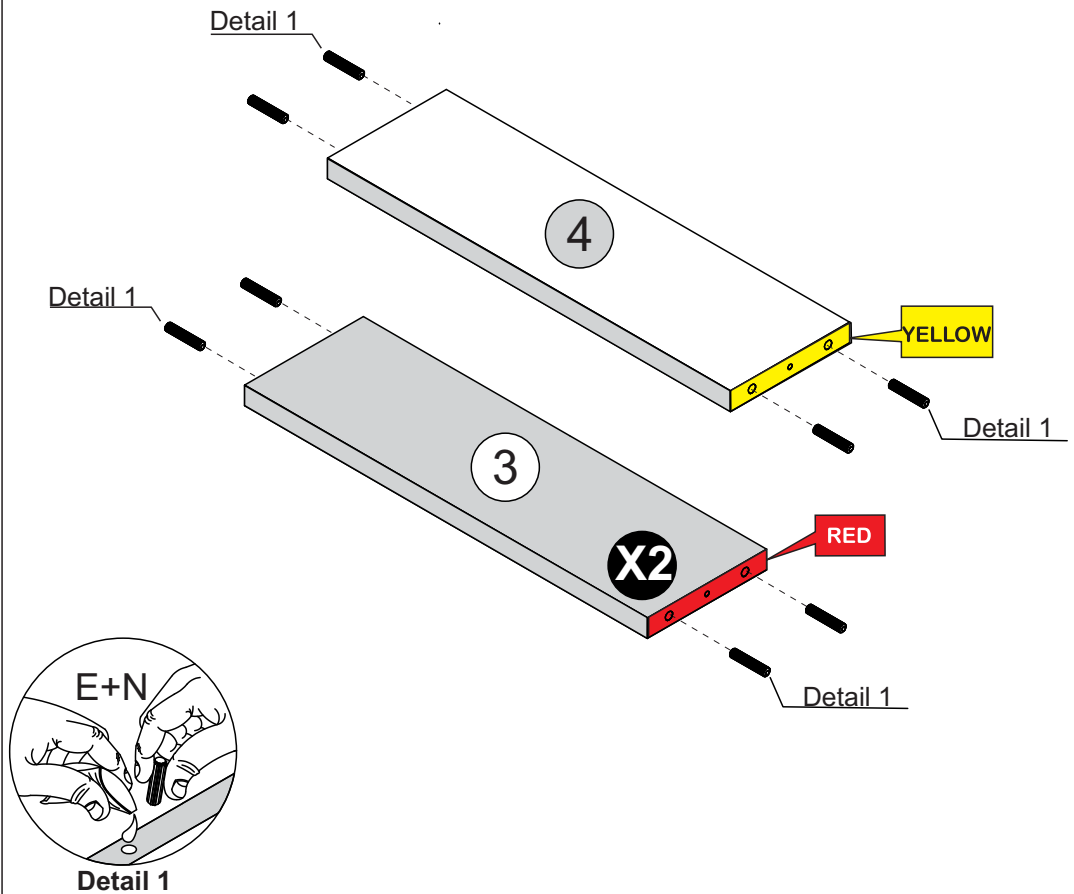

# STEP 6

## PARTS REQUIRED

2 - RIGHT SIDE PANEL (GREEN) x1

3 - BACK BASEBOARD (RED) x2

4 - FRONT BASEBOARD (YELLOW) x1

## HARDWARE REQUIRED

D  03  
Ø4,0 x 50mm

K  01  
GLUE

## TOOLS REQUIRED

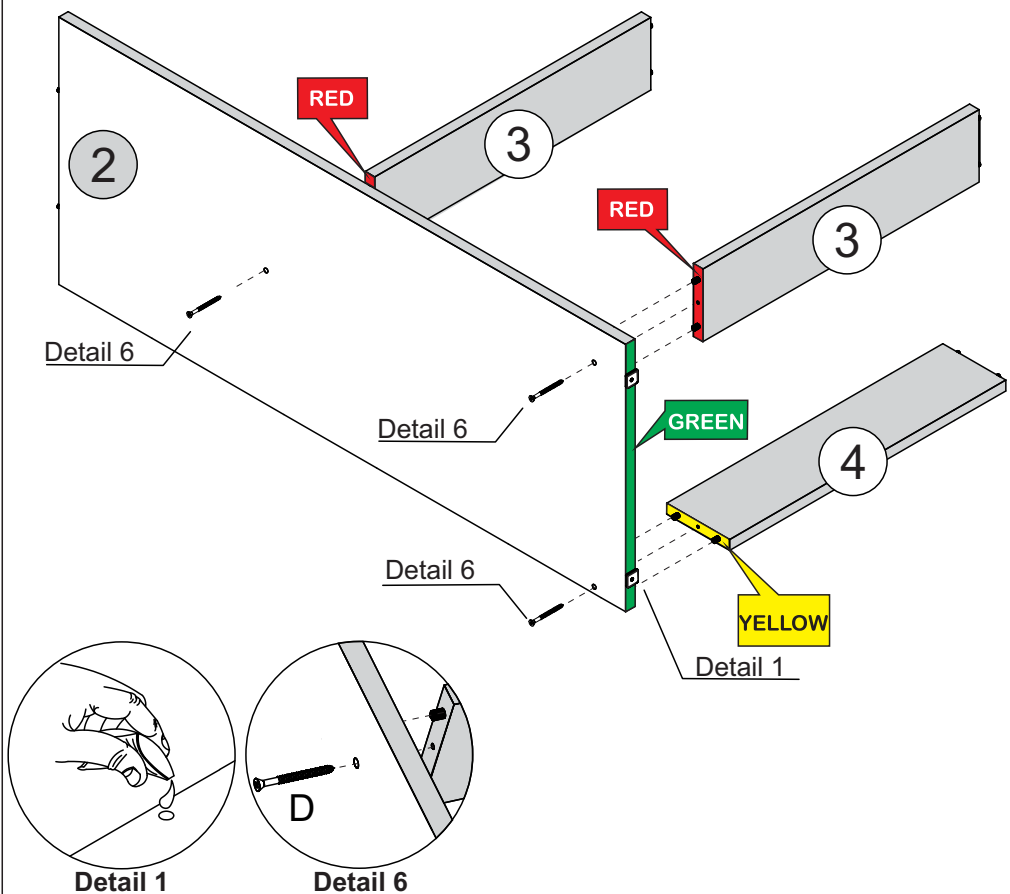
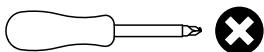

# STEP 7

## PARTS REQUIRED

1 - LEFT SIDE PANEL (BLACK) x1

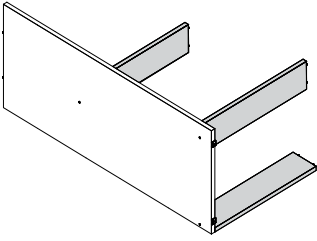

## HARDWARE REQUIRED

D  03  
Ø4.0 x 50mm

K  01  
GLUE

## TOOLS REQUIRED

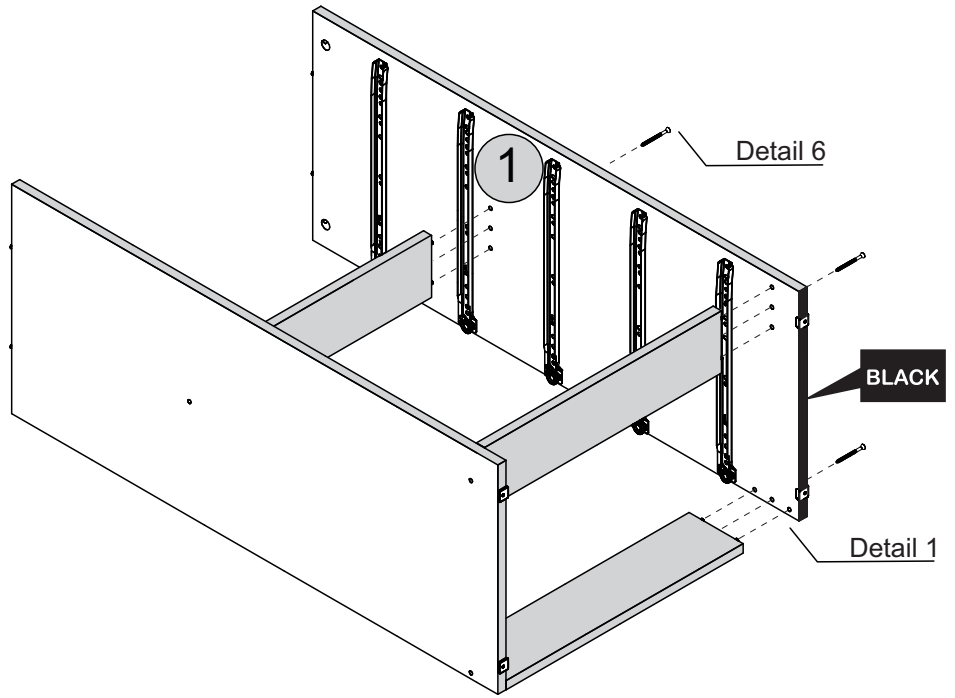
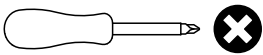

Detail 1

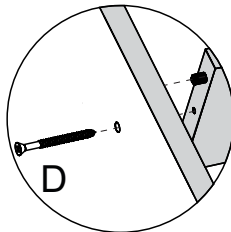

Detail 6

# STEP 8

## PARTS REQUIRED

5 - TOP PANEL (BLACK) x1

## HARDWARE REQUIRED

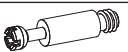
L  04

## TOOLS REQUIRED

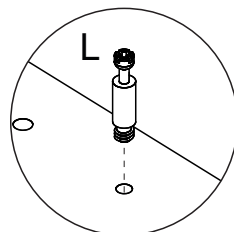
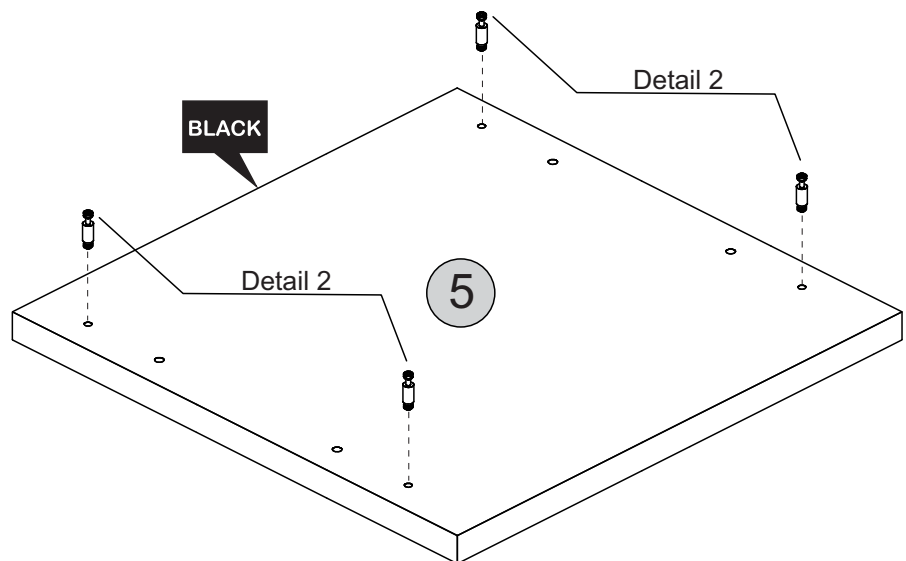
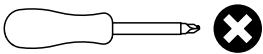

Detail 2

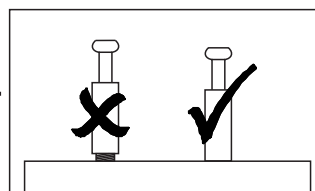

# STEP 9

## PARTS REQUIRED

5 - TOP PANEL (BLACK) x1

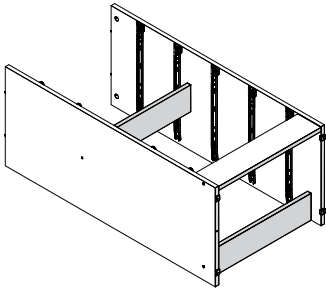

## HARDWARE REQUIRED

H  04

N  01

## TOOLS REQUIRED

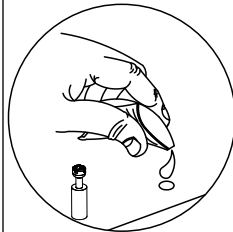
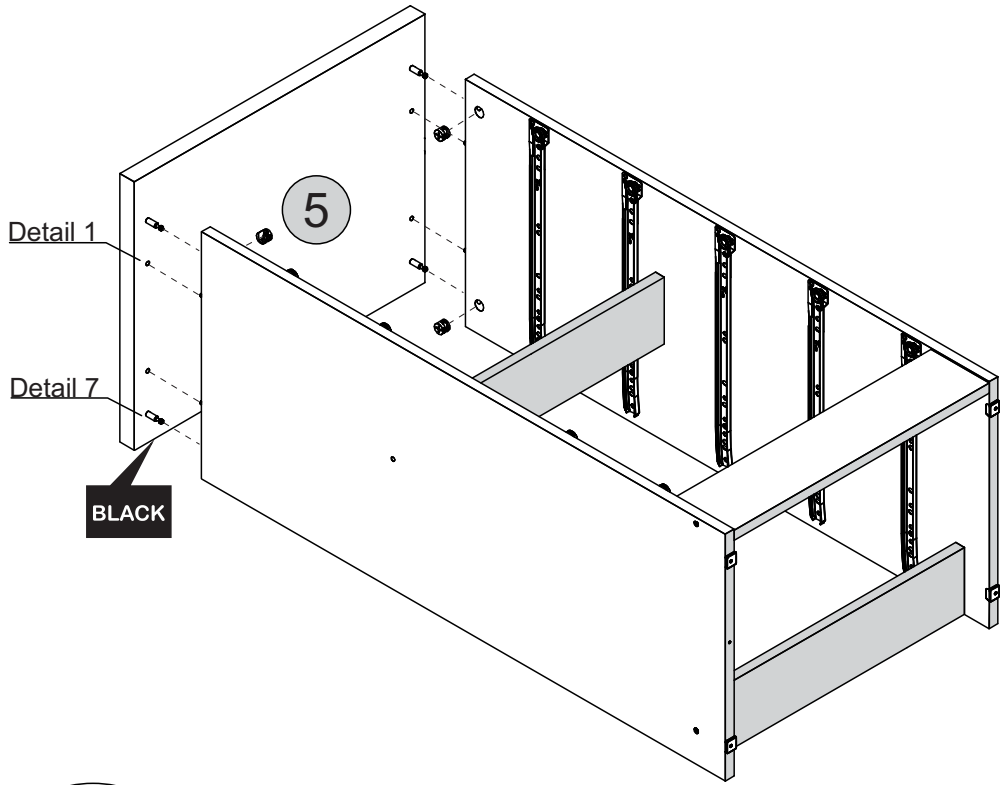
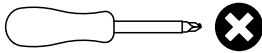

Detail 1

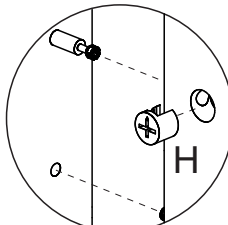

Detail 7

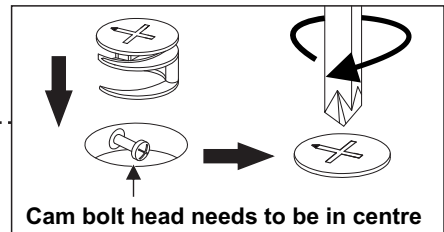

Cam bolt head needs to be in centre

# STEP 10

## PARTS REQUIRED

6 - BACK PANEL x2

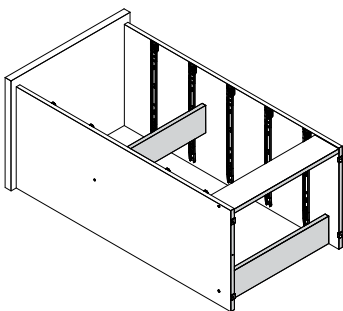

## HARDWARE REQUIRED

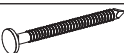
F  30

P  01

## TOOLS REQUIRED

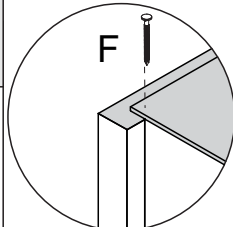
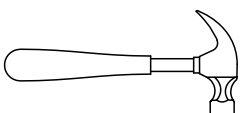

Detail 8

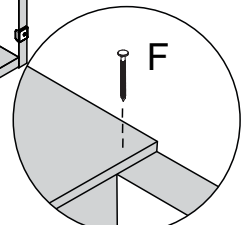
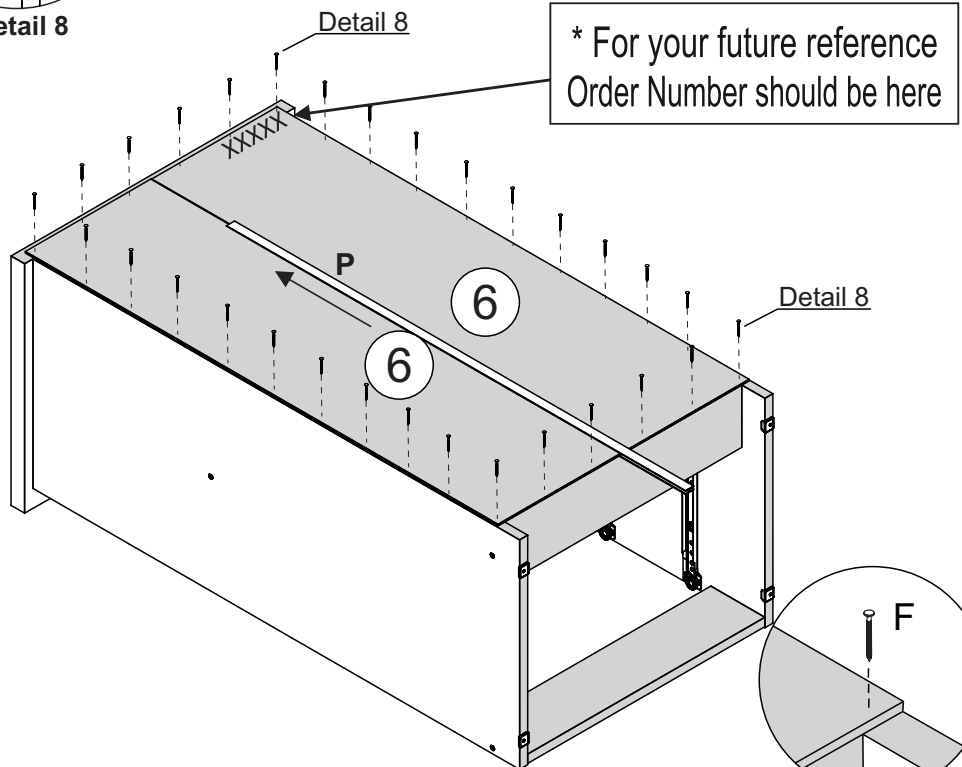
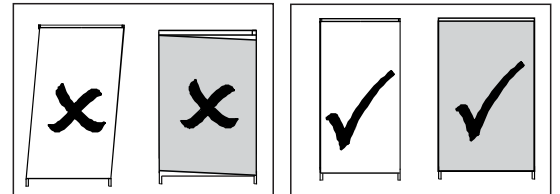

Detail 8



# STEP 11

## PARTS REQUIRED

7 - DRAWER SIDE (BLUE) x10

8 - DRAWER BACK PANEL (GREEN)x5

## HARDWARE REQUIRED

E  40  
Ø6,0 x 30mm

N  01

## TOOLS REQUIRED

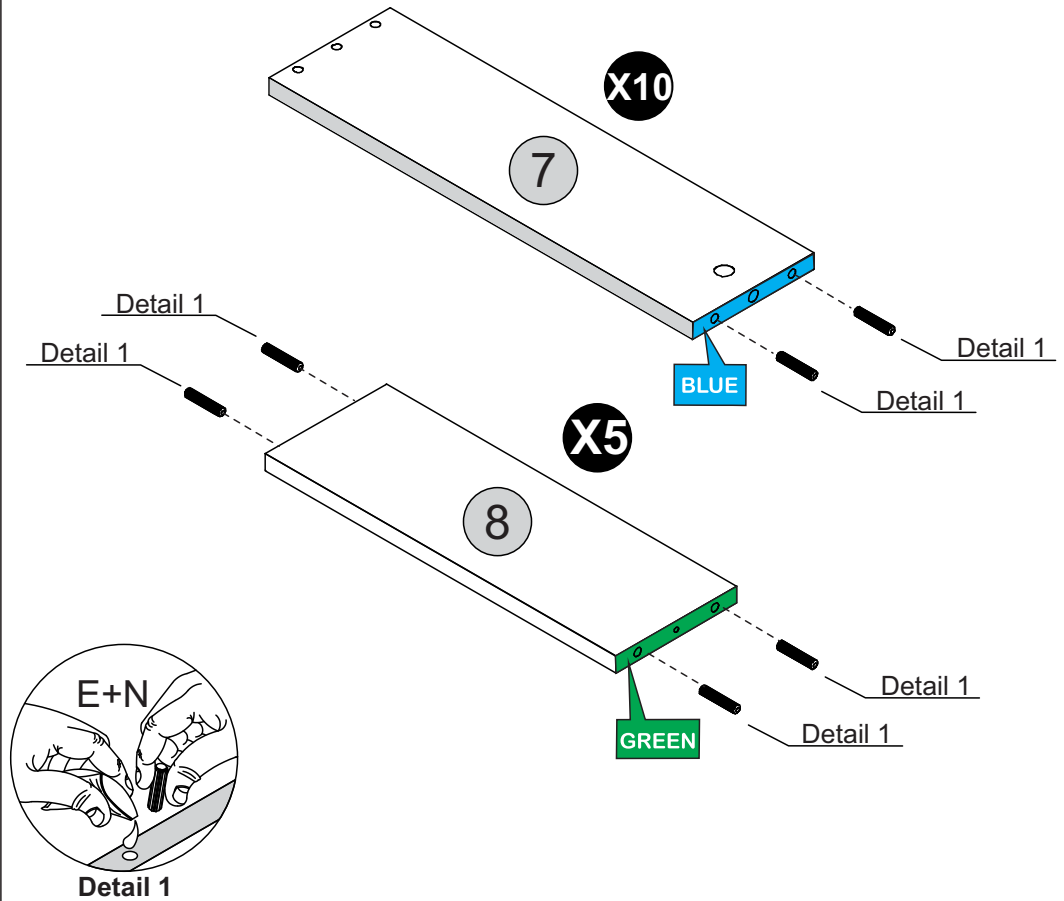

# STEP 12

## PARTS REQUIRED

9 - DRAWER FRONT x5

## HARDWARE REQUIRED

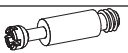
L  10

## TOOLS REQUIRED

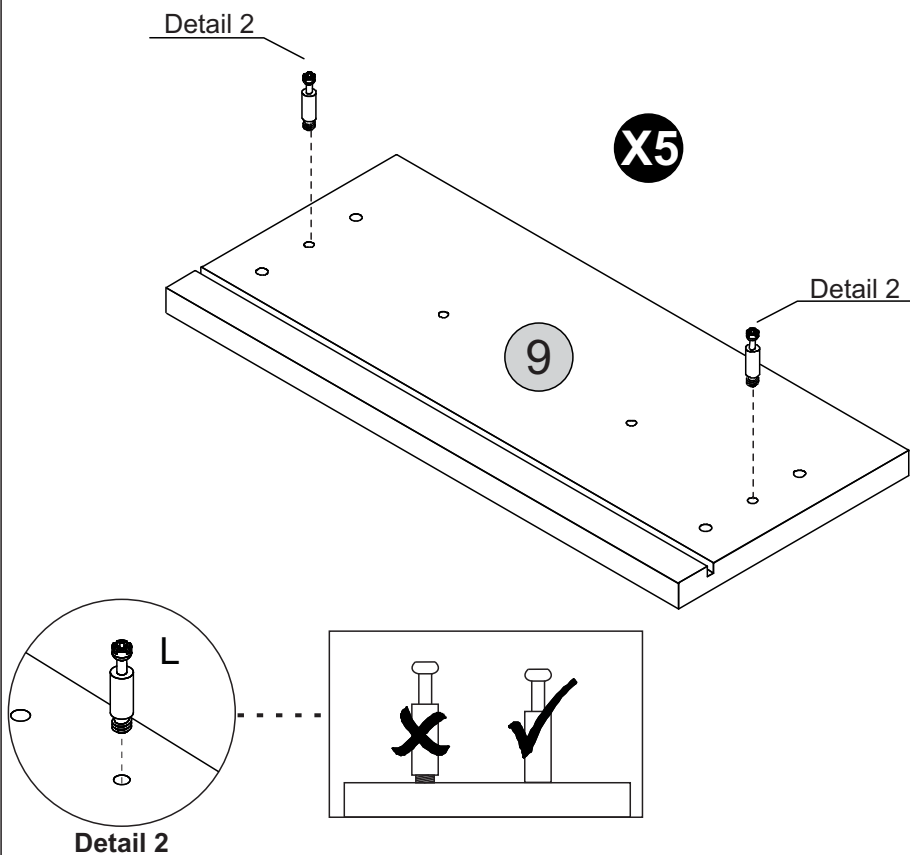
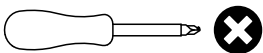

# STEP 13

## PARTS REQUIRED

7 - DRAWER SIDE (BLUE) x10

8 - DRAWER BACK PANEL (GREEN)x5

## HARDWARE REQUIRED

D  10  
Ø4,0 x 50mm

## TOOLS REQUIRED

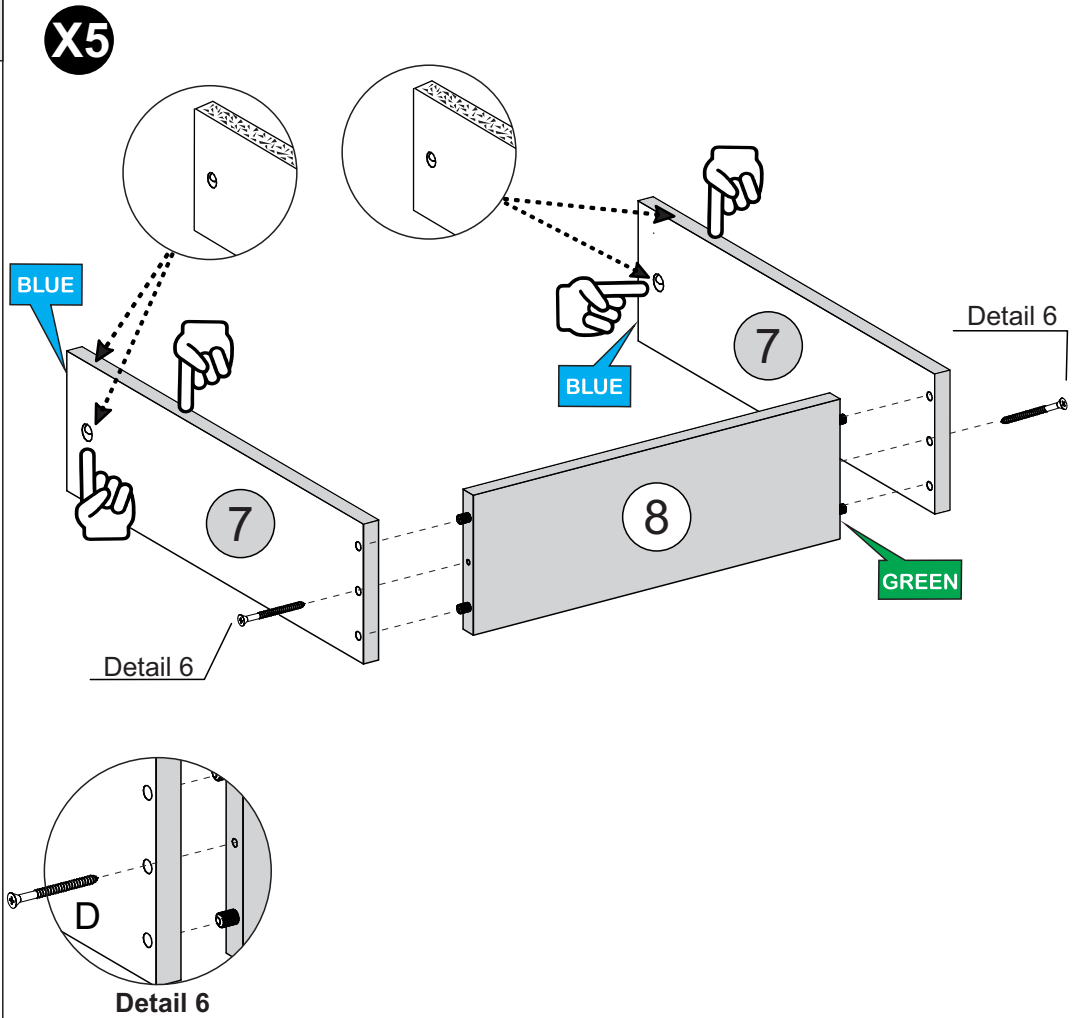
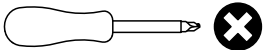

# STEP 14

## PARTS REQUIRED

9 - DRAWER FRONT x5

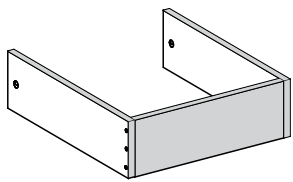

## HARDWARE REQUIRED

G  10

N  GLUE 01

## TOOLS REQUIRED

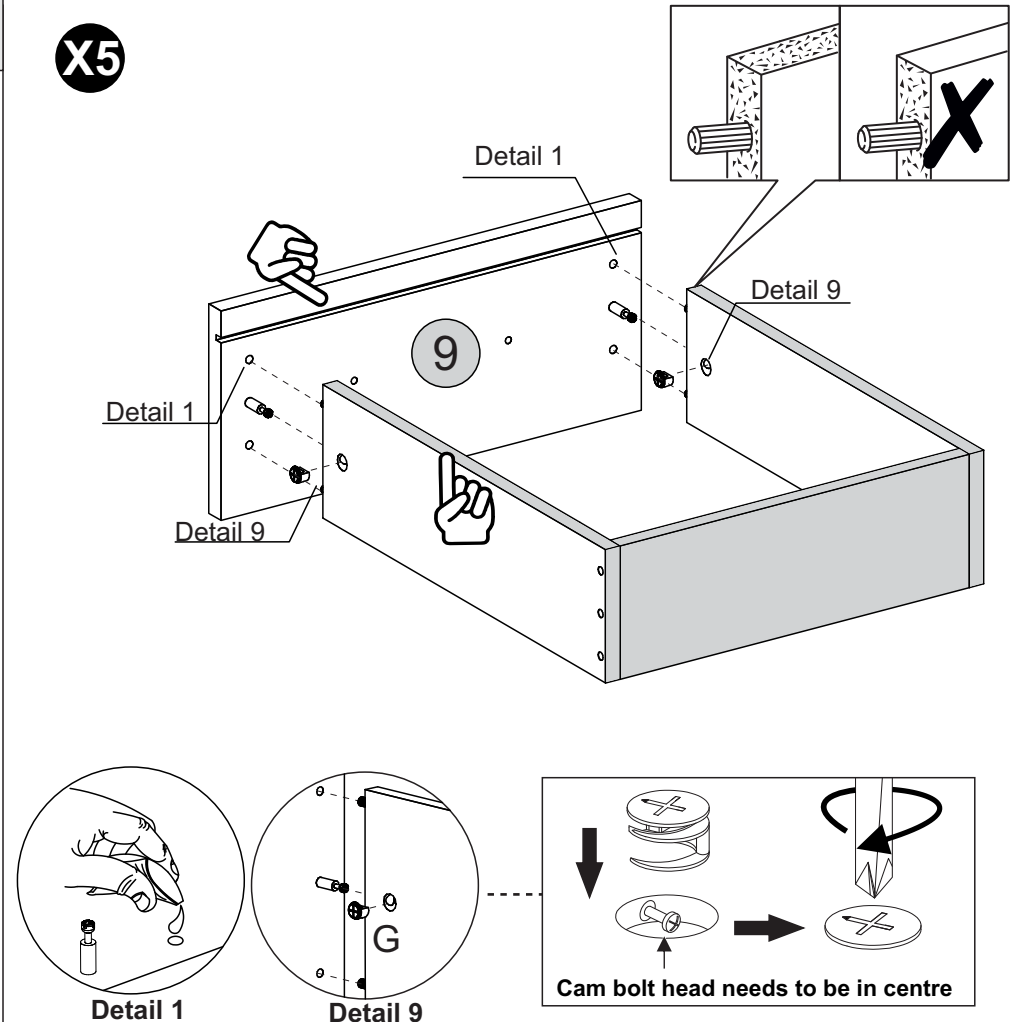
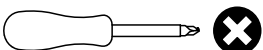

# STEP 15

## PARTS REQUIRED

10 - DRAWER BOTTOM x5

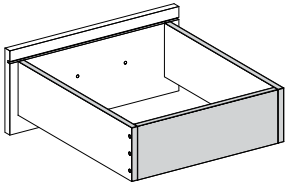

## HARDWARE REQUIRED

F  20  
10 x 10

## TOOLS REQUIRED

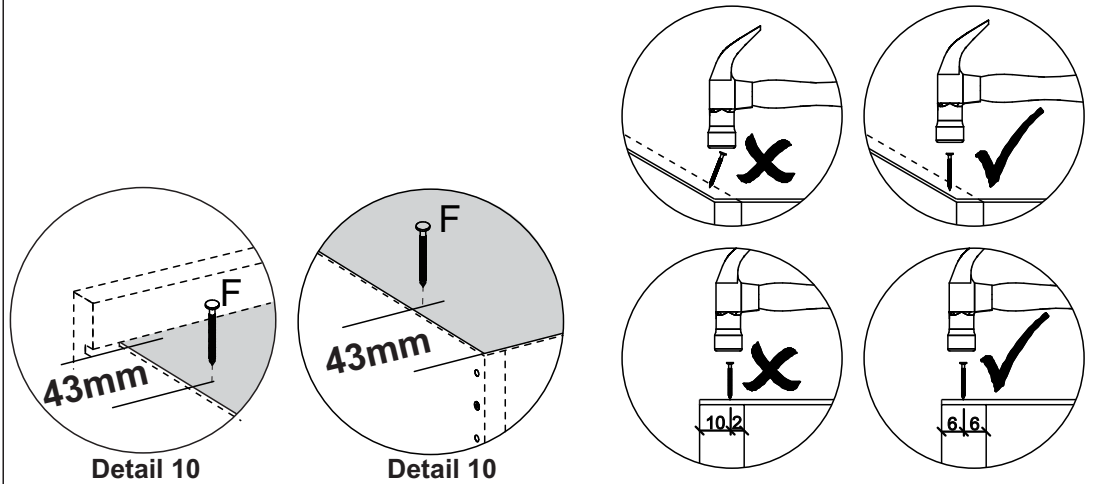
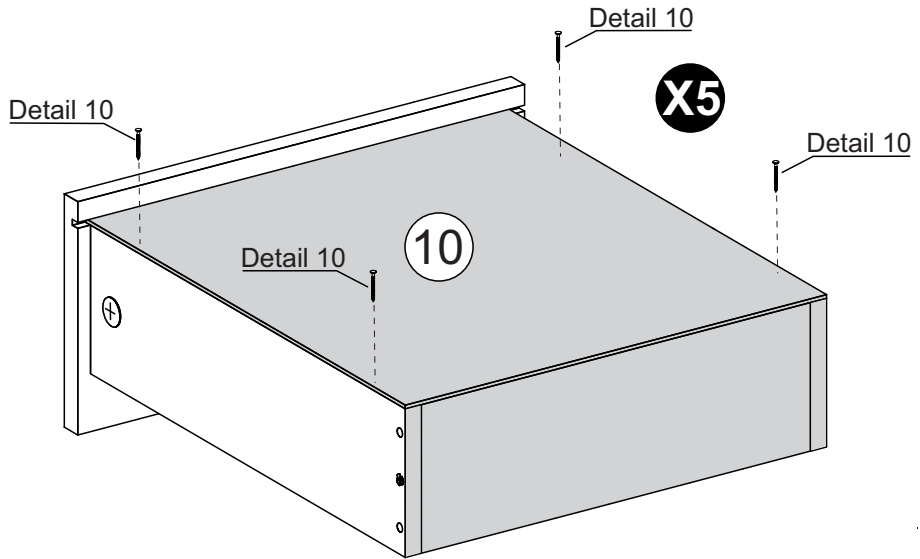
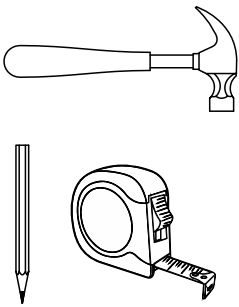

# STEP 16

## PARTS REQUIRED

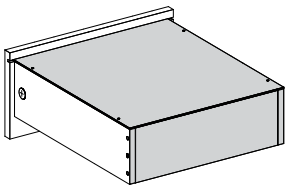

## HARDWARE REQUIRED

F  20  
10 x 10

## TOOLS REQUIRED

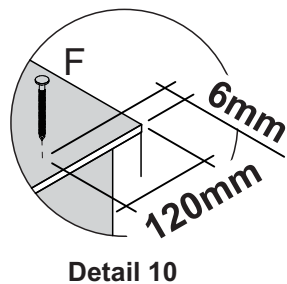
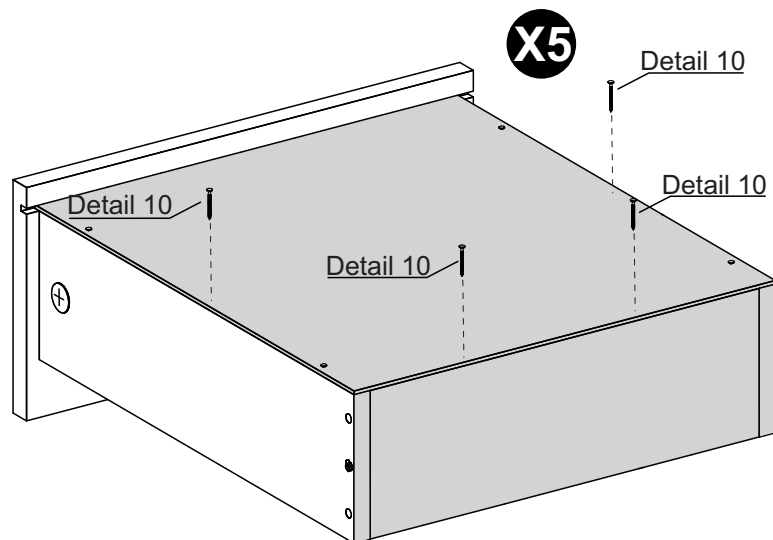
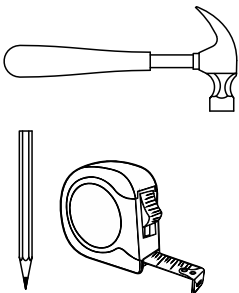

# STEP 17

**PARTS REQUIRED**

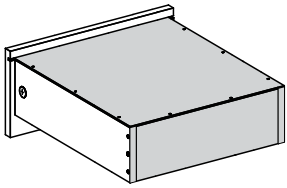

**HARDWARE REQUIRED**

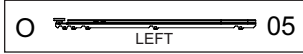
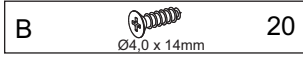

**TOOLS REQUIRED**

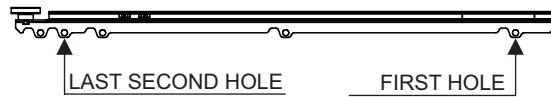
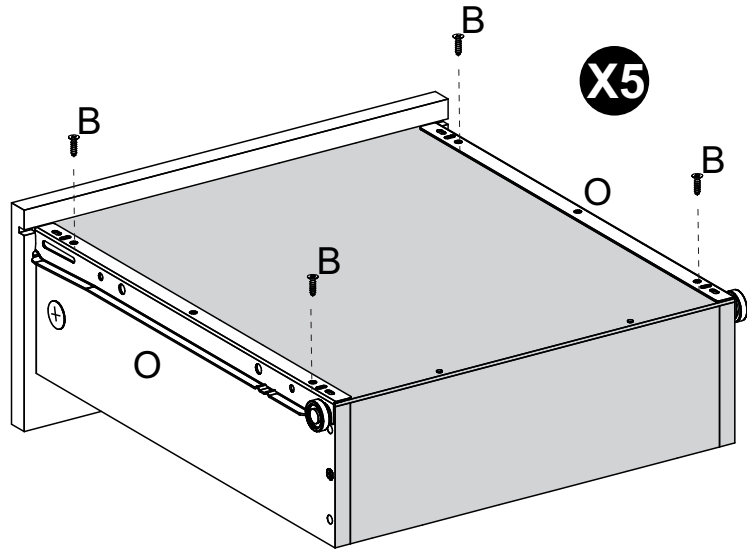
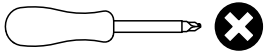

# STEP 18

**PARTS REQUIRED**

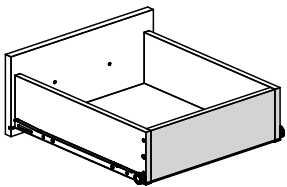

**HARDWARE REQUIRED**

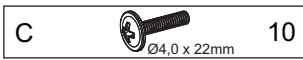

**TOOLS REQUIRED**

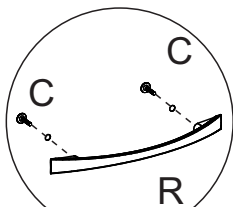
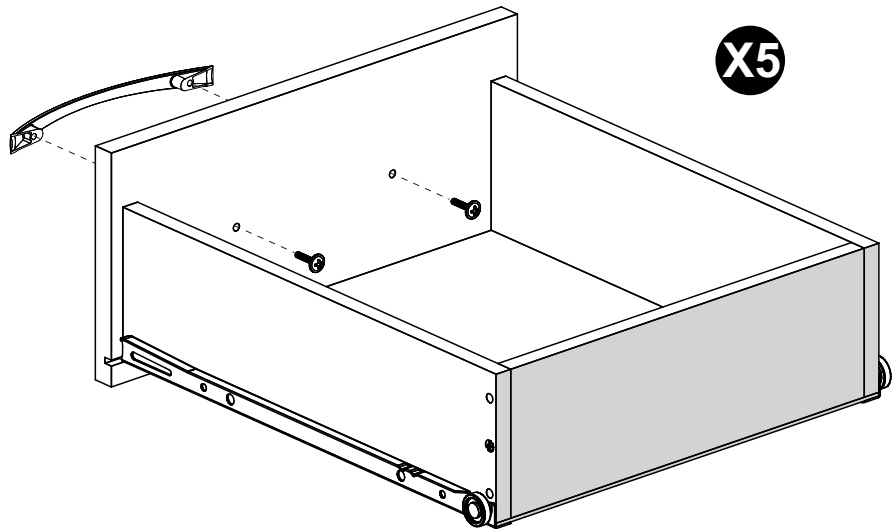
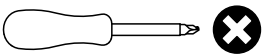

Detail 2

# STEP 19

**PARTS REQUIRED**

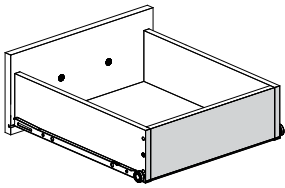

**HARDWARE REQUIRED**



**TOOLS REQUIRED**

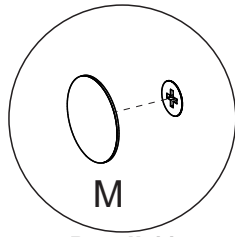
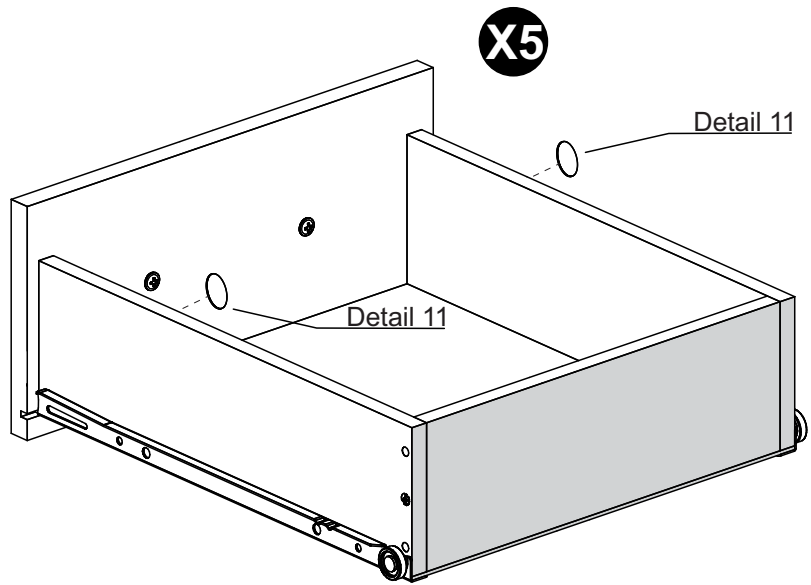

Detail 11

# STEP 20

**PARTS REQUIRED**

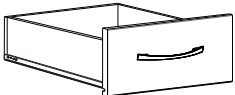
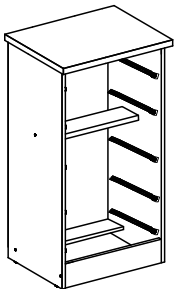

**HARDWARE REQUIRED**



**TOOLS REQUIRED**

 See the last page

**TIP**  
If desired, after assembly use an alcohol cleaner to erase the number printed on the parts.

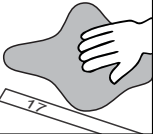

Detail 11

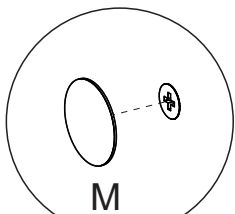
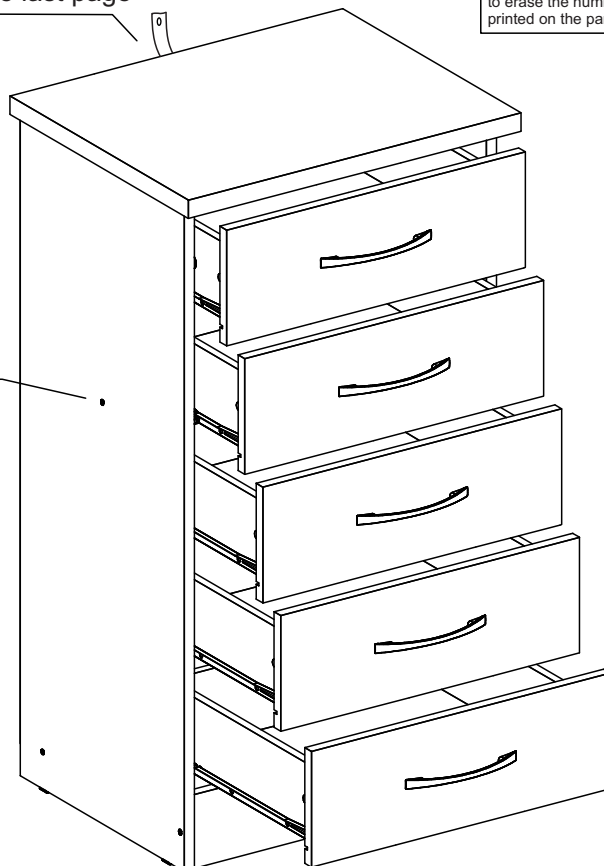

Detail 11

## WARNING

**Serious or fatal injuries can occur from furniture tipping over. To prevent the furniture from tipping over we recommend that it is permanently fixed to the wall.**

Wall fixings are not supplied with this product as different wall materials require different types of fixing devices.

Please make sure you use fixings suitable for the walls in your home.

