

MADRID 5 DRAWER NARROW CHEST ASSEMBLY INSTRUCTIONS

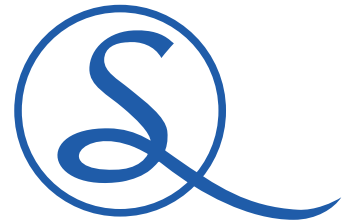
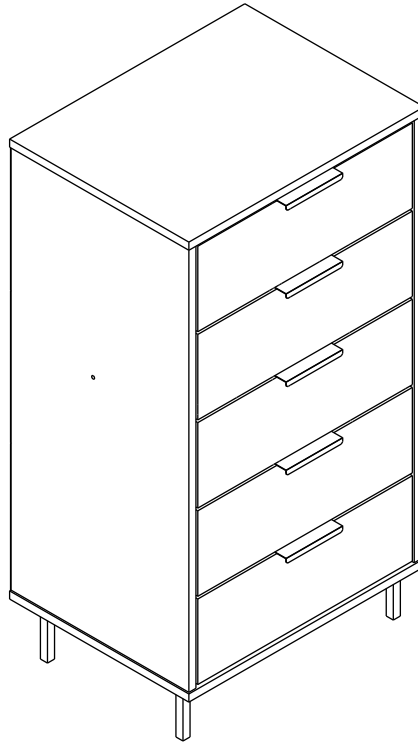

IMPORTANT FOR DOMESTIC USE ONLY

PLEASE READ BEFORE YOU CONTINUE FURTHER

CARE AND MAINTENANCE

After unpacking this product please keep the original packaging in case it needs to be returned for any reason.

- Please ensure all fittings and parts are present before commencing with assembly.
- Never drag or push products as this could cause damage to the joints making it inferior.
- We strongly recommend that you keep children away from your work area.
- We recommend that you lay a blanket or sheet on the floor to avoid damage to both your floor and the product.
- Assemble this product as close to its final position as possible.
- Do not place this product next to a radiator or in direct sunlight.
- Do not drag or push items across your high gloss furniture as this may cause the surface to scratch
- Wood is a natural product and may expand if subjected to damp and may shrink or crack if subjected to heat. Therefore it is recommended that room temperature is maintained, with no sudden temperature fluctuations.
- Make sure any spillage is wiped off immediately.
- Do not place hot or chilled items directly on to the surface, use a place mat or marking will occur.
- For general cleaning use a soft cotton or micro fibre cloth, and do not use detergents of any kind.
- From time to time it may be necessary to tighten fittings, regular inspections should be carried out.
- Do not place on a wet or damp floor as staining may occur to your floor.

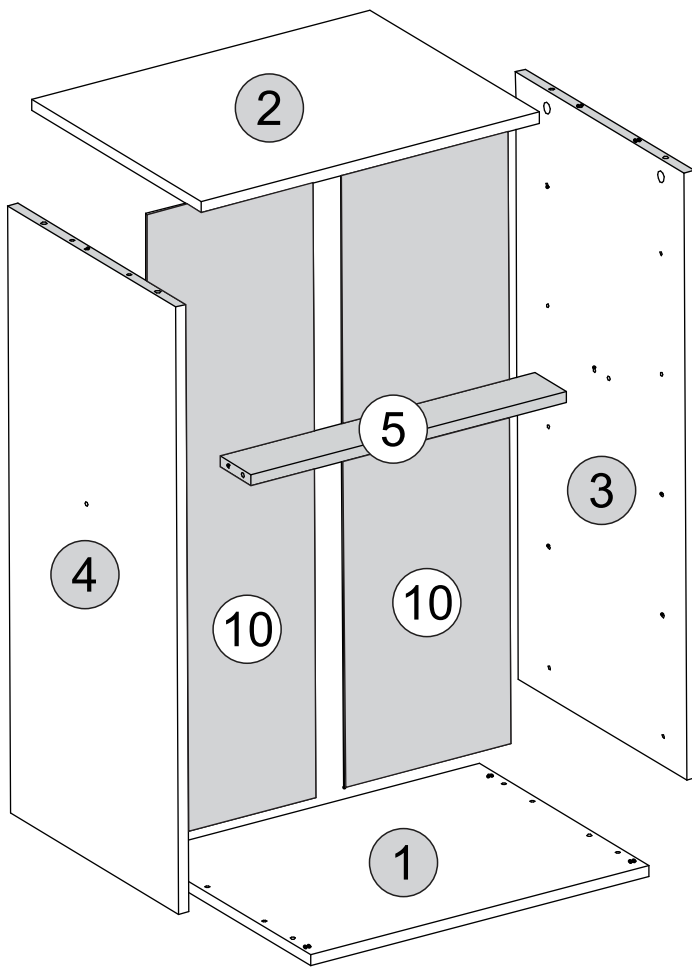

TOOLS REQUIRED

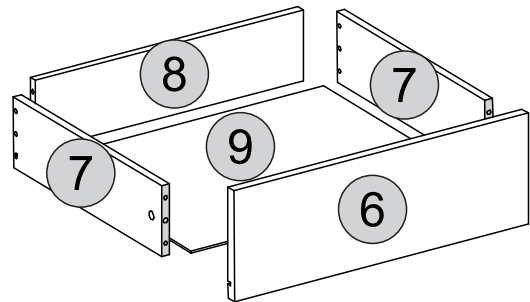
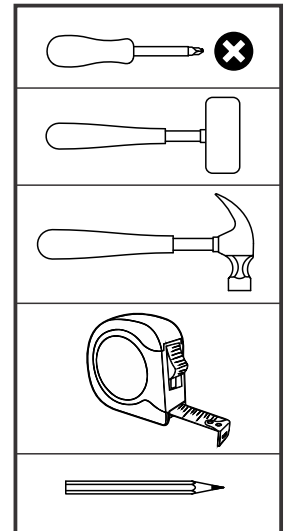







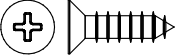
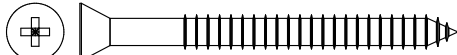

PARTS LIST

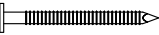
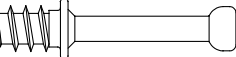
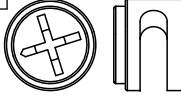
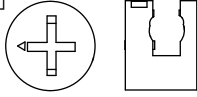
Please Note:
The below parts have all been stamped with the part number to help identify them during assembly.

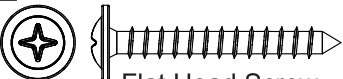
Part Number	Part Code	Part Description	Quantity	Carton
01	S100-102-164-CA1-01	Base Panel	1	1/1
02	S100-102-164-CA1-02	Top Panel	1	1/1
03	S100-102-164-CA1-03	Right Side Panel	1	1/1
04	S100-102-164-CA1-04	Left Side Panel	1	1/1
05	S100-102-164-CA1-05	Crossbar	1	1/1
06	S100-102-164-CA1-06	Drawer Front	5	1/1
07	S100-102-164-CA1-07	Drawer Side	10	1/1
08	S100-102-164-CA1-08	Drawer Back Panel	5	1/1
09	S100-102-164-CA1-09	Drawer Bottom	5	1/1
10	S100-102-164-CA1-10	Back Panel	2	1/1

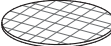
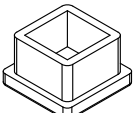
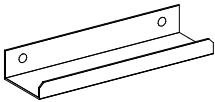
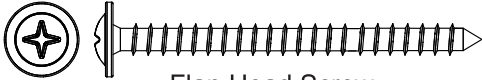
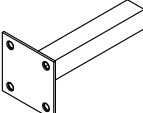
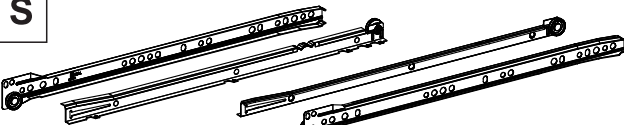
FITTINGS LIST

<p>A</p>  <p>Flat Head Screw Ø6,0 x 10mm (20x) +1/2</p>	<p>B</p>  <p>Flat Head Screw Ø4,0 x 14mm (48x) +1/2</p>	<p>C</p>  <p>Flat Head Screw Ø4,0 x 50mm (12x) +1/2</p>	<p>D</p>  <p>Dowel Ø6,0 x 30mm (50x) +1/2</p>	
<p>E</p>  <p>Nail 10 x 10 (62x) +1/2</p>	<p>F</p>  <p>Cam Bolt (14x) +1/2</p>	<p>G</p>  <p>Cam Nut (10x) +1/2</p>	<p>H</p>  <p>Cam Nut (4x) +1/1</p>	<p>I</p>  <p>Glue (1x)</p>
<p>J</p>  <p>Strap (1x)</p>	<p>K</p>  <p>Flat Head Screw Ø3,5 x 30mm (1x) +1/1</p>	<p>L</p>  <p>Washer (2x) +1/1</p>	<p>M</p>  <p>Hole Plugs (2x) +1/2</p>	<p>N</p>  <p>Hole Plugs (14x) +1/2</p>
<p>O</p>  <p>Internal Tip (4x) +1/1</p>	<p>P</p>  <p>Handle (5x)</p>	<p>Q</p>  <p>Flan Head Screw Ø4 x 50mm (8x) +1/1</p>	<p>R</p>  <p>Tubular Foot (4x)</p>	
<p>S</p>  <p>Drawer Runners (5x)</p>		<p>T</p>  <p>Back Panel Strip (1x)</p>		

TIPS FOR FITTINGS CAM-LOCKS

WHEN FITTING CAM NUT, ENSURE STARTING POSITION IS CORRECT BEFORE YOU INSERT CONNECTING CAM BOLT TURN CLOCKWISE UNTIL SECURE

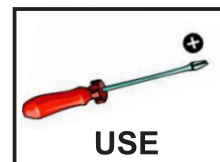
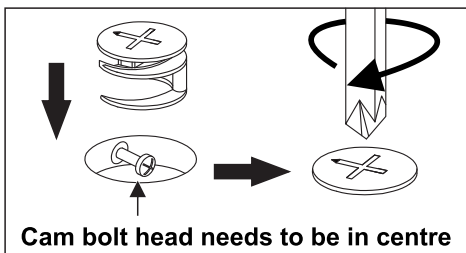
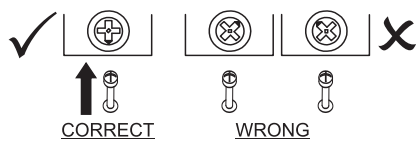

CAMBOLT
Tighten until shoulder in flush with panel. Do not overtighten or undertighten (see example beside)

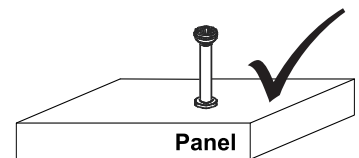
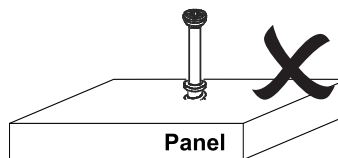
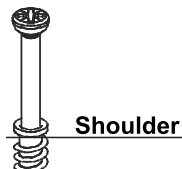

STEP 1

PARTS REQUIRED

3 - RIGHT SIDE PANEL x1

4 - LEFT SIDE PANEL x1

HARDWARE REQUIRED

D  08

I  01

TOOLS REQUIRED

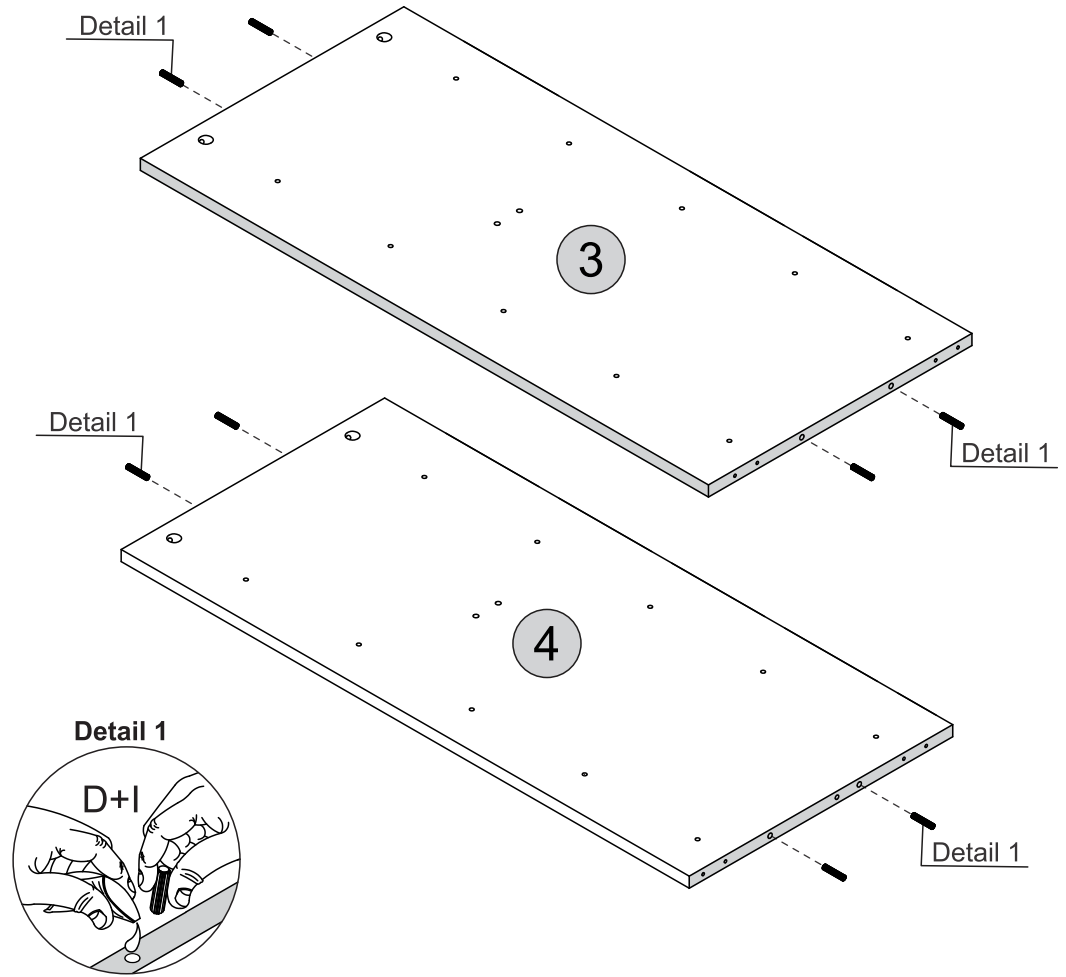
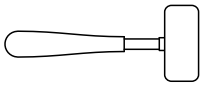

STEP 2

PARTS REQUIRED

3 - RIGHT SIDE PANEL x1

4 - LEFT SIDE PANEL x1

HARDWARE REQUIRED

A  20
Ø6,0 x 10mm

S  05

TOOLS REQUIRED

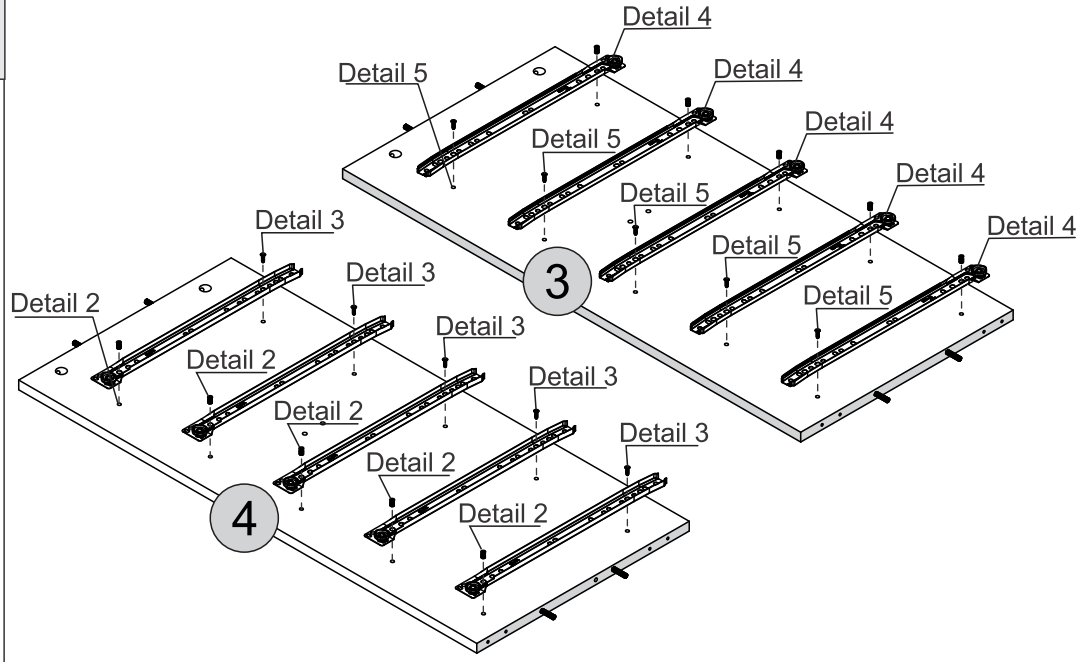
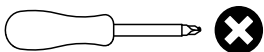

Please note pre-drilled holes

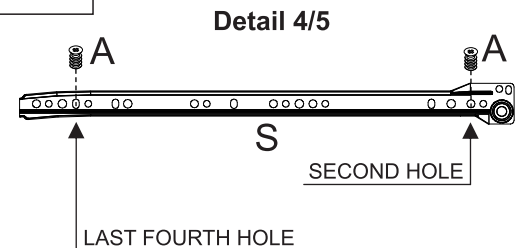
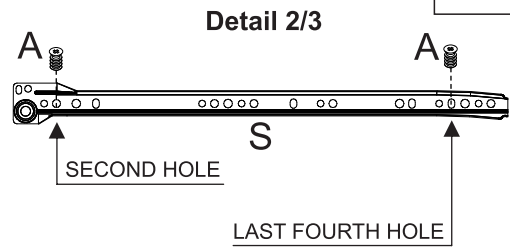

STEP 3

PARTS REQUIRED

2 - TOP PANEL x1

5 - CROSSBAR x1

HARDWARE REQUIRED

D  02

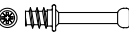
F  04

I  01

O  04

R  04

TOOLS REQUIRED

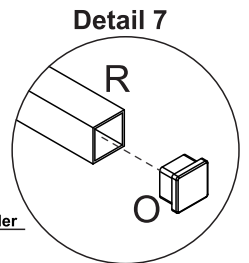
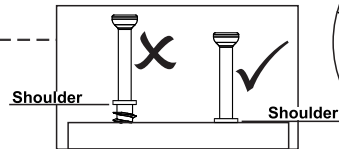
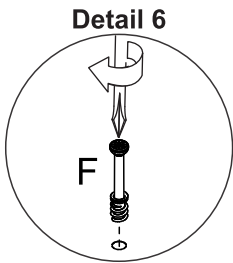
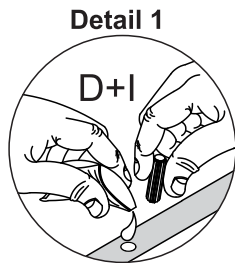
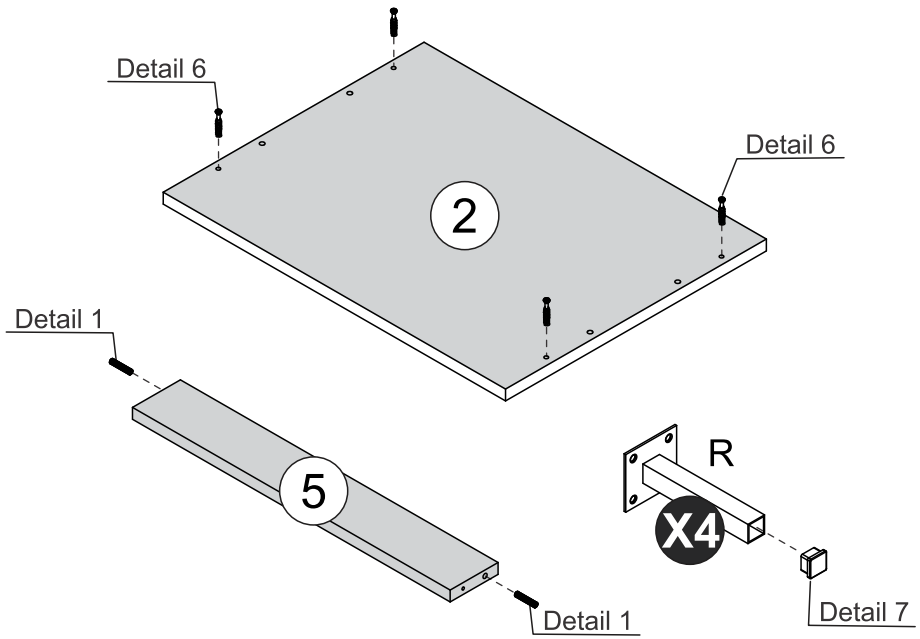
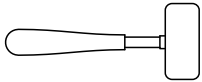
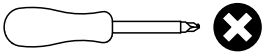

STEP 4

PARTS REQUIRED

3 - RIGHT SIDE PANEL x1

4 - LEFT SIDE PANEL x1

5 - CROSSBAR x1

HARDWARE REQUIRED

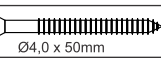
C  02
Ø4,0 x 50mm

TOOLS REQUIRED

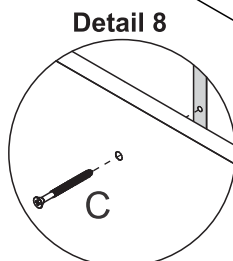
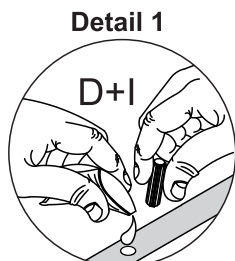
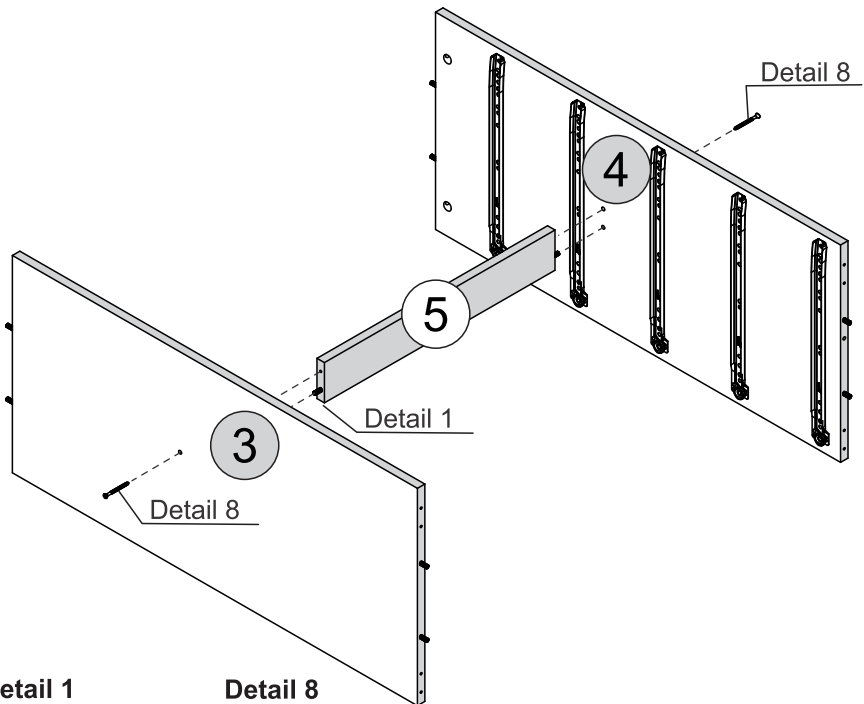
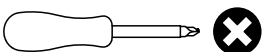

STEP 5

PARTS REQUIRED

2 - TOP PANEL x1

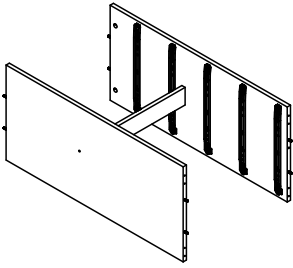

HARDWARE REQUIRED

H  04

N  04

TOOLS REQUIRED

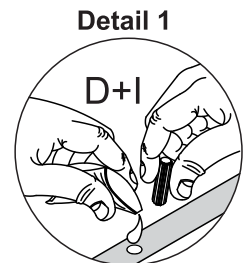
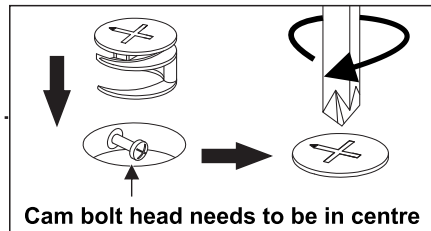
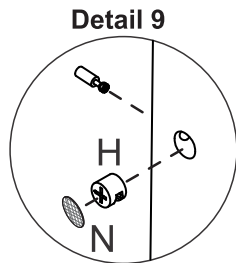
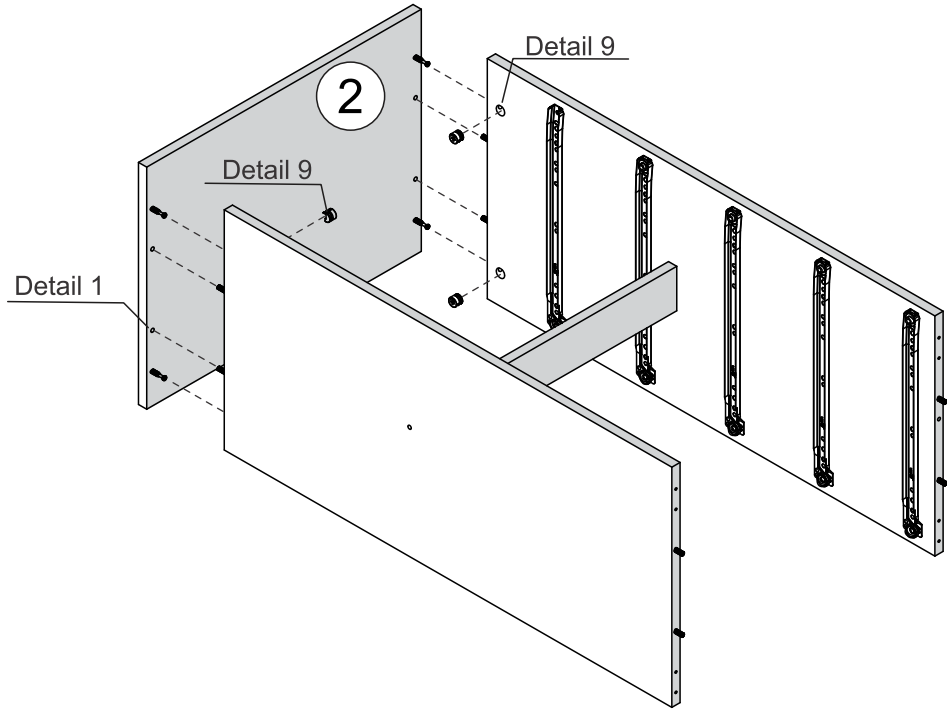
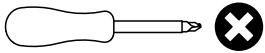

STEP 6

PARTS REQUIRED

1 - BASE PANEL x1

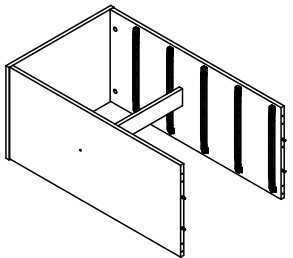

HARDWARE REQUIRED

Q  08
Ø4,0 x 50mm

R  04

TOOLS REQUIRED

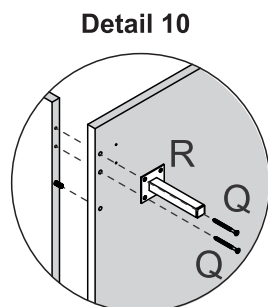
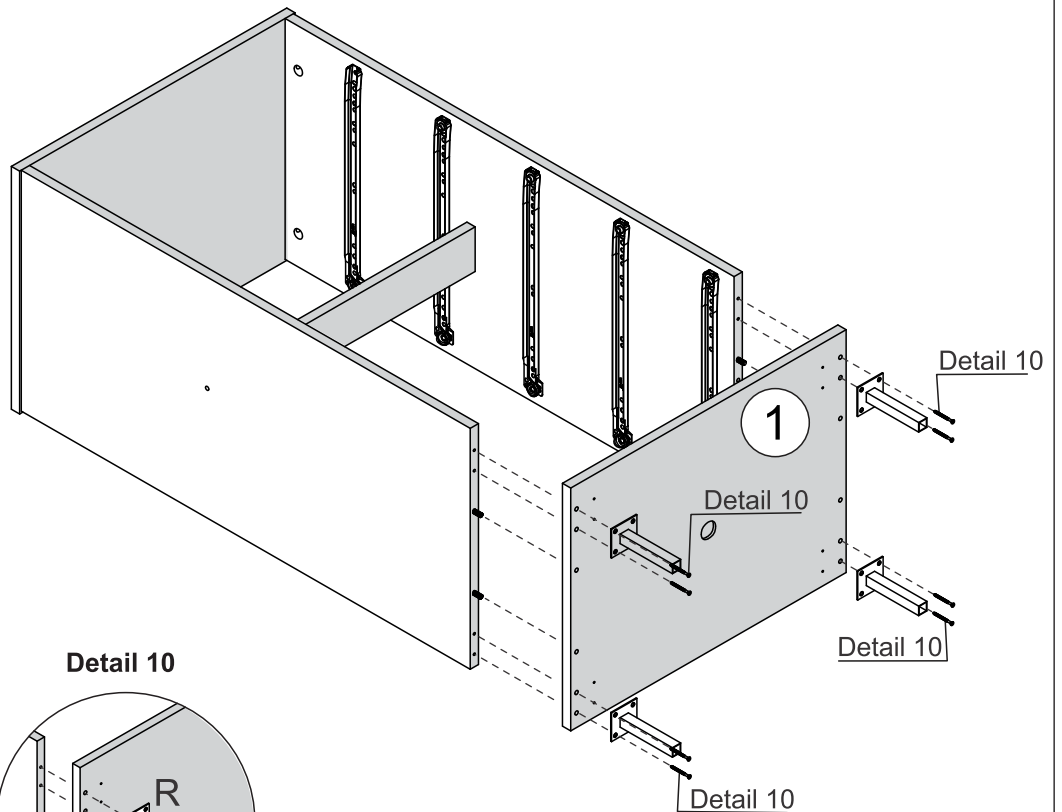
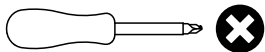

STEP 7

PARTS REQUIRED

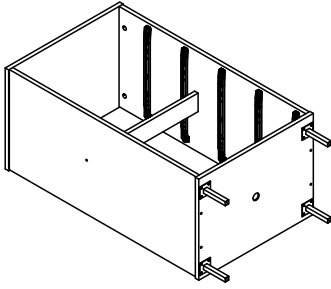

HARDWARE REQUIRED

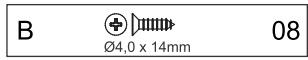

TOOLS REQUIRED

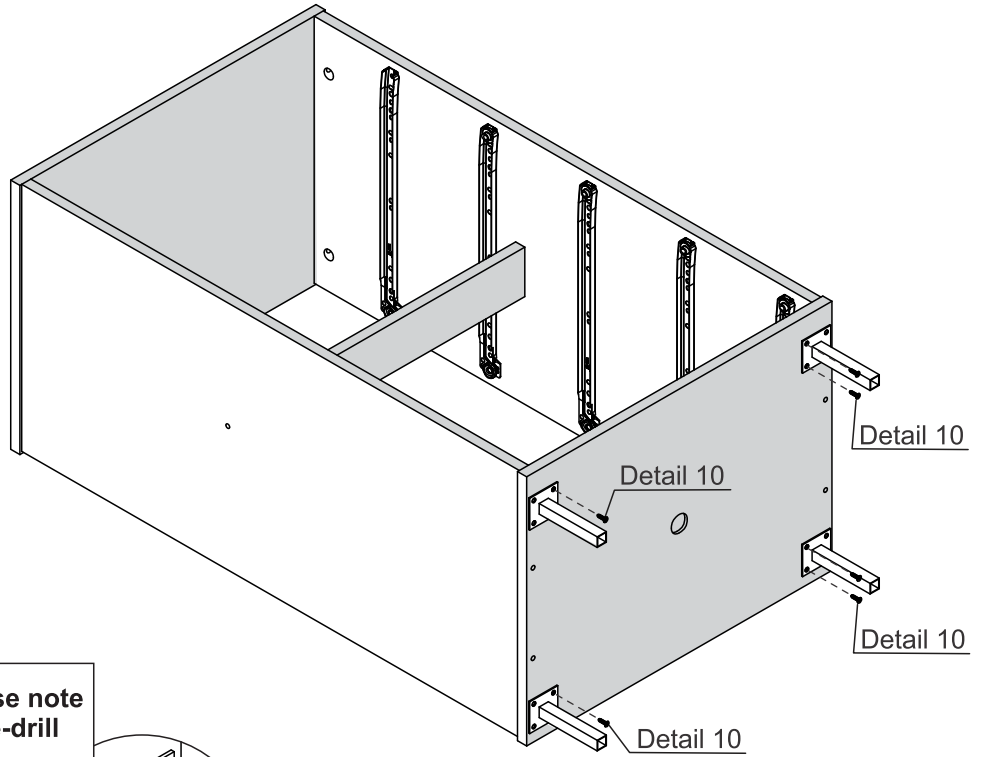
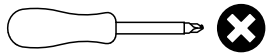

Please note pre-drill

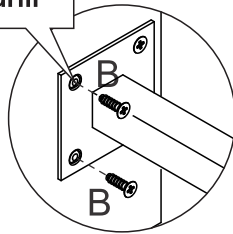

Detail 10

STEP 8

PARTS REQUIRED

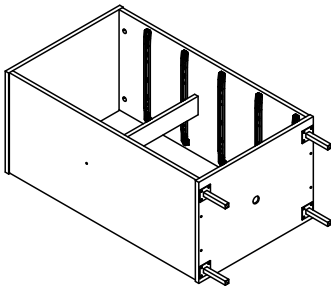

HARDWARE REQUIRED

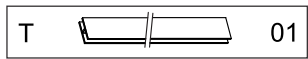

TOOLS REQUIRED

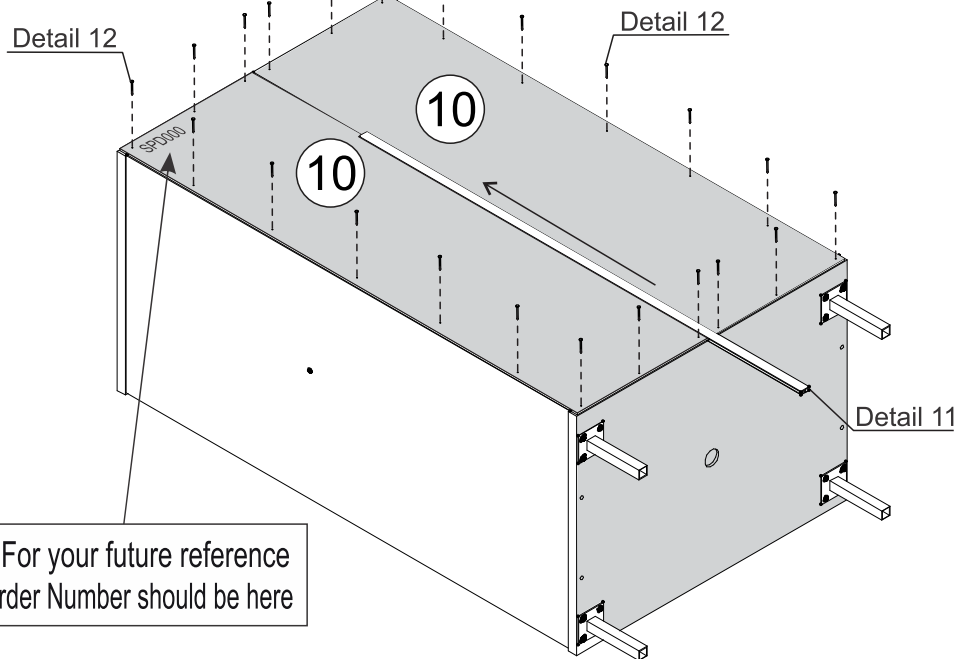
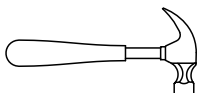

* For your future reference Order Number should be here

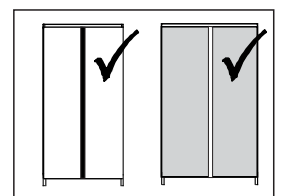
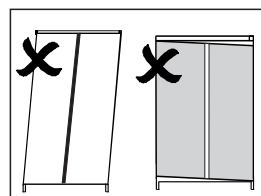
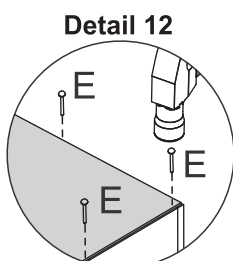
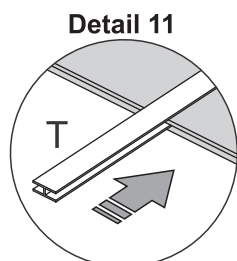



STEP 9

PARTS REQUIRED

6 - DRAWER FRONT	x5
7 - DRAWER SIDE	x10
8 - DRAWER BACK PANEL	x5

HARDWARE REQUIRED

D		40
F		10
I		01

TOOLS REQUIRED

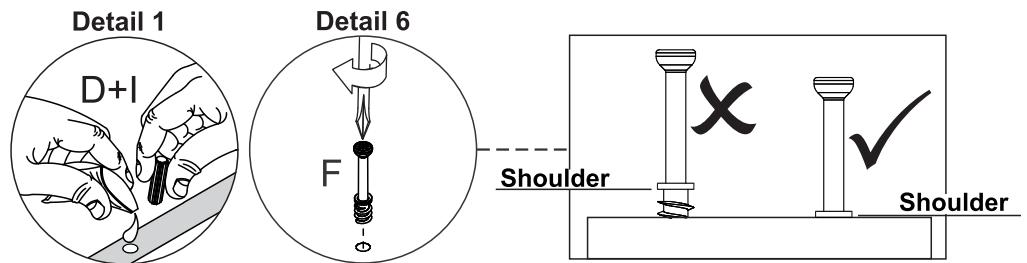
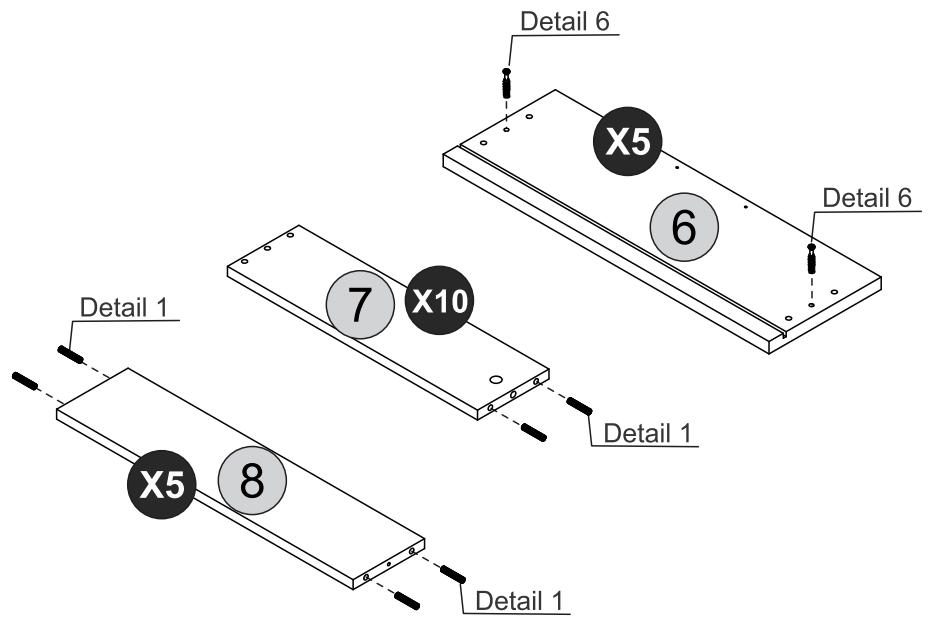
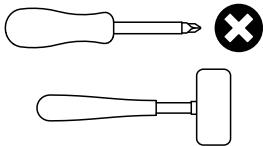

STEP 10

PARTS REQUIRED

7 - DRAWER SIDE	x10
8 - DRAWER BACK	x5

HARDWARE REQUIRED

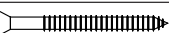
C		10
<small>Ø4,0 x 50mm</small>		

TOOLS REQUIRED

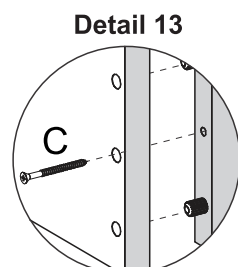
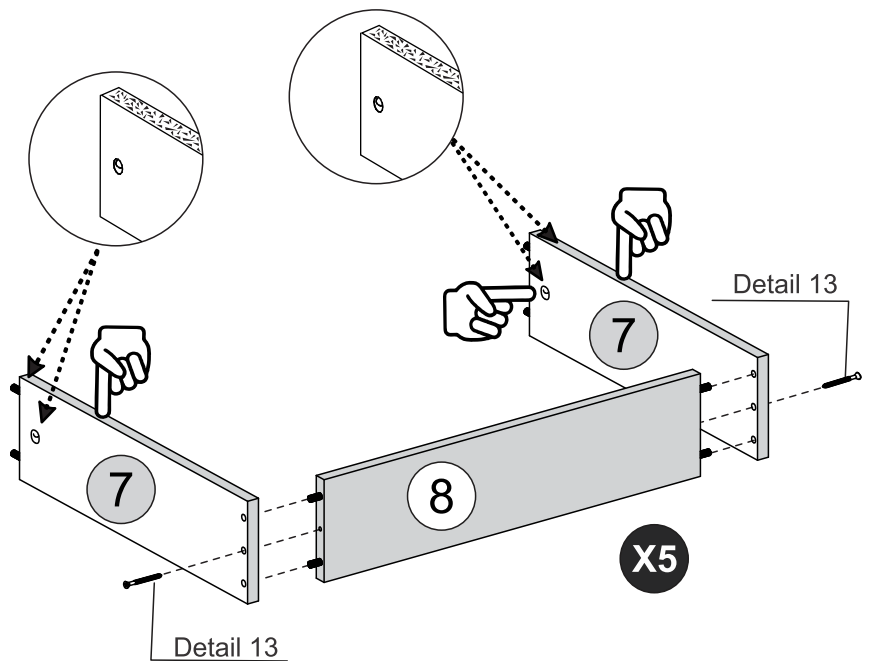
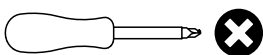

STEP 11

PARTS REQUIRED

6 - DRAWER FRONT x5

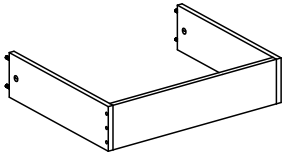

HARDWARE REQUIRED

G  10

I  01

N  10

TOOLS REQUIRED

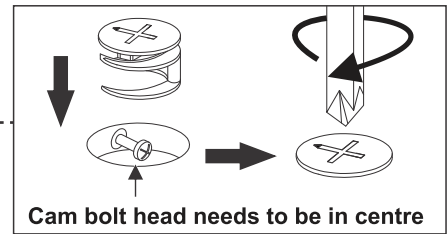
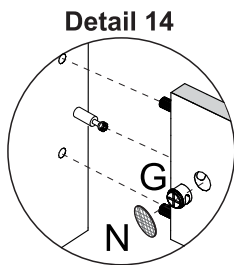
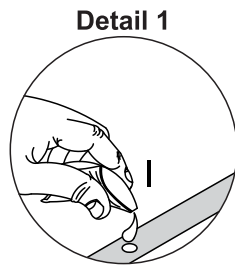
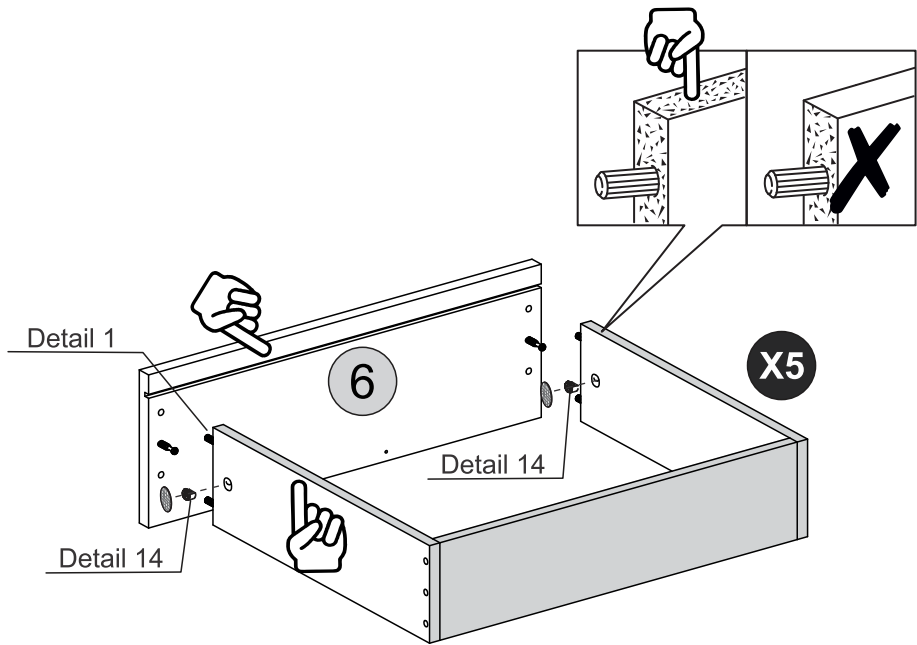
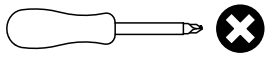

STEP 12

PARTS REQUIRED

9 - DRAWER BOTTOM x5

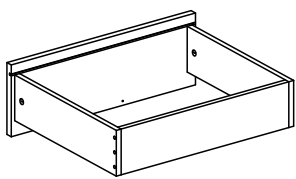

HARDWARE REQUIRED

E  40

TOOLS REQUIRED

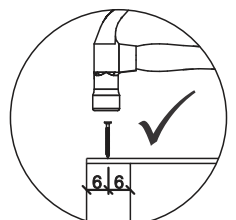
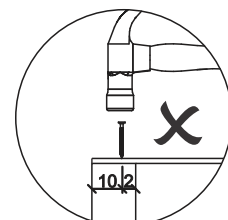
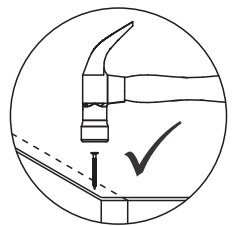
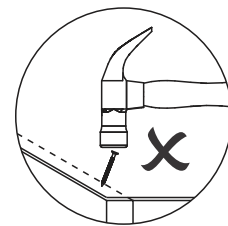
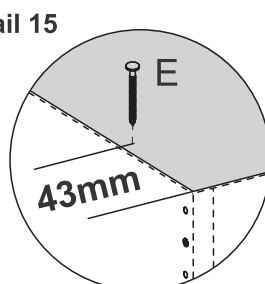
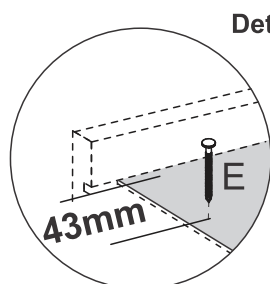
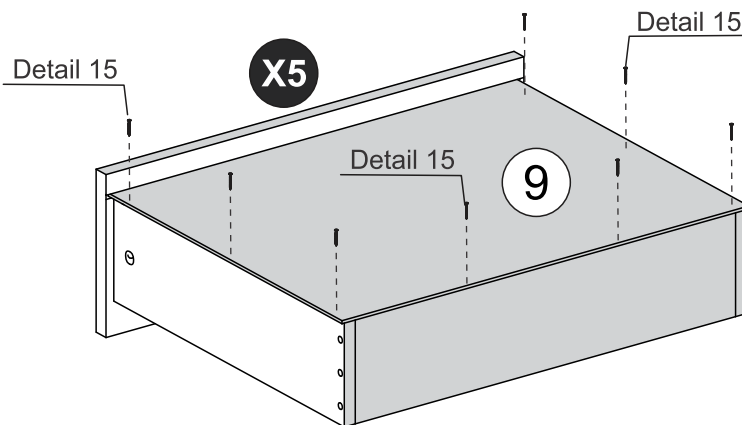
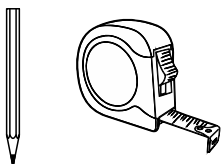
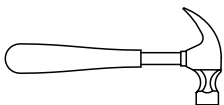

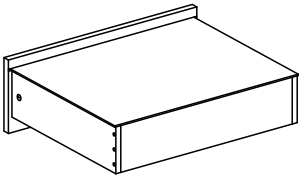

STEP 13

PARTS REQUIRED

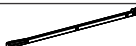

HARDWARE REQUIRED

B		20
Ø4,0 x 14mm		
S		05
LEFT		
S		05
RIGHT		

TOOLS REQUIRED

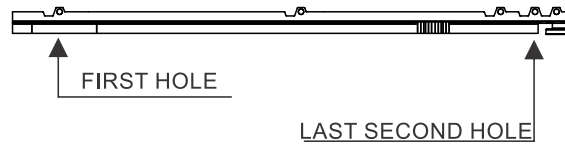
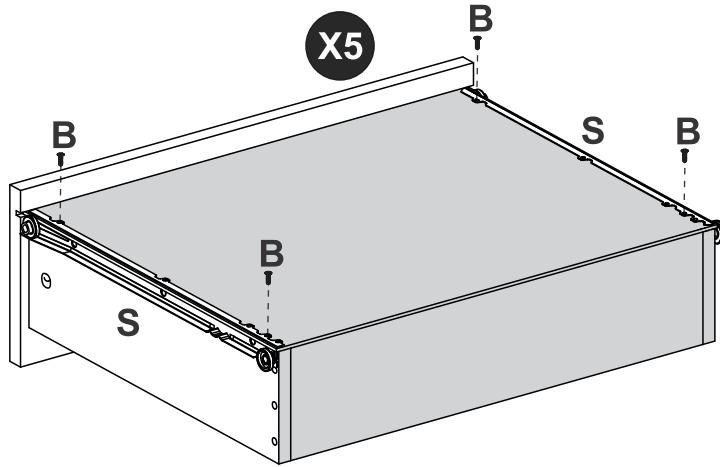
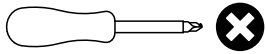

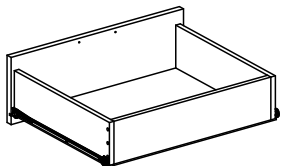

STEP 14

PARTS REQUIRED



HARDWARE REQUIRED

B		10
Ø4,0 x 14mm		
P		05

TOOLS REQUIRED

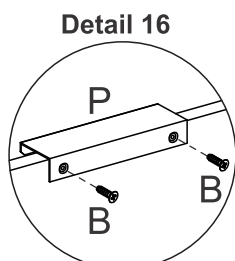
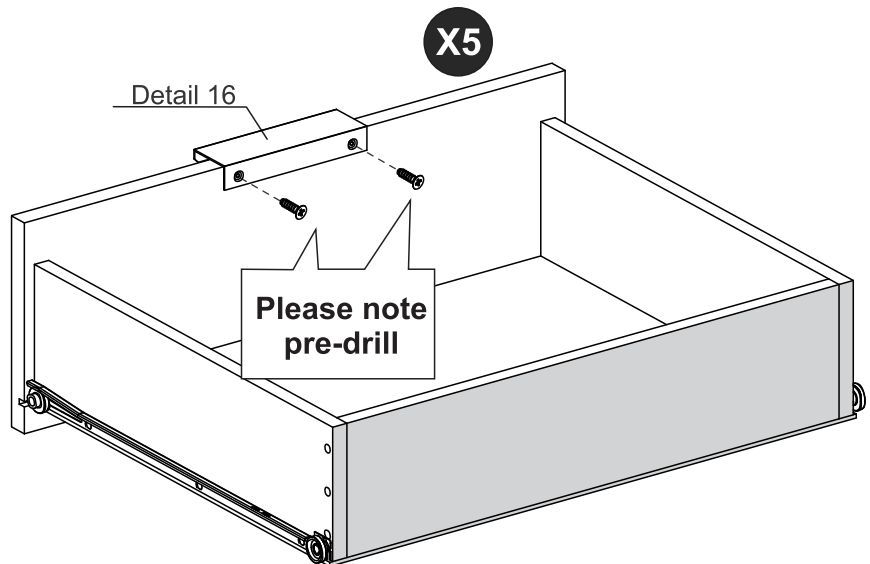
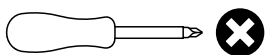

STEP 15

PARTS REQUIRED

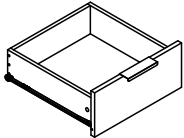
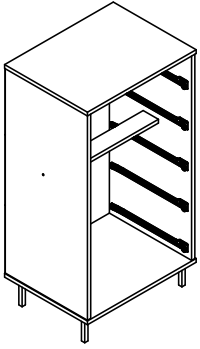

X5

HARDWARE REQUIRED



02

TOOLS REQUIRED

 See the last page 

Detail 17

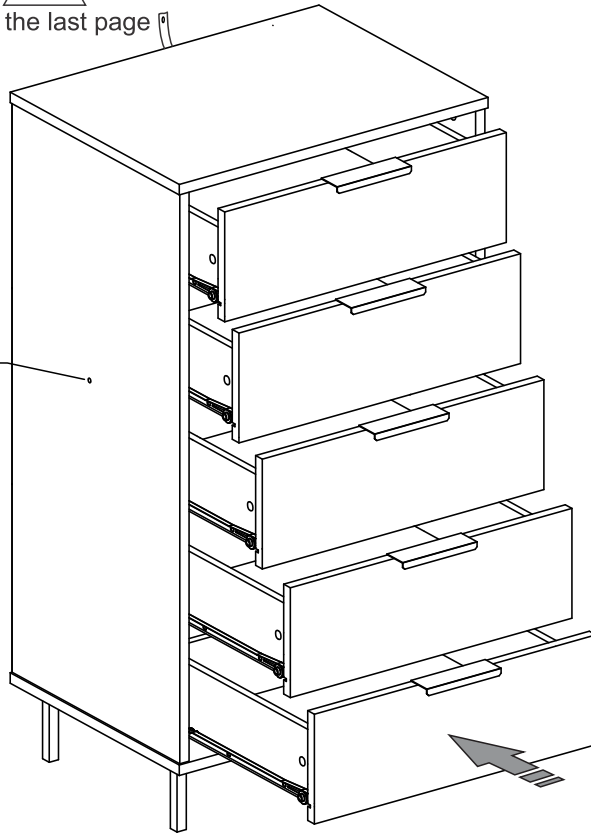

Detail 17

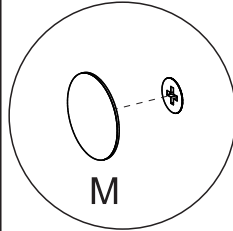

STEP 16

PARTS REQUIRED

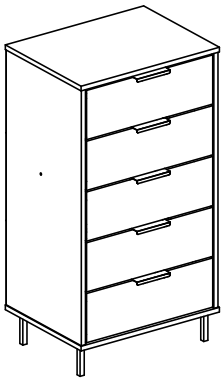

HARDWARE REQUIRED

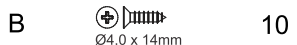

Ø4,0 x 14mm

10

TOOLS REQUIRED

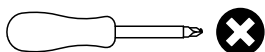

TIP
If desired, after assembly use an alcohol cleaner to erase the number printed on the parts.

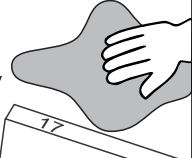

Detail 18

Detail 18

Detail 18

Detail 18

Detail 18

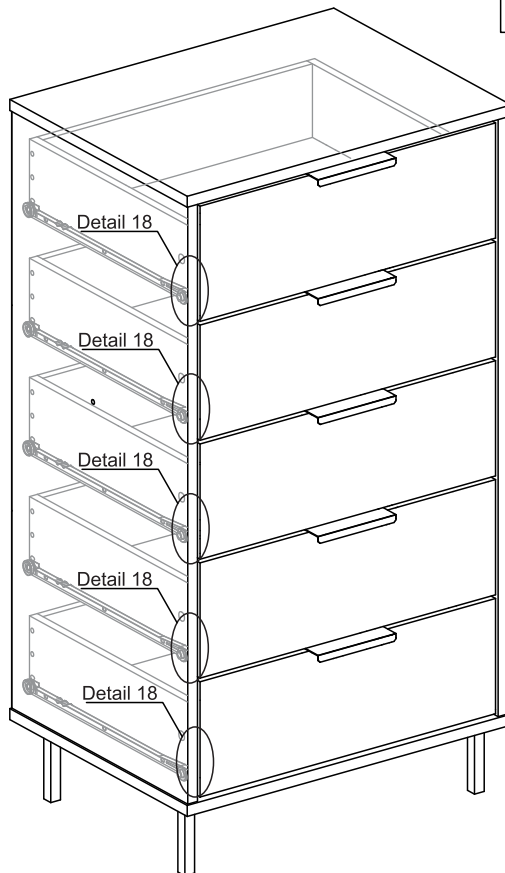

Detail 18
Drawer Lock

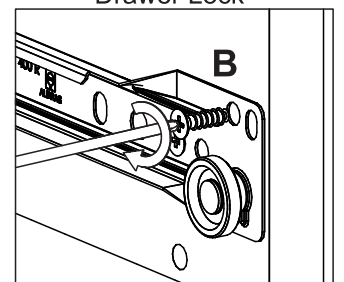

WARNING

Serious or fatal injuries can occur from furniture tipping over. To prevent the furniture from tipping over we recommend that it is permanently fixed to the wall.

Wall fixings are not supplied with this product as different wall materials require different types of fixing devices.

Please make sure you use fixings suitable for the walls in your home.

