

LIGHT GREY DAKOTA 6 DRAWER CHEST ASSEMBLY INSTRUCTIONS

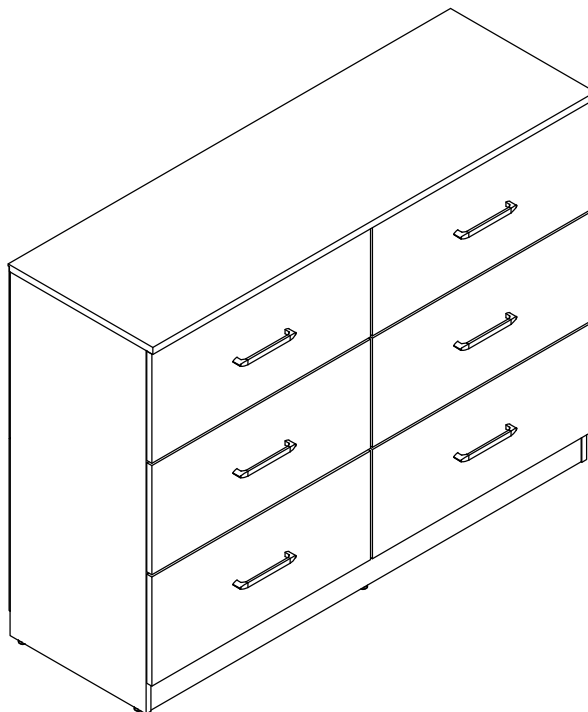
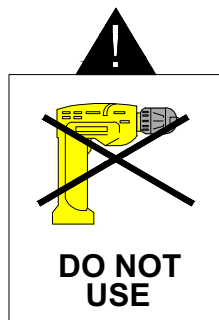

IMPORTANT FOR DOMESTIC USE ONLY PLEASE READ BEFORE YOU CONTINUE FURTHER

THE PRODUCT YOU HAVE PURCHASED WILL GIVE YOU MANY YEARS OF SERVICE IF YOU FOLLOW THE GUIDELINES FOR ITS SAFE ASSEMBLY AND PERIODIC MAINTENANCE AND CLEANING.

ASSEMBLE ON A SOFT CLEAN SURFACE.

DO NOT USE ANY TOOLS OTHER THAN THOSE SHOWN.

ANY SPANNERS OR ALLEN KEYS REQUIRED ARE INCLUDED WITH THE FITTINGS KIT.

DO NOT FOR ANY REASON USE A POWER TOOL TO ASSEMBLE THIS PRODUCT. ITS USE WILL INVALIDATE ANY CLAIM YOU MAY HAVE AND COULD MAKE THIS PRODUCT UNSAFE.

DEPENDING ON THE AMOUNT OF USE THIS PRODUCT RECEIVES IT MAY BE NECESSARY TO TIGHTEN UP THE FIXINGS FROM TIME TO TIME. THIS IS COMPLETELY NORMAL FOR ANY FLAT PACK FURNITURE. DO NOT OVERTIGHTEN FIXING.

FOR CLEANING, YOU MAY USE A DAMP CLOTH (NOT WET) DO NOT USE POLISH, DETERGENT OR CHEMICAL CLEANERS.



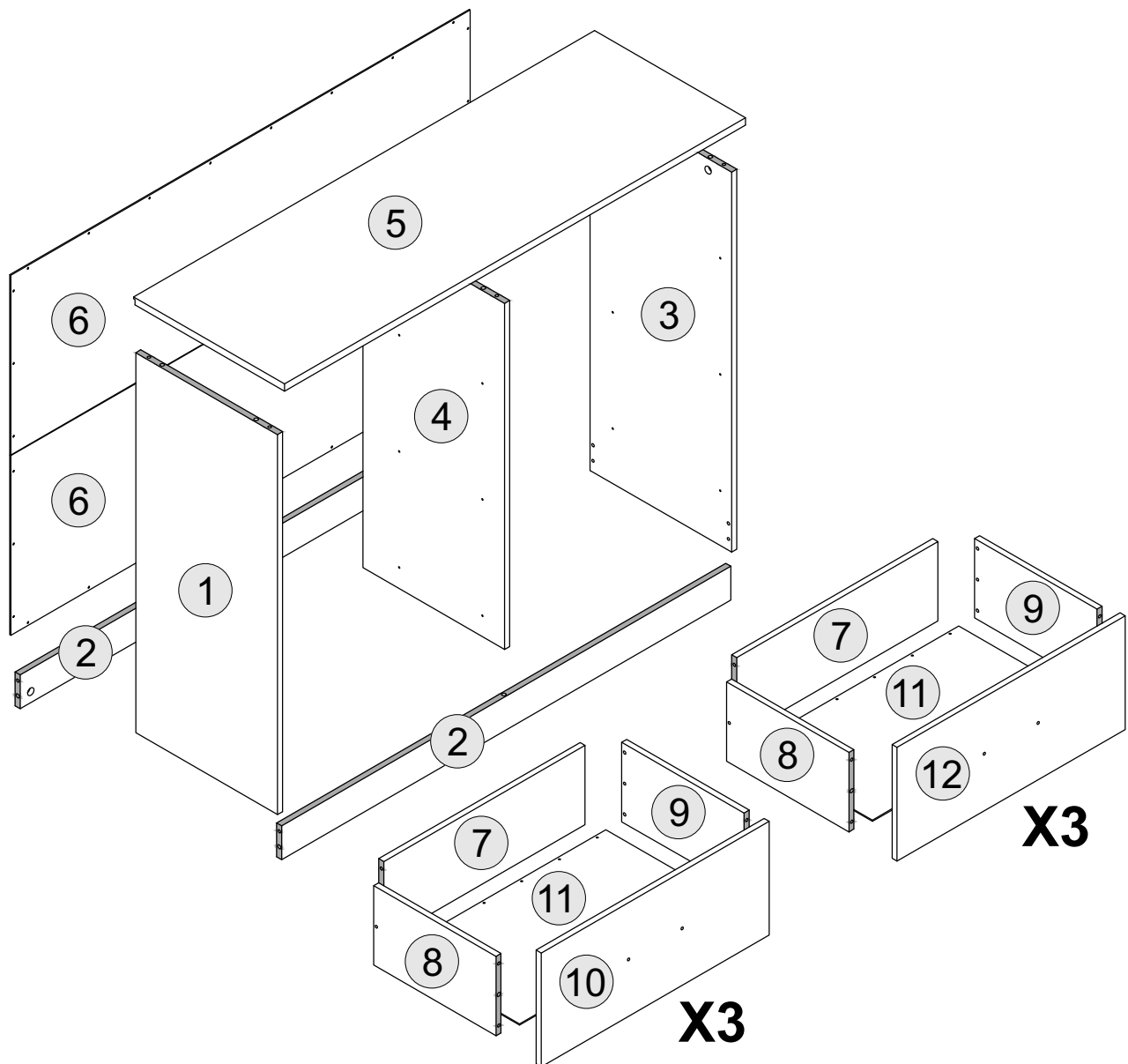











THE SURFACE OF THIS ITEM IS NOT HEAT RESISTANT. ALWAYS USE A PLACE MAT UNDER HOT OR COLD ITEMS TO PREVENT MARKING.

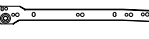
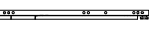

PART LIST

Part Number	Part Code	Part Description	Quantity	Carton
1	S100-102-213-EU1-01	Side Panel - Left	1	1/1
2	S100-102-213-EU1-02	Base Apron	2	1/1
3	S100-102-213-EU1-03	Side Panel - Right	1	1/1
4	S100-102-213-EU1-04	Centre Panel	1	1/1
5	S100-102-213-EU1-05	Top Panel	1	1/1
6	S100-102-213-EU1-06	Back Panel	2	1/1
7	S100-102-213-EU1-07	Drawer Back	6	1/1
8	S100-102-213-EU1-08	Drawer Side - Left	6	1/1
9	S100-102-213-EU1-09	Drawer Side Right	6	1/1
10	S100-102-213-EU1-10	Drawer Front - Left	3	1/1
11	S100-102-213-EU1-11	Drawer Base	6	1/1
12	S100-102-213-EU1-12	Drawer Front - Right	3	1/1

HARDWARE LIST

A		DOWEL 6 X 30MM	58 PCS
B		SCREW M4 X 38MM	12 PCS
C		SCREW M3.5 X 16MM	36 PCS
D		CAM BOLT + CAM NUT	24 SETS
E		HANDLE	6 PCS
F		HANDLE SCREW 18MM	12 PCS
G		TACK	56 PCS
H		SCREW M3.5 X 12MM	56 PCS
I		PLASTIC CORNER BLOCK	12 PCS
J		PLASTIC H STRIP	1 PC
K		PLASTIC FOOT	6 PCS
L		DRAWER RUNNER A - L/R	12 PCS
M		DRAWER RUNNER B - L/R	12 PCS
N		ANTI - TIP STRAP	2 PCS
O		SCREW M4 X 16MM	2 PCS
P		WASHER	24 PCS

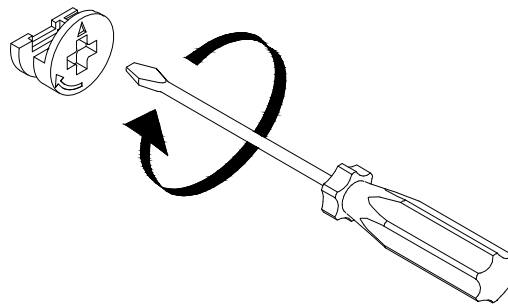

(SCREWDRIVER NOT PROVIDED)

USE A FLAT HEAD SCREWDRIVER TO TIGHTEN THE CAM NUTS. A QUARTER TURN CLOCKWISE IS ALL THAT IS NEEDED.

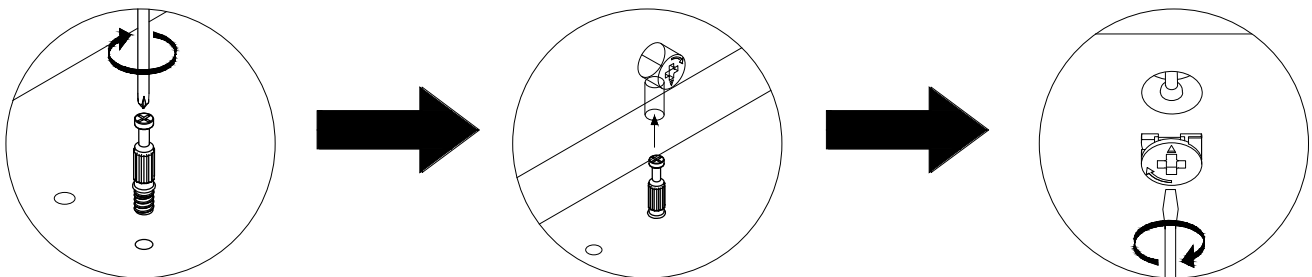

STEP 1 - USE A CROSS SLOT SCREWDRIVER TO TIGHTEN THE CAM BOLT INTO THE HOLE.

STEP 2 - ALIGN THE CAM BOLT WITH THE HOLE AND PUSH TOGETHER UNTIL FLUSH. (MAKE SURE THE ARROW OF THE CAM LOCK IS POINTING TOWARD ON THE EDGE OF THE PANEL.)

STEP 3 - THE HEAD OF THE BOLT GOES INTO THE WIDE MOUTH OF THE CAM LOCK. YOU THEN TURN THE LOCK SO THE NARROW PART CLOSES OVER THE BOLT.

STEP 1

PARTS REQUIRED

3 - SIDE PANEL - RIGHT x1

HARDWARE REQUIRED

A  02

D  02

H  12

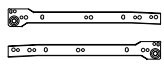
L  03

TOOLS REQUIRED

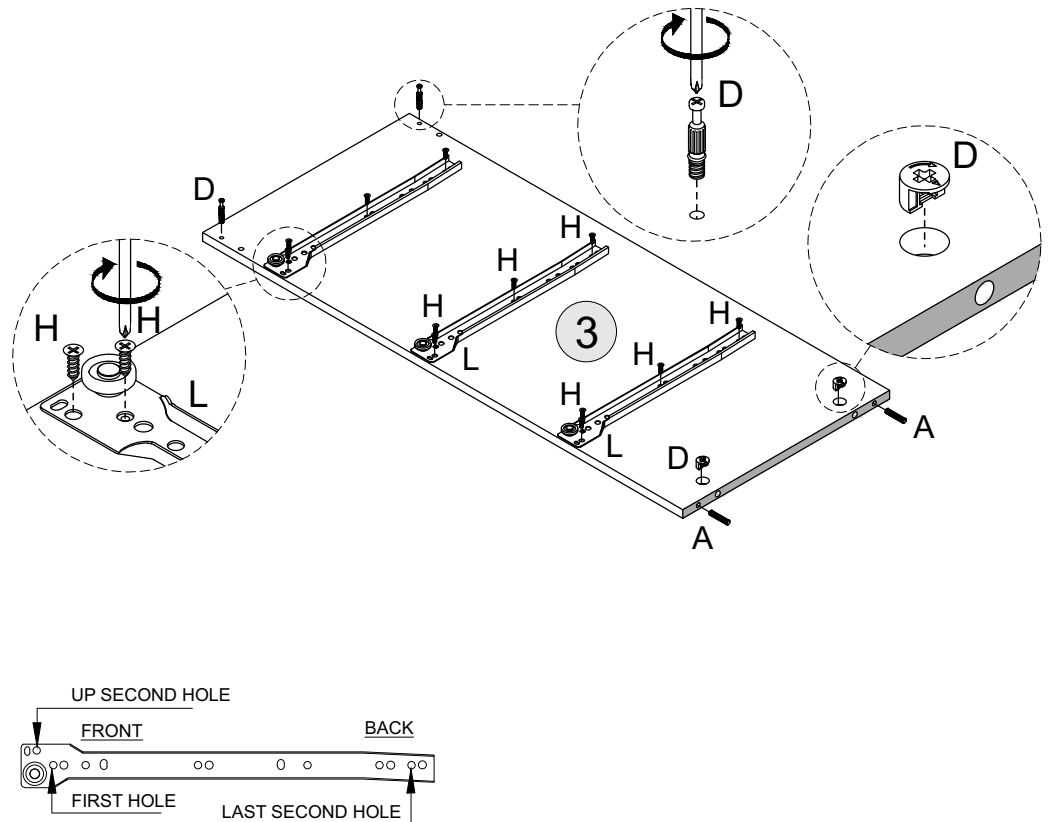
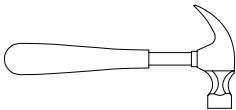
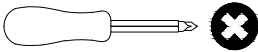

STEP 2

PARTS REQUIRED

1 - SIDE PANEL - LEFT x1

HARDWARE REQUIRED

A  02

D  02

H  12

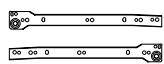
L  03

TOOLS REQUIRED

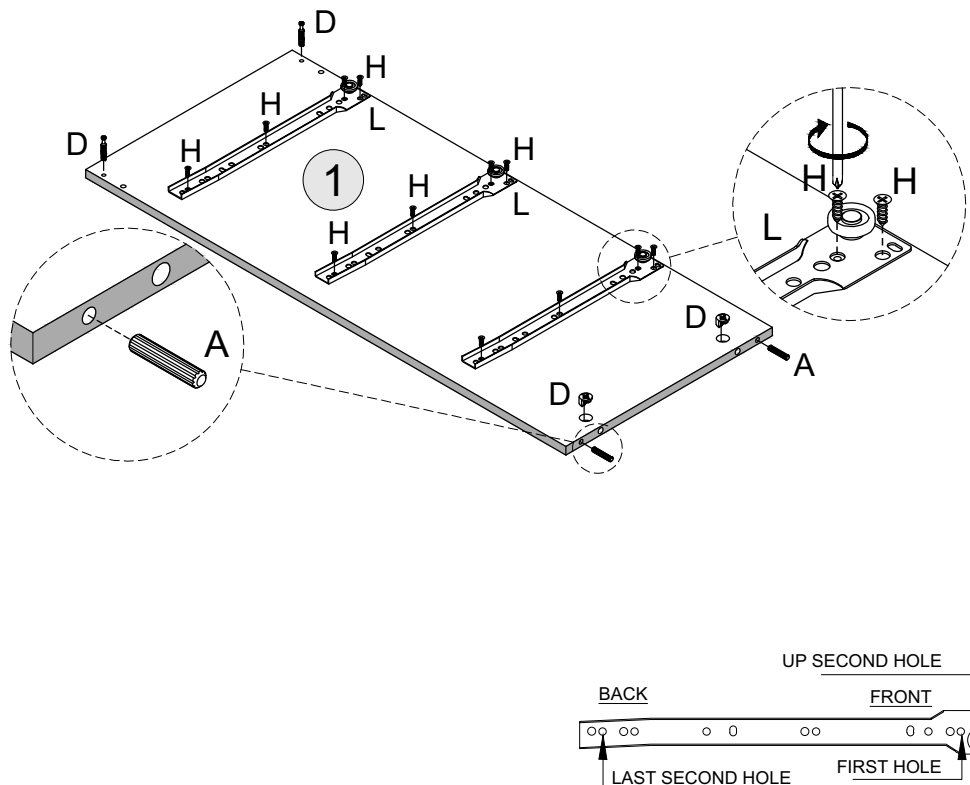
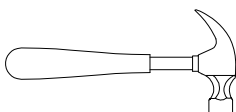

STEP 3

PARTS REQUIRED

4 - CENTRE PANEL x1

HARDWARE REQUIRED

A  02

D  02

H  12

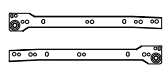
L  03

TOOLS REQUIRED

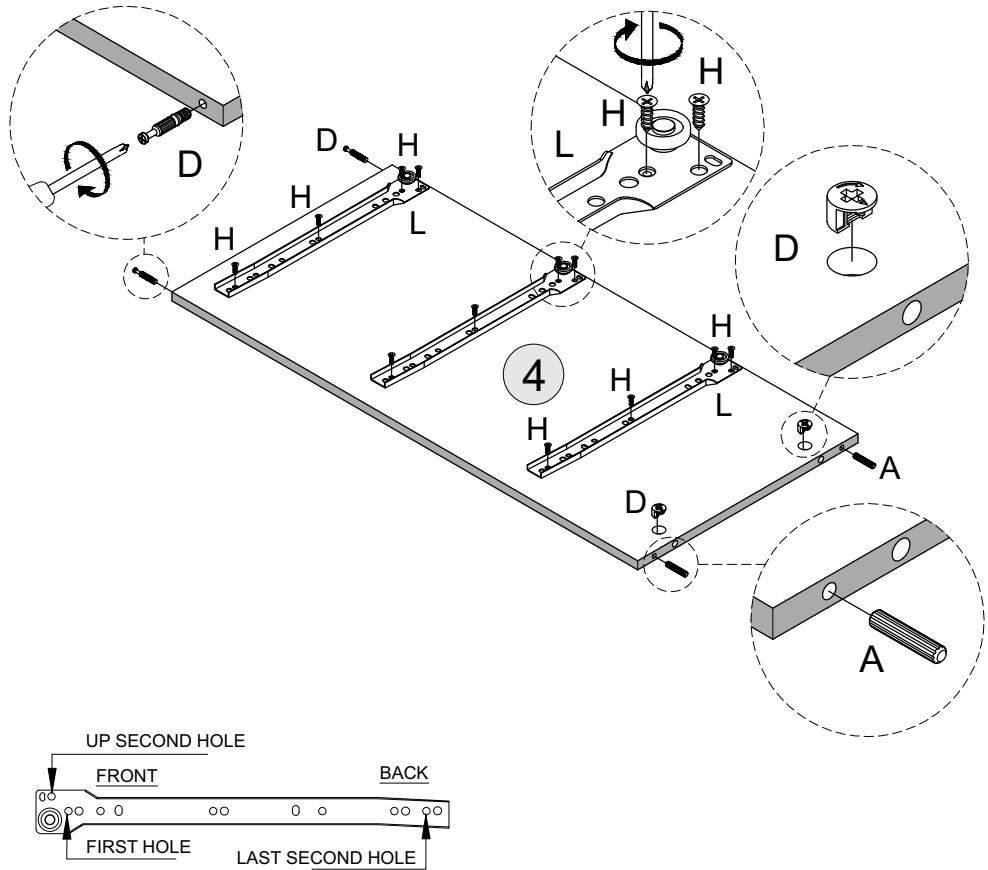
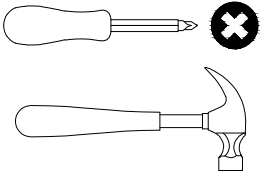

STEP 4

PARTS REQUIRED

4 - CENTRE PANEL x1

HARDWARE REQUIRED

H  12

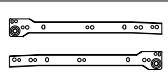
L  03

TOOLS REQUIRED

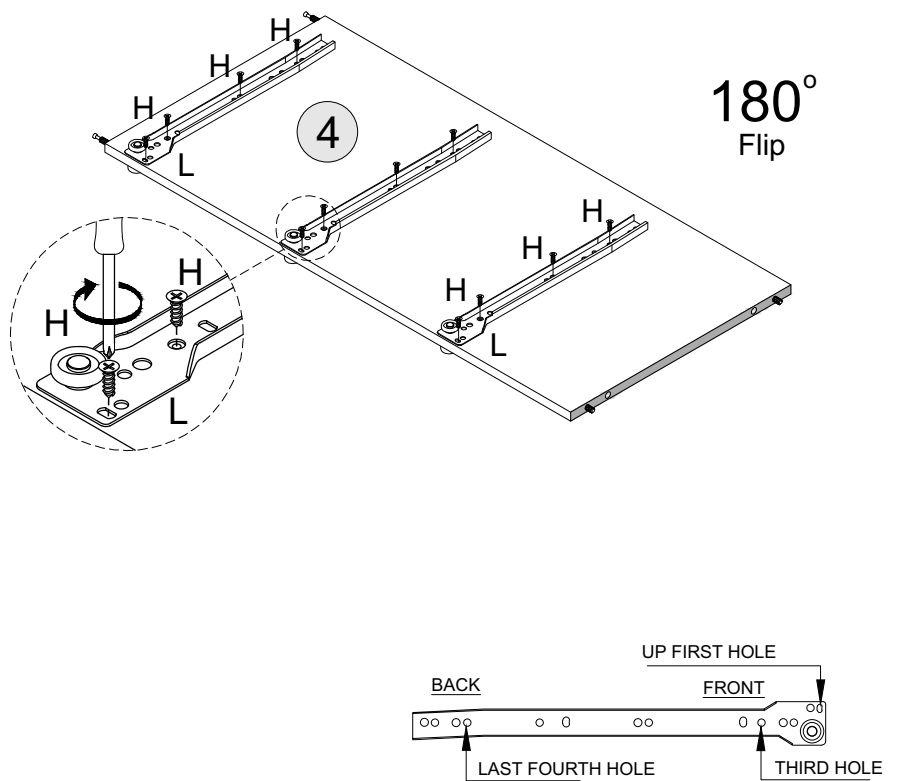
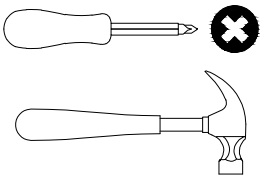



STEP 5

PARTS REQUIRED

2 - BASE APRON	x2
5 - TOP PANEL	x1

HARDWARE REQUIRED

A		04
D		06

TOOLS REQUIRED

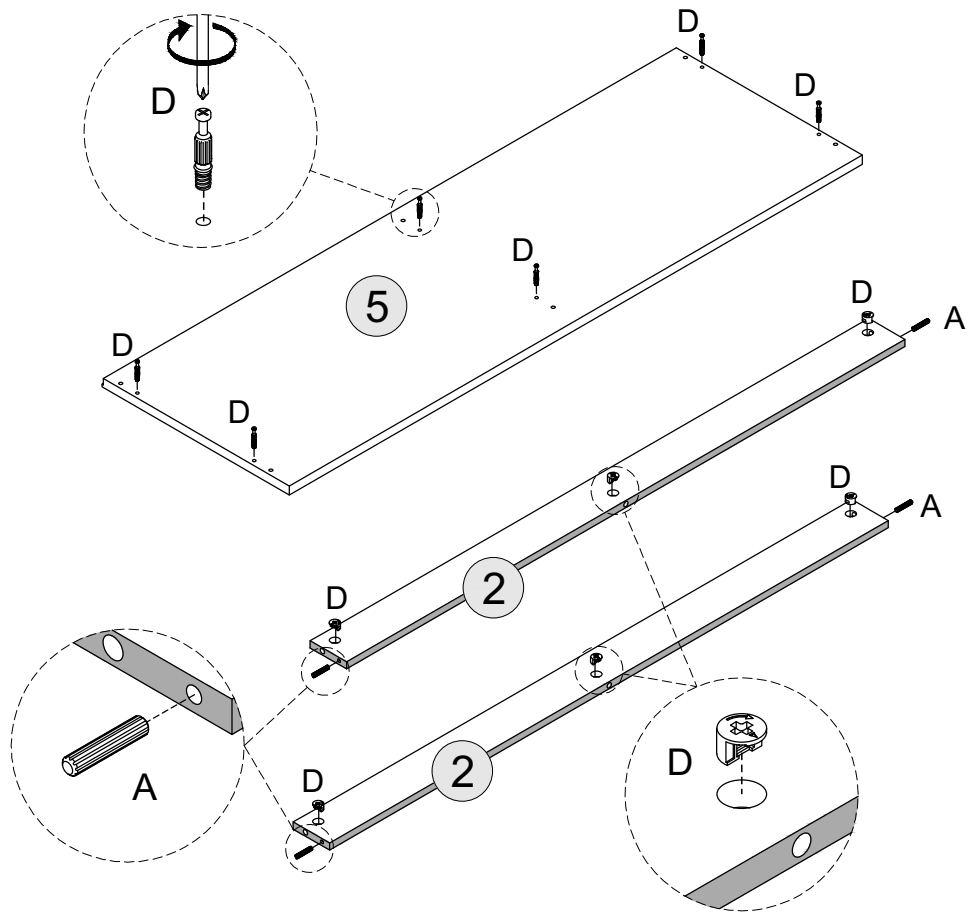
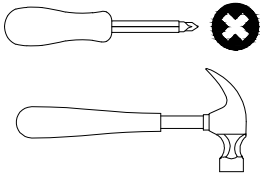

STEP 6

PARTS REQUIRED

1 - SIDE PANEL - LEFT	x1
2 - BASE APRON	x1
3 - SIDE PANEL - RIGHT	x1

HARDWARE REQUIRED

TOOLS REQUIRED

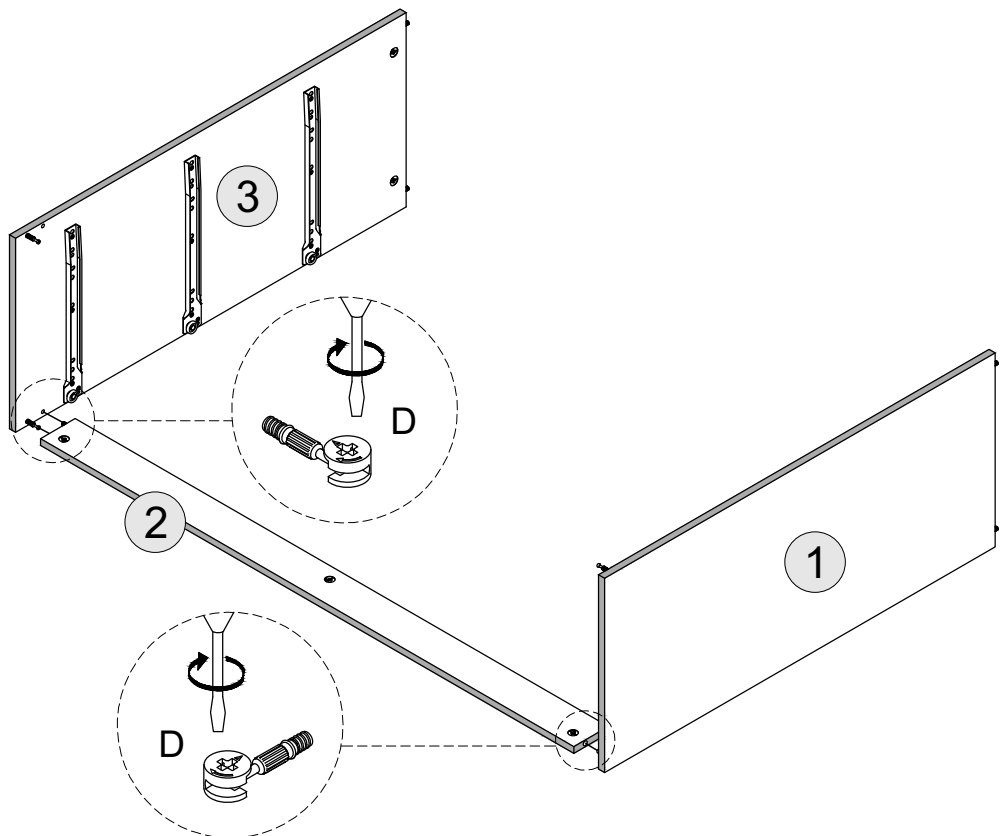
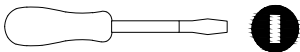

STEP 7

PARTS REQUIRED

2 - BASE APRON x1

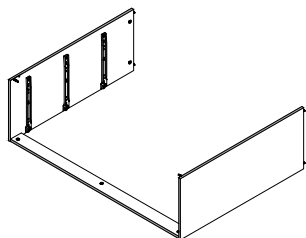

HARDWARE REQUIRED

TOOLS REQUIRED

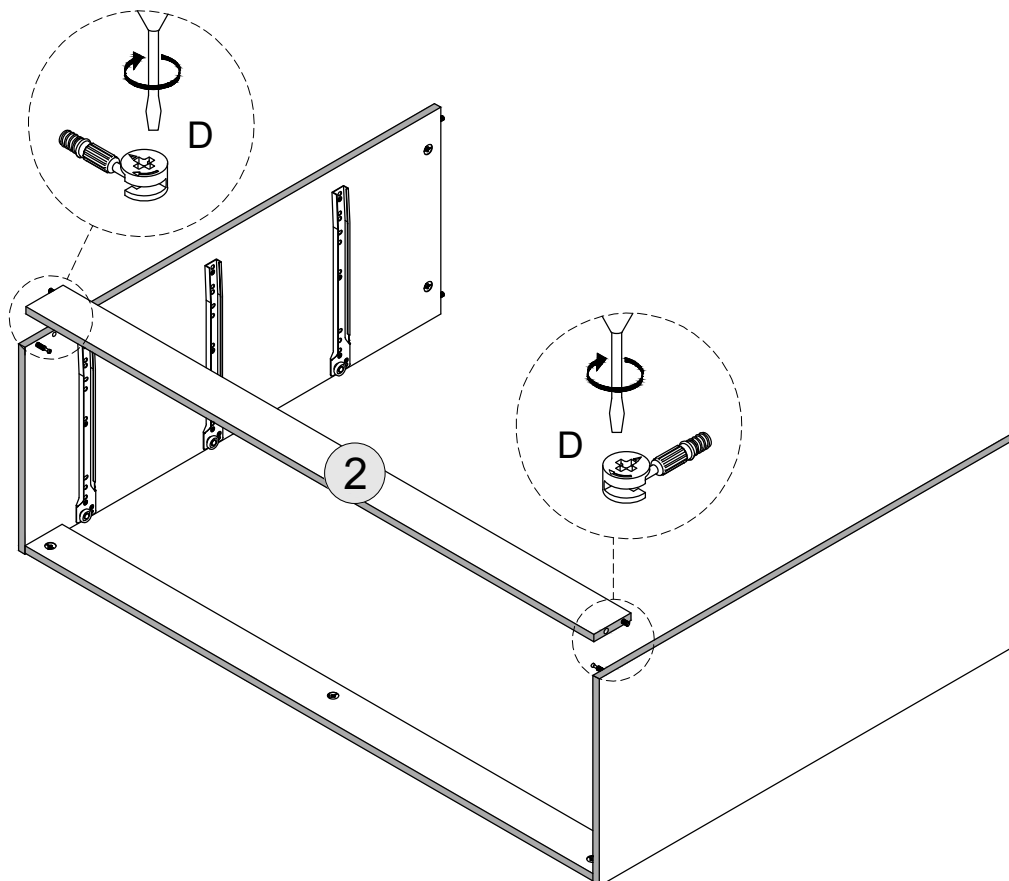
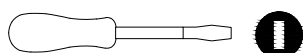

STEP 8

PARTS REQUIRED

4 - CENTRE PANEL x1

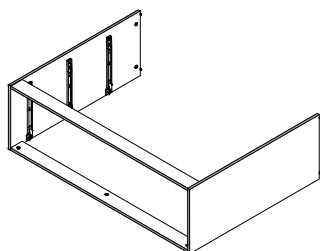

HARDWARE REQUIRED

TOOLS REQUIRED

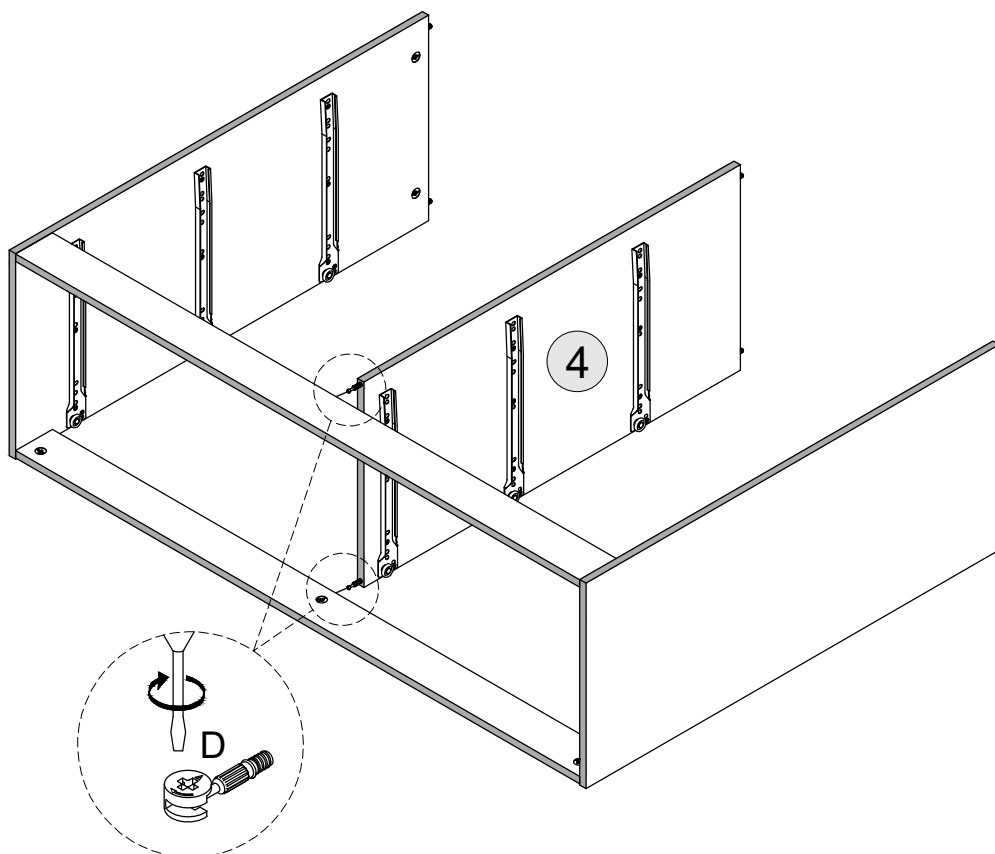
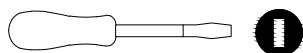

STEP 9

PARTS REQUIRED

5 - TOP PANEL x1

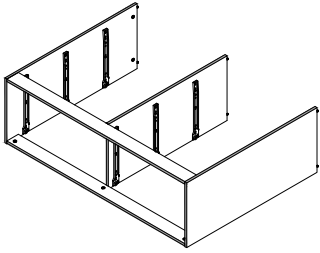

HARDWARE REQUIRED

TOOLS REQUIRED

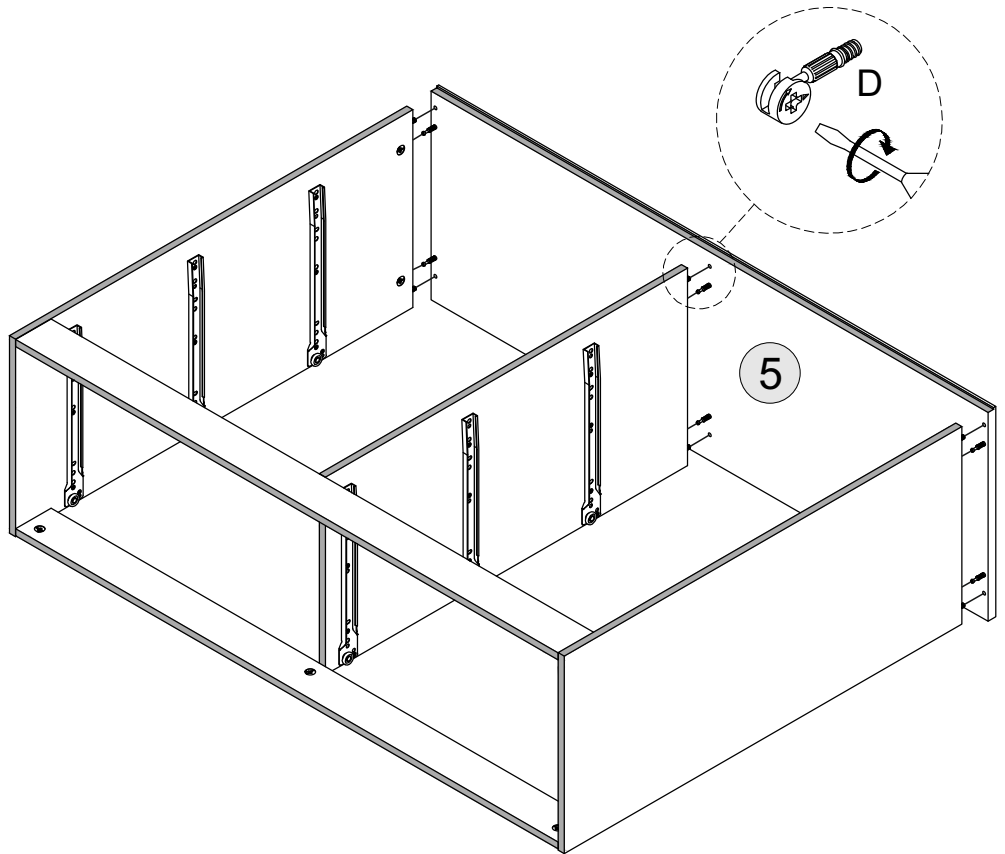
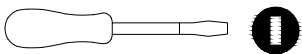

STEP 10

PARTS REQUIRED

6 - BACK PANEL x2

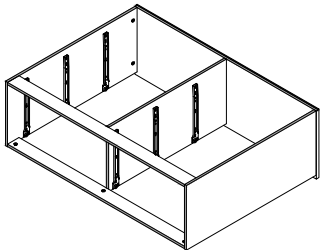

HARDWARE REQUIRED

G  20

H  08

J  01

K  06

TOOLS REQUIRED

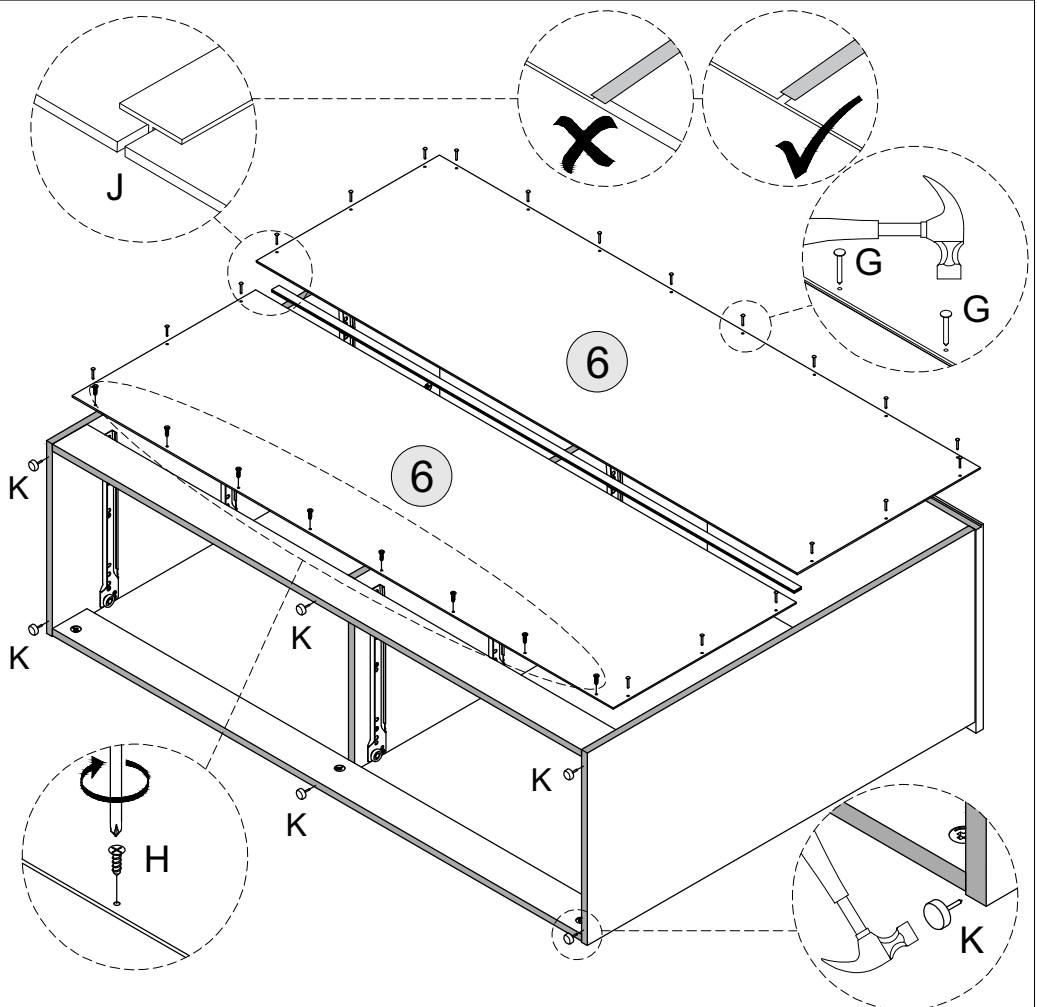
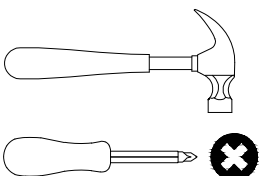



STEP 11

PARTS REQUIRED

7 - DRAWER BACK	x6
8 - DRAWER SIDE - LEFT	x6
9 - DRAWER SIDE - RIGHT	x6
10 - DRAWER FRONT - LEFT	x3
12 - DRAWER FRONT - RIGHT	x3

HARDWARE REQUIRED

A		48
B		12
D		12

TOOLS REQUIRED

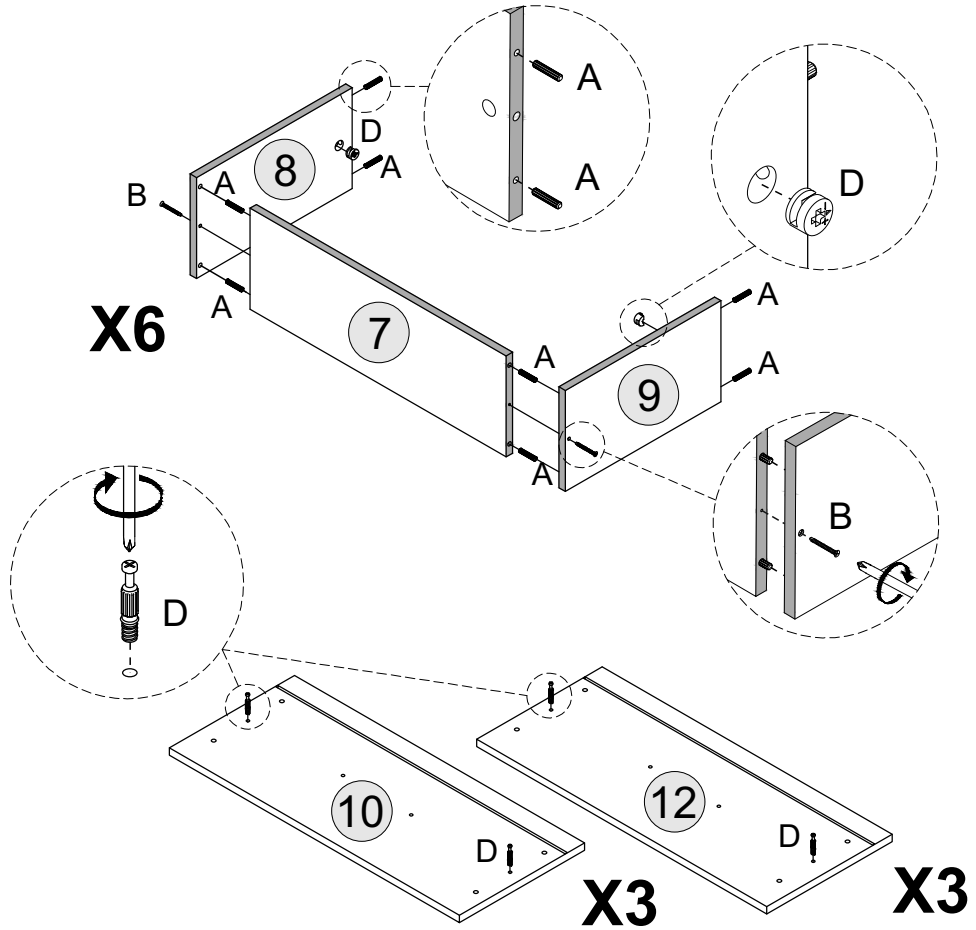
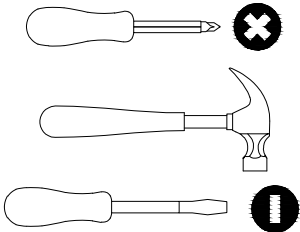



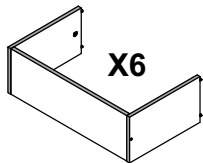

STEP 12

PARTS REQUIRED

10 - DRAWER FRONT - LEFT	x3
11 - DRAWER BASE	x6
12 - DRAWER FRONT - RIGHT	x3



HARDWARE REQUIRED

E		06
F		12
G		36
P		24

TOOLS REQUIRED

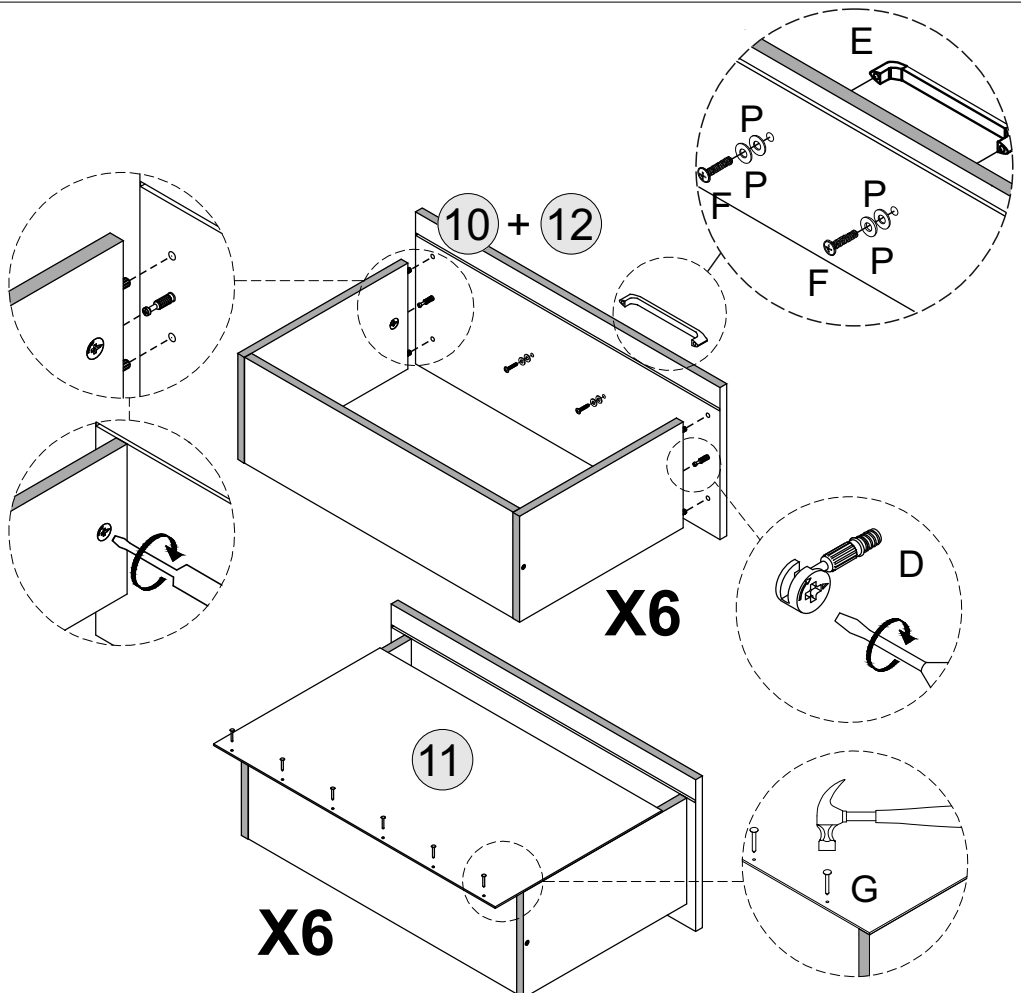
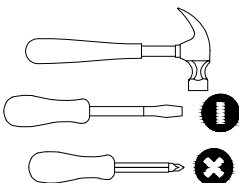

STEP 13

PARTS REQUIRED

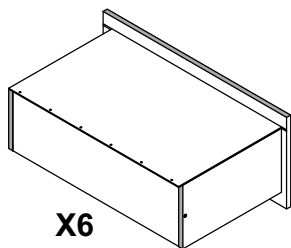

HARDWARE REQUIRED

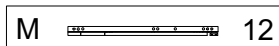
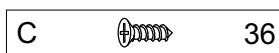

TOOLS REQUIRED

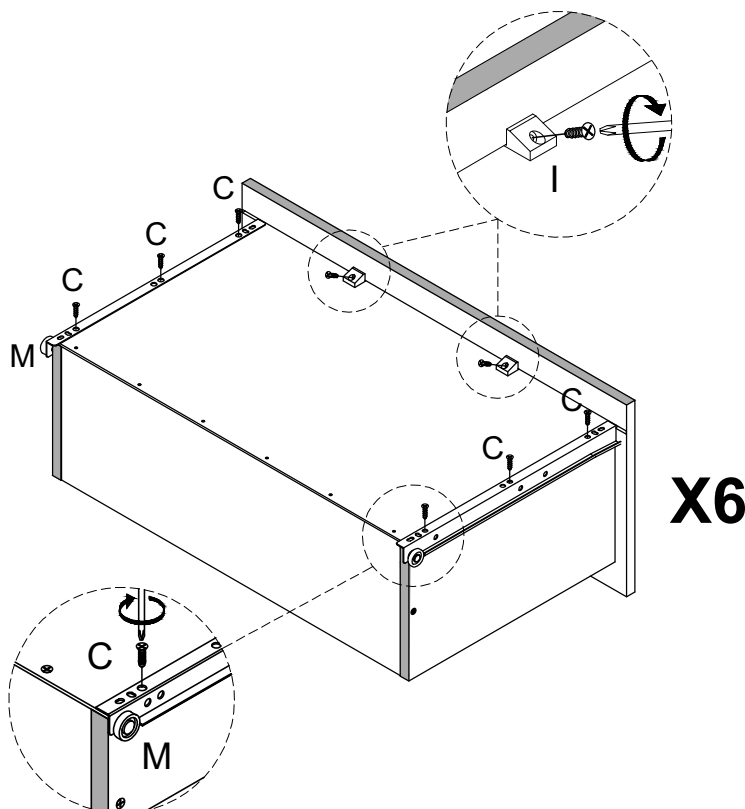
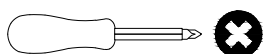

STEP 14

PARTS REQUIRED

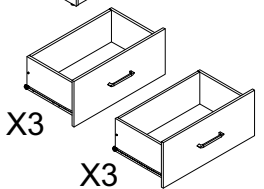
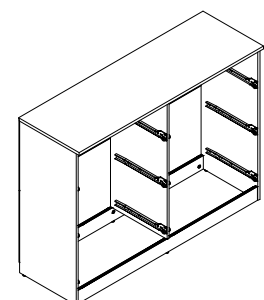

HARDWARE REQUIRED

TOOLS REQUIRED

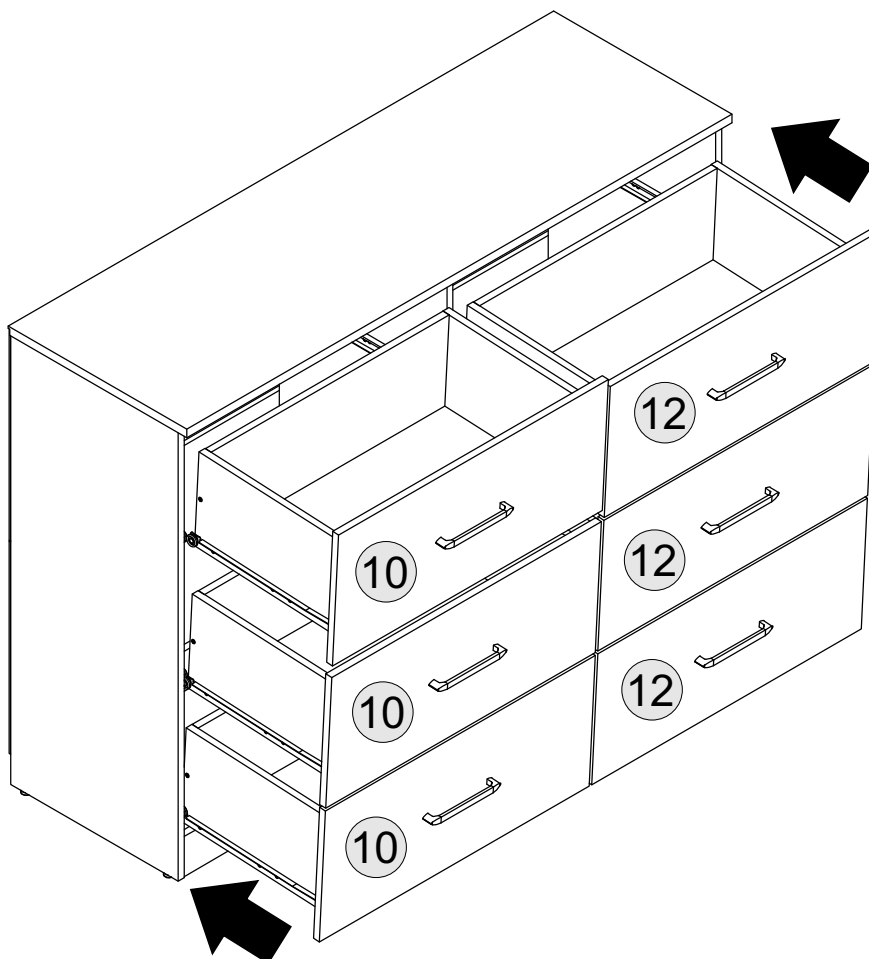

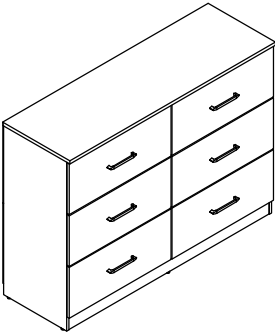
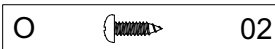
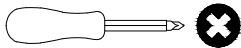
STEP 15PARTS REQUIREDHARDWARE REQUIREDTOOLS REQUIRED**WARNING**

Serious or fatal injuries can occur from furniture tipping over. To prevent the furniture from tipping over we recommend that it is permanently fixed to the wall.

Wall fixings are not supplied with this product as different wall materials require different types of fixing devices. Please make sure you use fixings suitable for the walls in your home.

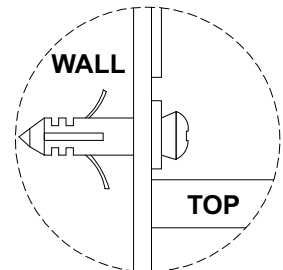
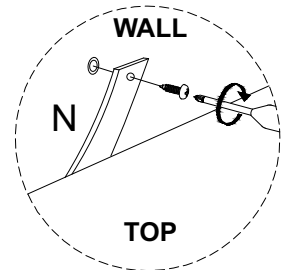
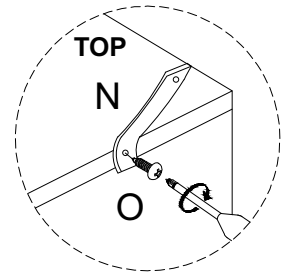
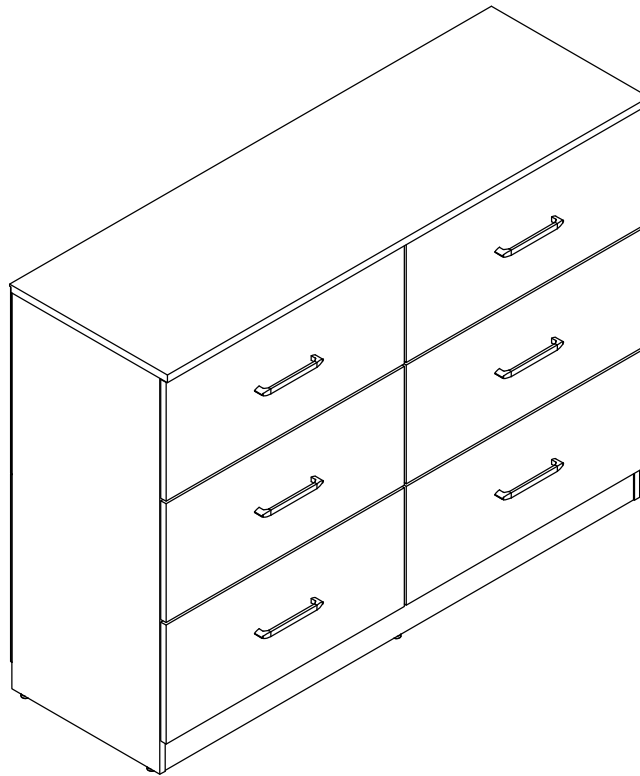

INFORMATIONS IMPORTANTES (FRENCH)	INFORMACIÓN IMPORTANTE (SPANISH)
<p style="text-align: center;">IMPORTANTE POUR USAGE DOMESTIQUE UNIQUEMENT VEUILLEZ LIRE AVANT DE CONTINUER</p> <p>Le produit que vous avez acheté vous offrira de nombreuses années de service si vous suivez les directives pour son assemblage sûr et son entretien et nettoyage périodiques. Assemblez sur une surface douce et propre. N'utilisez aucun autre outil que ceux illustrés. Toutes les clés ou clés Allen nécessaires sont fournies avec le kit de fixation. N'utilisez en aucun cas un outil électrique pour assembler ce produit. Son utilisation invalidera toute réclamation que vous pourriez avoir et pourrait rendre ce produit dangereux. Selon la quantité d'utilisation de ce produit, il peut être nécessaire de resserrer les fixations de temps en temps. Cela est tout à fait normal pour tout meuble en kit. Ne serrez pas trop les fixations. Pour le nettoyage, vous pouvez utiliser un chiffon humide (pas mouillé). N'utilisez pas de produits de polissage, de détergent ou de nettoyeurs chimiques. La surface de cet article n'est pas résistante à la chaleur. Utilisez toujours un set de table sous les articles chauds ou froids pour éviter les marques.</p> <p style="text-align: center;">ADVERTENCIA (ANTI-BASCULEMENT)</p> <p>Des blessures graves, voire mortelles, peuvent survenir en cas de basculement d'un meuble. Pour éviter que le meuble ne bascule, nous recommandons de le fixer de manière permanente au mur.</p> <p>Les fixations murales ne sont pas fournies avec ce produit, car les différents matériaux de mur nécessitent différents types de dispositifs de fixation. Veuillez vous assurer d'utiliser des fixations adaptées aux murs de votre maison. Veuillez vous référer à la dernière page.</p>	<p style="text-align: center;">IMPORTANTE SOLO PARA USO DOMÉSTICO LEER ANTES DE CONTINUAR</p> <p>El producto que ha adquirido le brindará muchos años de servicio si sigue las pautas para su montaje seguro y su mantenimiento y limpieza periódicos. Ensamble sobre una superficie suave y limpia. No utilice herramientas distintas a las que se muestran. Las llaves inglesas o llaves Allen necesarias se incluyen con el kit de accesorios. No utilice bajo ningún concepto una herramienta eléctrica para ensamblar este producto. Su uso invalidará cualquier reclamo que pueda tener y podría hacer que este producto sea inseguro. Dependiendo de la cantidad de uso que reciba este producto, puede ser necesario apretar las fijaciones de vez en cuando. Esto es completamente normal para cualquier mueble en paquete plano. No apriete demasiado las fijaciones. Para la limpieza, puede utilizar un paño húmedo (no mojado). No utilice abrillantadores, detergentes ni limpiadores químicos. La superficie de este artículo no es resistente al calor. Utilice siempre un mantel individual debajo de los elementos calientes o fríos para evitar marcarlos.</p> <p style="text-align: center;">ADVERTENCIA (ANTI-VUELCO)</p> <p>El vuelco de los muebles puede provocar lesiones graves o fatales. Para evitar que los muebles se vuelquen, recomendamos fijarlos permanentemente a la pared.</p> <p>Este producto no incluye fijaciones de pared, ya que los distintos materiales de pared requieren distintos tipos de dispositivos de fijación. Asegúrese de utilizar fijaciones adecuadas para las paredes de su hogar. Veuillez vous référer à la dernière page.</p>
<p style="text-align: center;">WICHTIGE INFORMATIONEN (GERMAN)</p>	<p style="text-align: center;">INFORMAZIONI IMPORTANTI (ITALIAN)</p>
<p style="text-align: center;">WICHTIGUR FÜR DEN HAUSHALTSGEBRAUCH BITTE LESEN SIE, BEVOR SIE FORTFAHREN</p> <p>Das von Ihnen gekaufte Produkt wird Ihnen viele Jahre lang gute Dienste leisten, wenn Sie die Richtlinien für eine sichere Montage und regelmäßige Wartung und Reinigung befolgen. Montieren Sie es auf einer weichen, sauberen Oberfläche. Verwenden Sie keine anderen Werkzeuge als die abgebildeten. Erforderliche Schraubenschlüssel oder Inbusschlüssel sind im Montagesatz enthalten. Verwenden Sie unter keinen Umständen ein Elektrowerkzeug zur Montage dieses Produkts. Bei Verwendung erlöschen alle Ansprüche, die Sie haben, und das Produkt kann unsicher werden. Je nachdem, wie häufig dieses Produkt verwendet wird, kann es erforderlich sein, die Befestigungen von Zeit zu Zeit festzuziehen. Dies ist bei Möbeln aus dem Bausatz völlig normal. Ziehen Sie die Befestigungen nicht zu fest an. Zum Reinigen können Sie ein feuchtes Tuch verwenden (nicht nass). Verwenden Sie keine Politur, kein Reinigungsmittel oder chemische Reiniger. Die Oberfläche dieses Artikels ist nicht hitzebeständig. Verwenden Sie immer eine Unterlage unter heißen oder kalten Gegenständen, um Flecken zu vermeiden.</p> <p style="text-align: center;">WARNUNG (KIPPSCHUTZ)</p> <p>Durch das Umkippen von Möbeln können schwere oder tödliche Verletzungen entstehen. Um ein Umkippen der Möbel zu verhindern, empfehlen wir, diese dauerhaft an der Wand zu befestigen.</p> <p>Wandbefestigungen werden nicht mit diesem Produkt mitgeliefert, da unterschiedliche Wandmaterialien unterschiedliche Arten von Befestigungsvorrichtungen erfordern. Bitte stellen Sie sicher, dass Sie Befestigungen verwenden, die für die Wände in Ihrem Zuhause geeignet sind. Bitte beachten Sie die letzte Seite.</p>	<p style="text-align: center;">IMPORTANTE, SOLO PER USO DOMESTICO SI PREGA DI LEGGERE PRIMA DI CONTINUARE OLTRE</p> <p>Il prodotto che hai acquistato ti garantirà molti anni di servizio se seguire le linee guida per il suo montaggio sicuro e periodico manutenzione e pulizia. Montare su una superficie morbida e pulita. Non utilizzare strumenti diversi da quelli mostrati. Eventuali chiavi e chiavi a brugola necessarie sono incluse nel kit di raccordi. Non utilizzare per nessun motivo un utensile elettrico per assemblare questo prodotto. Suo l'uso invaliderà qualsiasi reclamo tu possa avere e potresti avanzare su questo prodotto pericoloso. A seconda della quantità di utilizzo che questo prodotto riceve, potrebbe essere necessario stringere di tanto in tanto i fissaggi. Questo è completamente normalmente per qualsiasi mobile flat pack. Non stringere eccessivamente il fissaggio. Per la pulizia è possibile utilizzare un panno umido (non bagnato). Non usare smalti, detersivi o detergenti chimici. La superficie di questo articolo non è resistente al calore. Usa sempre una tovaglietta sotto oggetti caldi o freddi per evitare segni.</p> <p style="text-align: center;">AVVERTIMENTO (ANTIRIBALTAMENTO)</p> <p>Il ribaltamento dei mobili può provocare lesioni gravi e mortali. A evitare che i mobili si ribaltino, si consiglia di farlo fissato permanentemente al muro.</p> <p>I fissaggi a parete non sono forniti con questo prodotto in quanto parete diversa i materiali richiedono diversi tipi di dispositivi di fissaggio. Per favore, fallo assicurati di utilizzare fissaggi adatti alle pareti della tua casa. Si prega di fare riferimento all'ultima pagina.</p>