

NEVADA 3 DRAWER BEDSIDE ASSEMBLY INSTRUCTIONS WHITE GLOSS

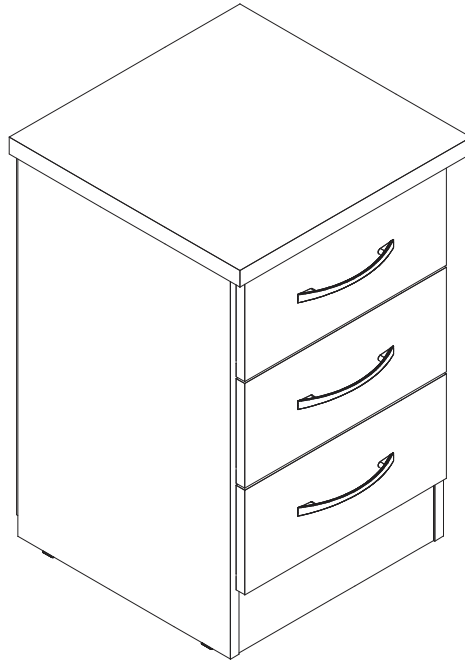

IMPORTANT FOR DOMESTIC USE ONLY

PLEASE READ BEFORE YOU CONTINUE FURTHER

CARE AND MAINTENANCE

After unpacking this product please keep the original packaging in case it needs to be returned for any reason.

- Please ensure all fittings and parts are present before commencing with assembly.
- Never drag or push products as this could cause damage to the joints making it inferior.
- We strongly recommend that you keep children away from your work area.
- We recommend that you lay a blanket or sheet on the floor to avoid damage to both your floor and the product.
- Assemble this product as close to its final position as possible.
- Do not place this product next to a radiator or in direct sunlight.
- Do not drag or push items across your high gloss furniture as this may cause the surface to scratch
- Wood is a natural product and may expand if subjected to damp and may shrink or crack if subjected to heat. Therefore it is recommended that room temperature is maintained, with no sudden temperature fluctuations.
- Make sure any spillage is wiped off immediately.
- Do not place hot or chilled items directly on to the surface, use a place mat or marking will occur.
- For general cleaning use a soft cotton or micro fibre cloth, and do not use detergents of any kind.
- From time to time it may be necessary to tighten fittings, regular inspections should be carried out.
- Do not place on a wet or damp floor as staining may occur to your floor.

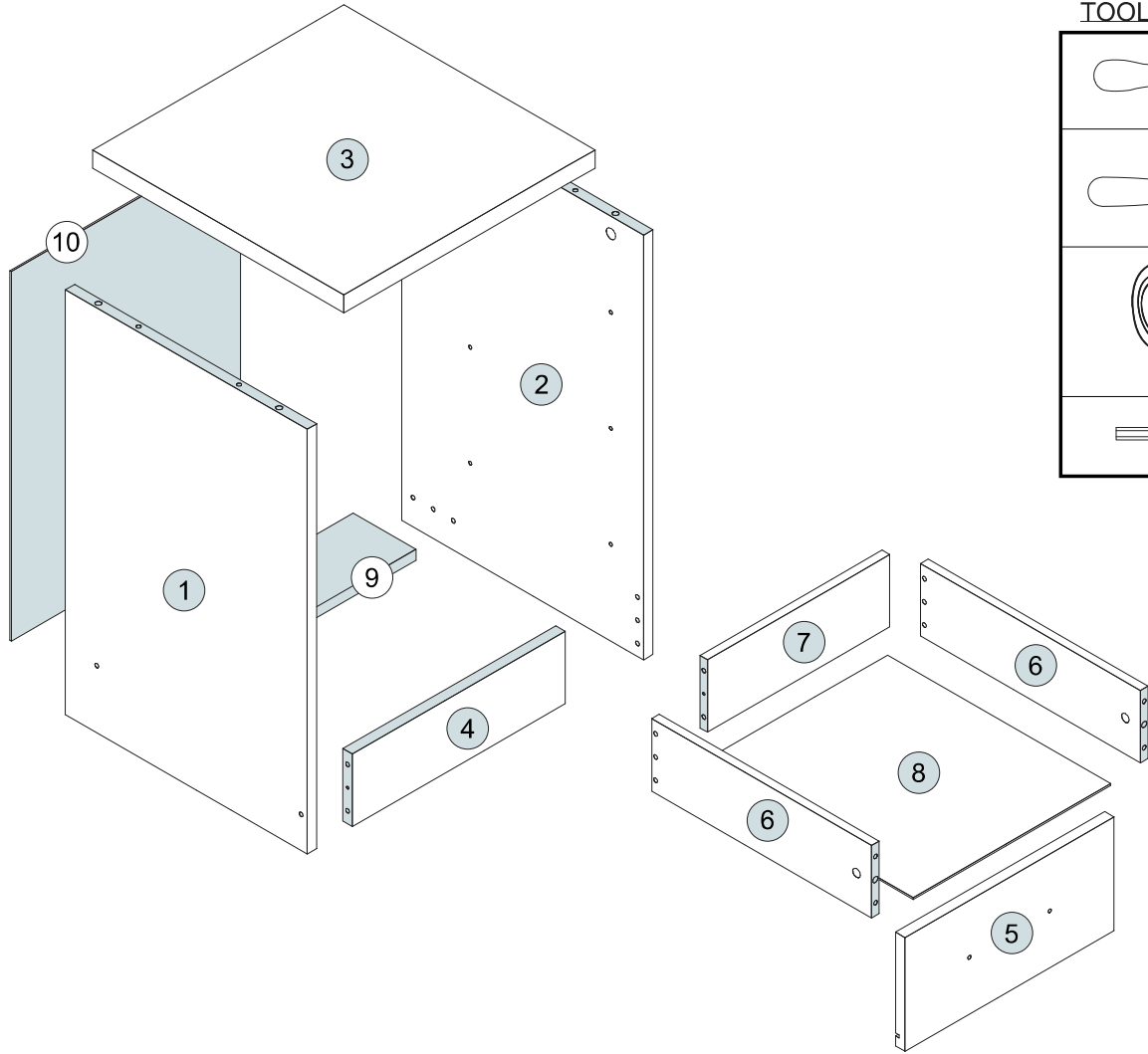

TOOLS REQUIRED

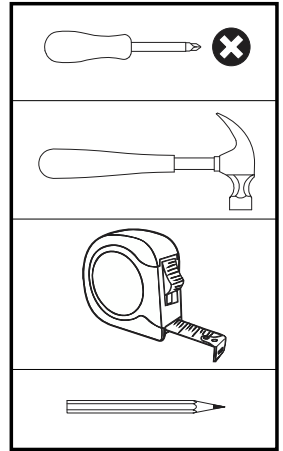









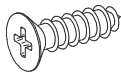
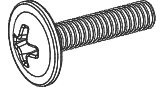

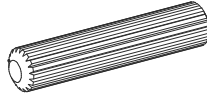

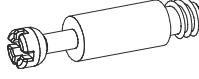
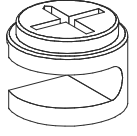
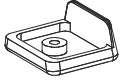
PARTS LIST

Please Note:
The below parts have all been stamped with the part number to help identify them during assembly.

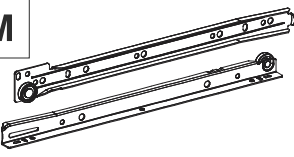
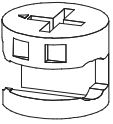
Part Number	Part Code	Part Description	Quantity	Carton
01	S100-103-059-HV1-01	Left Side Panel	1	1/1
02	S100-103-059-HV1-02	Right Side Panel	1	1/1
03	S100-103-059-HV1-03	Top Panel	1	1/1
04	S100-103-059-HV1-04	Front Baseboard	1	1/1
05	S100-103-059-HV1-05	Drawer Front	3	1/1
06	S100-103-059-HV1-06	Drawer Side	6	1/1
07	S100-103-059-HV1-07	Drawer Back Panel	3	1/1
08	S100-103-059-HV1-08	Drawer Bottom	3	1/1
09	S100-103-059-HV1-09	Back Baseboard	1	1/1
10	S100-103-059-HV1-10	Back Panel	1	1/1

FITTINGS LIST

<p>A</p>  <p>Flat Head Screw 2/+ Ø6,0 x 10mm (12x)</p>	<p>B</p>  <p>Flat Head Screw 2/+ Ø4,0 x 14mm (18x)</p>	<p>C</p>  <p>Flan Head Screw Ø4,0 x 20mm (6x)</p>	<p>D</p>  <p>Flat Head Screw 1/+ Ø4,0 x 50mm (10x)</p>
<p>E</p>  <p>2/+ Dowel Ø6,0 x 30mm (36x)</p>	<p>F</p>  <p>2/+ Nail 10x10 Ringed-1,5x23mm (42x)</p>	<p>G</p>  <p>2/+ Cam Bolt (10x)</p>	<p>H</p>  <p>1/+ Cam Nut Ø12x8 8mm (6x)</p>
<p>I</p>  <p>1/+ Plastic Foot L 19x17x8mm Ø2 (4x)</p>	<p>J</p>  <p>2/+ Hole Plugs 19mm (10x)</p>	<p>K</p>  <p>Glue 10 Gr (2x)</p>	<p>L</p>  <p>Handle (3x)</p>
<p>M</p>  <p>Drawer Runners 350mm (3x)</p>	<p>N</p>  <p>1/+ Cam Nut Ø14,9x11 mm (4x)</p>	<p>O</p>  <p>1/+ Flan Head Screw Ø3,5 x 30mm (1x)</p>	<p>P</p>  <p>Strap 200x20x1MM (1x)</p>
<p>Q</p>  <p>1/+ Washer Ø16x7 (2x)</p>			

TIPS FOR FITTINGS CAM-LOCKS

WHEN FITTING CAM NUT. ENSURE STARTING POSITION IS CORRECT BEFORE YOU INSERT CONNECTING CAM BOLT TURN CLOCKWISE UNTIL SECURE

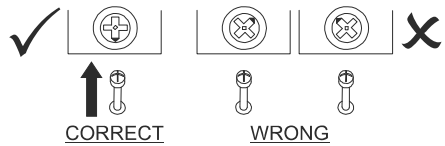

CORRECT WRONG WRONG WRONG

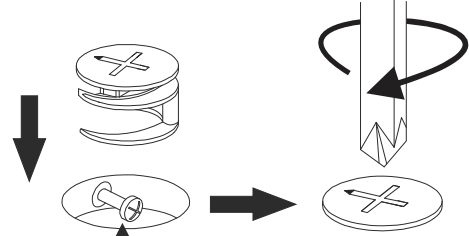

Cam bolt head needs to be in centre

CAMBOLT

Tighten until shoulder in flush with panel. Do not overtighten or undertighten (see example below)

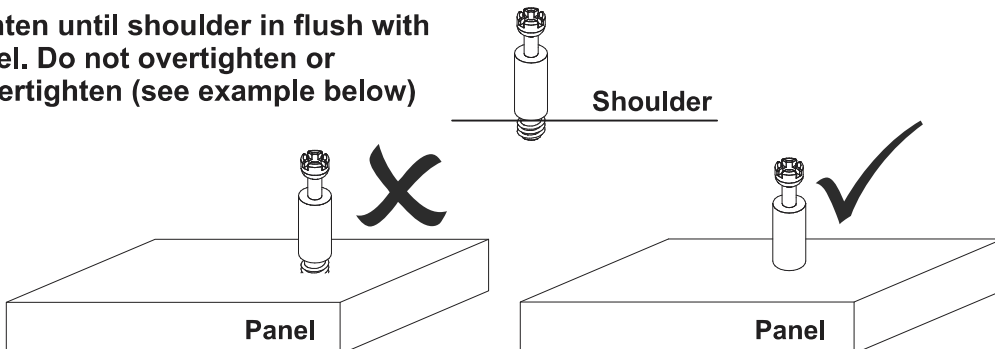

Shoulder

Panel

Panel

STEP 1

PARTS REQUIRED

1 - LEFT SIDE PANEL x1

HARDWARE REQUIRED

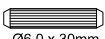
E  02
Ø6,0 x 30mm

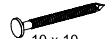
F  02
10 x 10

I  02

K  01
GLUE

TOOLS REQUIRED

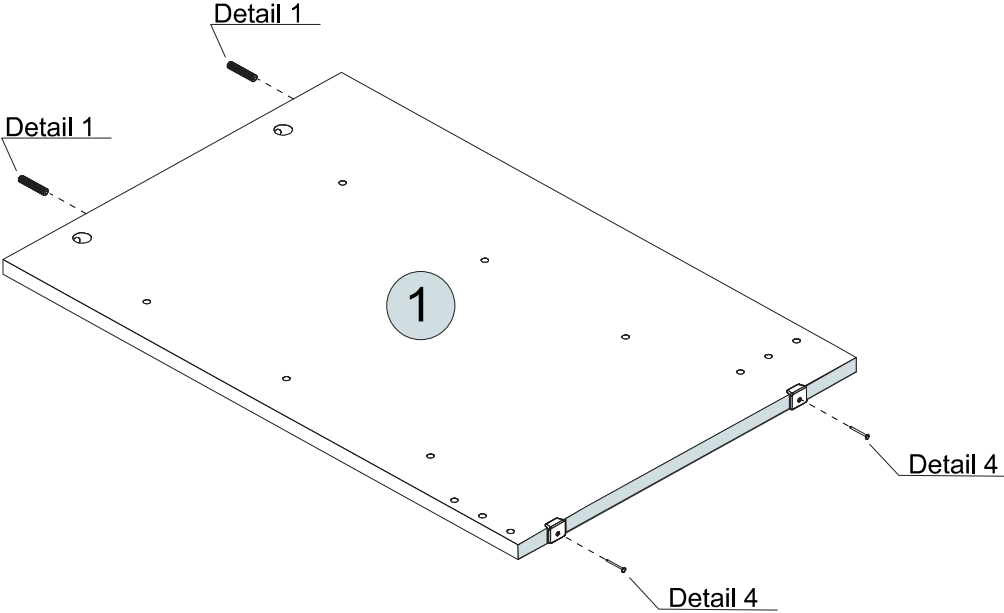
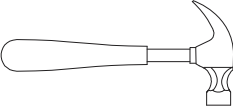

Detail 1

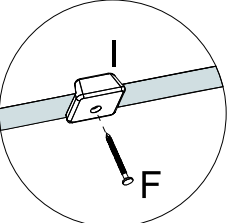

Detail 4

STEP 2

PARTS REQUIRED

2 - RIGHT SIDE PANEL x1

HARDWARE REQUIRED

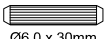
E  02
Ø6,0 x 30mm

F  02
10 x 10

I  02

K  01
GLUE

TOOLS REQUIRED

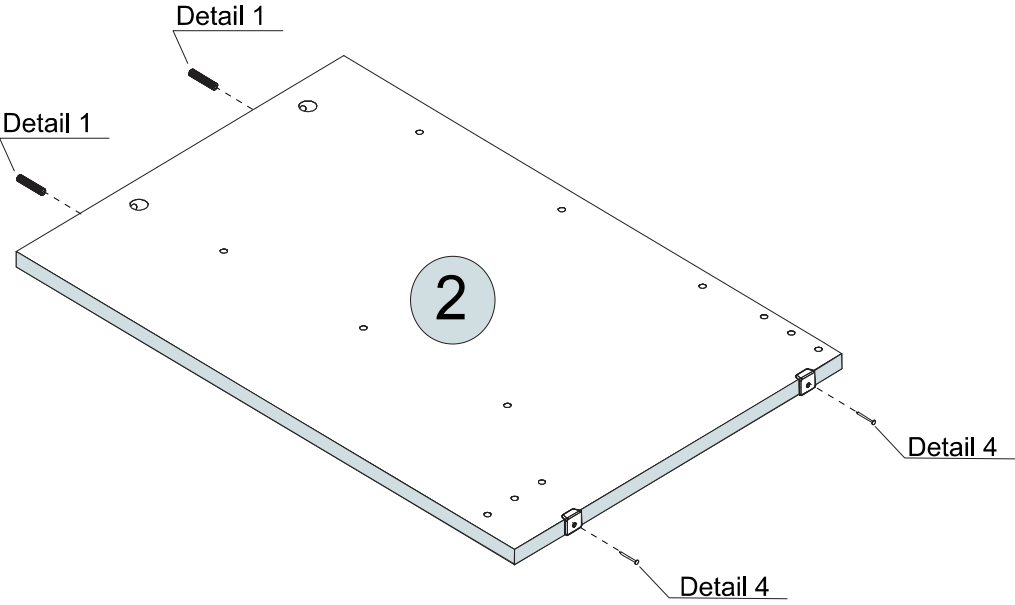
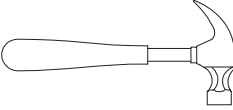

Detail 1

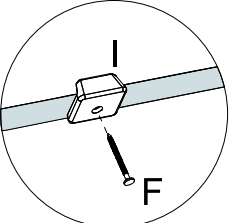

Detail 4

STEP 3

PARTS REQUIRED

2 - RIGHT SIDE PANEL x1

HARDWARE REQUIRED

A  06

B  03

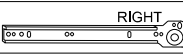
M  03

TOOLS REQUIRED

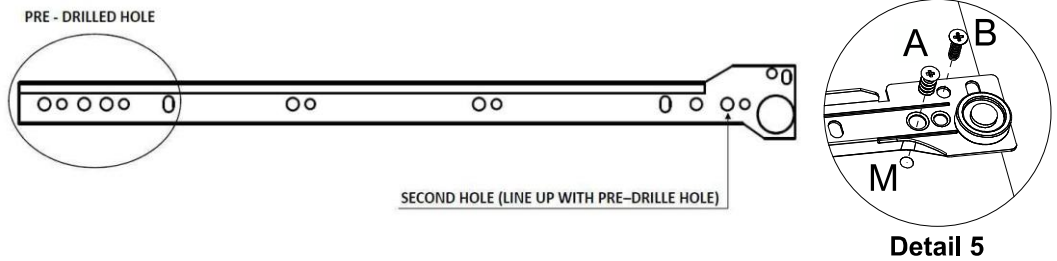
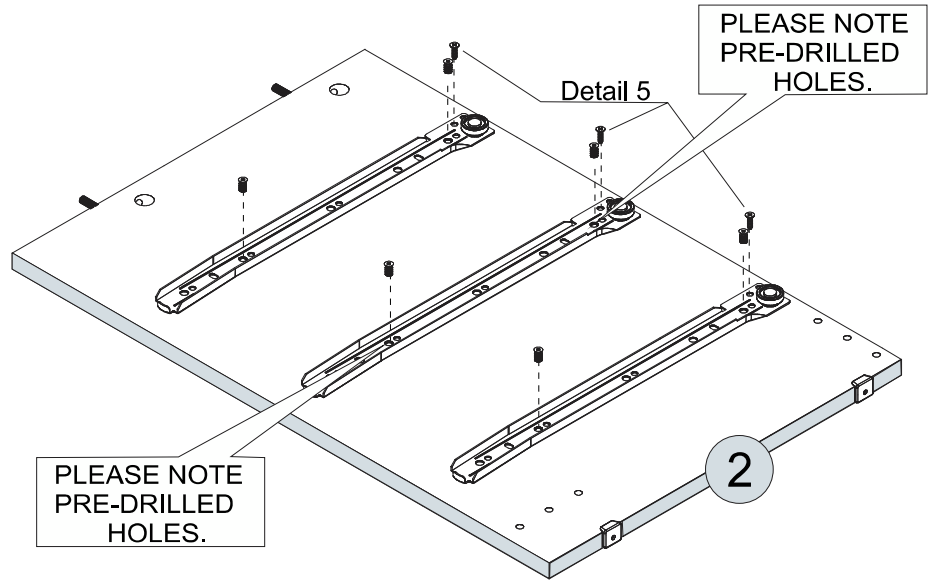
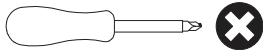



STEP 4

PARTS REQUIRED

1 - LEFT SIDE PANEL x1

HARDWARE REQUIRED

A  06

B  03

M  03

TOOLS REQUIRED

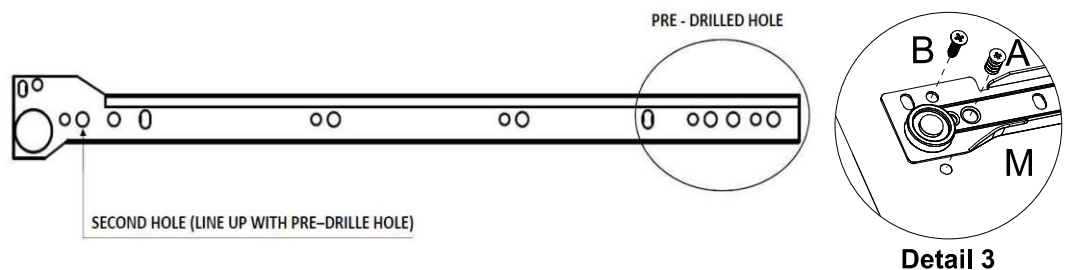
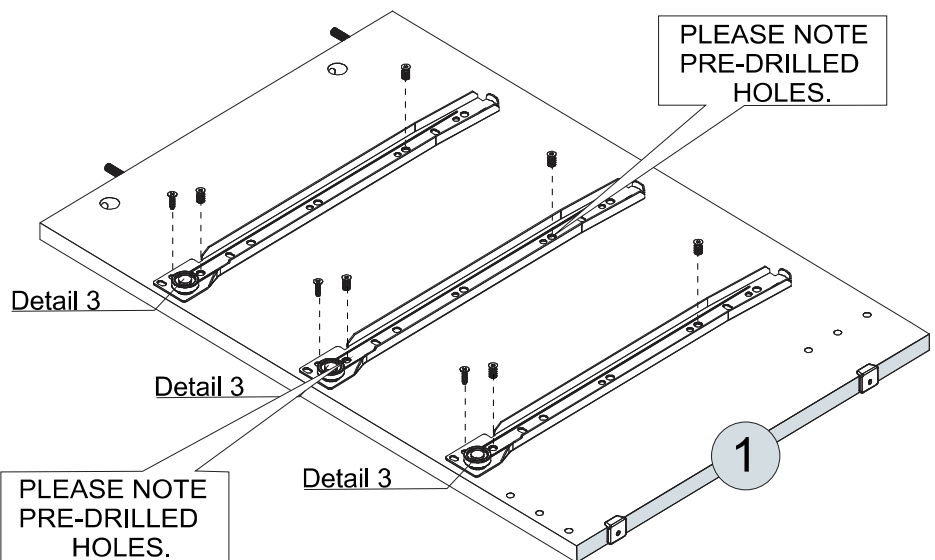
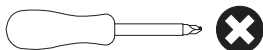

STEP 5

PARTS REQUIRED

9 - BACK BASEBOARD x1

4 - FRONT BASEBOARD x1

HARDWARE REQUIRED

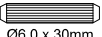
E  08
Ø6,0 x 30mm

K  01
GLUE

TOOLS REQUIRED

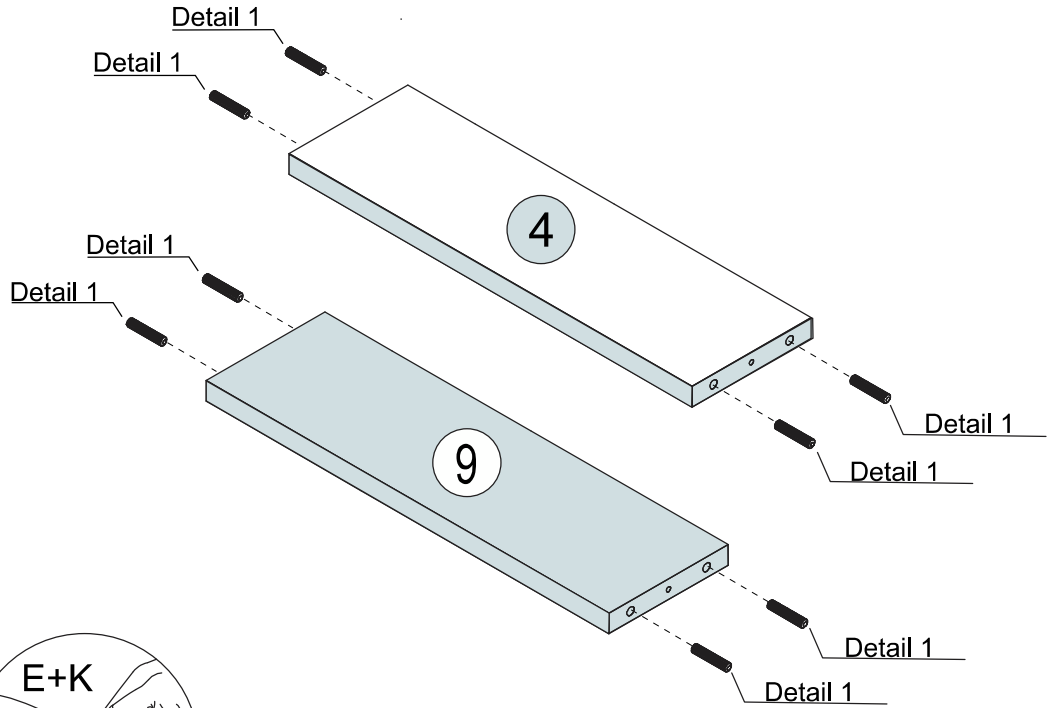

STEP 6

PARTS REQUIRED

2 - RIGHT SIDE PANEL x1

9 - BACK BASEBOARD x1

4 - FRONT BASEBOARD x1

HARDWARE REQUIRED

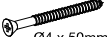
D  02
Ø4 x 50mm

K  01
GLUE

TOOLS REQUIRED

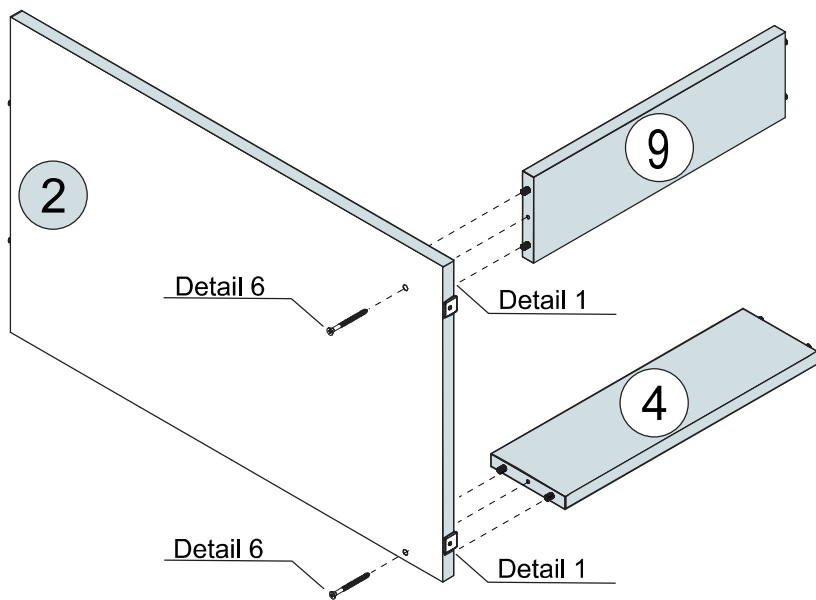
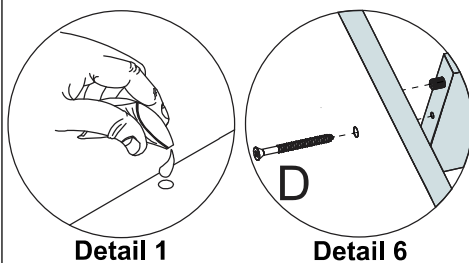
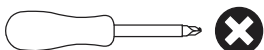

STEP 7

PARTS REQUIRED

1 - LEFT SIDE PANEL x1

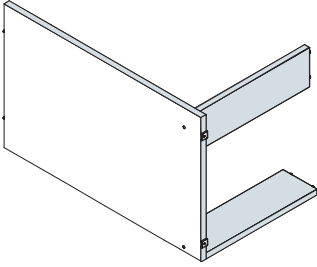

HARDWARE REQUIRED

D  02
Ø4 x 50mm

K  01
GLUE

TOOLS REQUIRED

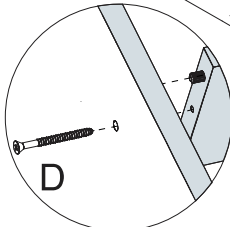
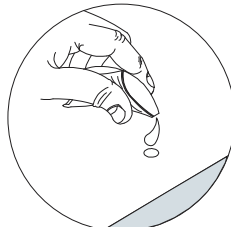
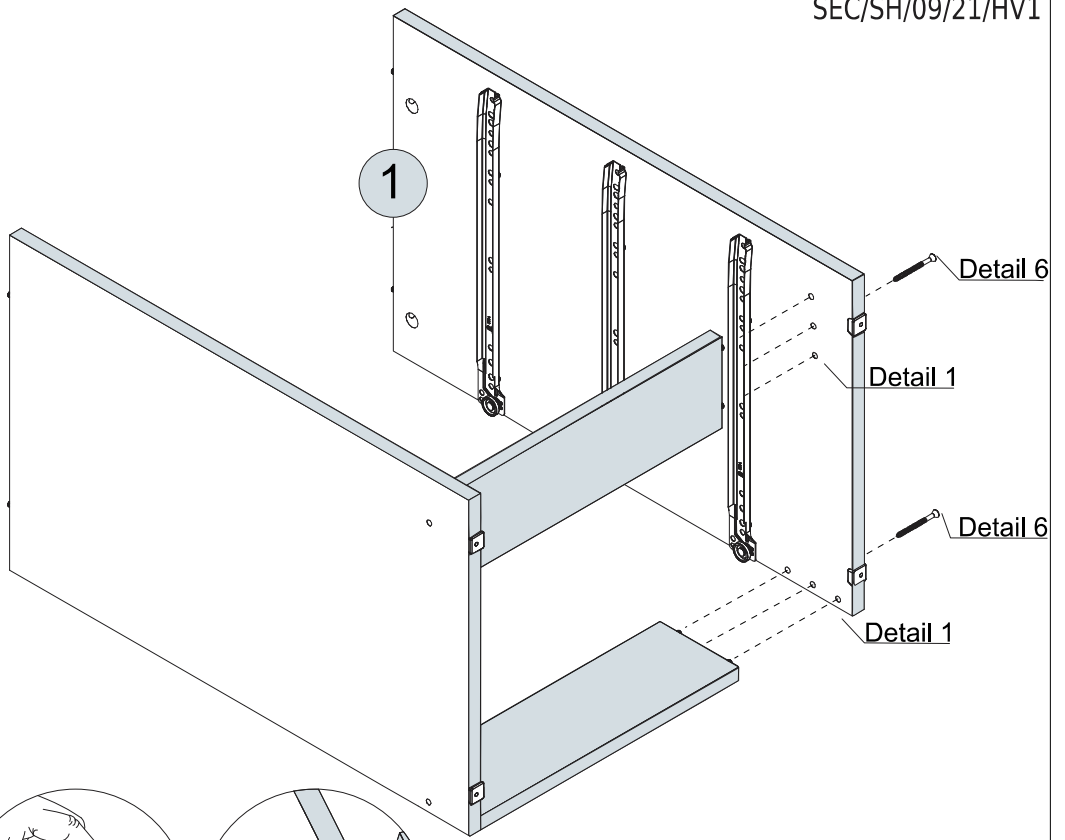
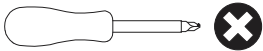

Detail 1

Detail 6

STEP 8

PARTS REQUIRED

3 - TOP PANEL x1

HARDWARE REQUIRED

G  04

TOOLS REQUIRED

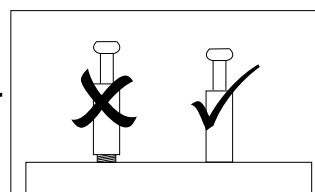
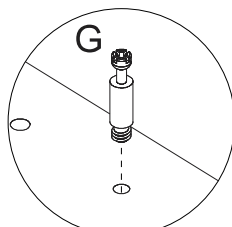
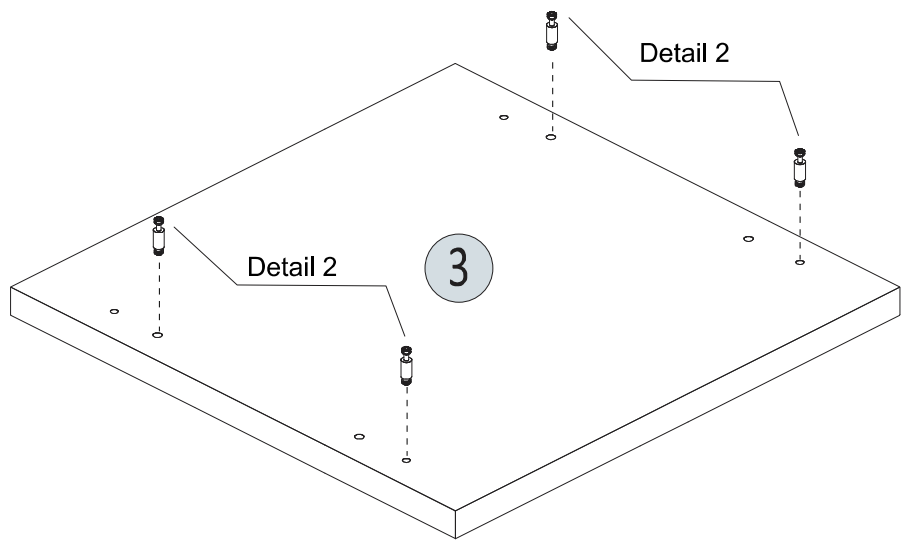
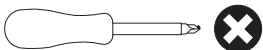

Detail 2

STEP 9

SEC/SH/09/21/HV1

PARTS REQUIRED

3 - TOP PANEL x1

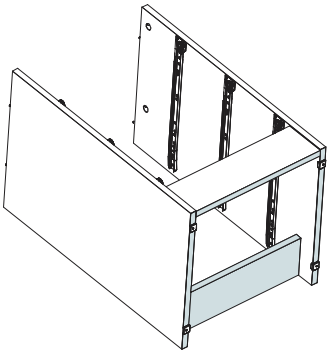

HARDWARE REQUIRED

K  01

N  04

TOOLS REQUIRED

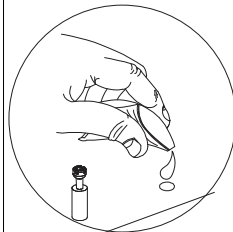
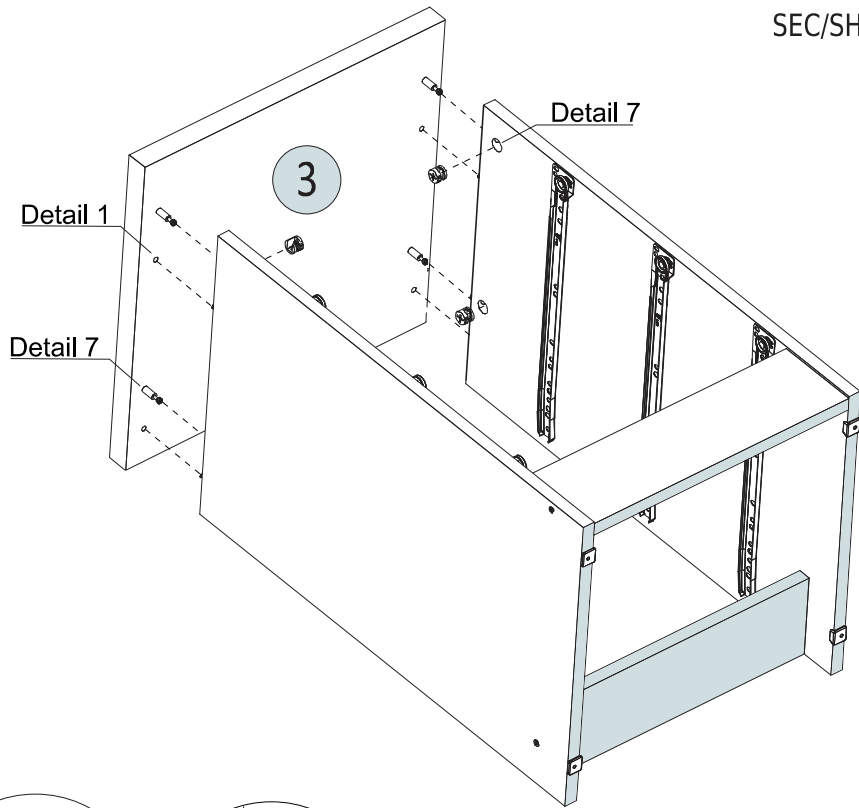
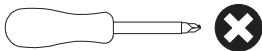

Detail 1

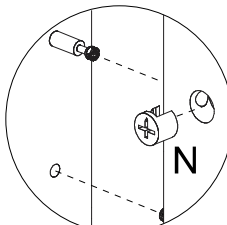

Detail 7

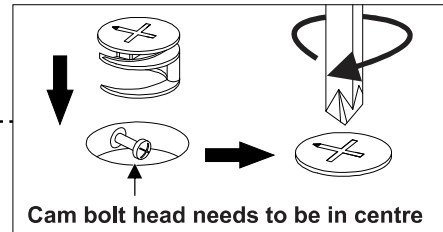

Cam bolt head needs to be in centre

STEP 10

PARTS REQUIRED

10 - BACK PANEL x1

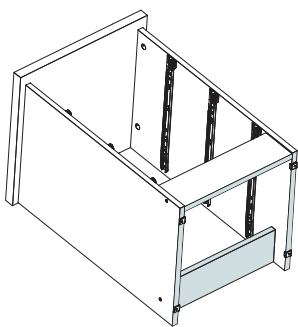

HARDWARE REQUIRED

F  14

TOOLS REQUIRED

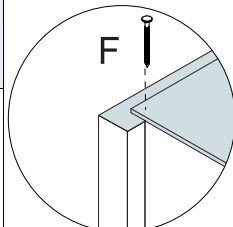
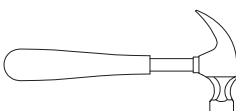

Detail 8

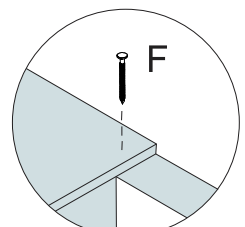
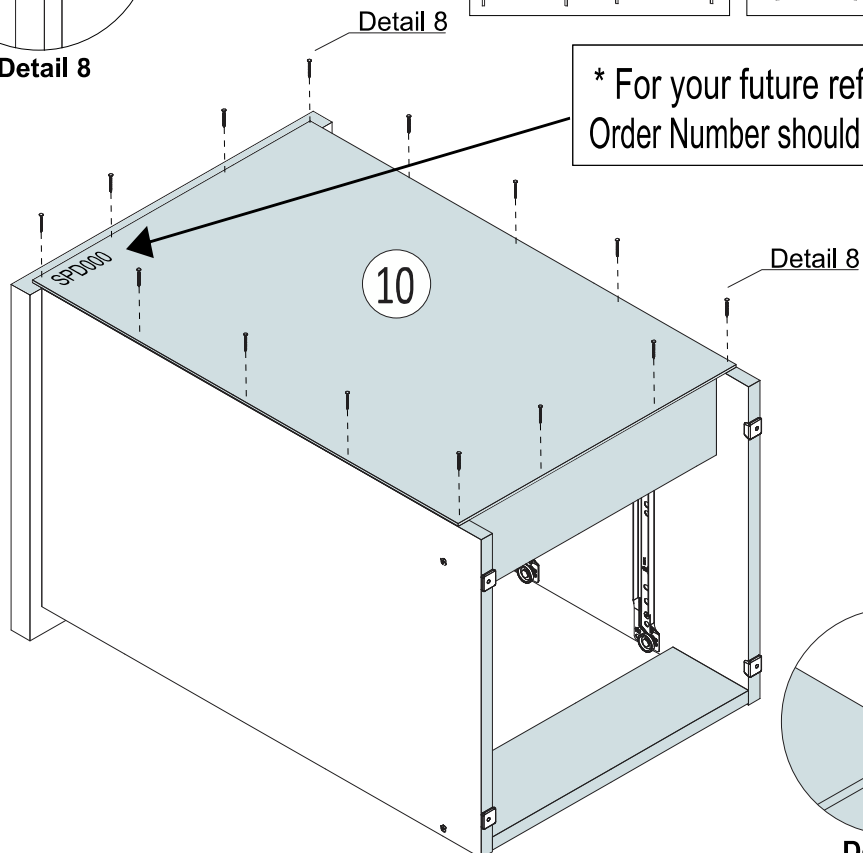
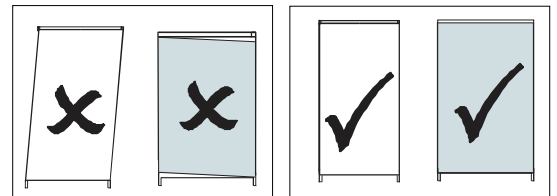

Detail 8

STEP 13

PARTS REQUIRED

6 - DRAWER SIDE x6

7 - DRAWER BACK PANEL x3

HARDWARE REQUIRED

D  06
Ø4 x 50mm

TOOLS REQUIRED

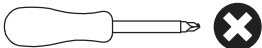

X3

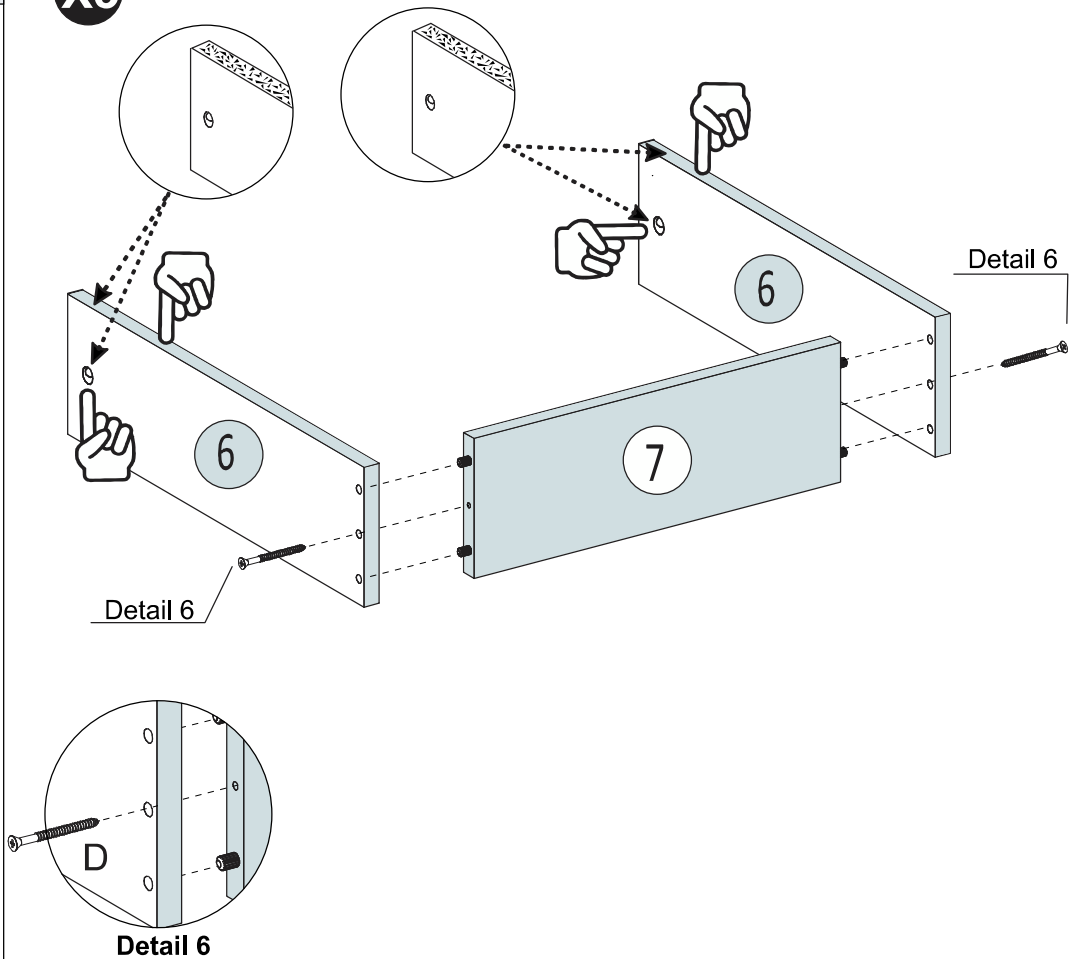

STEP 14

PARTS REQUIRED

5 - DRAWER FRONT x3

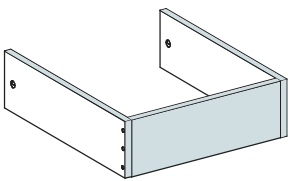

HARDWARE REQUIRED

H  06

K  01
GLUE

TOOLS REQUIRED

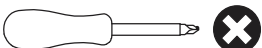

X3

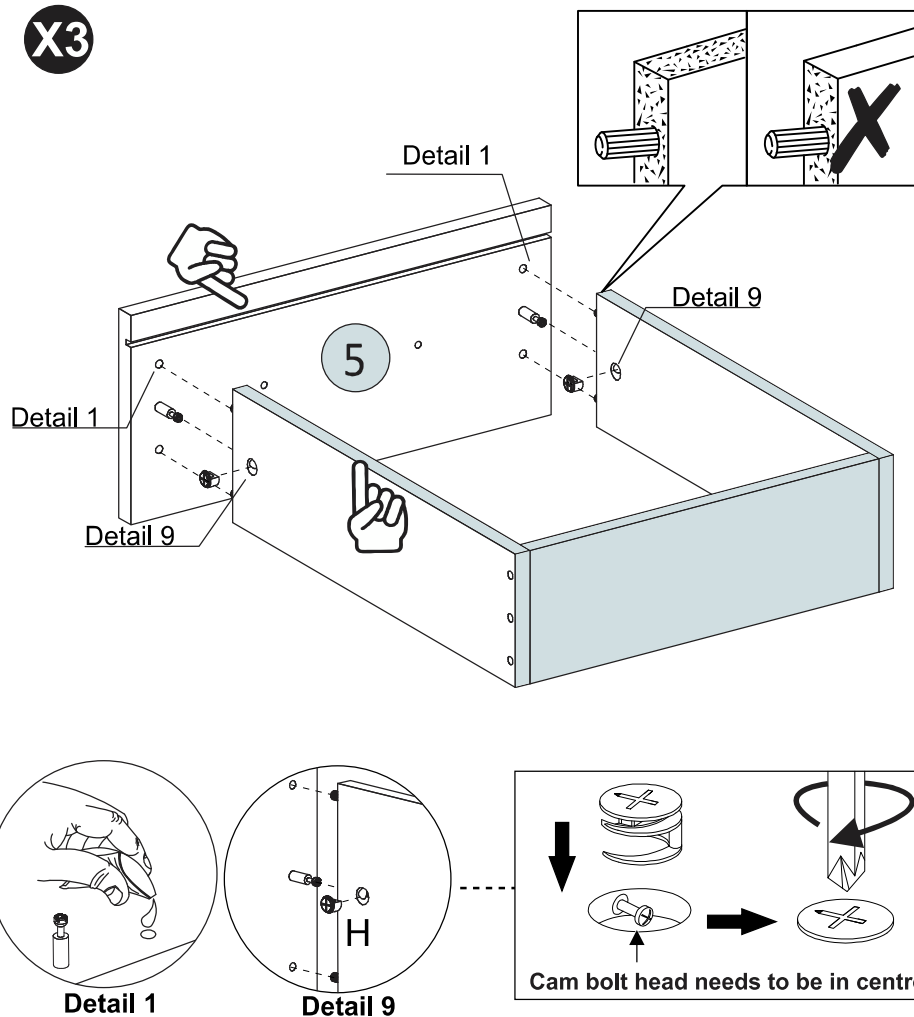

STEP 15

PARTS REQUIRED

8 - DRAWER BOTTOM x3

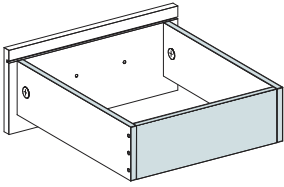

HARDWARE REQUIRED

F  12
10 x 10

TOOLS REQUIRED

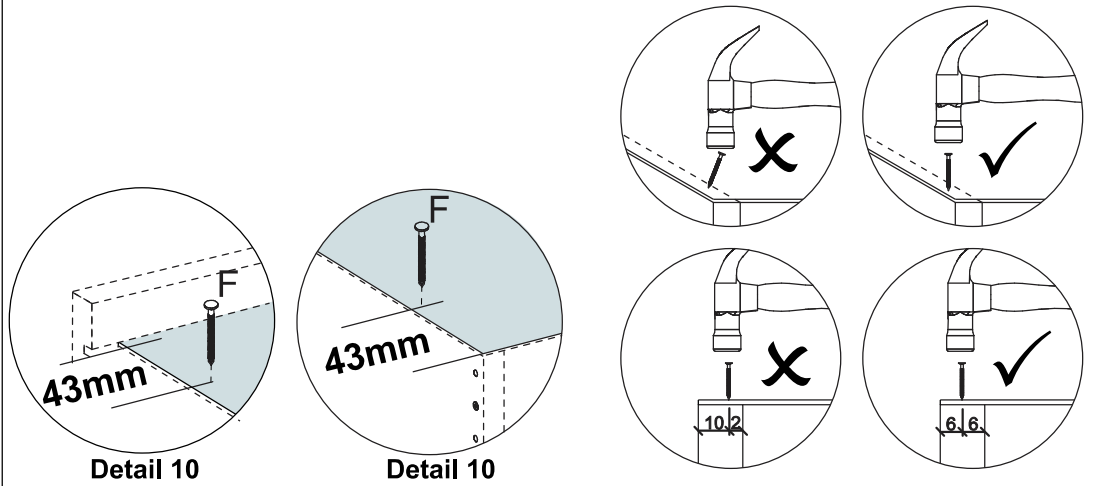
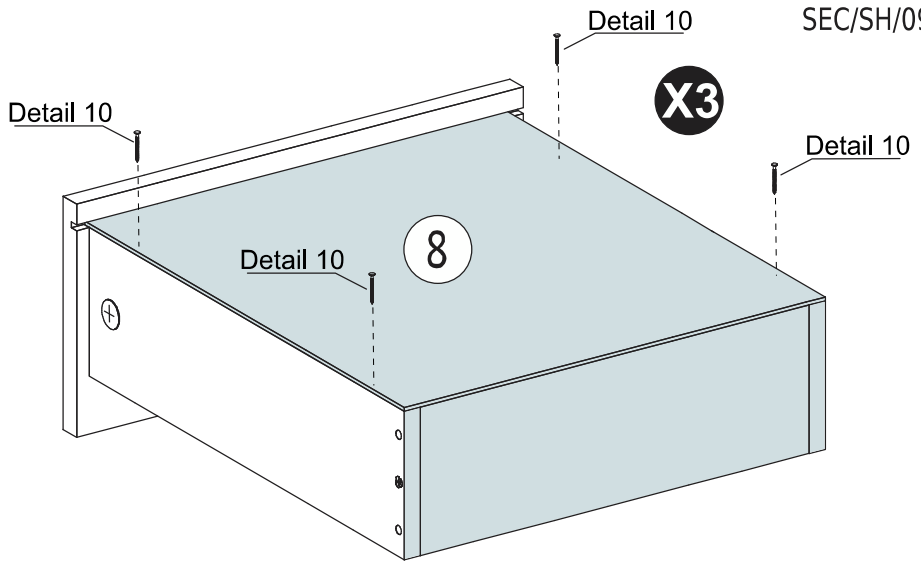
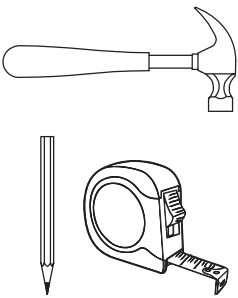

STEP 16

PARTS REQUIRED

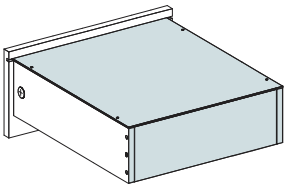

HARDWARE REQUIRED

F  12
10 x 10

TOOLS REQUIRED

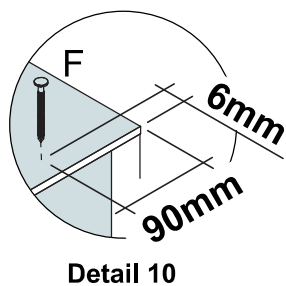
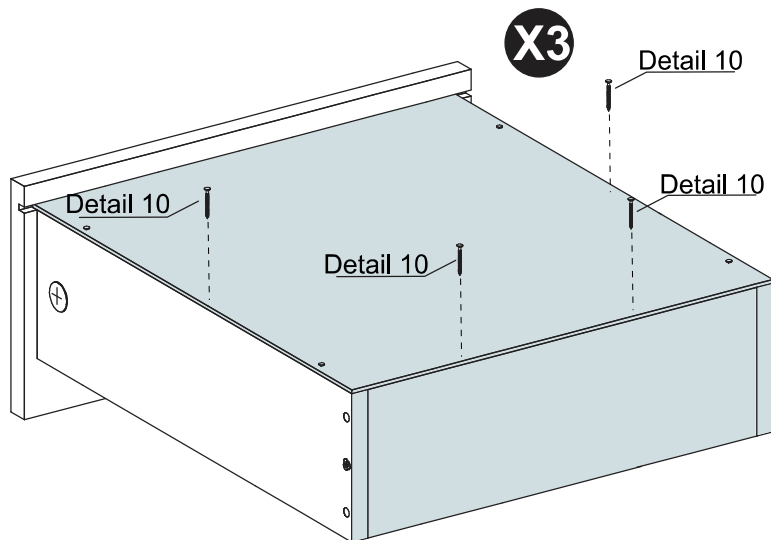
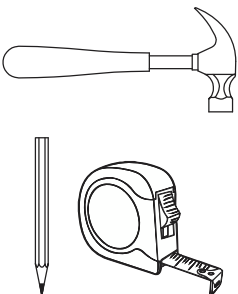

STEP 17

PARTS REQUIRED

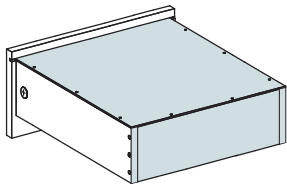

HARDWARE REQUIRED

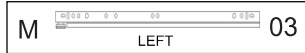
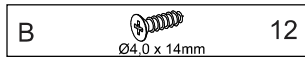

TOOLS REQUIRED

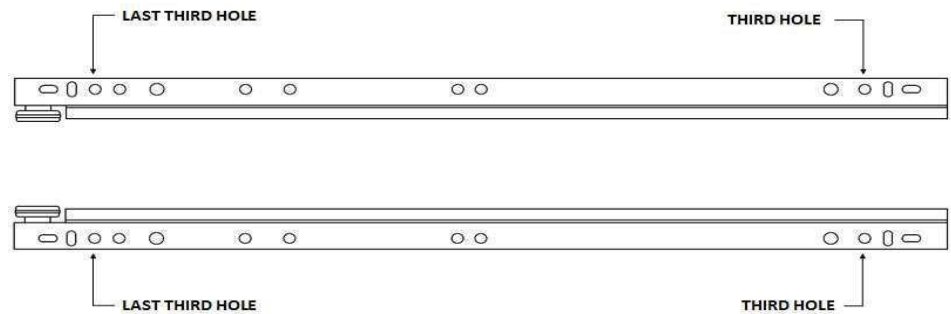
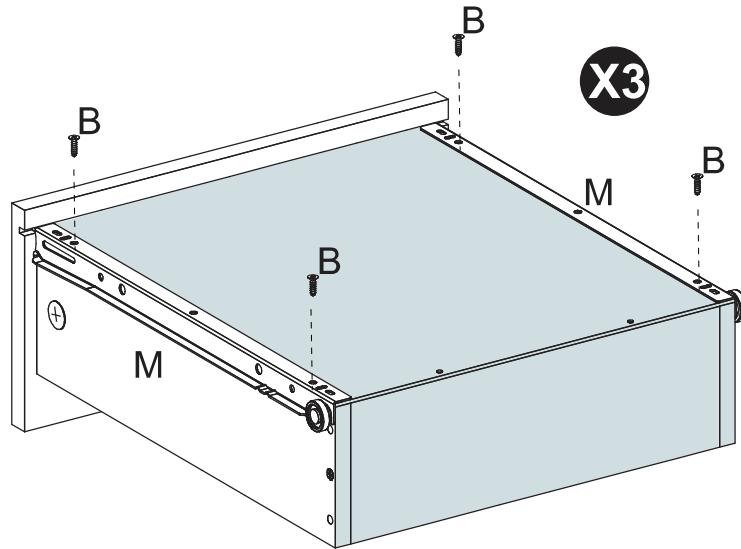
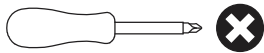

STEP 18

PARTS REQUIRED

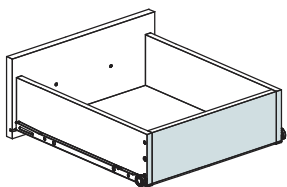

HARDWARE REQUIRED

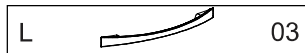
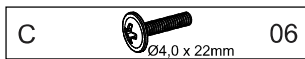

TOOLS REQUIRED

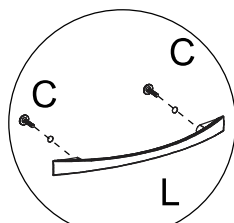
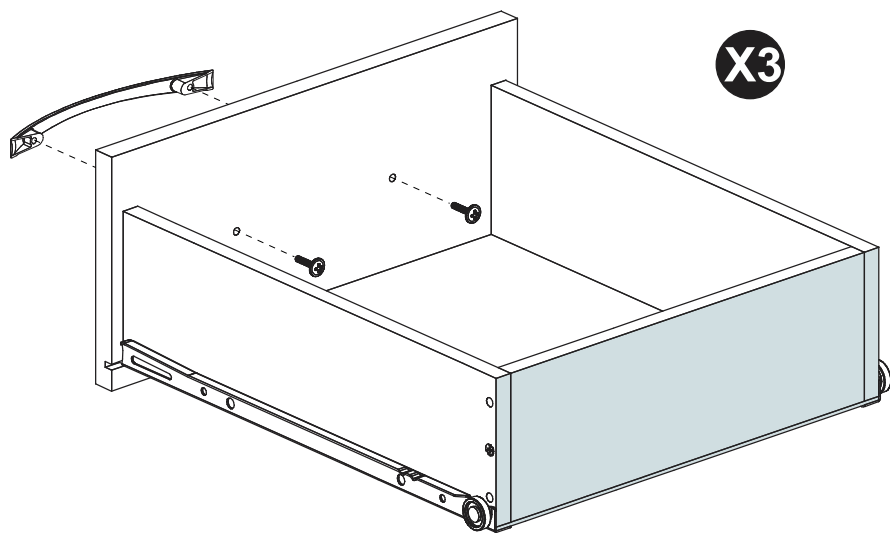
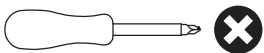

Detail 11

STEP 19

PARTS REQUIRED

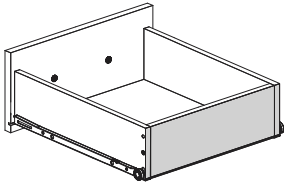

HARDWARE REQUIRED



TOOLS REQUIRED

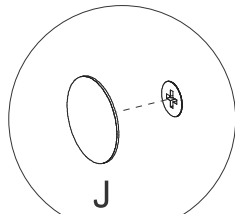
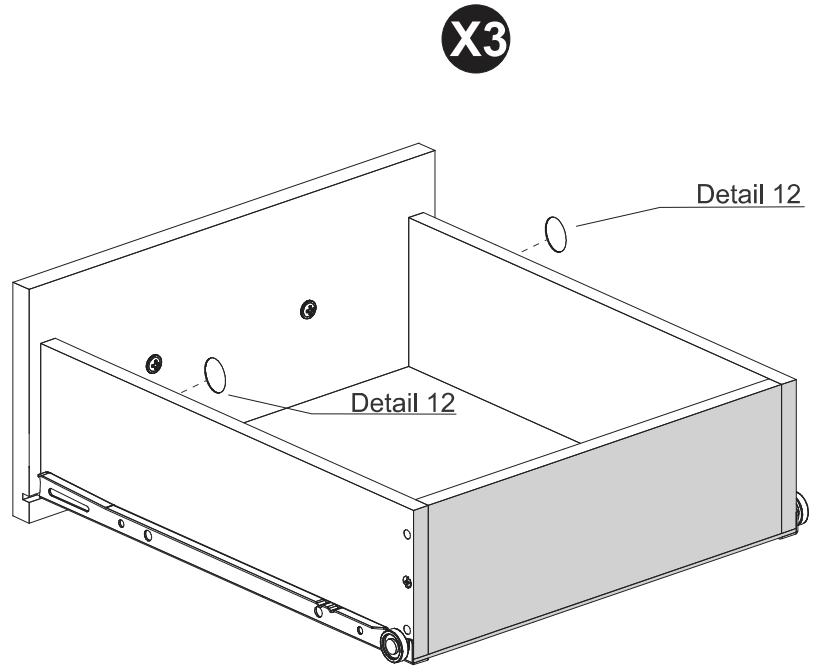

Detail 12

STEP 20

PARTS REQUIRED

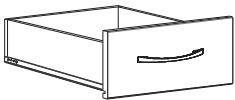

HARDWARE REQUIRED

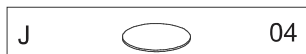

TOOLS REQUIRED

See the last page

TIP

If desired, after assembly use an alcohol cleaner to erase the number printed on the parts.

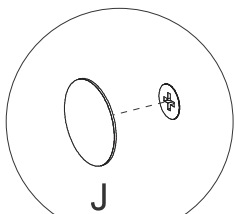
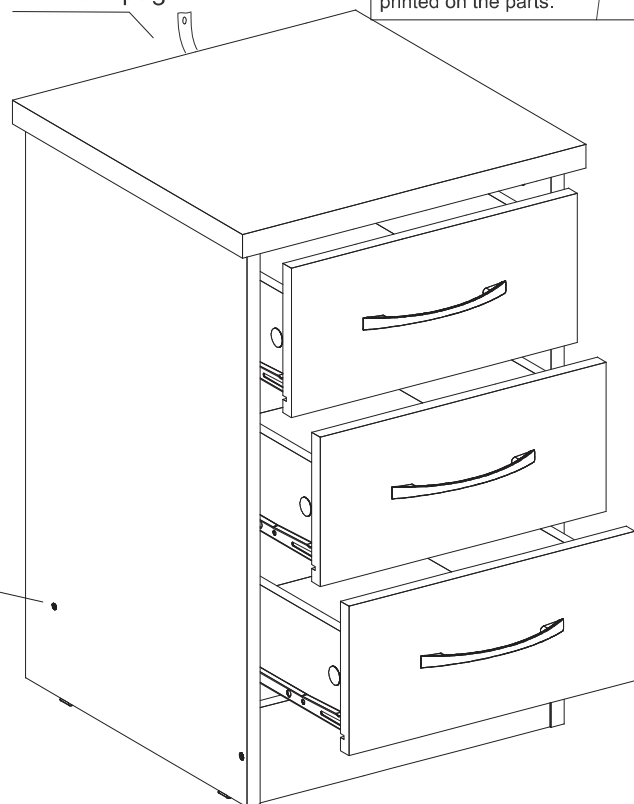
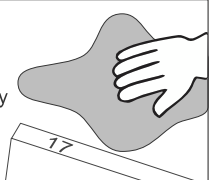

Detail 12

WARNING

Serious or fatal injuries can occur from furniture tipping over. To prevent the furniture from tipping over we recommend that it is permanently fixed to the wall.

Wall fixings are not supplied with this product as different wall materials require different types of fixing devices.

Please make sure you use fixings suitable for the walls in your home.

