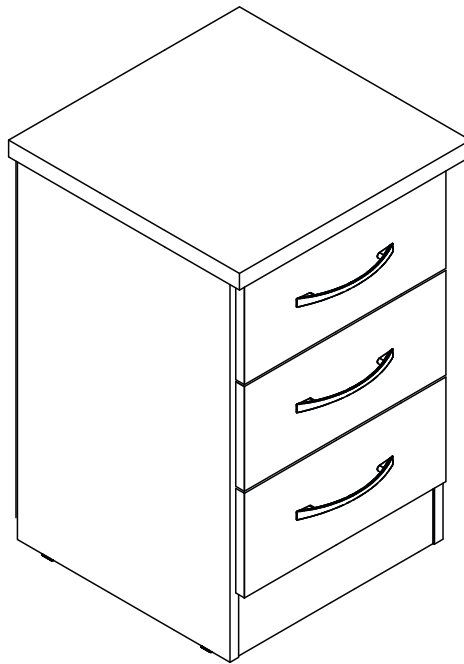

# NEVADA 3 DRAWER BEDSIDE ASSEMBLY INSTRUCTIONS

## IMPORTANT FOR DOMESTIC USE ONLY

PLEASE READ BEFORE YOU CONTINUE FURTHER

## CARE AND MAINTENANCE

After unpacking this product please keep the original packaging in case it needs to be returned for any reason.

- Please ensure all fittings and parts are present before commencing with assembly.
- Never drag or push products as this could cause damage to the joints making it inferior.
- We strongly recommend that you keep children away from your work area.
- We recommend that you lay a blanket or sheet on the floor to avoid damage to both your floor and the product.
- Assemble this product as close to its final position as possible.
- Do not place this product next to a radiator or in direct sunlight.
- Do not drag or push items across your high gloss furniture as this may cause the surface to scratch
- Wood is a natural product and may expand if subjected to damp and may shrink or crack if subjected to heat. Therefore it is recommended that room temperature is maintained, with no sudden temperature fluctuations.
- Make sure any spillage is wiped off immediately.
- Do not place hot or chilled items directly on to the surface, use a place mat or marking will occur.
- For general cleaning use a soft cotton or micro fibre cloth, and do not use detergents of any kind.
- From time to time it may be necessary to tighten fittings, regular inspections should be carried out.
- Do not place on a wet or damp floor as staining may occur to your floor.

TOOLS REQUIRED

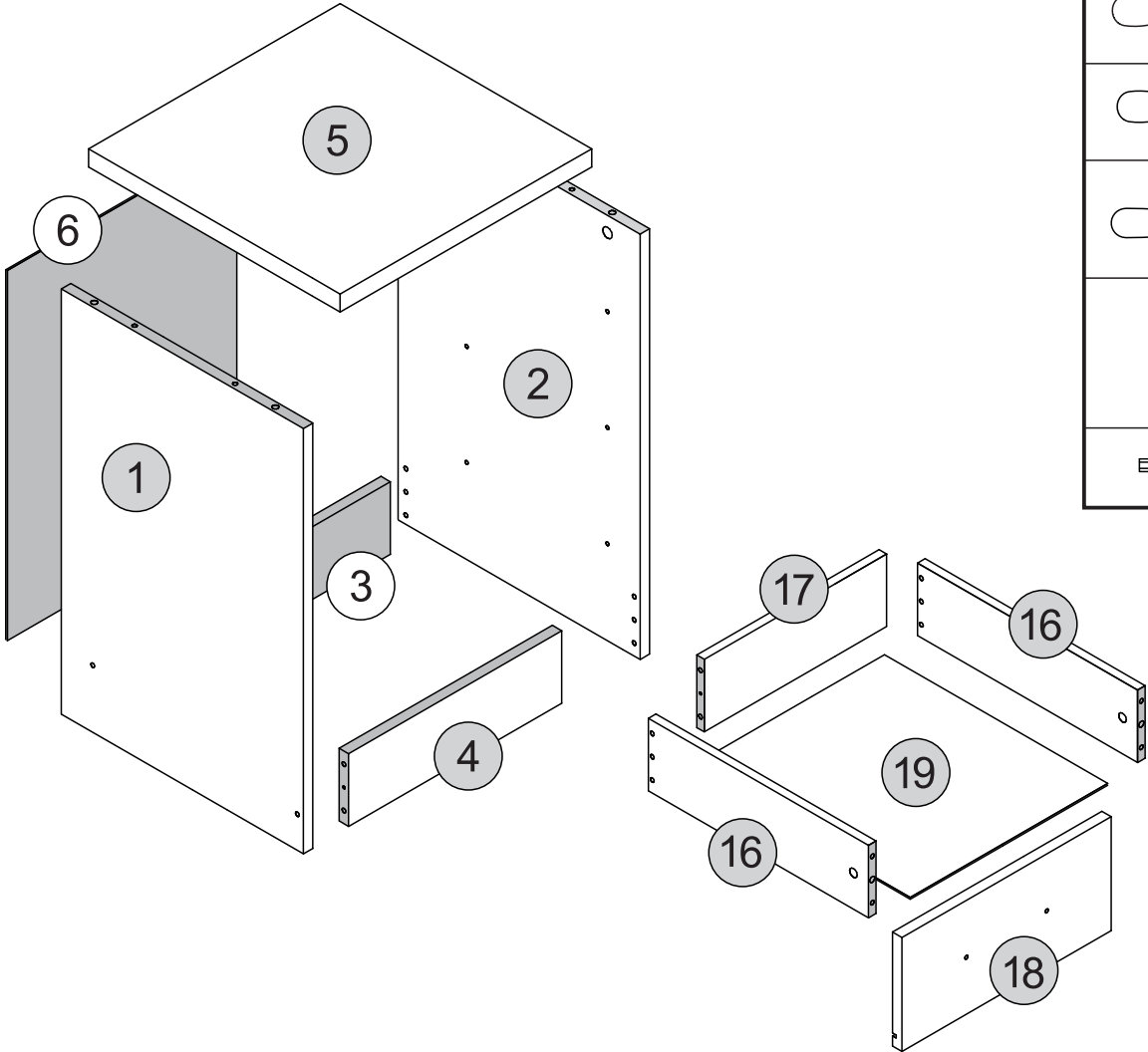
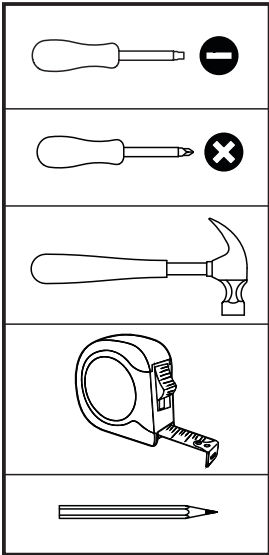





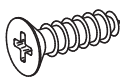
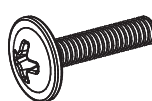
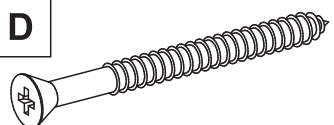
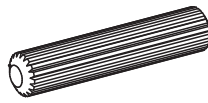
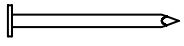
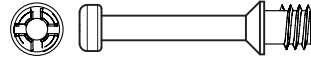

**PARTS LIST**

**Please Note:**  
The below parts have all been stamped with the part number to help identify them during assembly.

<b>Part Number</b>	<b>Part Description</b>	<b>Quantity</b>	<b>Carton</b>
1	Left Side Panel	1	1/1
2	Right Side Panel	1	1/1
3	Back Baseboard	1	1/1
4	Front Baseboard	1	1/1
5	Top Panel	1	1/1
6	Back Panel	1	1/1
16	Drawer Side	6	1/1
17	Drawer Back Panel	3	1/1
18	Drawer Front	3	1/1
19	Drawer Bottom	3	1/1



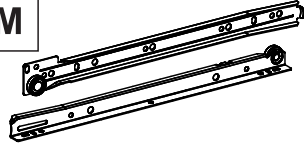
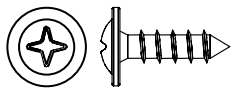

# FITTINGS LIST

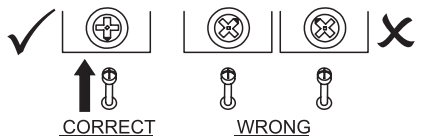

<p><b>A</b></p>  <p>Flat Head Screw Ø6,0 x 8mm (12x)</p> <p>2/+</p>	<p><b>B</b></p>  <p>Flat Head Screw Ø4,0 x 14mm (18x)</p> <p>2/+</p>	<p><b>C</b></p>  <p>Flan Head Screw Ø4,0 x 20mm (6x)</p> <p>1/+</p>	<p><b>D</b></p>  <p>Flat Head Screw Ø4,0 x 45mm (10x)</p> <p>1/+</p>
<p><b>E</b></p>  <p>Dowel Ø6,0 x 30mm (36x)</p> <p>2/+</p>	<p><b>F</b></p>  <p>Nail 10 x 10 (40x)</p> <p>5/+</p>	<p><b>G</b></p>  <p>Cam Bolt (10x)</p> <p>1/+</p>	<p><b>H</b></p>  <p>Cam Nut Ø12mm (10x)</p> <p>1/+</p>
<p><b>I</b></p>  <p>Plastic Foot (4x)</p> <p>1/+</p>	<p><b>J</b></p>  <p>Hole Plugs (16x)</p> <p>2/+</p>	<p><b>K</b></p>  <p>GLUE</p> <p>Glue (2x)</p>	<p><b>L</b></p>  <p>Handle (3x)</p>
<p><b>M</b></p>  <p>Drawer Runners (3x)</p>	<p><b>N</b></p>  <p>Flan Head Screw Ø3,5 x 12mm (2x)</p> <p>1/+</p>		

## TIPS FOR FITTINGS CAM-LOCKS

WHEN FITTING CAM NUT. ENSURE STARTING POSITION IS CORRECT BEFORE YOU INSERT CONNECTING CAM BOLT TURN CLOCKWISE UNTIL SECURE



CORRECT                      WRONG

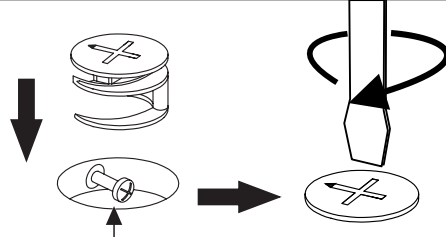

Cam bolt head needs to be in centre

### CAMBOLT

Tighten until shoulder in flush with panel. Do not overtighten or undertighten (see example beside)

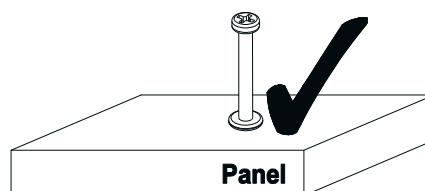
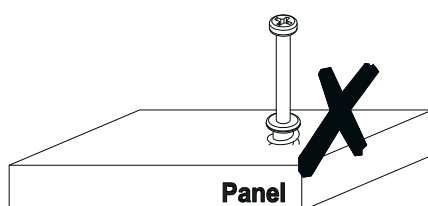
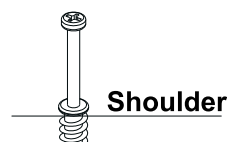



# STEP 1

## PARTS REQUIRED

1 - LEFT SIDE PANEL x1

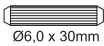
## HARDWARE REQUIRED

E  02  
Ø6,0 x 30mm

F  02  
10 x 10

I  02

K  01  
GLUE

## TOOLS REQUIRED

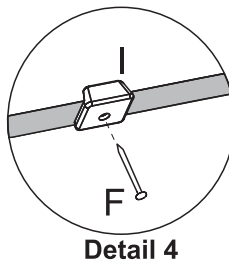
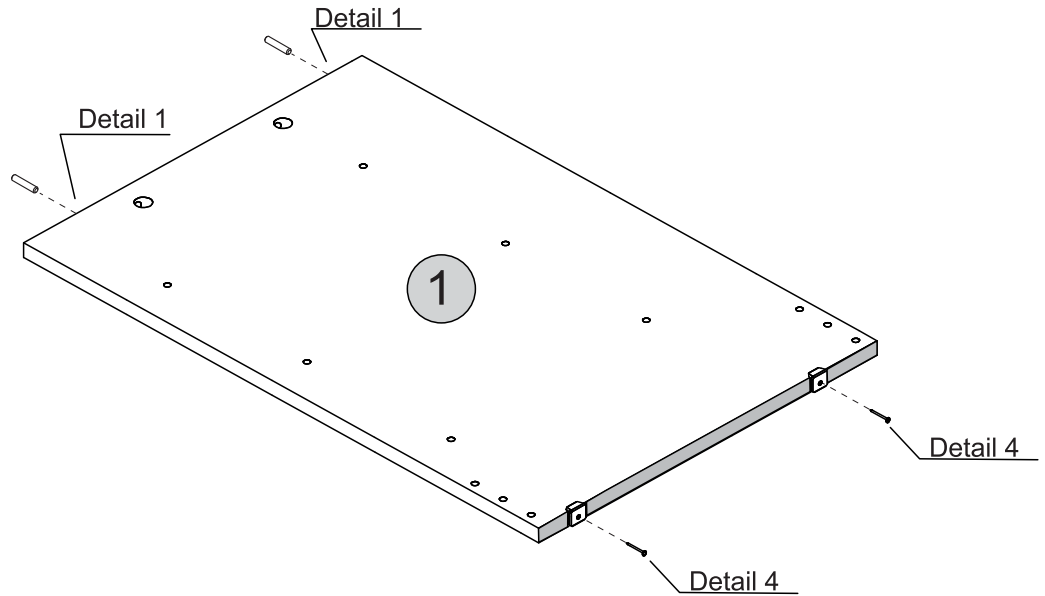
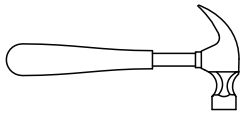



# STEP 2

## PARTS REQUIRED

2 - RIGHT SIDE PANEL x1

## HARDWARE REQUIRED

E  02  
Ø6,0 x 30mm

F  02  
10 x 10

I  02

K  01  
GLUE

## TOOLS REQUIRED

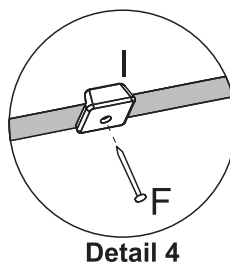
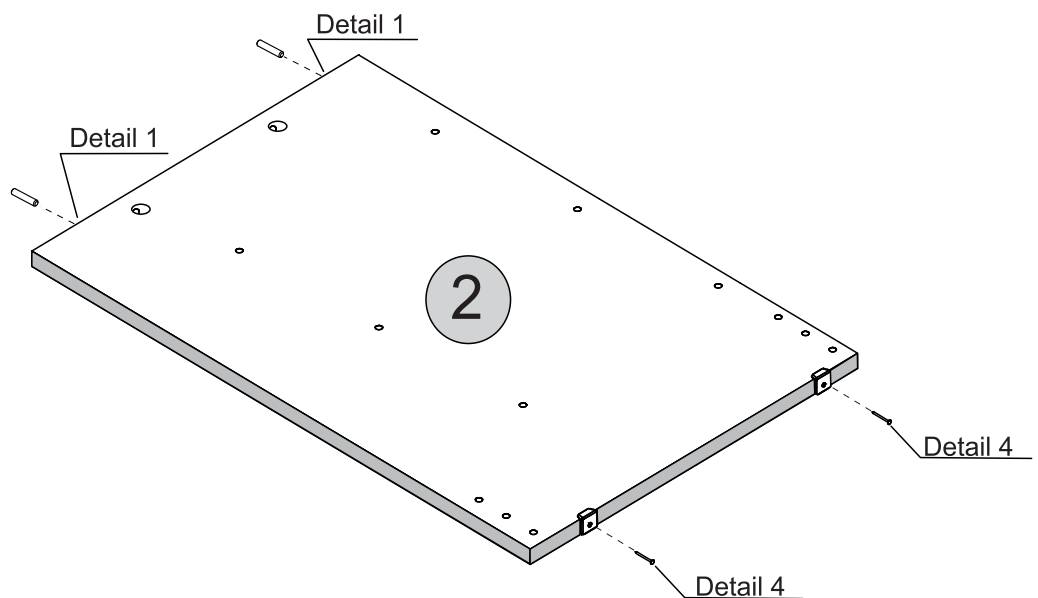
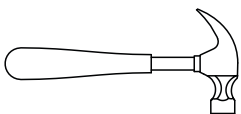



# STEP 3

## PARTS REQUIRED

2 - RIGHT SIDE PANEL x1

## HARDWARE REQUIRED

- A  06  
Ø6,0 x 8mm
- M  03

## TOOLS REQUIRED

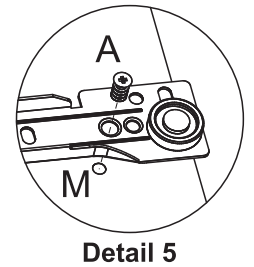
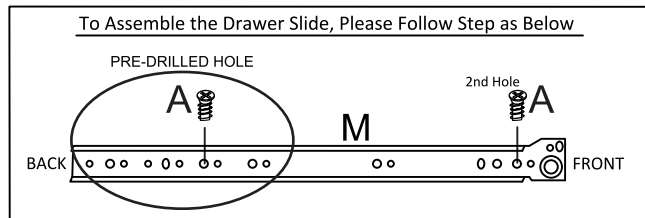
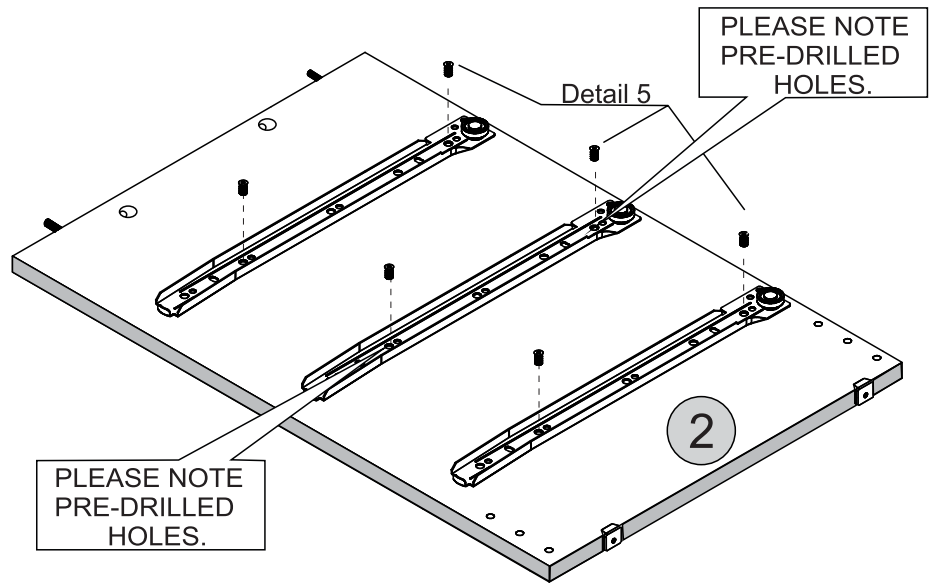
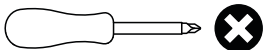



# STEP 4

## PARTS REQUIRED

1 - LEFT SIDE PANEL x1

## HARDWARE REQUIRED

- A  06  
Ø6,0 x 8mm
- M  03

## TOOLS REQUIRED

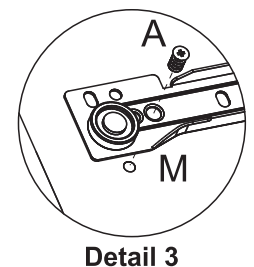
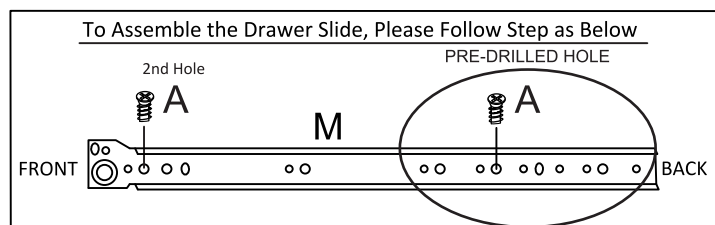
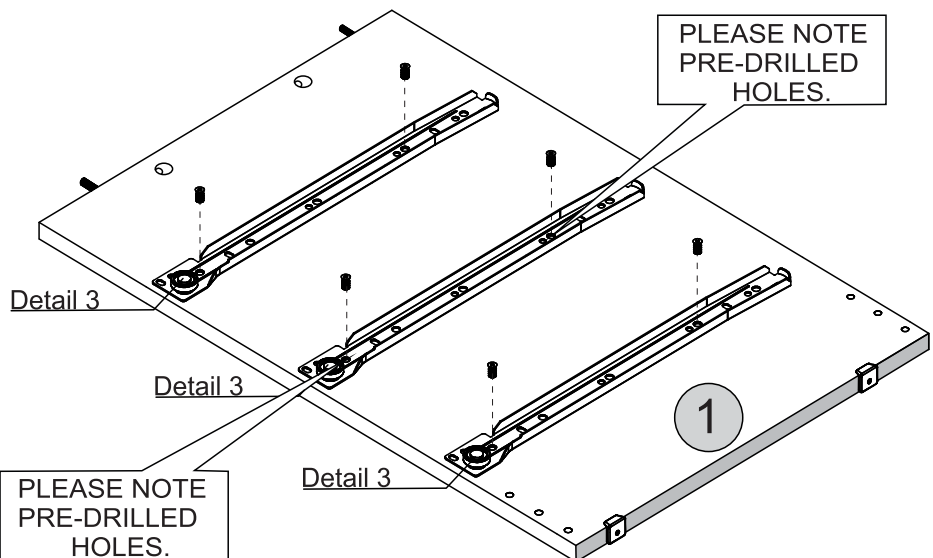
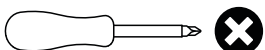

# STEP 5

## PARTS REQUIRED

3 - BACK BASEBOARD x1

4 - FRONT BASEBOARD x1

## HARDWARE REQUIRED

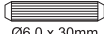
E  08  
Ø6.0 x 30mm

K  01

## TOOLS REQUIRED

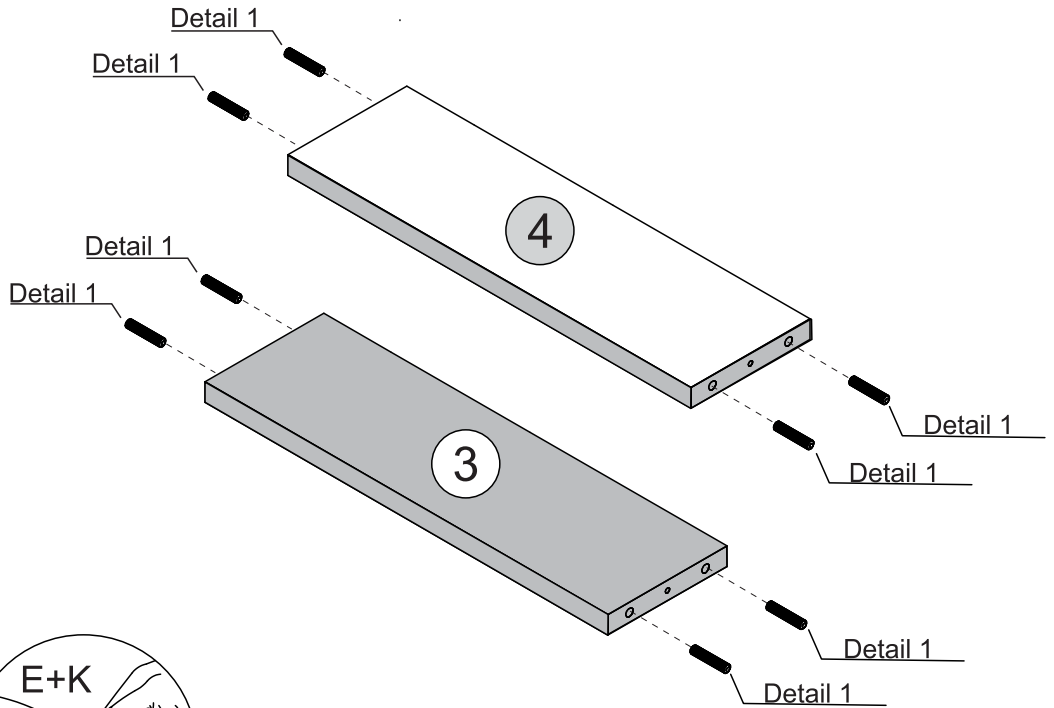

Detail 1

# STEP 6

## PARTS REQUIRED

2 - RIGHT SIDE PANEL x1

3 - BACK BASEBOARD x1

4 - FRONT BASEBOARD x1

## HARDWARE REQUIRED

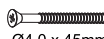
D  02  
Ø4.0 x 45mm

K  01

## TOOLS REQUIRED

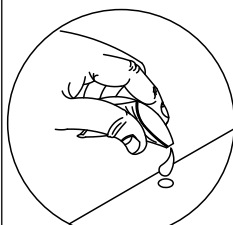
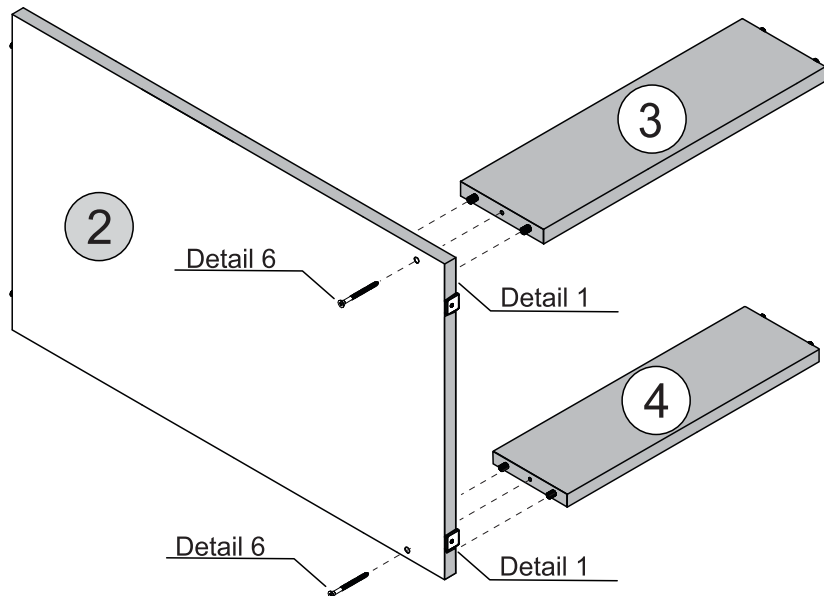
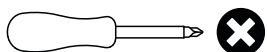

Detail 1

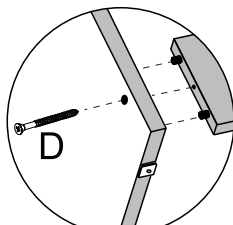

Detail 6

# STEP 7

## PARTS REQUIRED

1 - LEFT SIDE PANEL x1

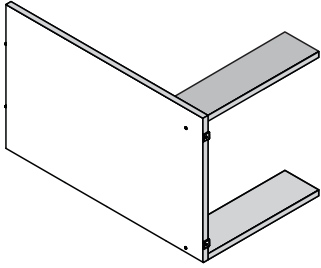

## HARDWARE REQUIRED

D  Ø4,0 x 45mm 02

K  GLUE 01

## TOOLS REQUIRED

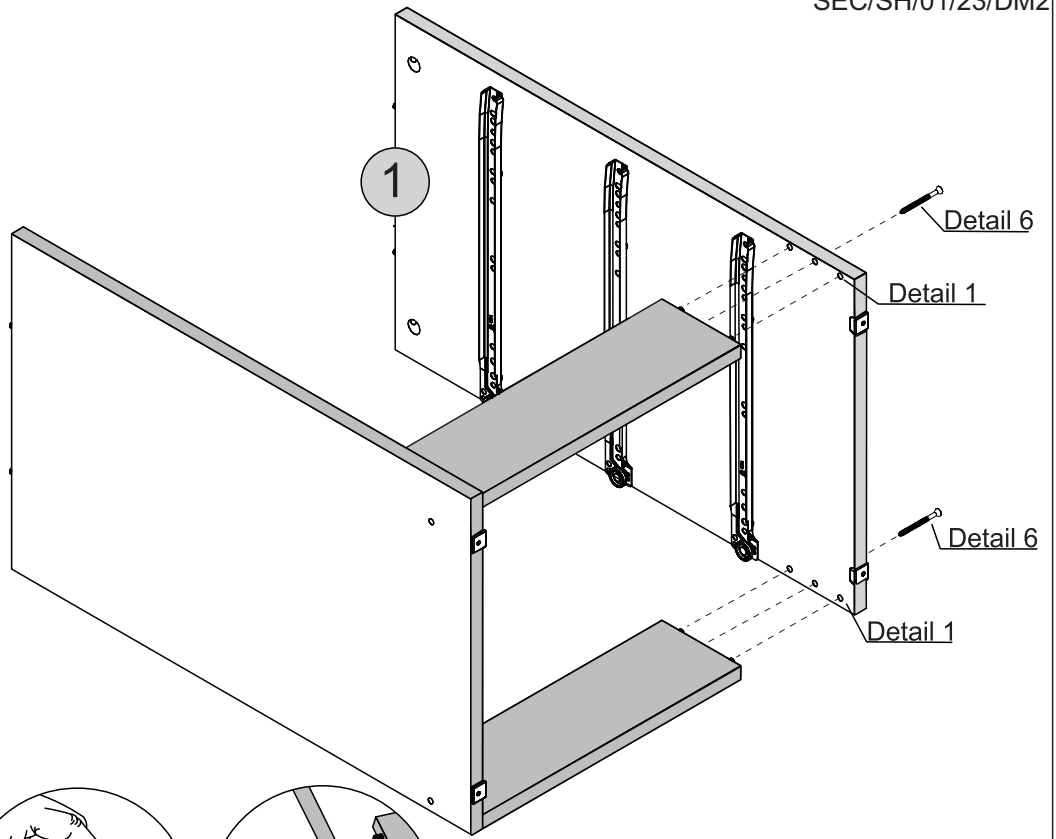
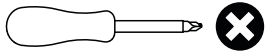

Detail 1

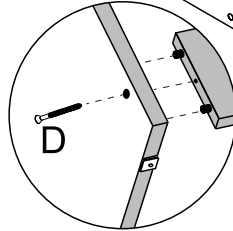

Detail 6

# STEP 8

## PARTS REQUIRED

5 - TOP PANEL x1

## HARDWARE REQUIRED

G  04

## TOOLS REQUIRED

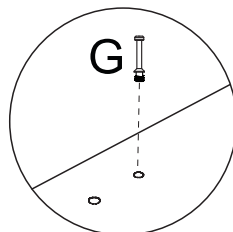
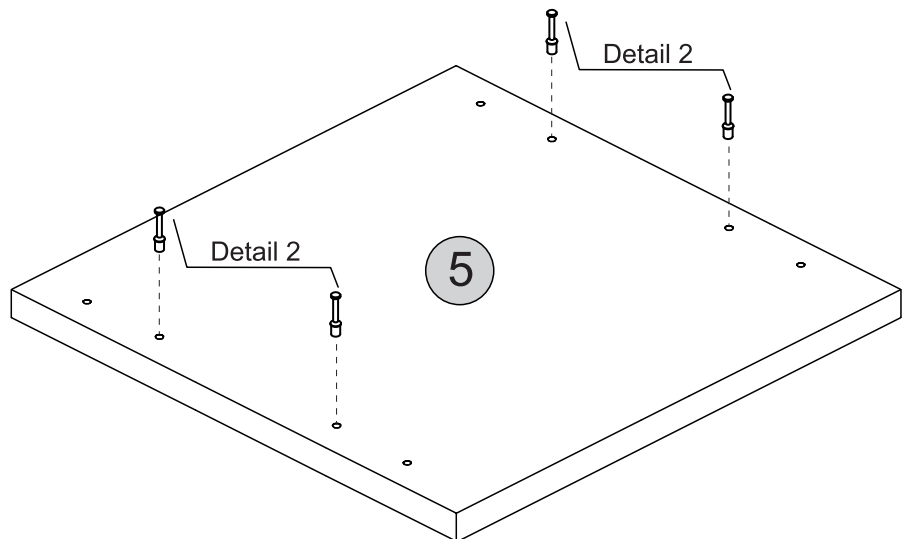
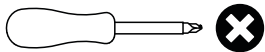

Detail 2

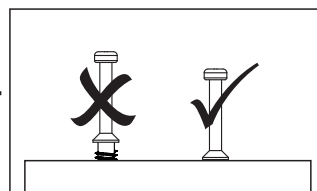

# STEP 9

## PARTS REQUIRED

5 - TOP PANEL x1

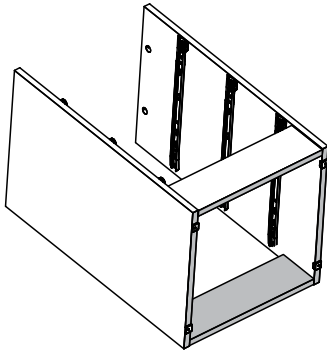

## HARDWARE REQUIRED

H  04

K  01

## TOOLS REQUIRED

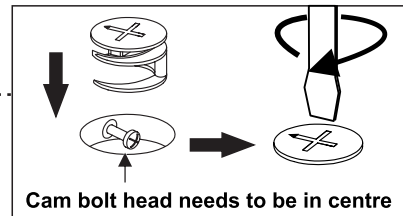
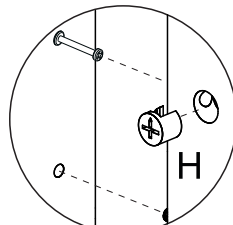
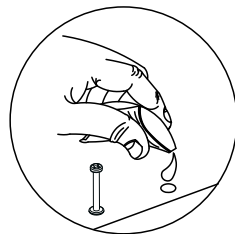
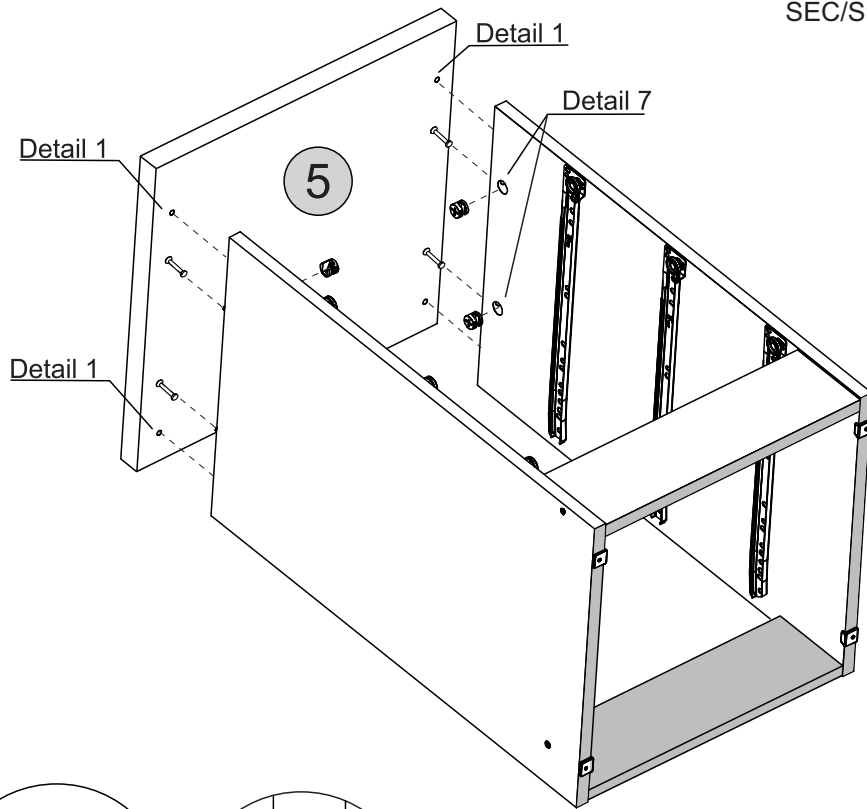
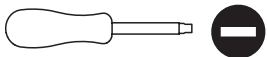

# STEP 10

## PARTS REQUIRED

6 - BACK PANEL x1

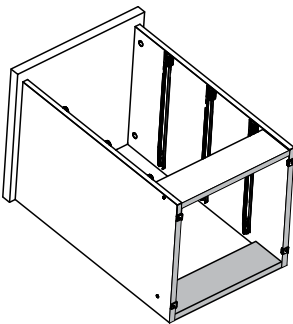

## HARDWARE REQUIRED

F  12  
10 x 10

N  02  
Ø3,5 x 12mm

## TOOLS REQUIRED

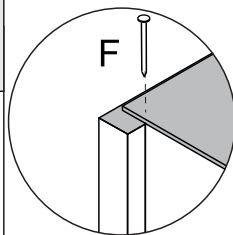
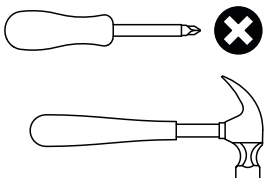

Detail 8

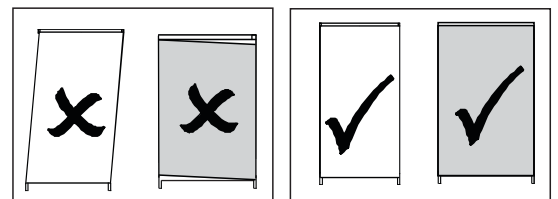

\* For your future reference  
Order Number should be here

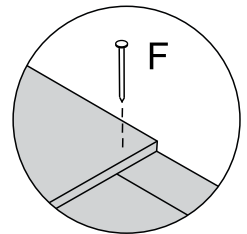
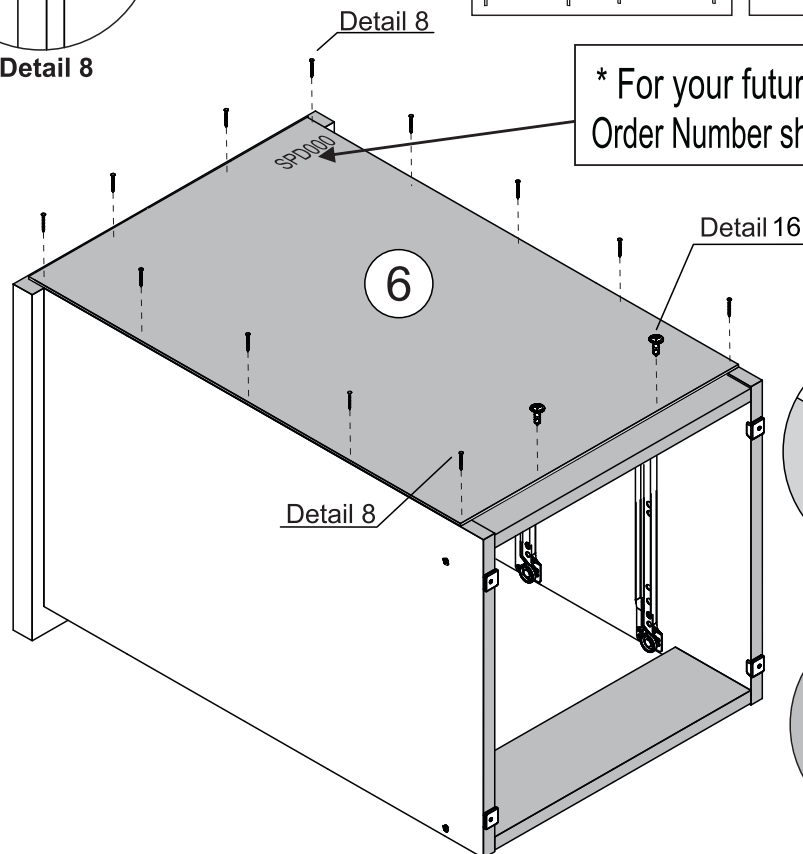

Detail 8

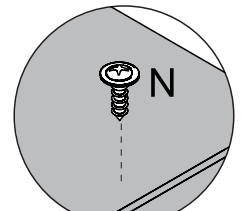

Detail 16



# STEP 11

## PARTS REQUIRED

16 - DRAWER SIDE x6

17 - DRAWER BACK PANEL x3

18 - DRAWER FRONT x3

## HARDWARE REQUIRED

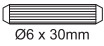
E  24  
Ø6 x 30mm

G  06

K  01

## TOOLS REQUIRED

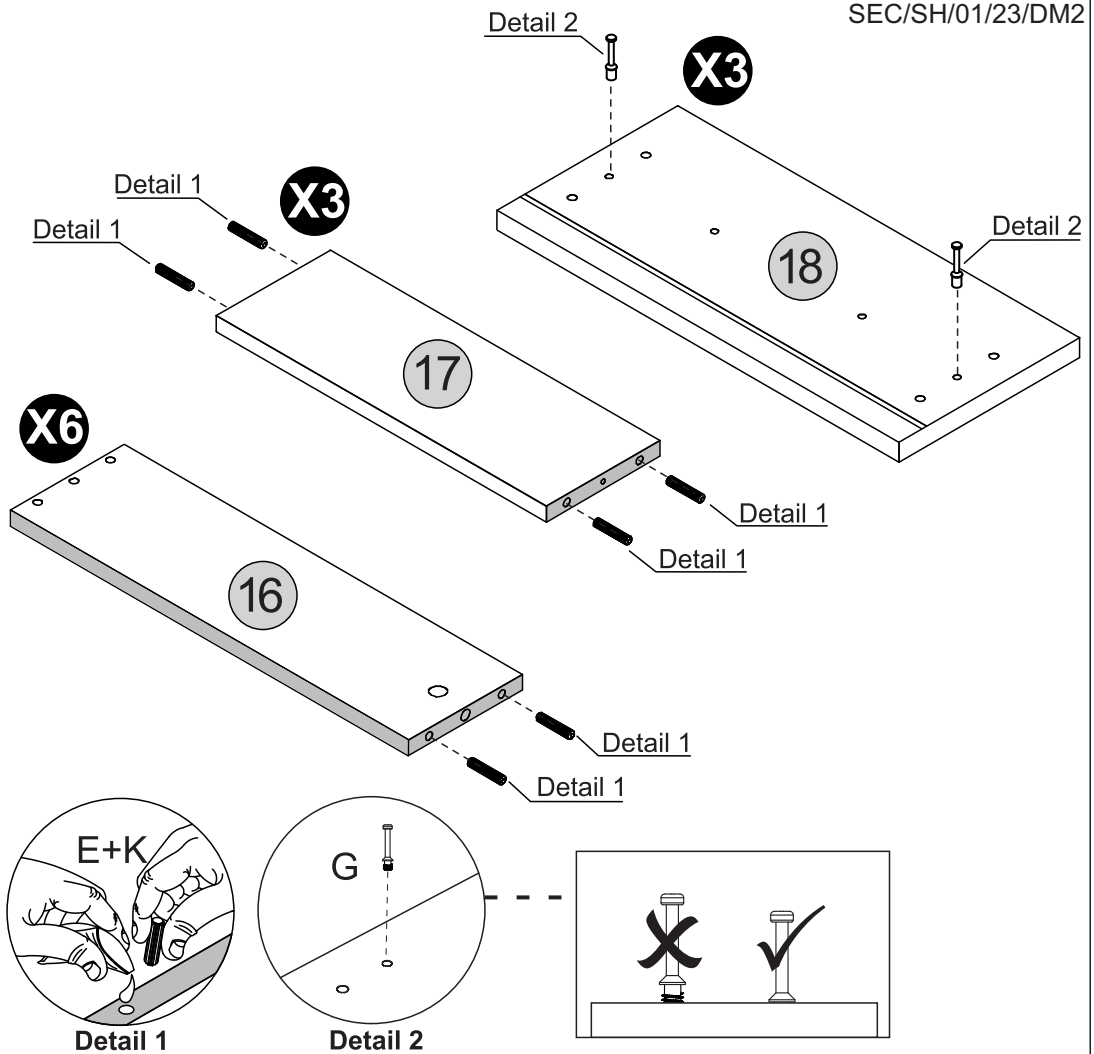
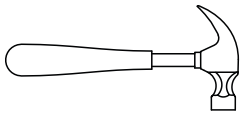
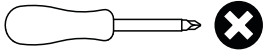

# STEP 12

## PARTS REQUIRED

16 - DRAWER SIDE x6

17 - DRAWER BACK PANEL x3

## HARDWARE REQUIRED

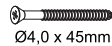
D  06  
Ø4,0 x 45mm

## TOOLS REQUIRED

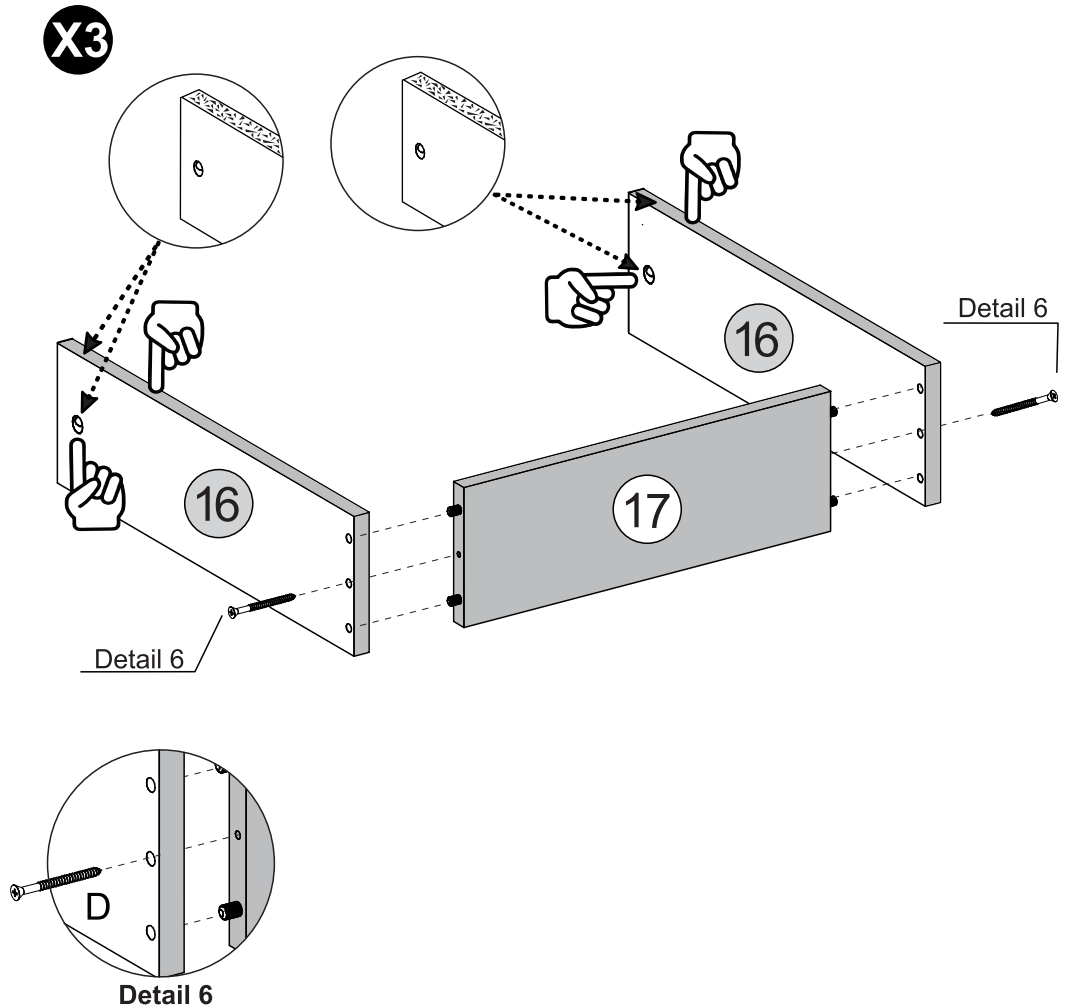
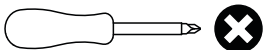

# STEP 13

**PARTS REQUIRED**

18 - DRAWER FRONT x3

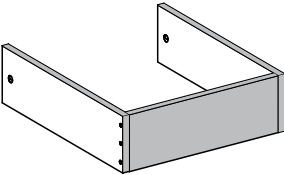

**HARDWARE REQUIRED**

K  01

**TOOLS REQUIRED**

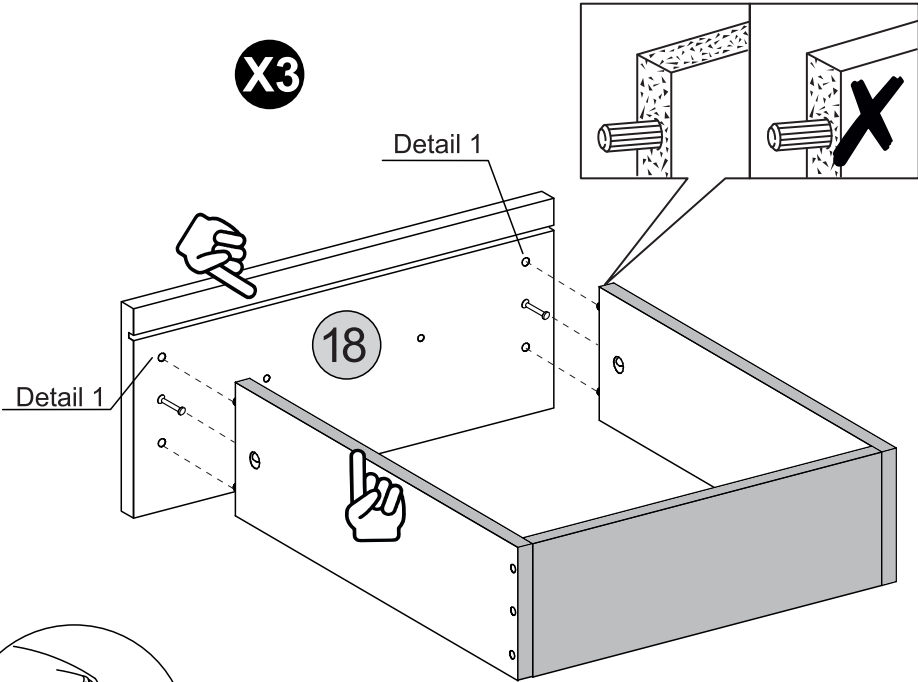
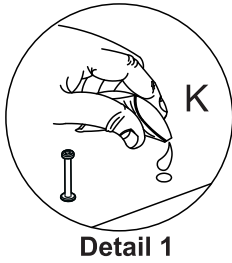

# STEP 14

**PARTS REQUIRED**

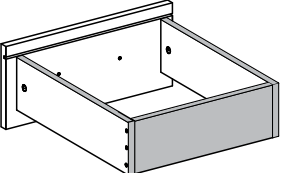

**HARDWARE REQUIRED**

H  06

J  12

**TOOLS REQUIRED**

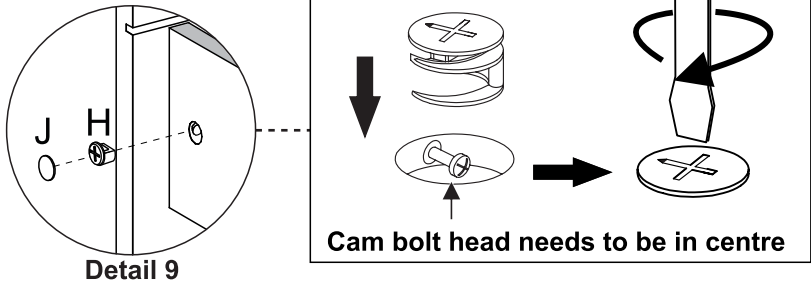
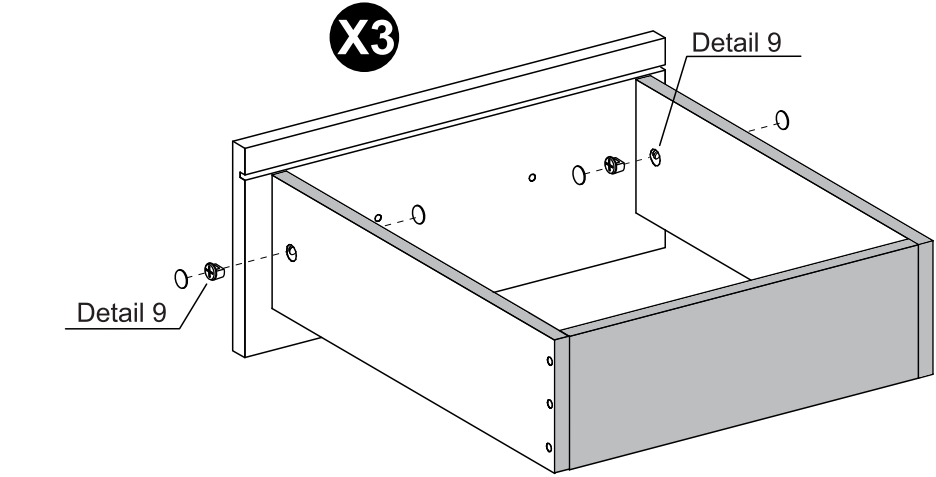
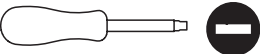

# STEP 15

## PARTS REQUIRED

19 - DRAWER BOTTOM x3

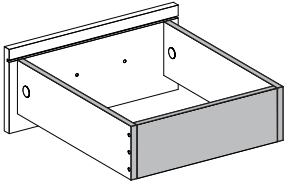

## HARDWARE REQUIRED

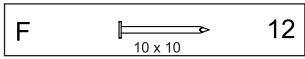

## TOOLS REQUIRED

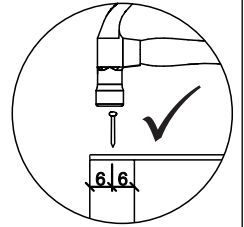
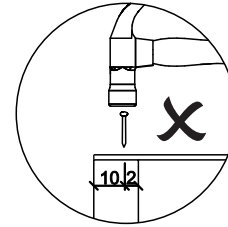
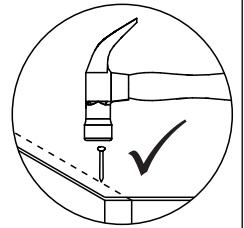
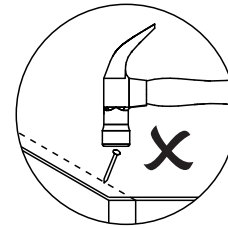
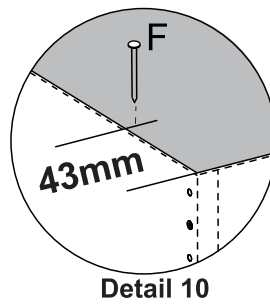
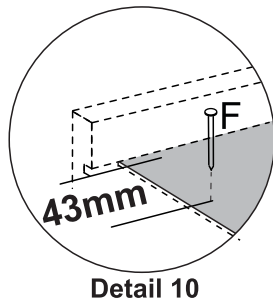
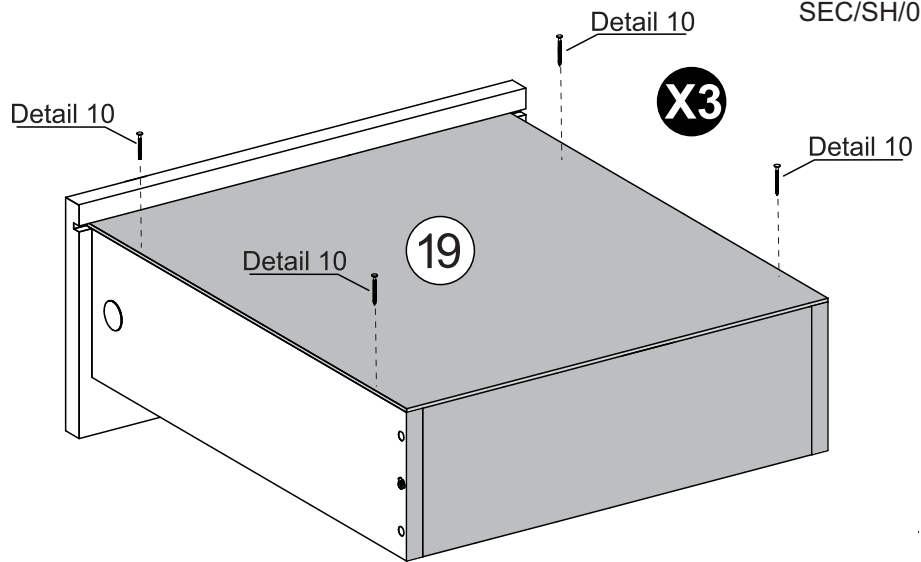
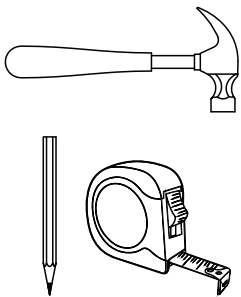

# STEP 16

## PARTS REQUIRED

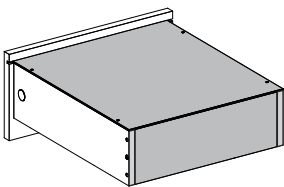

## HARDWARE REQUIRED

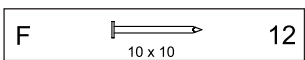

## TOOLS REQUIRED

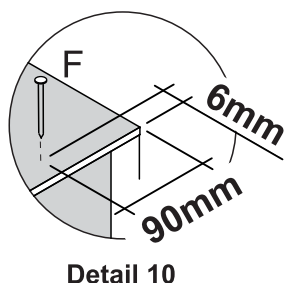
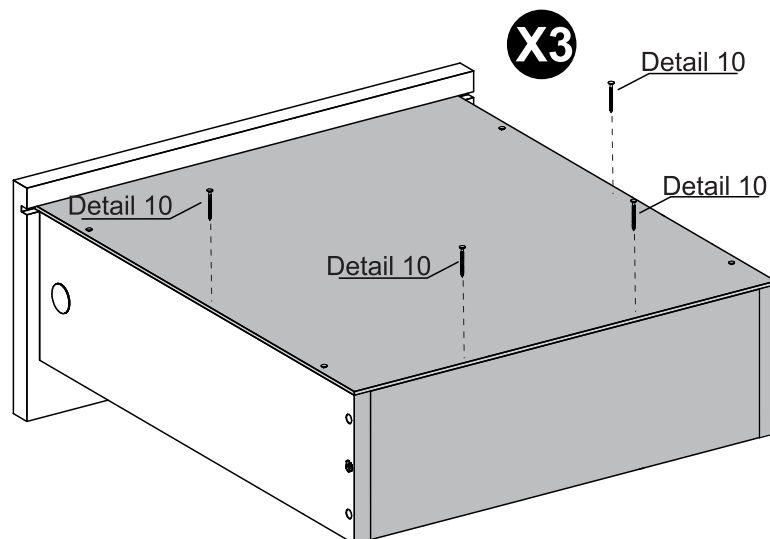
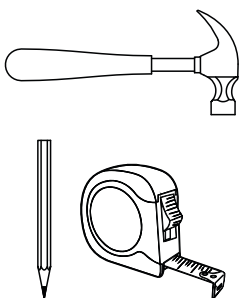

# STEP 17

**PARTS REQUIRED**

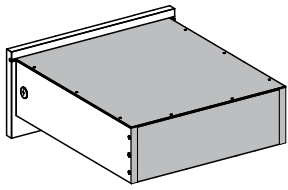

**HARDWARE REQUIRED**

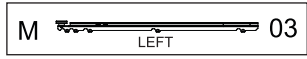
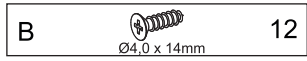

**TOOLS REQUIRED**

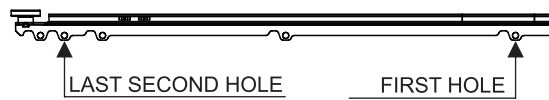
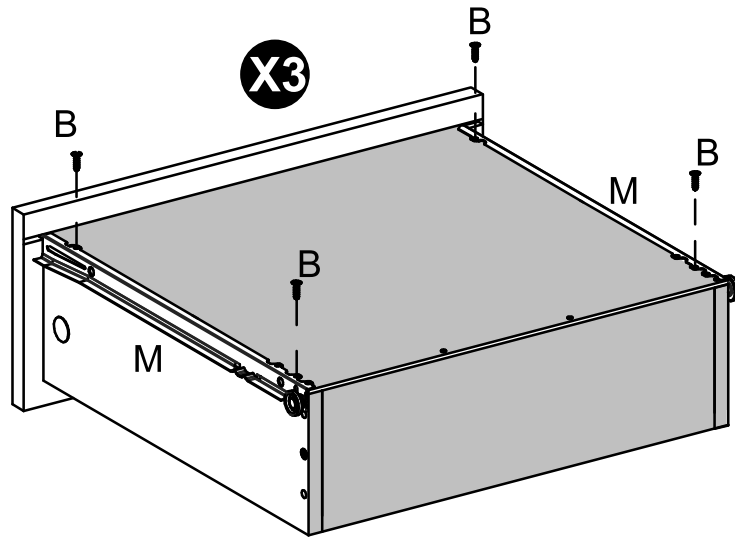
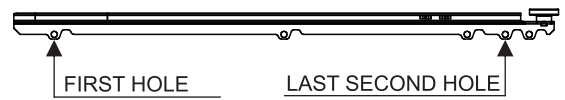
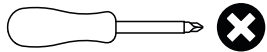

# STEP 18

**PARTS REQUIRED**

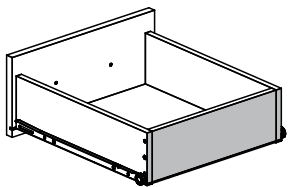

**HARDWARE REQUIRED**

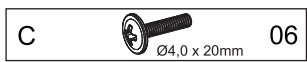

**TOOLS REQUIRED**

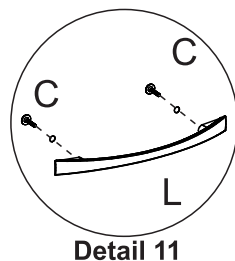
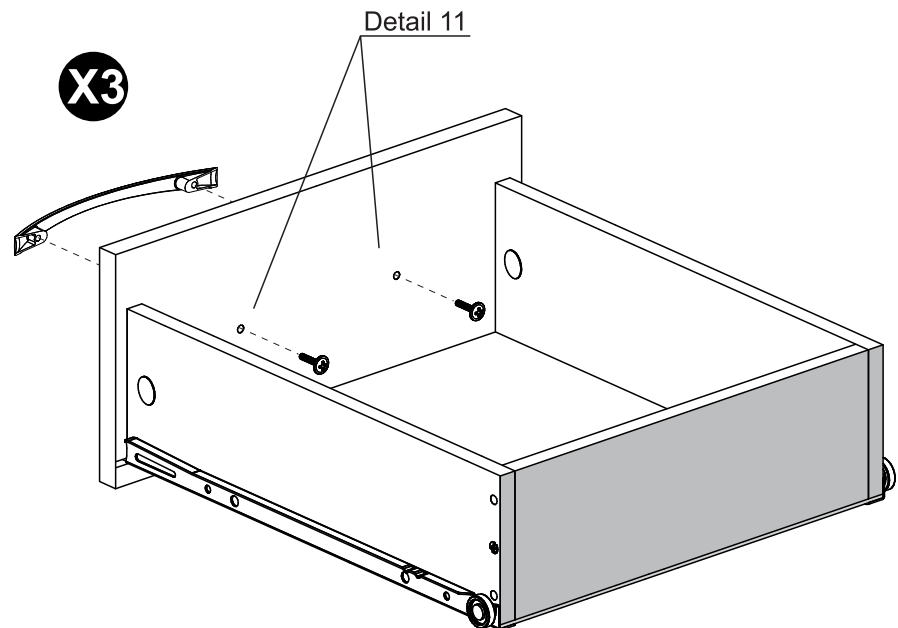
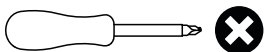

# STEP 19

### PARTS REQUIRED

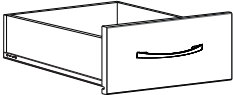
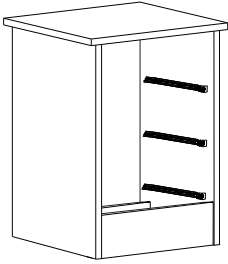

### HARDWARE REQUIRED



### TOOLS REQUIRED

**TIP**  
If desired, after assembly use an alcohol cleaner to erase the number printed on the parts.

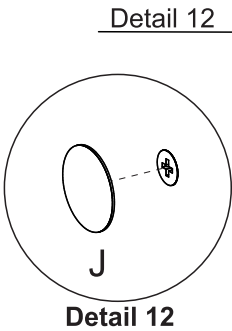
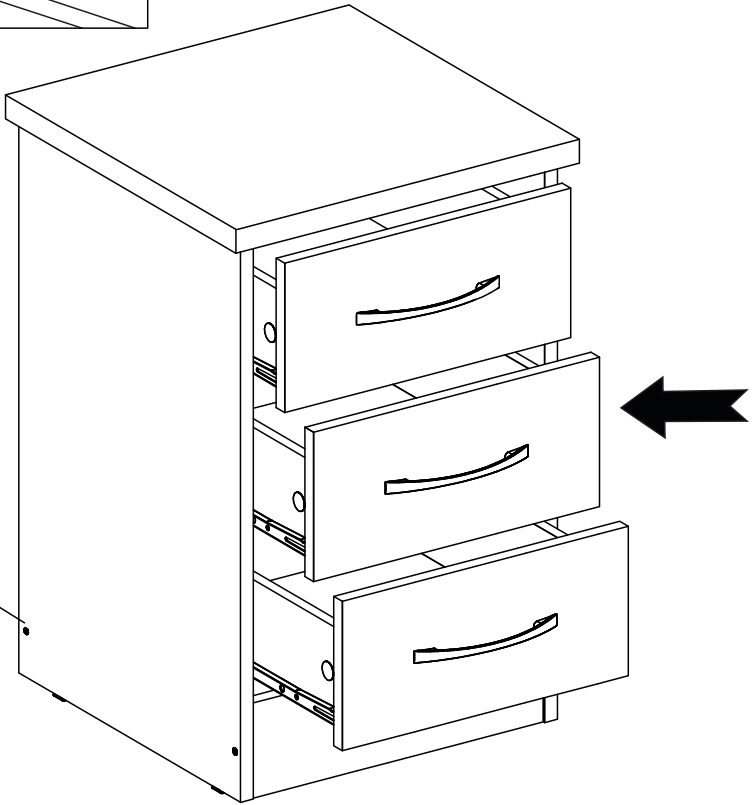

# STEP 20

### PARTS REQUIRED

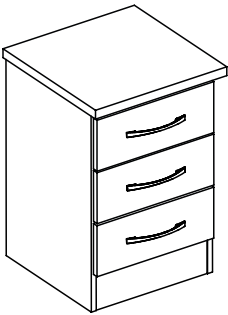

### HARDWARE REQUIRED

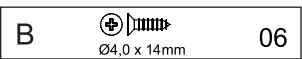

### TOOLS REQUIRED

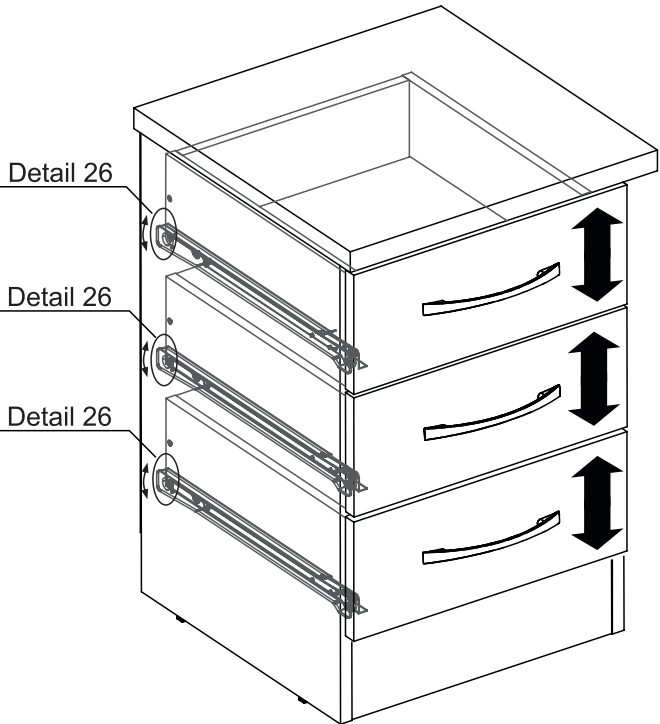

### Drawer Adjustment

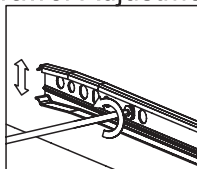

### Drawer Lock

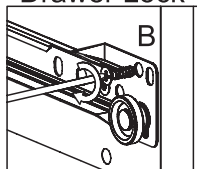

Detail 26