

NEVADA VANITY DRESSING TABLE SET ASSEMBLY INSTRUCTIONS WHITE GLOSS

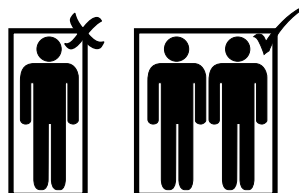

* You should assemble this product
with two people

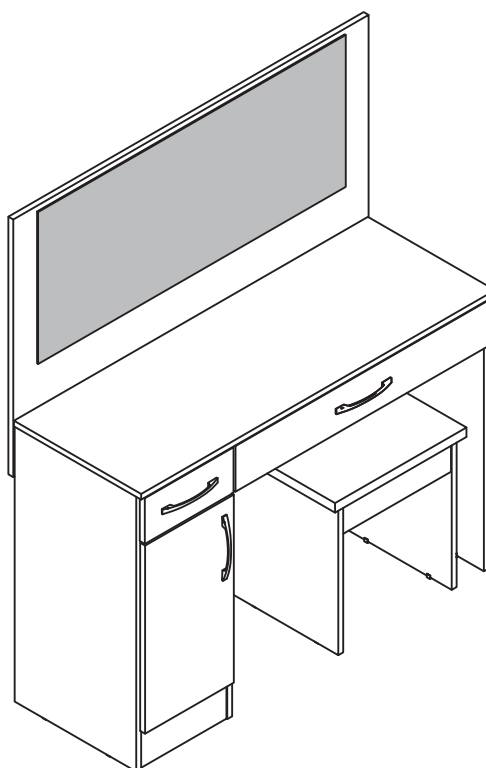

IMPORTANT FOR DOMESTIC USE ONLY

PLEASE READ BEFORE YOU CONTINUE FURTHER

CARE AND MAINTENANCE

- After unpacking this product please keep the original packaging in case it needs to be returned for any reason.
- Please ensure all fittings and parts are present before commencing with assembly.
 - Never drag or push products as this could cause damage to the joints making it inferior.
 - We strongly recommend that you keep children away from your work area.
 - We recommend that you lay a blanket or sheet on the floor to avoid damage to both your floor and the product.
 - Assemble this product as close to its final position as possible.
 - Do not place this product next to a radiator or in direct sunlight.
 - Do not drag or push items across your high gloss furniture as this may cause the surface to scratch
 - Wood is a natural product and may expand if subjected to damp and may shrink or crack if subjected to heat. Therefore it is recommended that room temperature is maintained, with no sudden temperature fluctuations.
 - Make sure any spillage is wiped off immediately.
 - Do not place hot or chilled items directly on to the surface, use a place mat or marking will occur.
 - For general cleaning use a soft cotton or micro fibre cloth, and do not use detergents of any kind.
 - From time to time it may be necessary to tighten fittings, regular inspections should be carried out.
 - Do not place on a wet or damp floor as staining may occur to your floor.

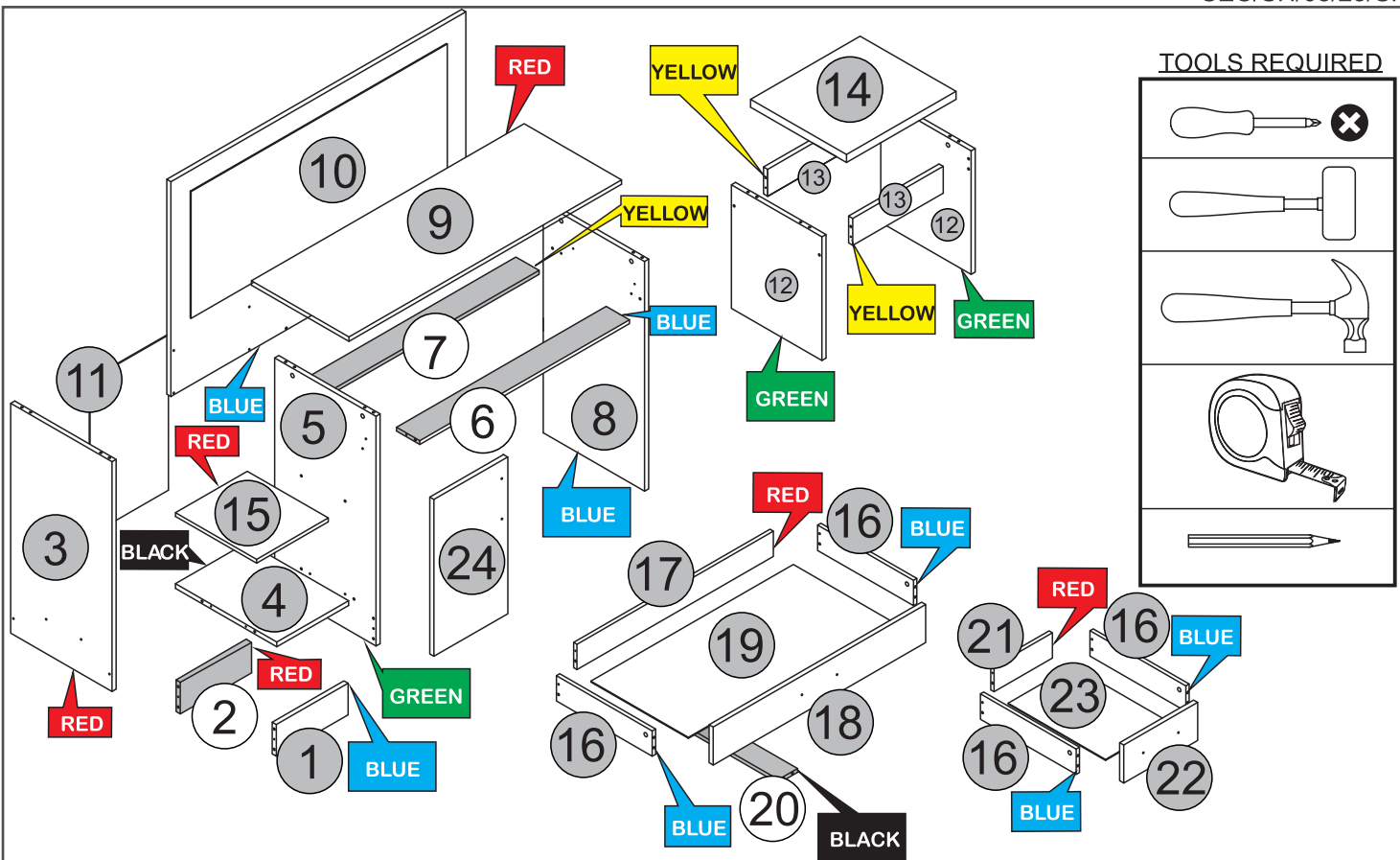









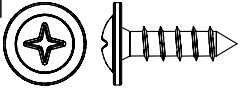
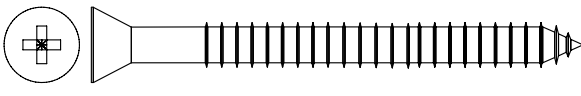
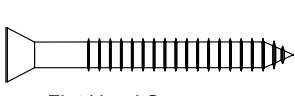

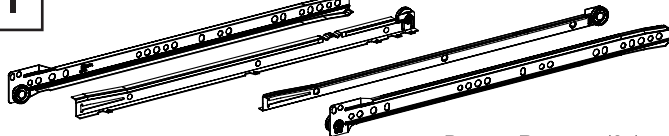
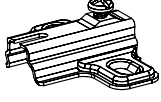
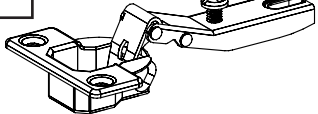
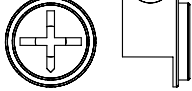
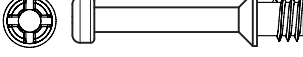

PARTS LIST

Please Note:
The below parts have all been stamped with the part number/color to help identify them during assembly.

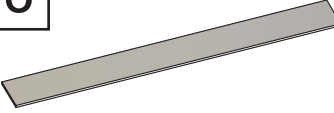
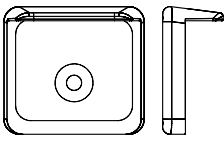
Part Number	Part Code	Part Description	Quantity	Carton
1	S100-107-020-SP1-01	Front Baseboard - BLUE	1	1/2
2	S100-107-020-SP1-02	Back Baseboard - RED	1	1/2
3	S100-107-020-SP1-03	Left Side Panel- RED	1	1/2
4	S100-107-020-SP1-04	Base Panel - BLACK	1	1/2
5	S100-107-020-SP1-05	Left Divison Panel - GREEN	1	1/2
6	S100-107-020-SP1-06	Front Crossbar - BLUE	1	1/2
7	S100-107-020-SP1-07	Back Crossbar - YELLOW	1	1/2
8	S100-107-020-SP1-08	Right Side Panel - BLUE	1	1/2
9	S100-107-020-SP1-09	Top Panel - RED	1	1/2
10	S100-107-020-SP1-10	Mirror Panel - BLUE	1	2/2
11	S100-107-020-SP1-11	Back Panel	1	1/2
12	S100-107-020-SP1-12	Stool Side Panel - GREEN	2	1/2
13	S100-107-020-SP1-13	Stool Crosspiece - YELLOW	2	1/2
14	S100-107-020-SP1-14	Stool Seat	1	1/2
15	S100-107-020-SP1-15	Shelf - RED	1	1/2
16	S100-107-020-SP1-16	Drawer Side - BLUE	4	1/2
17	S100-107-020-SP1-17	Large Drawer Back Panel - RED	1	1/2
18	S100-107-020-SP1-18	Large Drawer Front	1	1/2
19	S100-107-020-SP1-19	Large Drawer Bottom	1	1/2
20	S100-107-020-SP1-20	Drawer Bottom Support Bar - BLACK	1	1/2
21	S100-107-020-SP1-21	Small Drawer Back Panel - RED	1	1/2
22	S100-107-020-SP1-22	Small Drawer Front	1	1/2
23	S100-107-020-SP1-23	Small Drawer Bottom	1	1/2
24	S100-107-020-SP1-24	Door	1	1/2

FITTINGS LIST

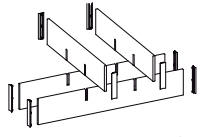
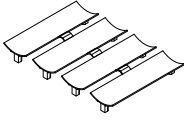
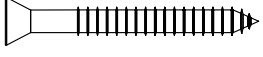
<p>A</p>  <p>Flan Head Screw Ø4,0 x 14mm (2x)</p> <p>1/+</p>	<p>B</p>  <p>Flat Head Screw Ø4,0 x 50mm (4x)</p> <p>1/+</p>	<p>C</p>  <p>Flat Head Screw Ø 4,0 x 45mm (27x)</p> <p>2/+</p>	
<p>D</p>  <p>Flat Head Screw Ø4,0 x 14mm (20x)</p> <p>2/+</p>	<p>E</p>  <p>Flat Head Screw MQ M4 x 20mm (6x)</p> <p>1/+</p>	<p>F</p>  <p>Flat Head Screw Ø6,0 x 8mm (8x)</p> <p>1/+</p>	<p>G</p>  <p>Nail 10 x 10 (40x)</p> <p>4/+</p>
<p>H</p>  <p>Glue (2x)</p>	<p>I</p>  <p>Drawer Runners (2x)</p>		<p>J</p>  <p>Hinge Plate (2x)</p>
<p>K</p>  <p>Hinge (2x)</p>	<p>L</p>  <p>Cam Nut 12mm (14x)</p> <p>2/+</p>	<p>M</p>  <p>Cam Bolt (14x)</p> <p>2/+</p>	<p>N</p>  <p>Dowel Ø6,0 x 30mm (46x)</p> <p>2/+</p>
<p>O</p>  <p>Strap 200mm (2x)</p>	<p>P</p>  <p>Plastic Foot (10x)</p> <p>2/+</p>	<p>Q</p>  <p>Handle (3x)</p>	<p>R</p>  <p>Hole Plugs (24x)</p> <p>2/+</p>
<p>S</p>  <p>Washer (4x)</p> <p>1/+</p>	<p>T</p>  <p>Drawer Divider Kit (1x)</p>	<p>U</p>  <p>Drawer Divider Finish (12x)</p>	<p>V</p>  <p>Flat Head Screw Ø 3,5 x 30mm (1x)</p> <p>1/+</p>

TIPS FOR FITTINGS CAM-LOCKS

WHEN FITTING CAM NUT, ENSURE STARTING POSITION IS CORRECT BEFORE YOU INSERT CONNECTING CAM BOLT TURN CLOCKWISE UNTIL SECURE

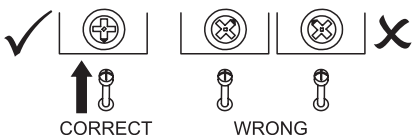

CORRECT WRONG

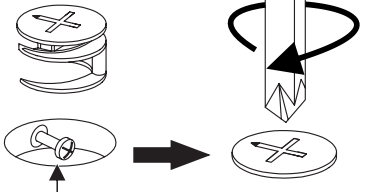

Cam bolt head needs to be in centre

CAMBOLT

Tighten until shoulder is flush with panel. Do not overtighten or undertighten (see example beside)

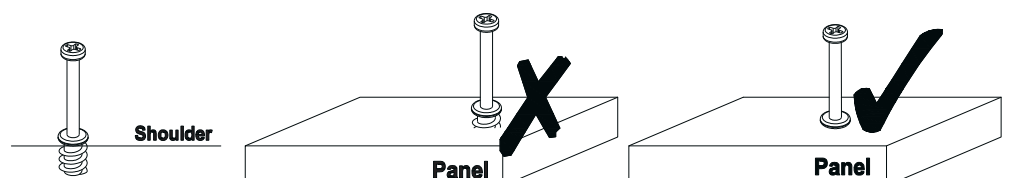

STEP 1

PARTS REQUIRED

3 - LEFT SIDE PANEL (RED) x1

HARDWARE REQUIRED

D  04
Ø4,0 x 14mm

H  01

J  02

N  02
Ø6,0 x 30mm

TOOLS REQUIRED

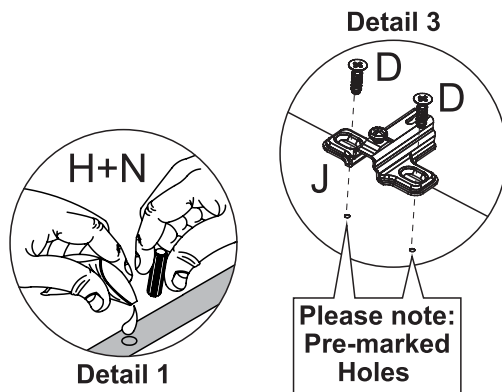
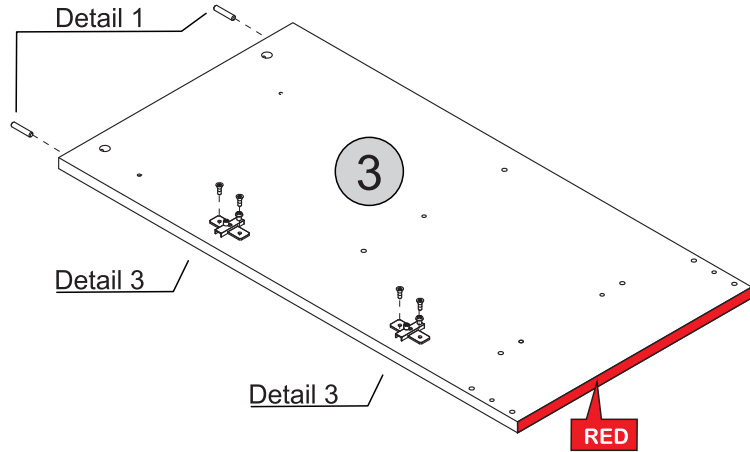
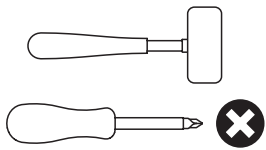



STEP 2

PARTS REQUIRED

3 - LEFT SIDE PANEL (RED) x1

HARDWARE REQUIRED

F  02
Ø6,0 x 8mm

G  02

I  01
Left

P  02

TOOLS REQUIRED

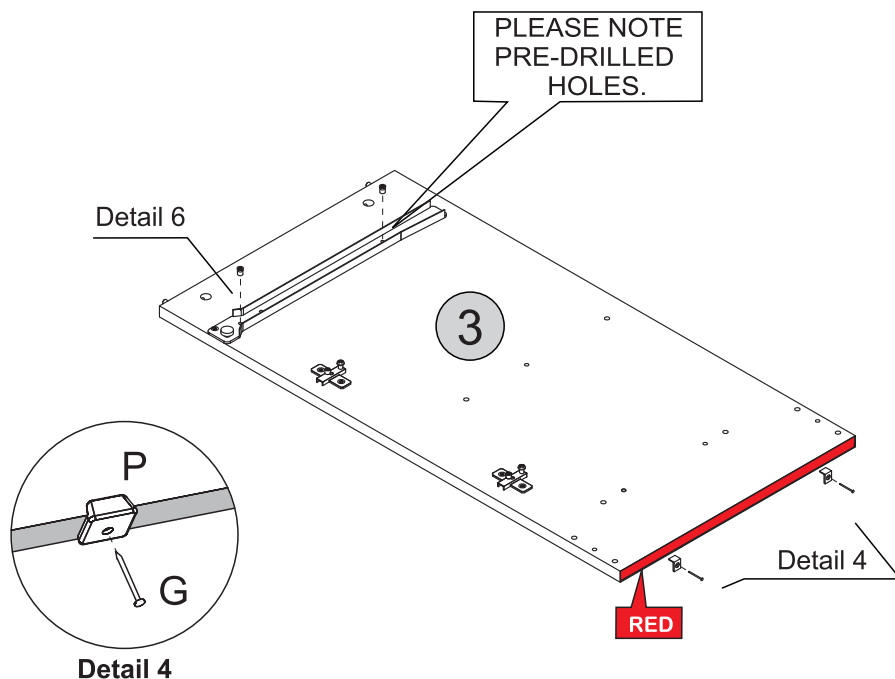
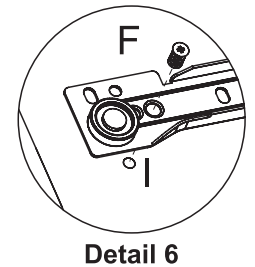
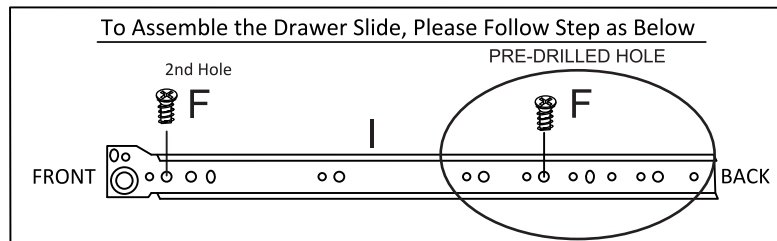
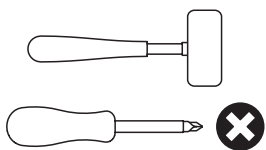

STEP 3

PARTS REQUIRED

5- LEFT DIVISION PANEL (GREEN) x1

HARDWARE REQUIRED

F  02
Ø6,0 x 8mm

H  01

I  Right 01

N  02
Ø6,0 x 30mm

TOOLS REQUIRED

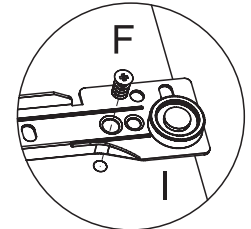
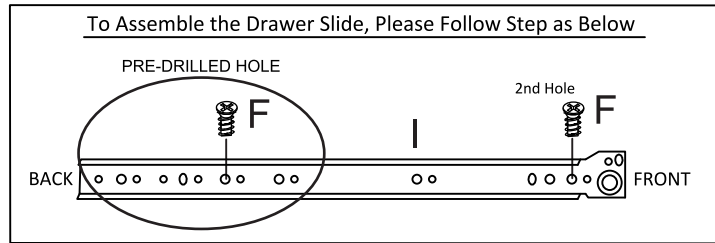
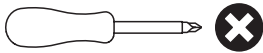
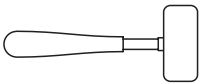

Detail 6

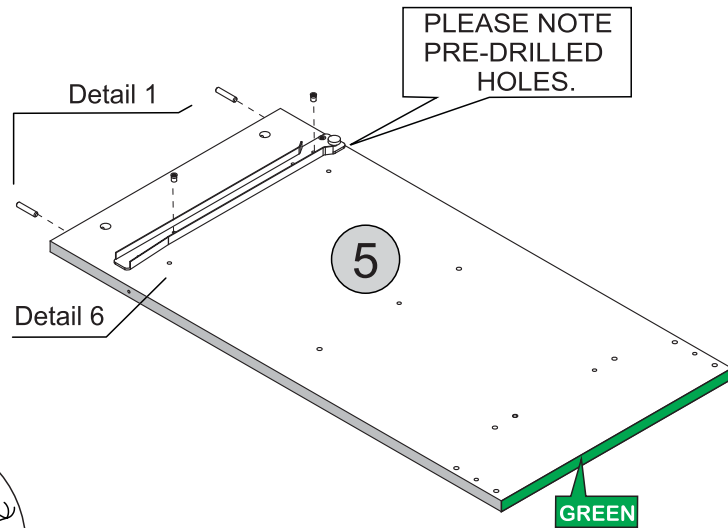

Detail 1

STEP 4

PARTS REQUIRED

5- LEFT DIVISION PANEL (GREEN) x1

HARDWARE REQUIRED

F  02
Ø6,0 x 8mm

G  02

I  Left 01

P  02

TOOLS REQUIRED

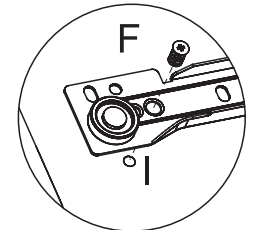
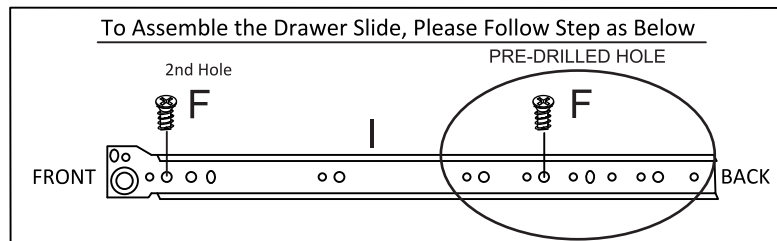
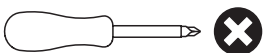
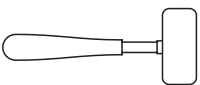

Detail 6

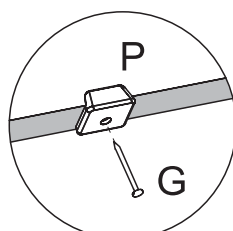
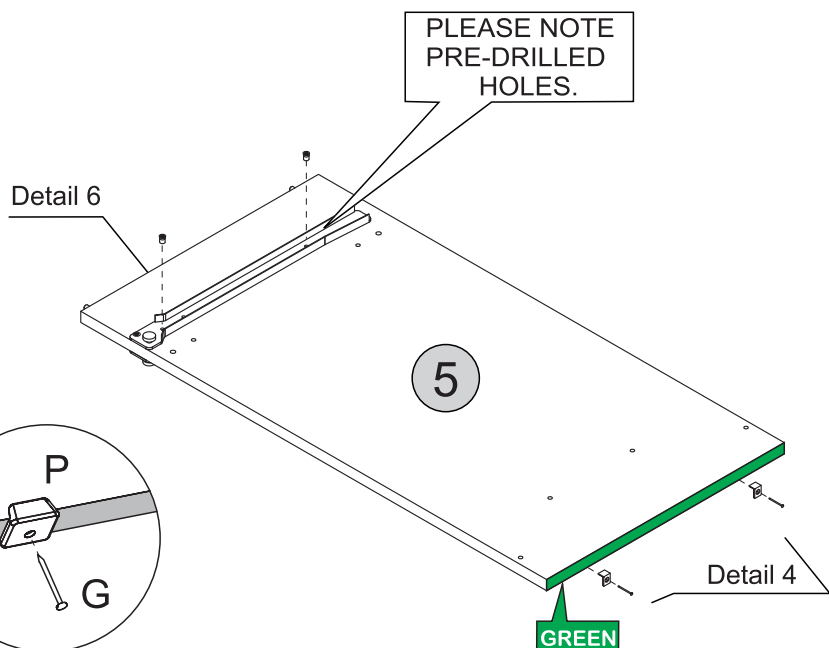

Detail 4

STEP 5

PARTS REQUIRED

8 - RIGHT SIDE PANEL (BLUE) x1

HARDWARE REQUIRED

F  02
Ø6,0 x 8mm

G  02

H  01

I  Right 01

N  02
Ø6,0 x 30mm

P  02

TOOLS REQUIRED

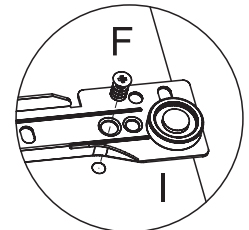
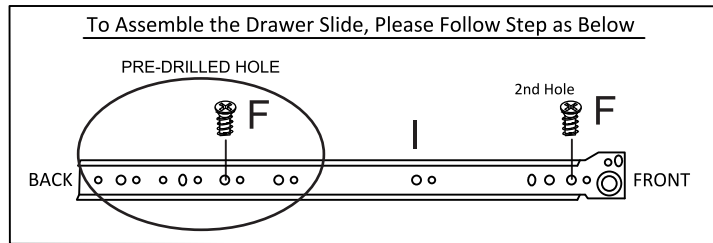
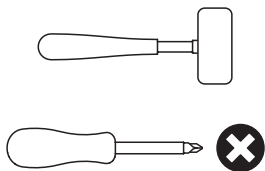

Detail 6

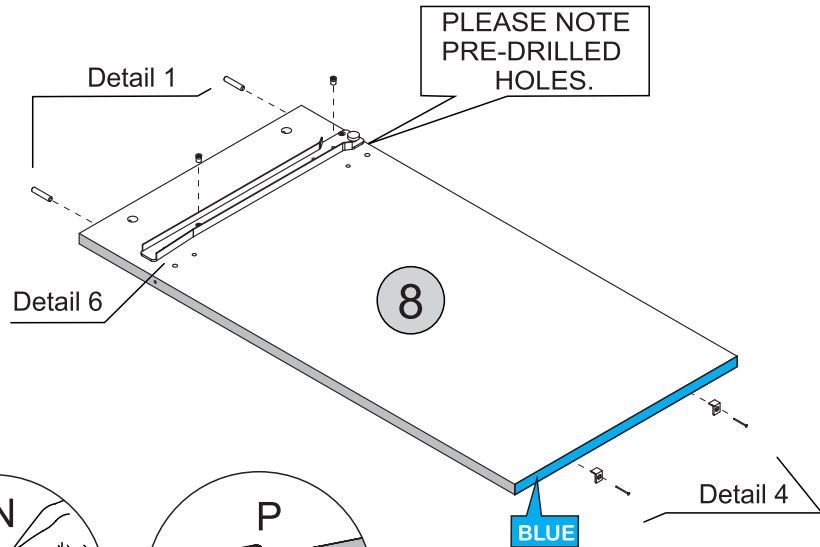

Detail 1

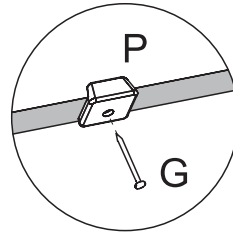

Detail 4

STEP 6

PARTS REQUIRED

1 - FRONT BASEBOARD (BLUE) x1

2 - BACK BASEBOARD (RED) x1

4 - BASE PANEL (BLACK) x1

HARDWARE REQUIRED

H  01

N  12
Ø6,0 x 30mm

TOOLS REQUIRED

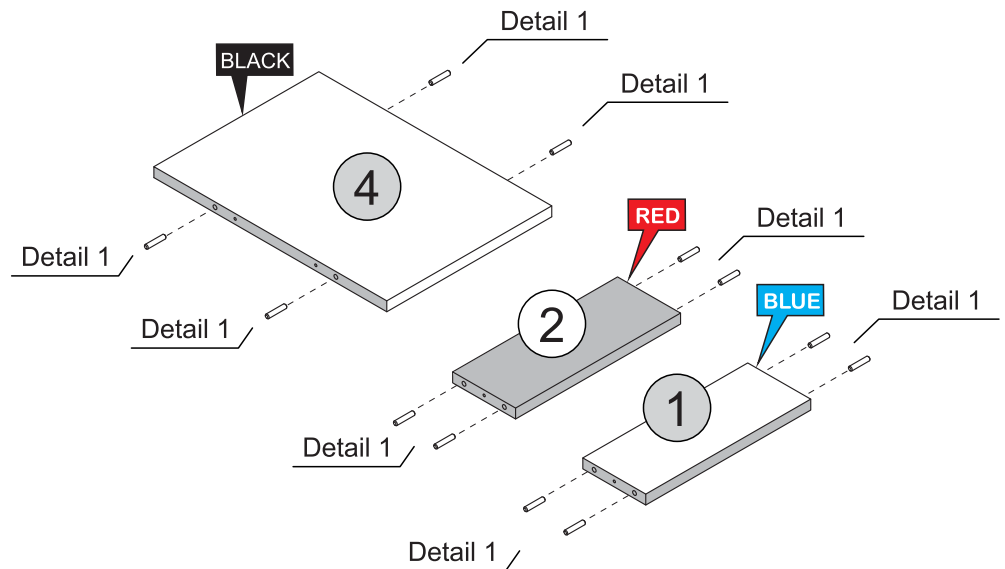
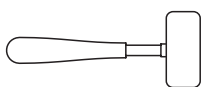

Detail 1

STEP 7

PARTS REQUIRED

6 - FRONT CROSSBAR (BLUE) x1

7 - BACK CROSSBAR (YELLOW) x1

15 - SHELF (RED) x1

HARDWARE REQUIRED

H  01

N  Ø6,0 x 30mm 10

TOOLS REQUIRED

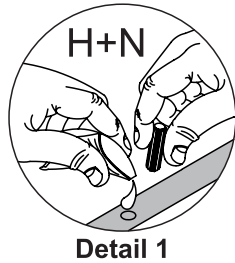
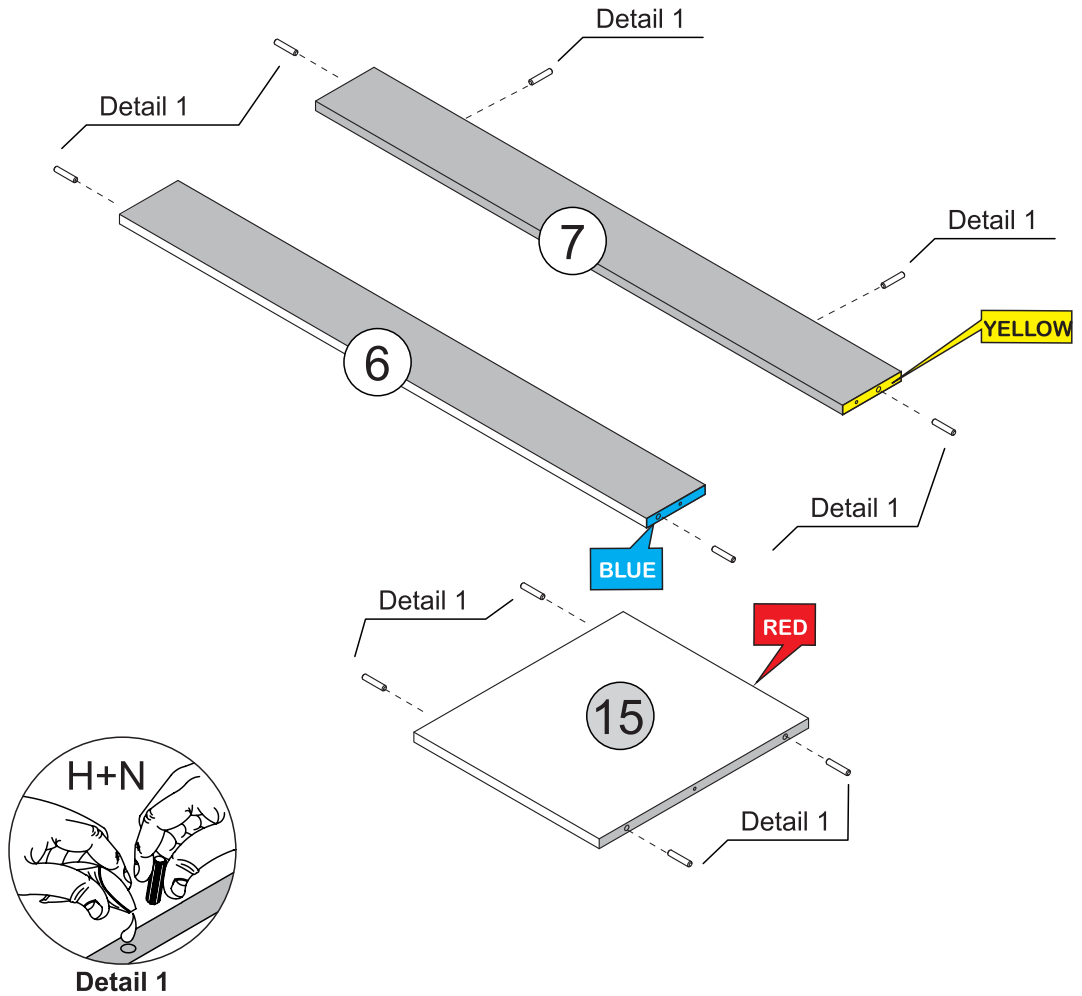
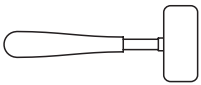

STEP 8

PARTS REQUIRED

9 - TOP PANEL (RED) x1

HARDWARE REQUIRED

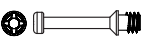
M  06

TOOLS REQUIRED

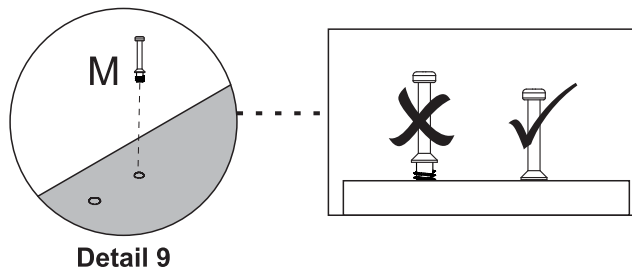
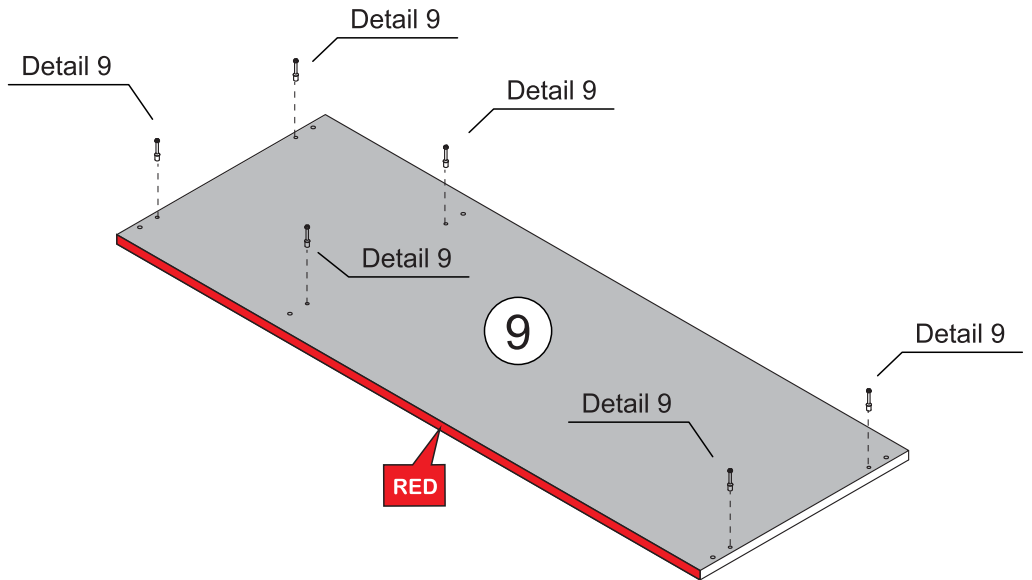
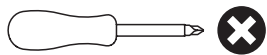



STEP 9

PARTS REQUIRED

- 5 - LEFT DIVISION PANEL (GREEN) x1
- 6 - FRONT CROSSBAR (BLUE) x1
- 7 - BACK CROSSBAR (YELLOW) x1
- 8 - RIGHT SIDE PANEL (BLUE) x1

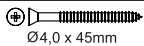
HARDWARE REQUIRED

- C  04
Ø4,0 x 45mm
- H  01

TOOLS REQUIRED

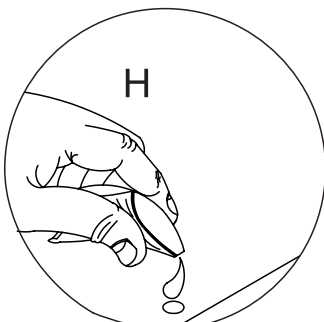
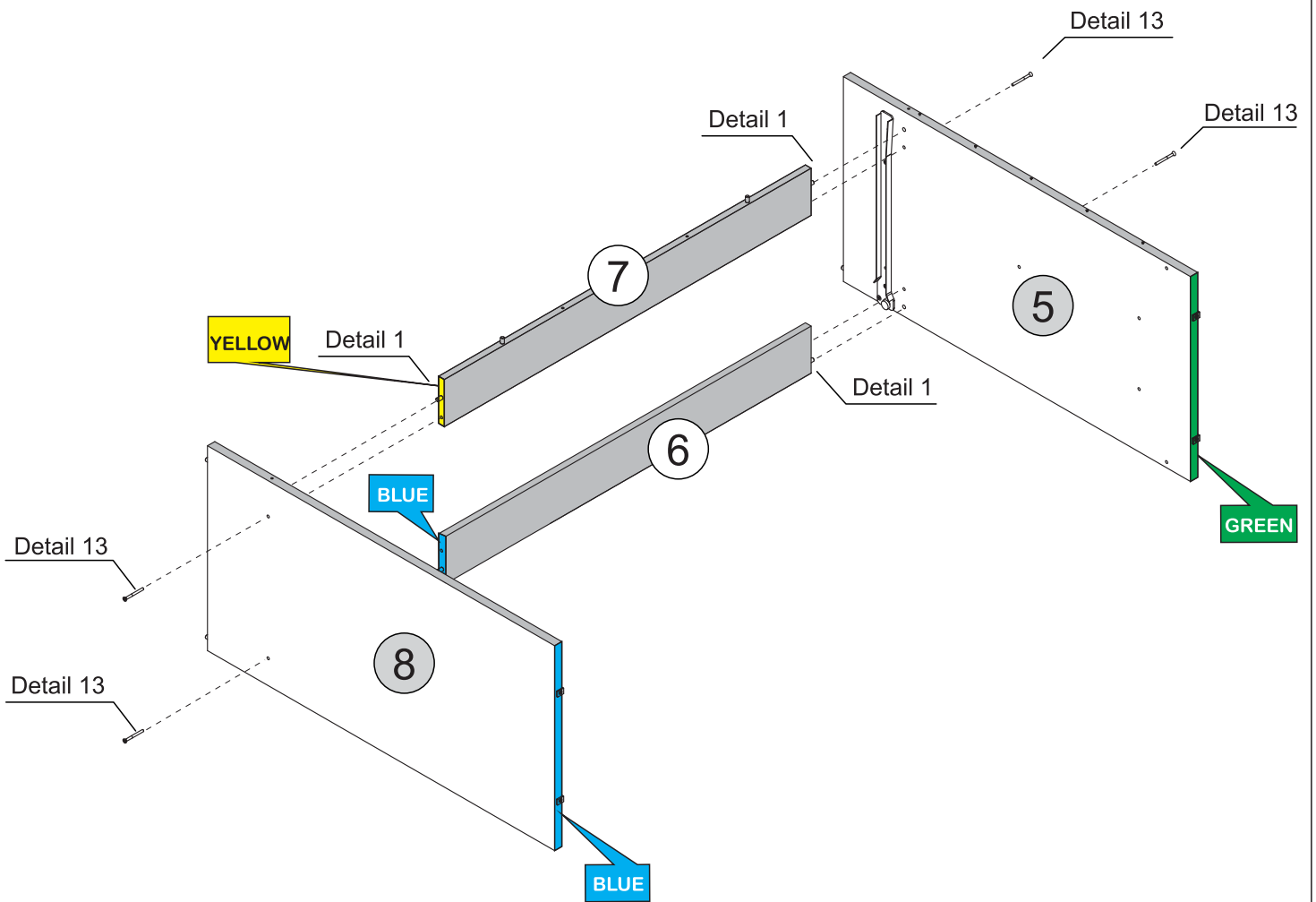
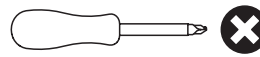

Detail 1

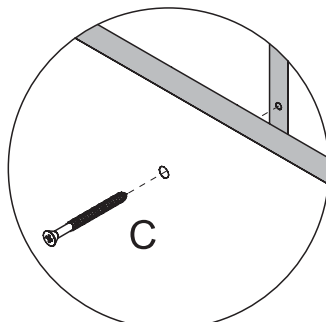

Detail 13

STEP 10

PARTS REQUIRED

4 - BASE PANEL (BLACK) x1

15 - SHELF (RED) x1

HARDWARE REQUIRED

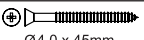
C  03
Ø4,0 x 45mm

H  01

TOOLS REQUIRED

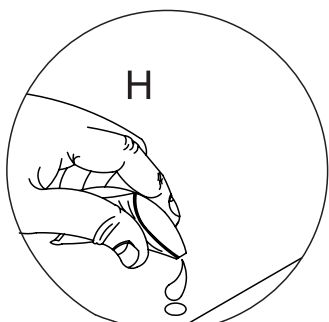
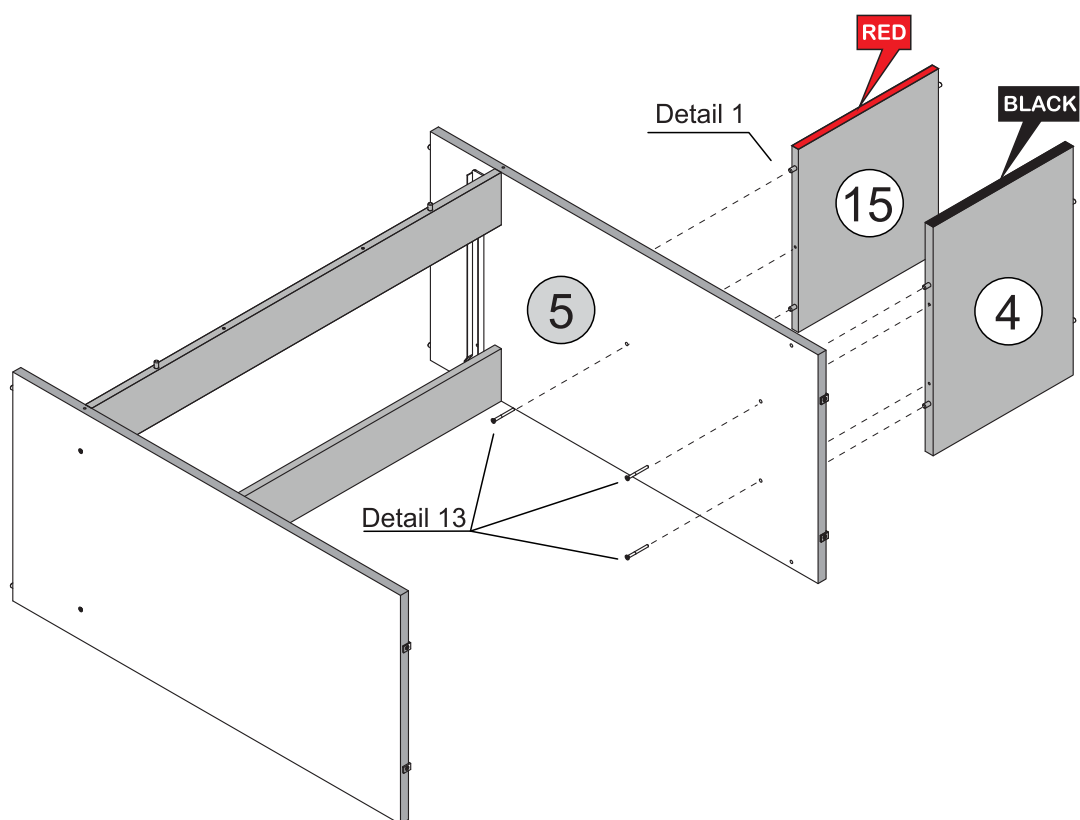
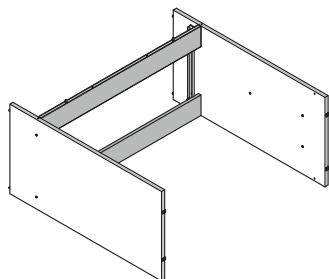
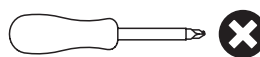

Detail 1

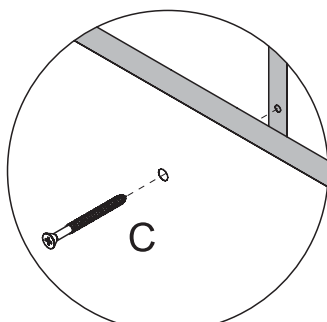

Detail 13

STEP 11

PARTS REQUIRED

1 - FRONT BASEBOARD (BLUE) x1

2 - BACK BASEBOARD (RED) x1

HARDWARE REQUIRED

C  Ø4,0 x 45mm 02

H  01

TOOLS REQUIRED

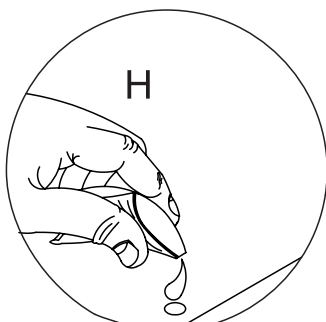
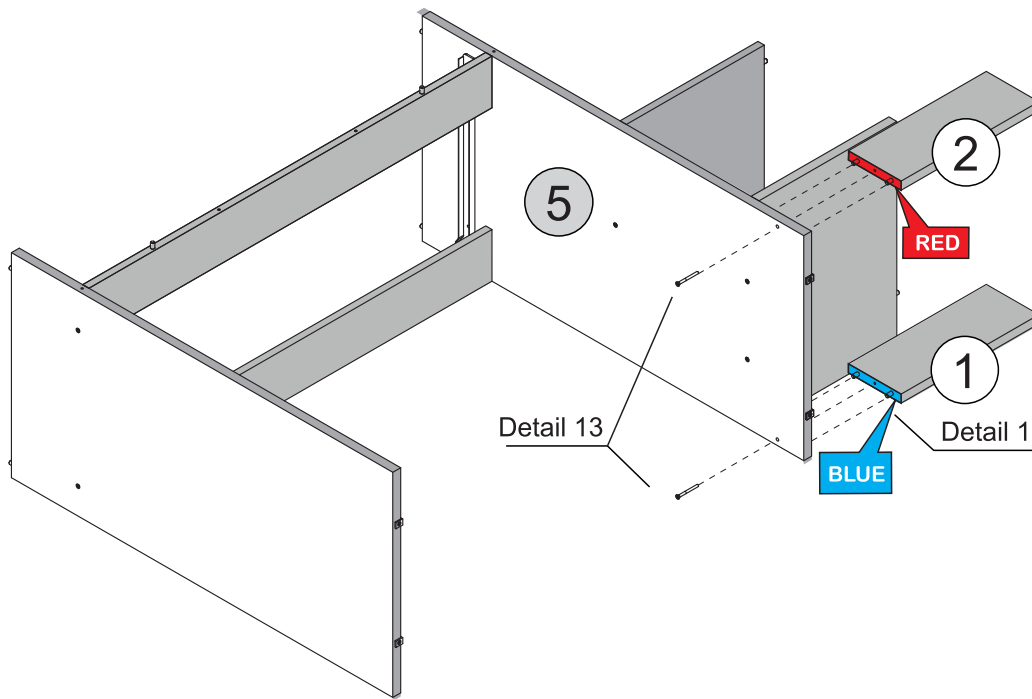
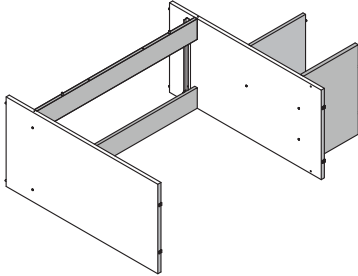
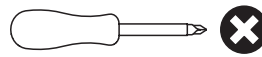

Detail 1

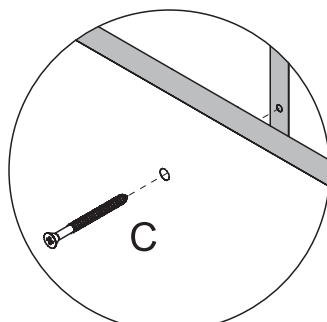

Detail 13

STEP 12

PARTS REQUIRED

3 - LEFT SIDE PANEL (RED) x1

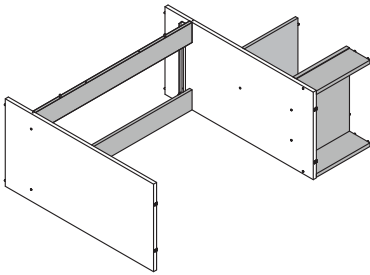

HARDWARE REQUIRED

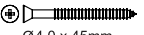
C  05
Ø4,0 x 45mm

H  01
Glue

TOOLS REQUIRED

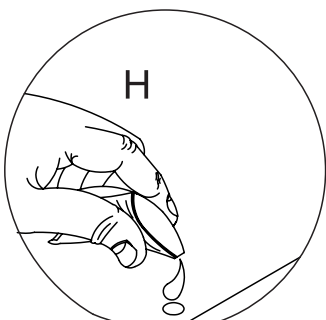
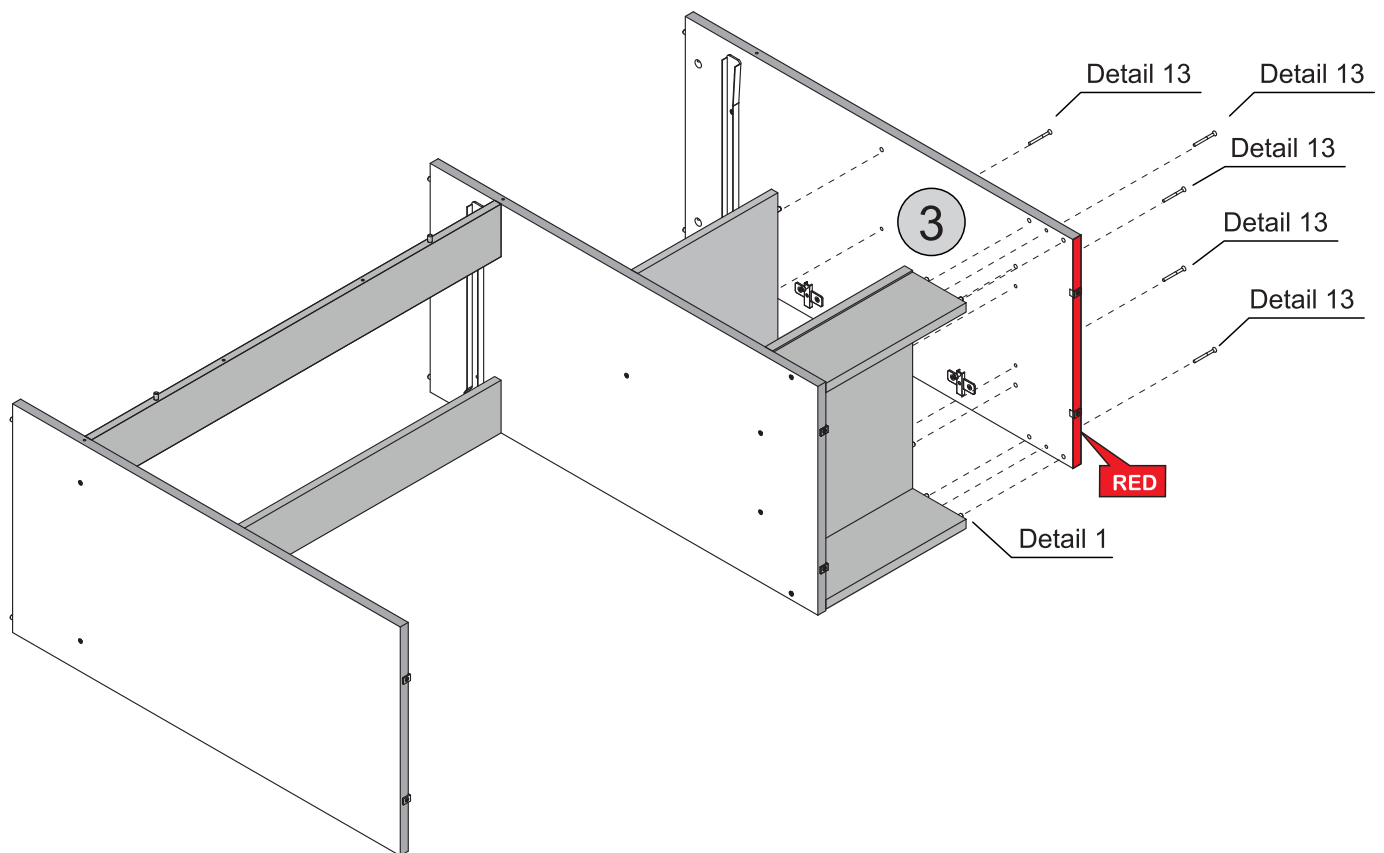
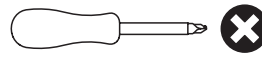

Detail 1

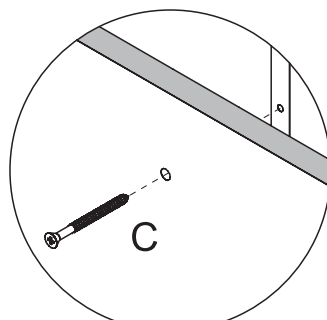

Detail 13

STEP 13

PARTS REQUIRED

9 - TOP PANEL (RED) x1

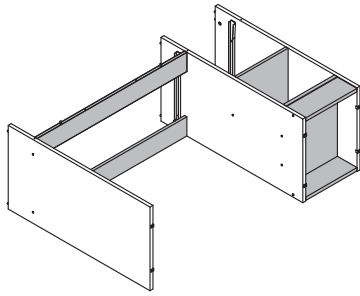

HARDWARE REQUIRED

H  01

L  06

TOOLS REQUIRED

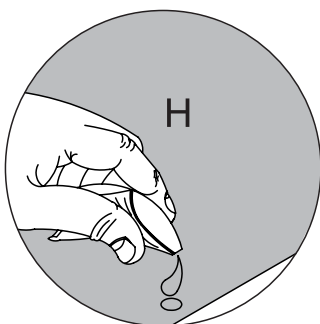
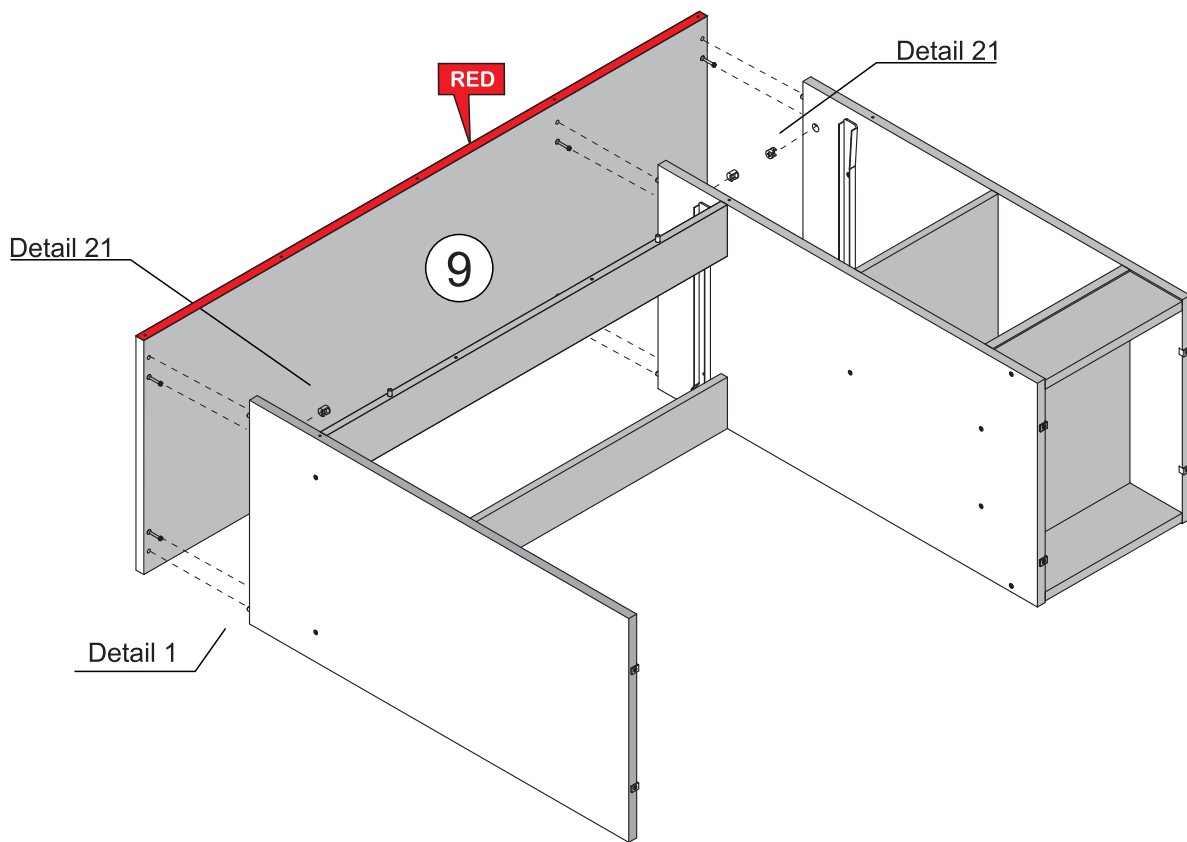
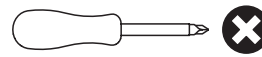

Detail 1

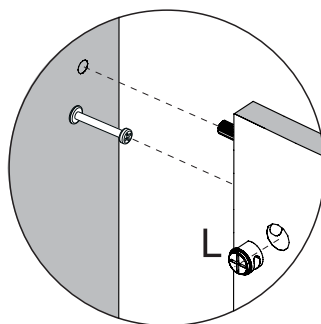

Detail 21

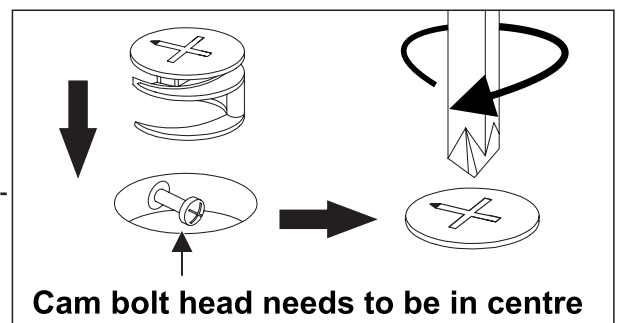

STEP 14

PARTS REQUIRED

10 - MIRROR PANEL (BLUE) x1

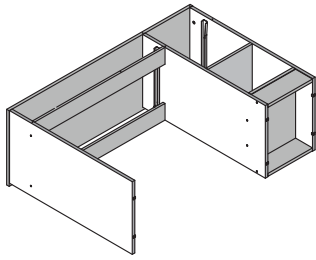

HARDWARE REQUIRED

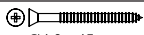
C  09
Ø4,0 x 45mm

H  01

TOOLS REQUIRED

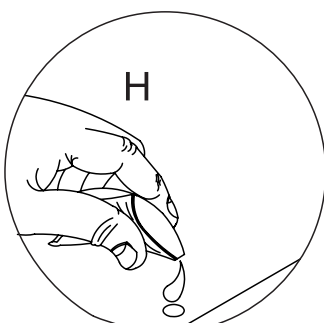
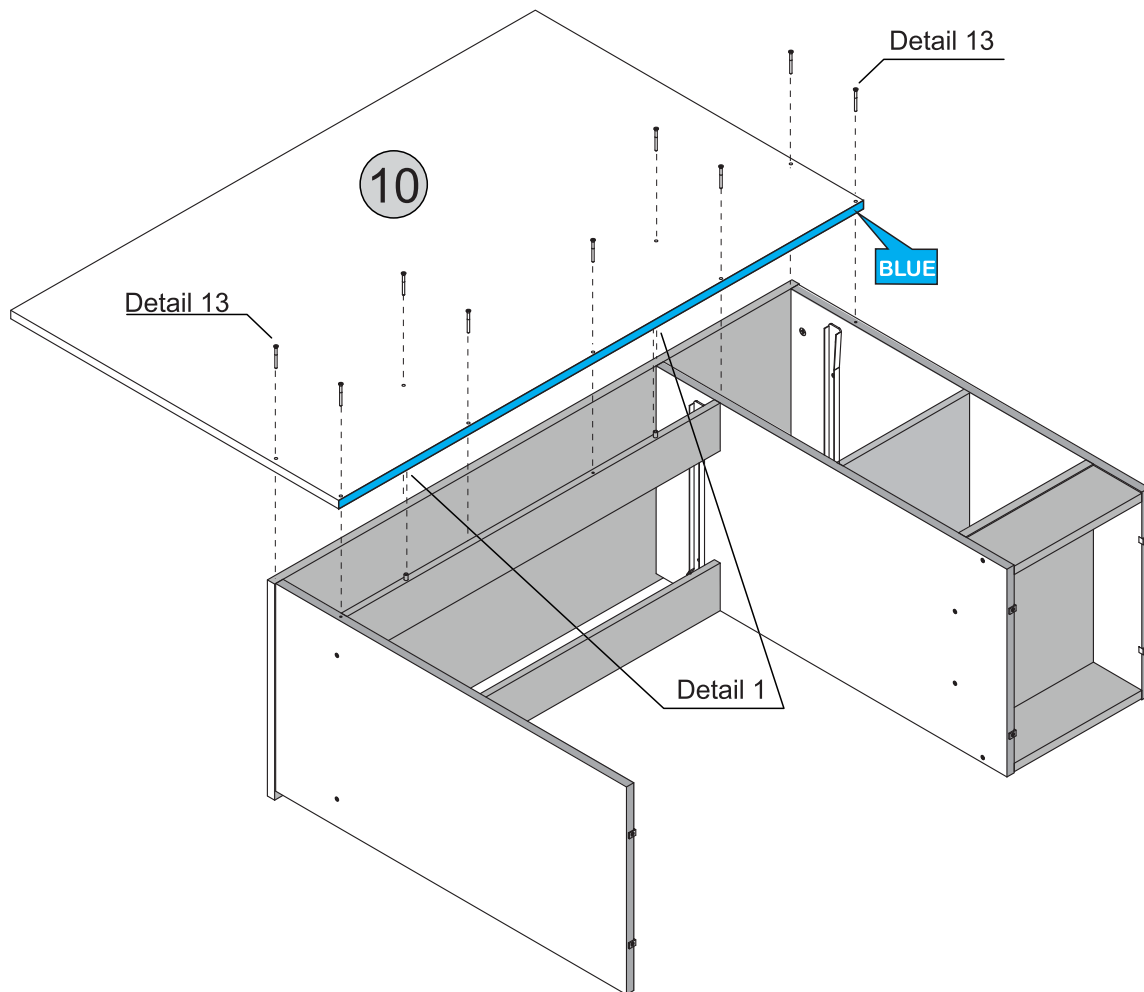
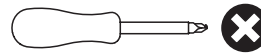

Detail 1

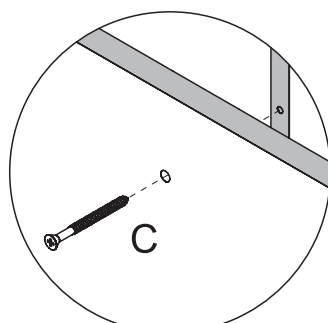

Detail 13

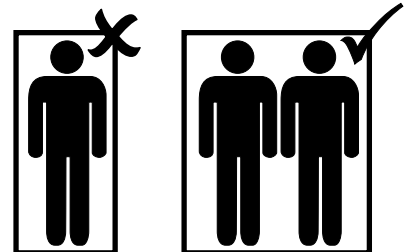

* You should assemble this product with two people

STEP 15

PARTS REQUIRED

11 - BACK PANEL x1

HARDWARE REQUIRED

G  12
10 x 10

TOOLS REQUIRED

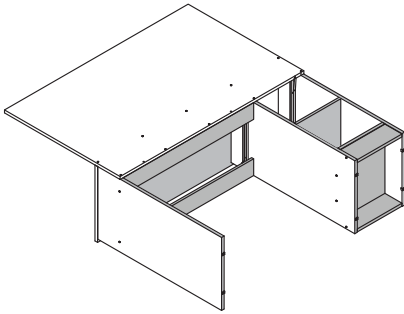
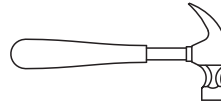

* For your future reference Order Number should be here.

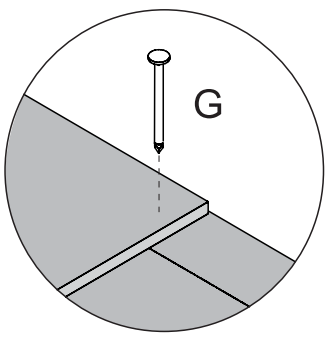
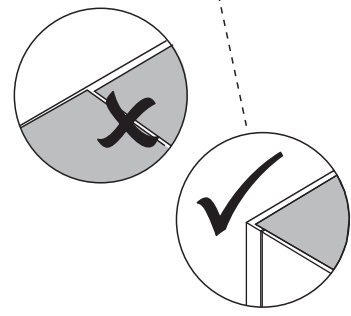
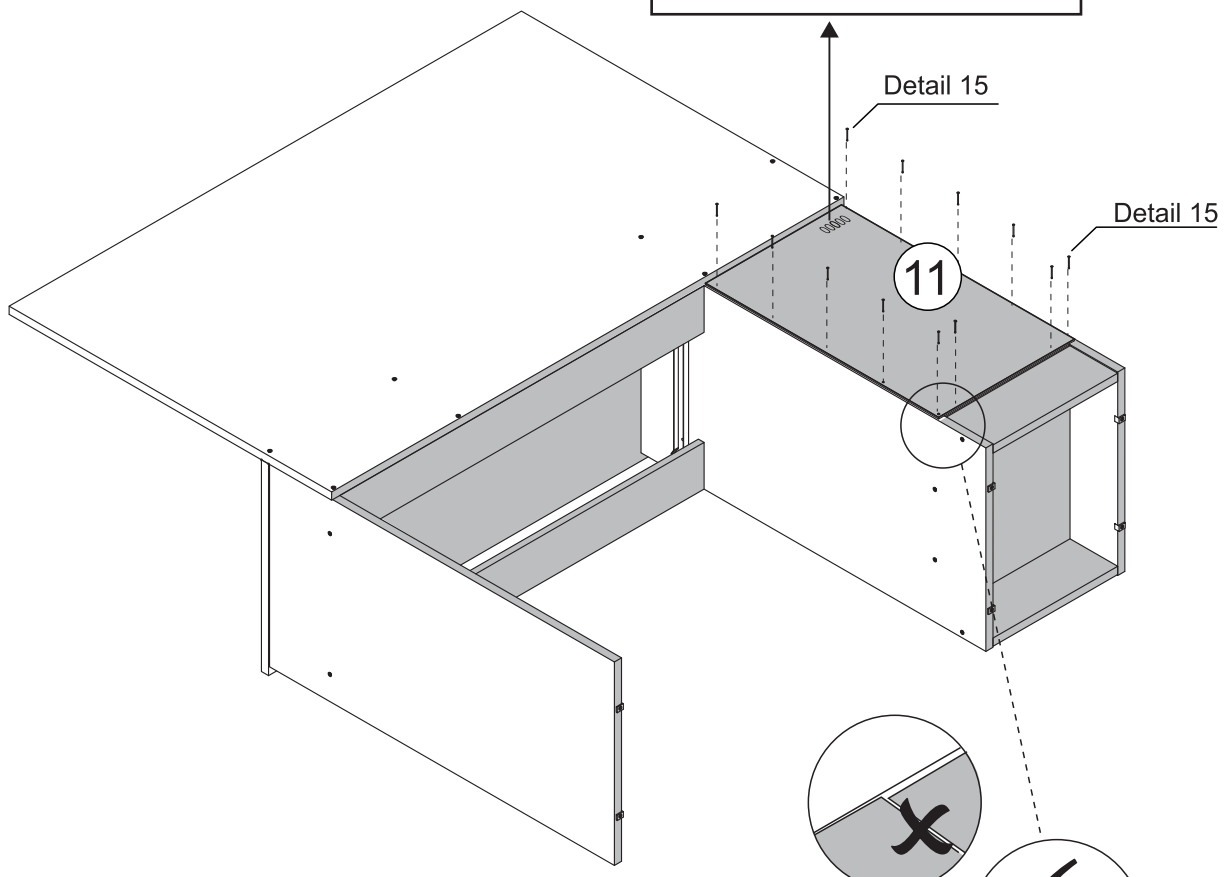

Detail 15

STEP 16

PARTS REQUIRED

16 - DRAWER SIDE (BLUE) x2

17 - LARGE DRAWER BACK PANEL (RED) x1

20 - DRAWER BOTTOM SUPPORT BAR (BLACK) x1

HARDWARE REQUIRED

H  01

N  Ø6,0 x 30mm 06

TOOLS REQUIRED

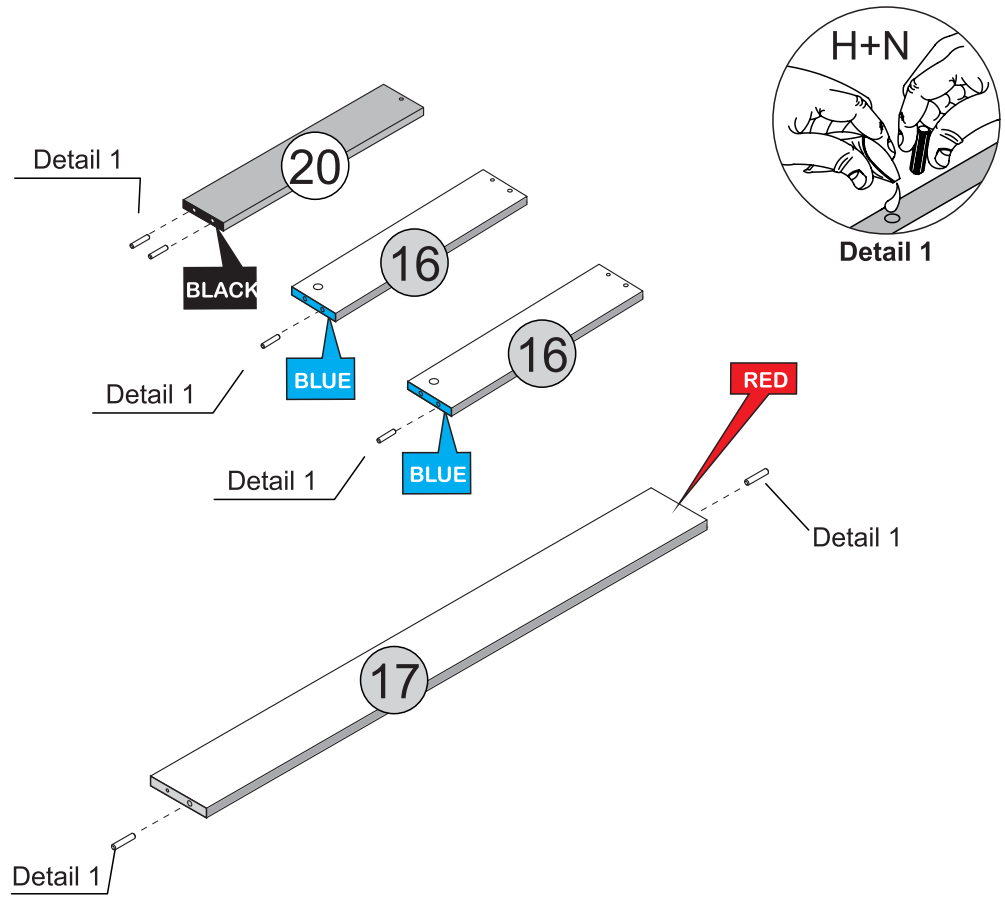
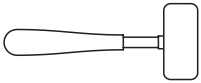

STEP 17

PARTS REQUIRED

18 - LARGE DRAWER FRONT x1

HARDWARE REQUIRED

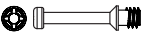
M  02

TOOLS REQUIRED

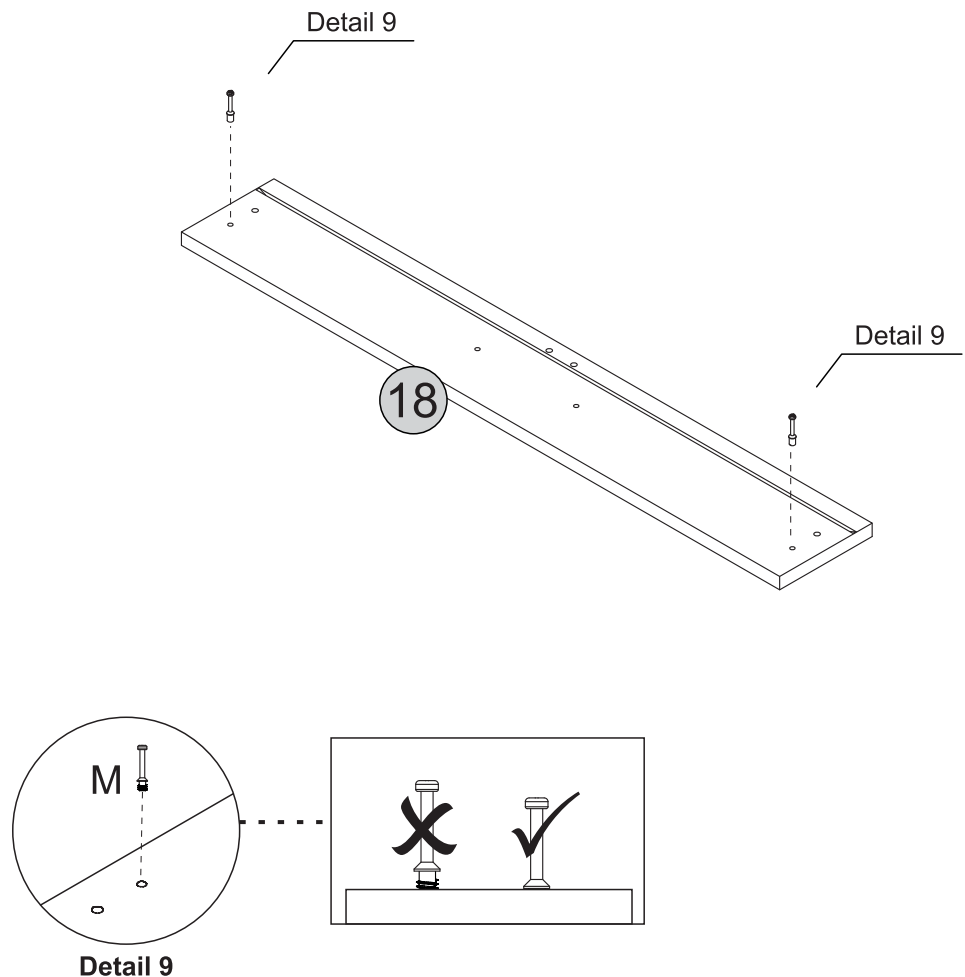
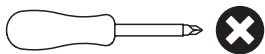

STEP 18

PARTS REQUIRED

16 - DRAWER SIDE (BLUE) x2

17 - LARGE DRAWER BACK PANEL (RED) x1

HARDWARE REQUIRED

C  Ø4,0 x 45mm 02

H  01

TOOLS REQUIRED

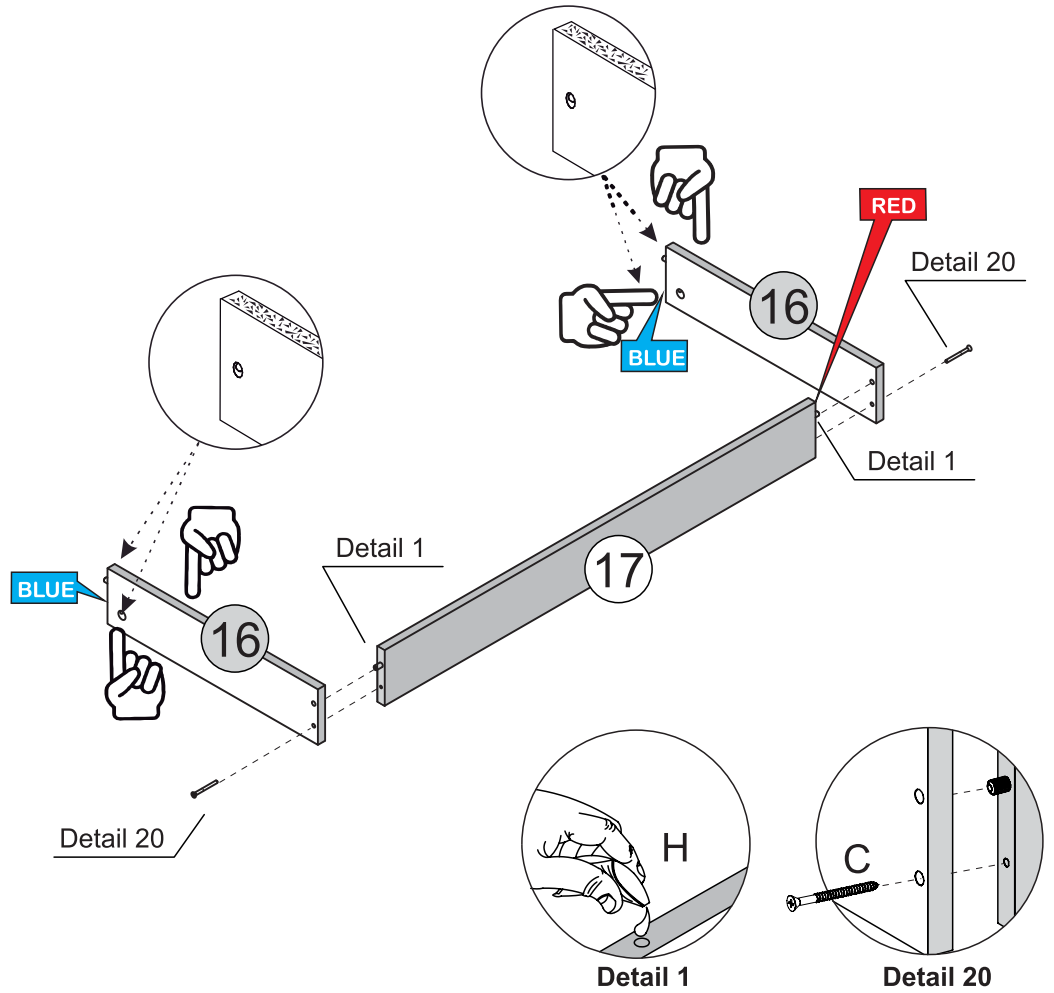
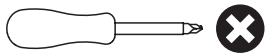

STEP 19

PARTS REQUIRED

18 - LARGE DRAWER FRONT x1

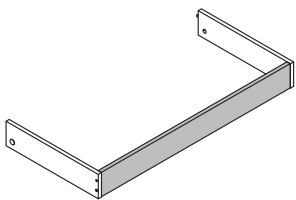

HARDWARE REQUIRED

H  01

TOOLS REQUIRED

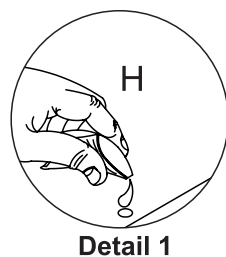
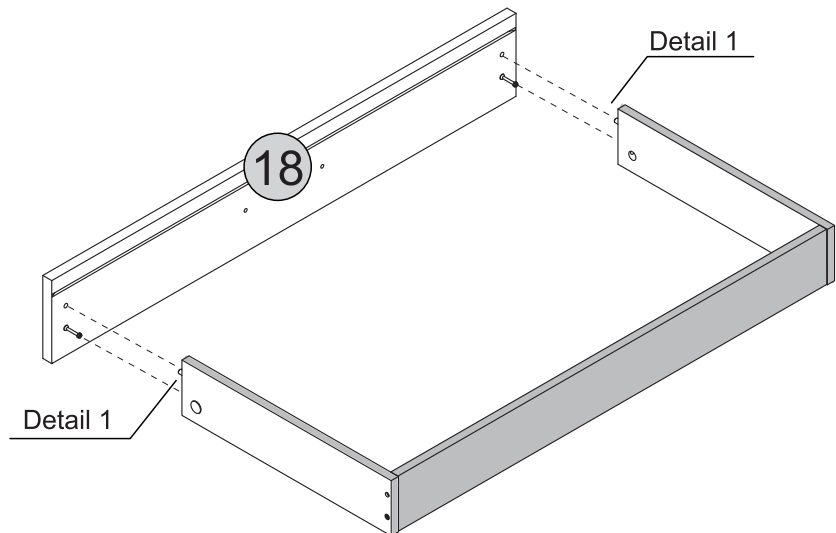

STEP 20

PARTS REQUIRED

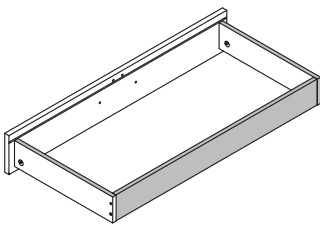

HARDWARE REQUIRED

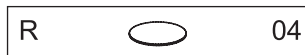
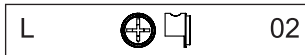

TOOLS REQUIRED

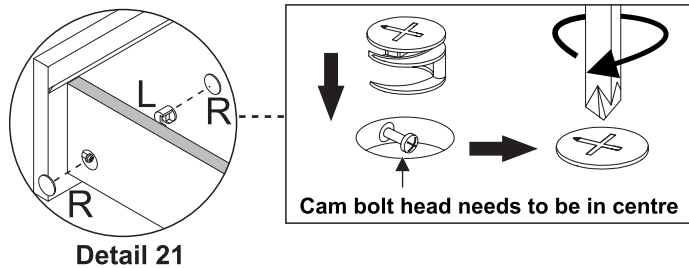
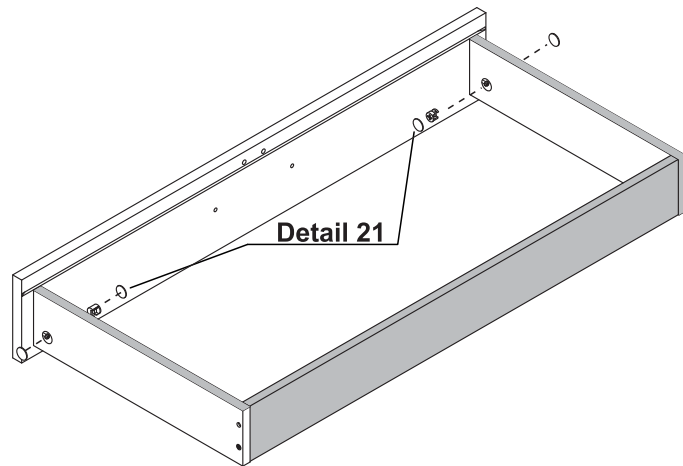
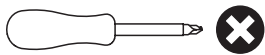

Detail 21

STEP 21

PARTS REQUIRED

19 - LARGE DRAWER BOTTOM x1

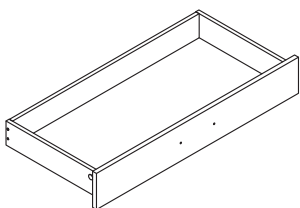

HARDWARE REQUIRED

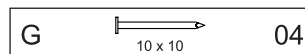

TOOLS REQUIRED

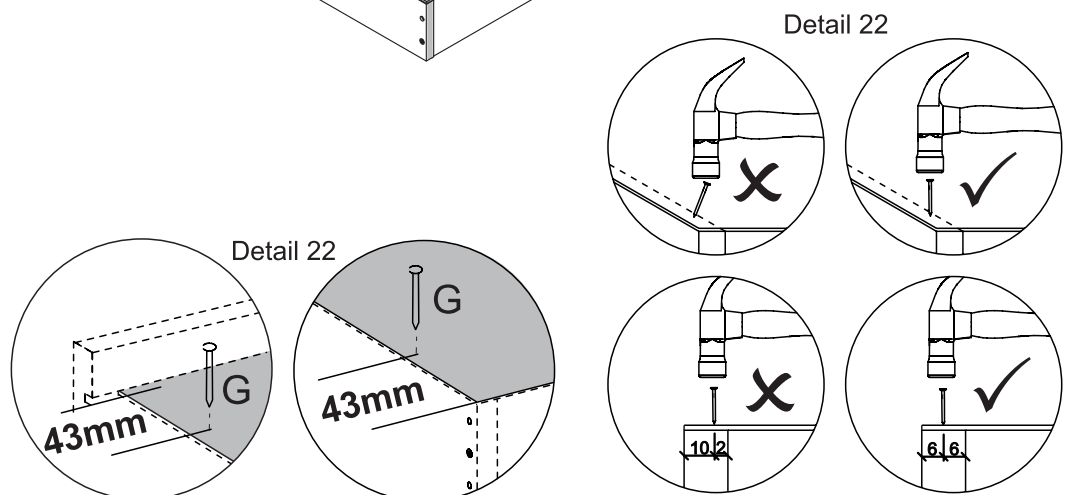
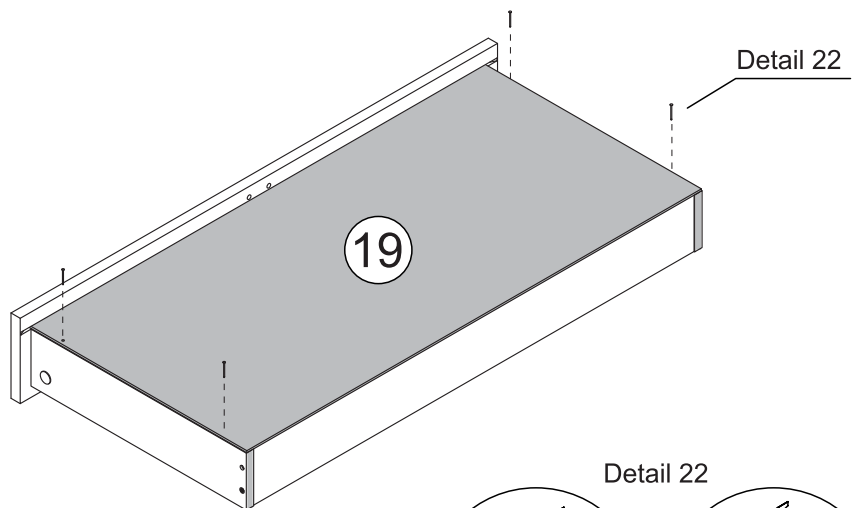
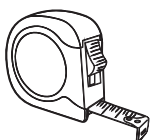
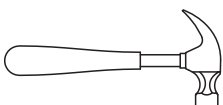

Detail 22

STEP 22

PARTS REQUIRED

20 - DRAWER BOTTOM SUPPORT BAR (BLACK) X 1

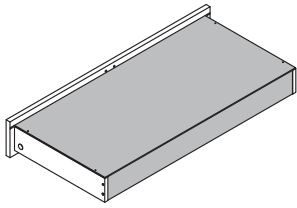

HARDWARE REQUIRED

G  06

H  01

TOOLS REQUIRED

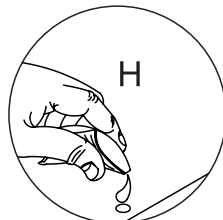
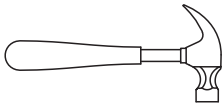

Detail 1

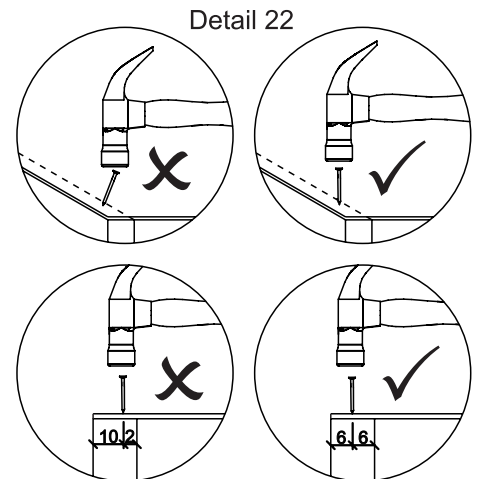
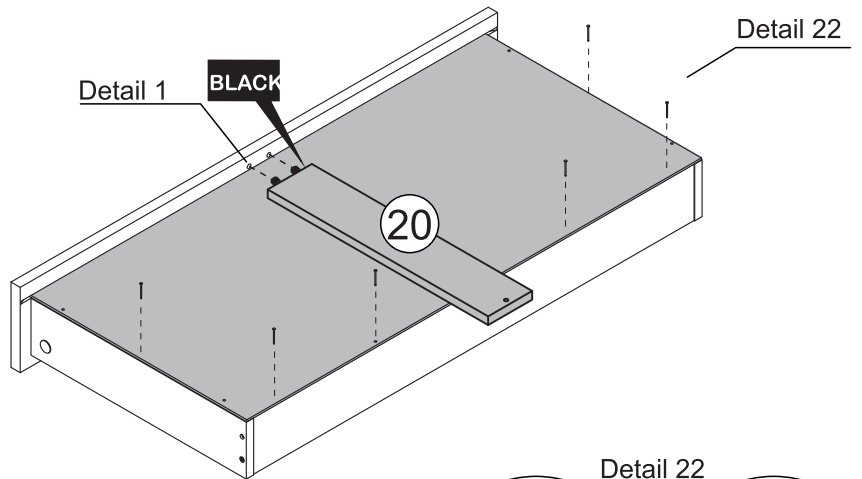

STEP 23

PARTS REQUIRED

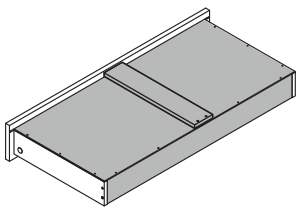

HARDWARE REQUIRED

D  04

I  01

I  01

V  01

TOOLS REQUIRED

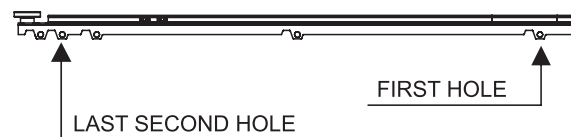
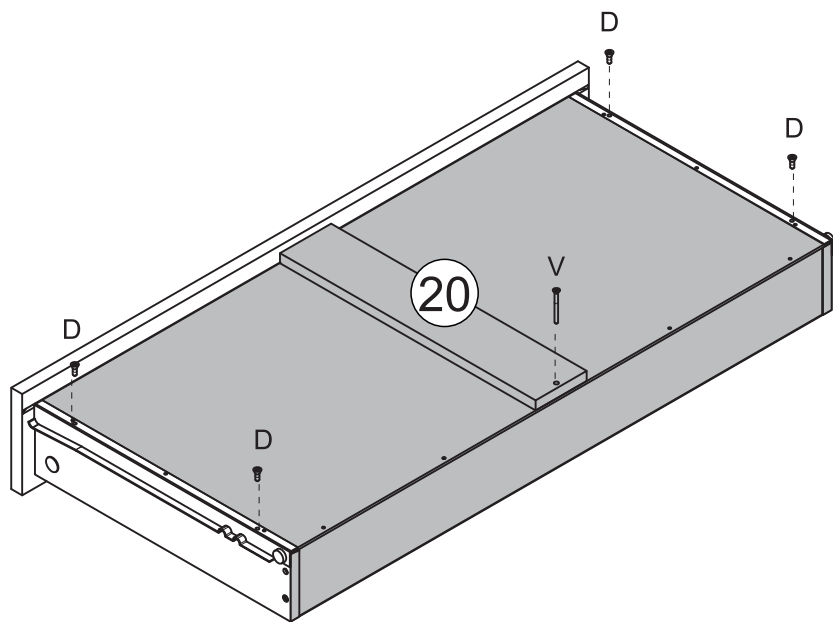
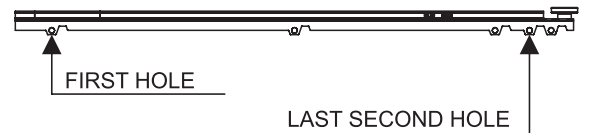

STEP 24

PARTS REQUIRED

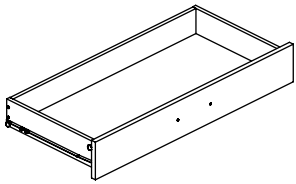

HARDWARE REQUIRED

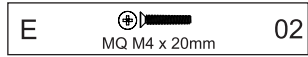

TOOLS REQUIRED

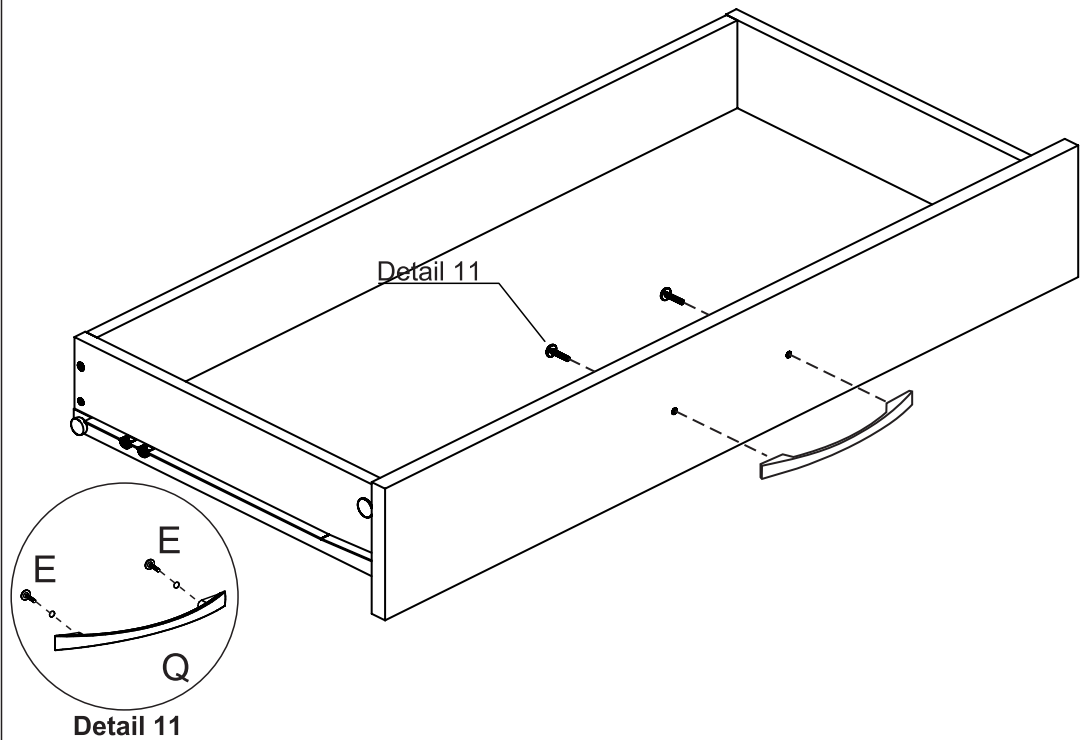
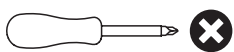

STEP 25

PARTS REQUIRED

HARDWARE REQUIRED

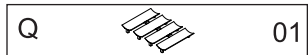
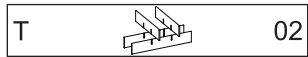

TOOLS REQUIRED

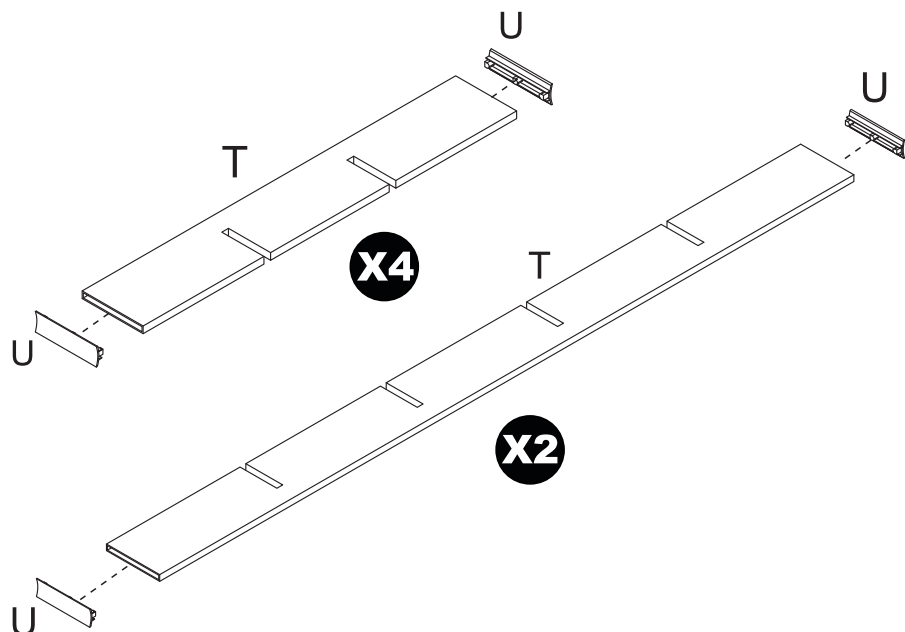
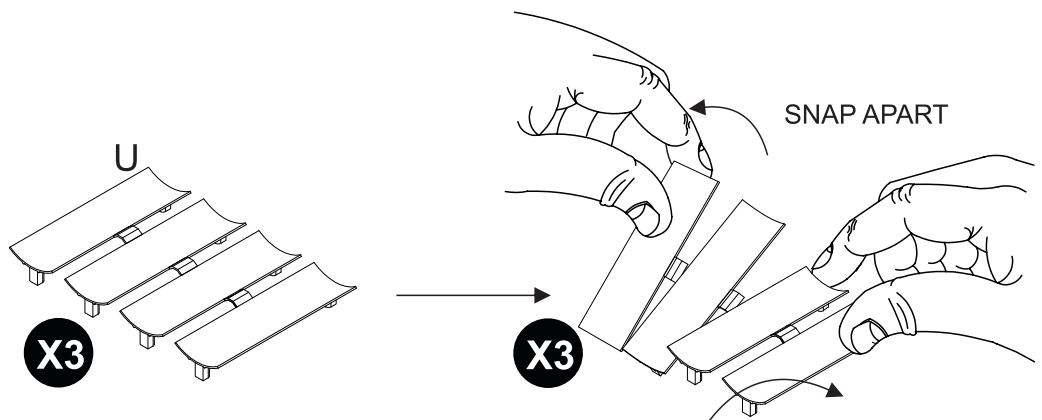

STEP 26

PARTS REQUIRED

HARDWARE REQUIRED

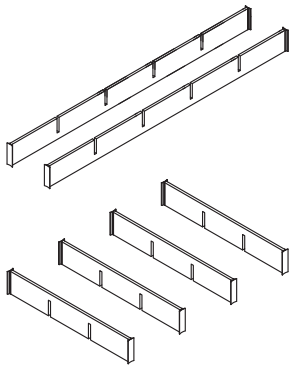

TOOLS REQUIRED

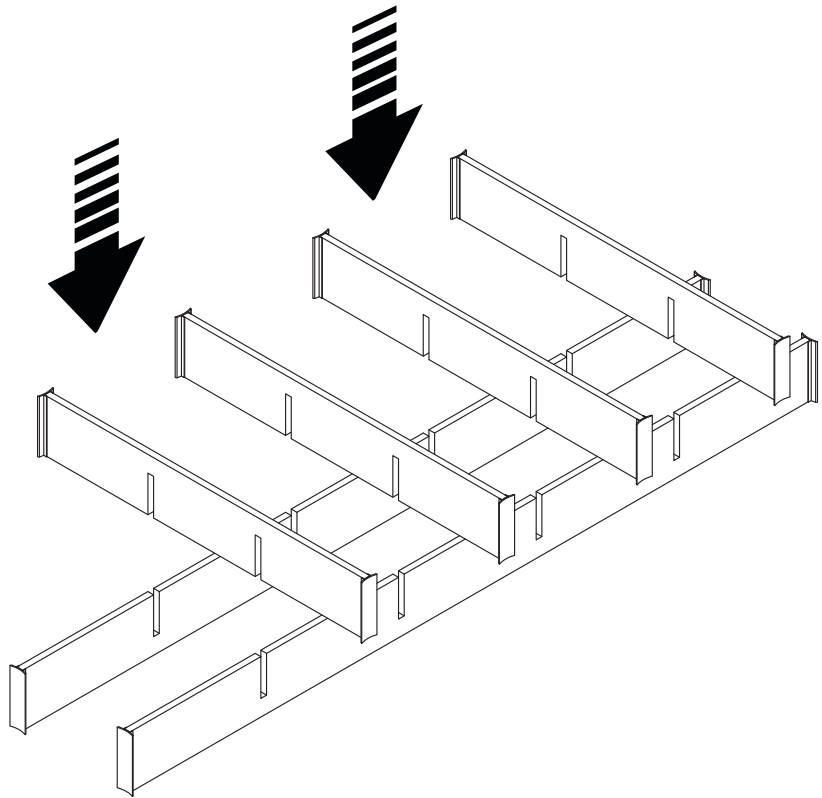

STEP 27

PARTS REQUIRED

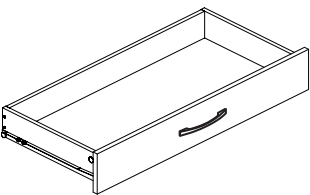

HARDWARE REQUIRED

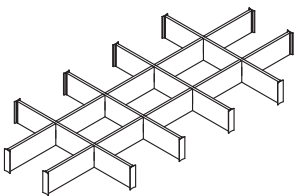

TOOLS REQUIRED

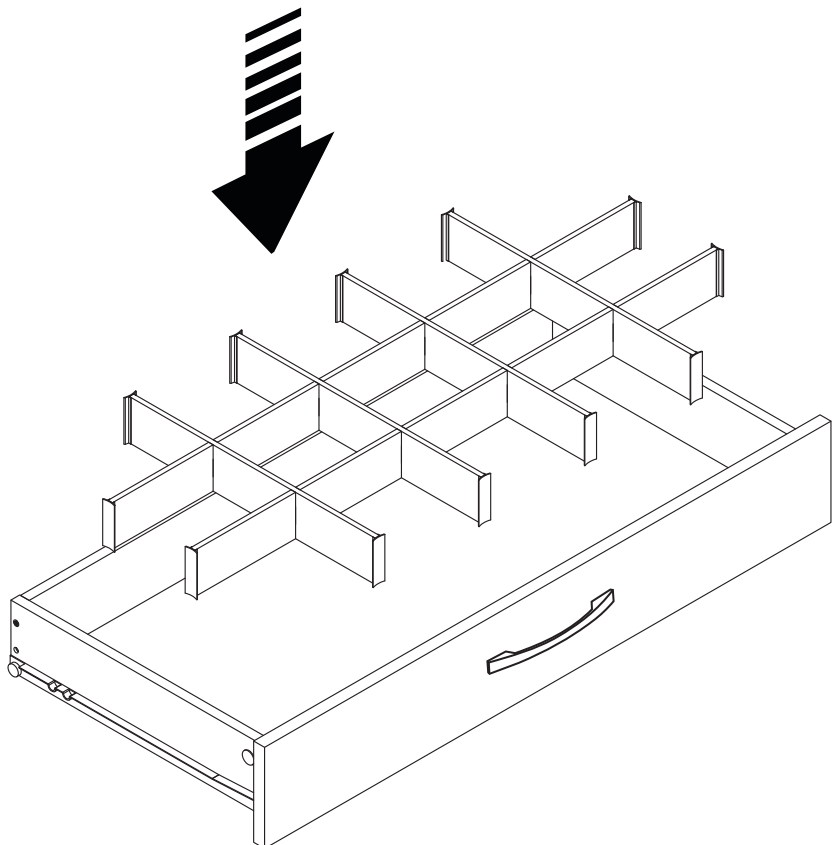

STEP 28

PARTS REQUIRED

16 - DRAWER SIDE (BLUE) x2

21 - SMALL DRAWER BACK PANEL (RED) x1

22 - SMALL DRAWER FRONT x1

HARDWARE REQUIRED

H  01

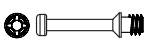
M  02

N  Ø6,0 x 30mm 04

TOOLS REQUIRED

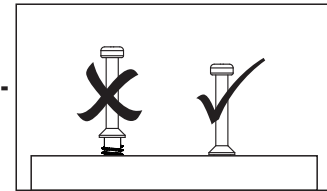
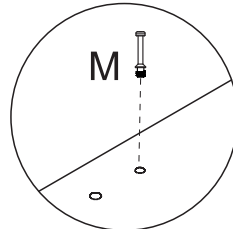
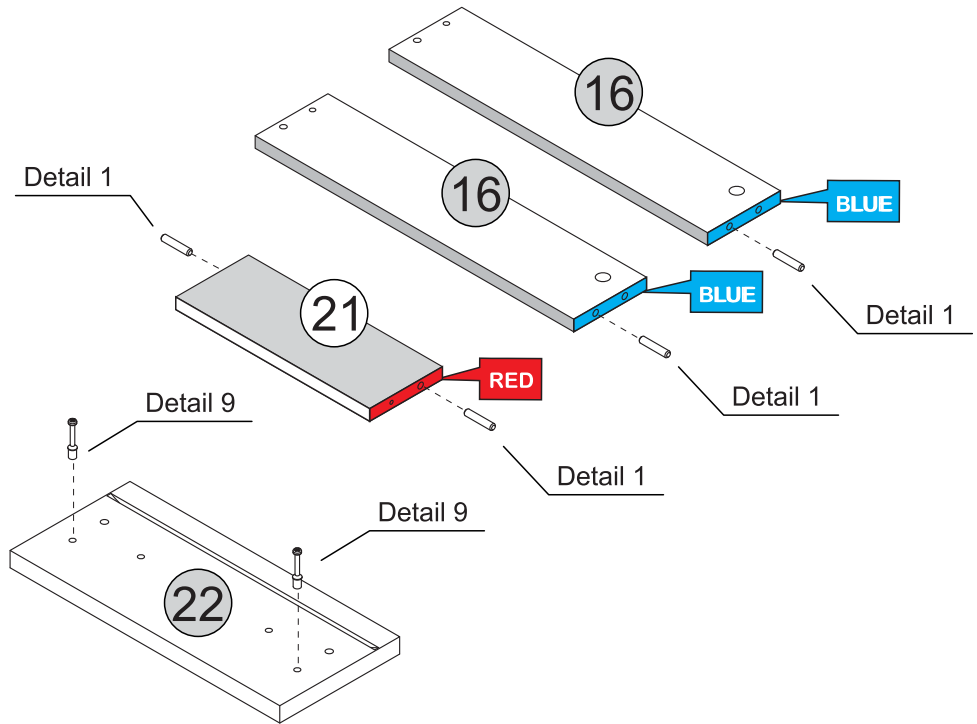
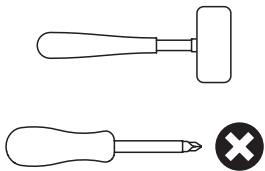

Detail 1

Detail 9

STEP 29

PARTS REQUIRED

16 - DRAWER SIDE (BLUE) x2

21 - SMALL DRAWER BACK PANEL (RED) x1

HARDWARE REQUIRED

C  Ø4,0 x 45mm 02

H  01

TOOLS REQUIRED

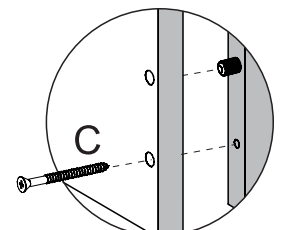
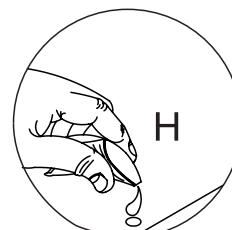
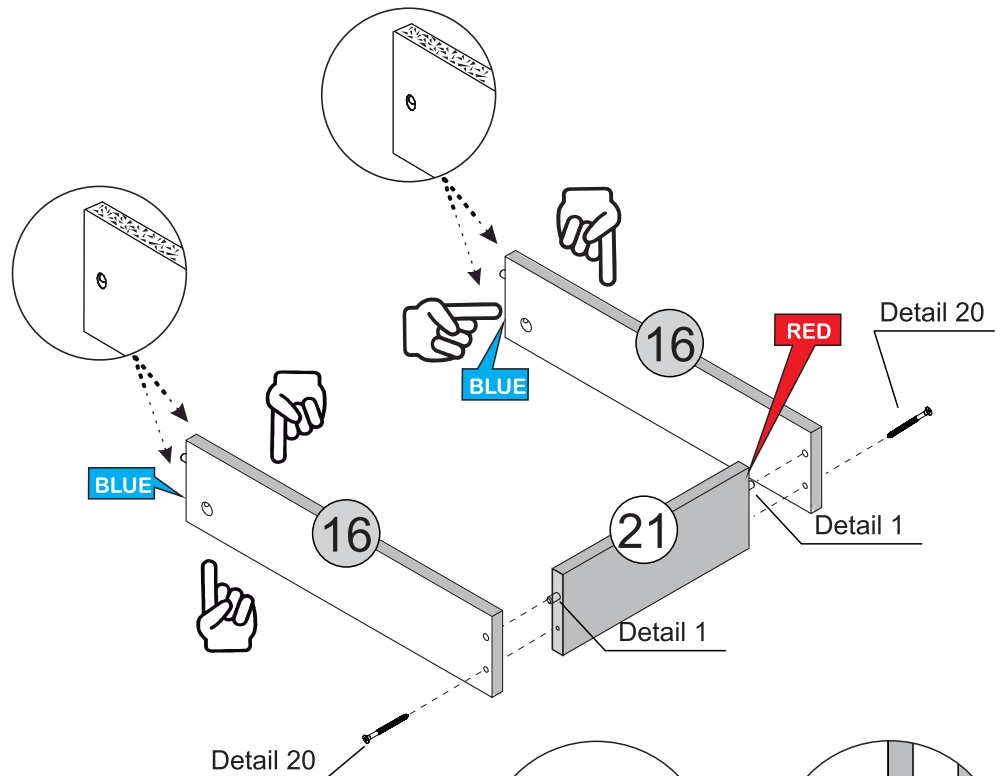

Detail 1

Detail 20

STEP 30

PARTS REQUIRED

22 - SMALL DRAWER FRONT x1

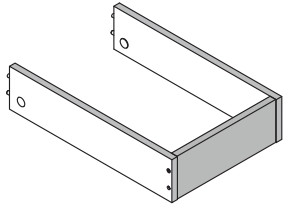

HARDWARE REQUIRED

H  01

TOOLS REQUIRED

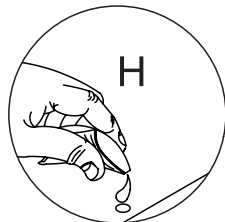

Detail 1

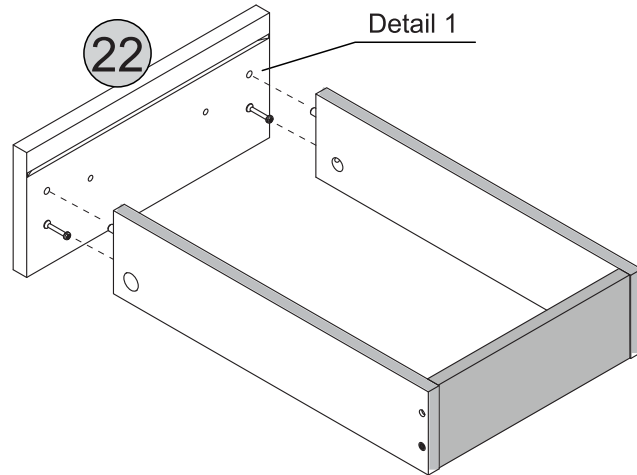

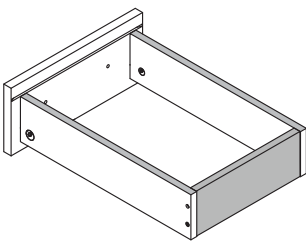

STEP 31

PARTS REQUIRED



HARDWARE REQUIRED

L  02

R  04

TOOLS REQUIRED

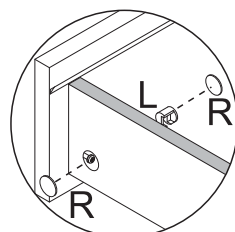
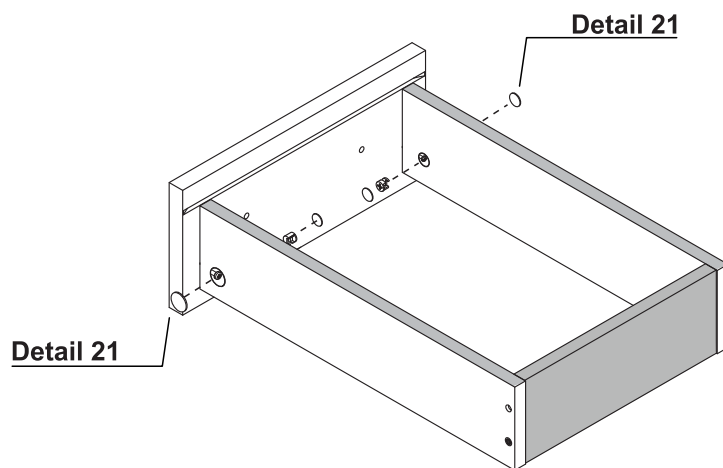
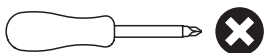

Detail 21

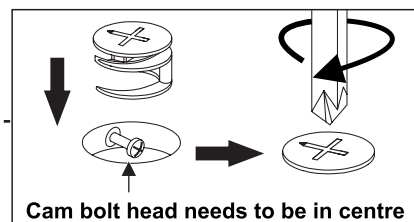

STEP 32

PARTS REQUIRED

23 - SMALL DRAWER BOTTOM x1

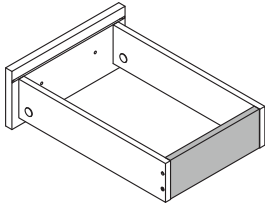

HARDWARE REQUIRED

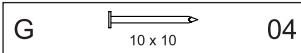

TOOLS REQUIRED

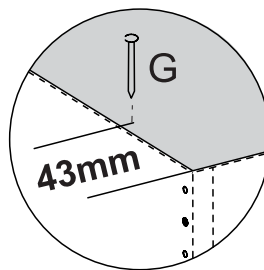
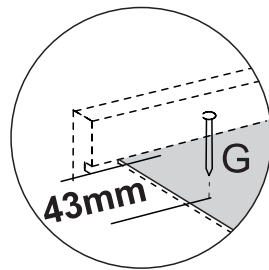
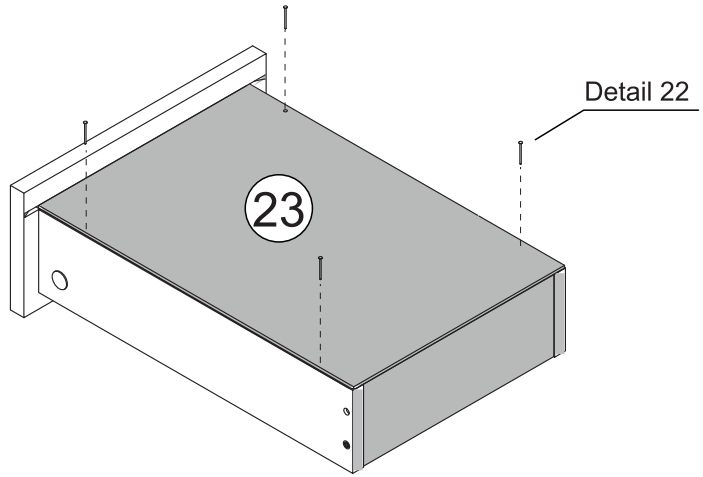
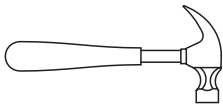

Detail 22

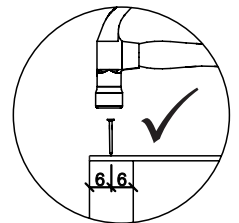
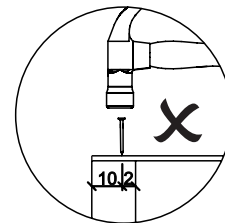
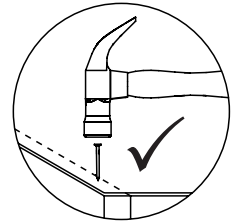
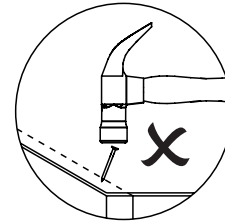

Detail 22

STEP 33

PARTS REQUIRED

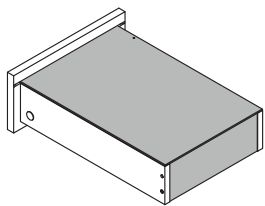

HARDWARE REQUIRED

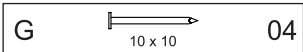

TOOLS REQUIRED

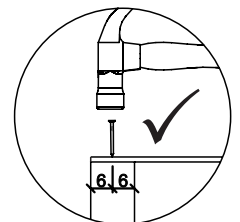
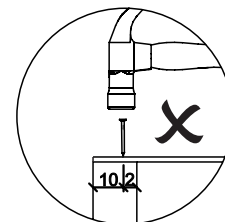
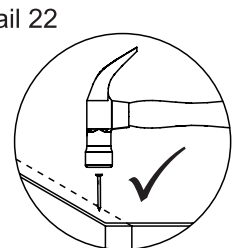
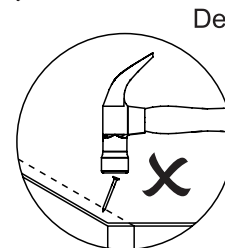
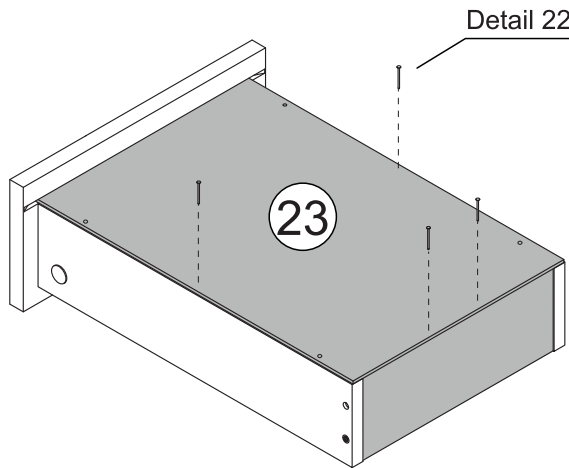
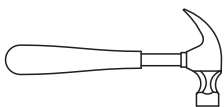

Detail 22

STEP 34

PARTS REQUIRED

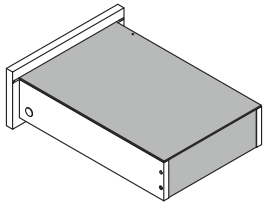

HARDWARE REQUIRED

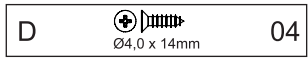

TOOLS REQUIRED

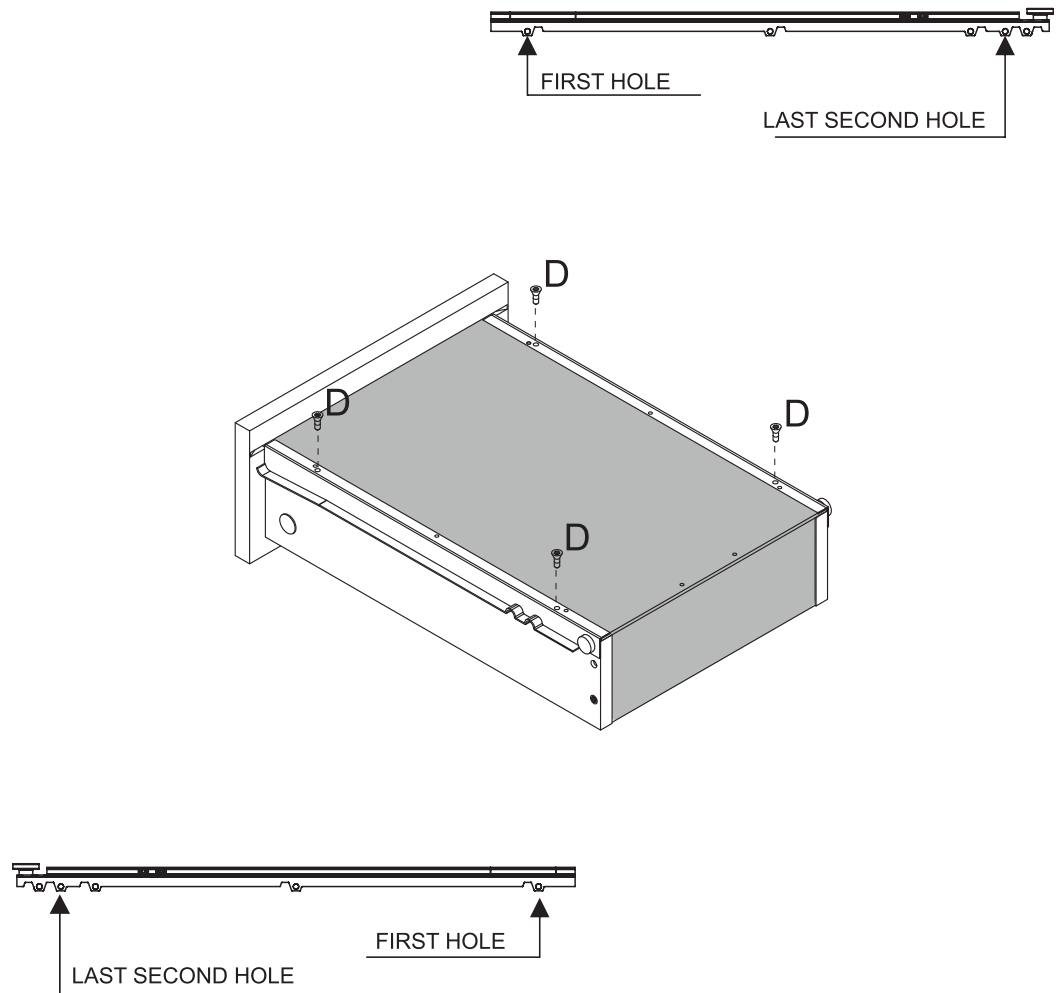

STEP 35

PARTS REQUIRED



HARDWARE REQUIRED

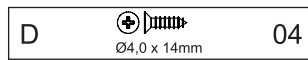

TOOLS REQUIRED

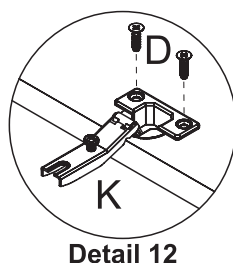
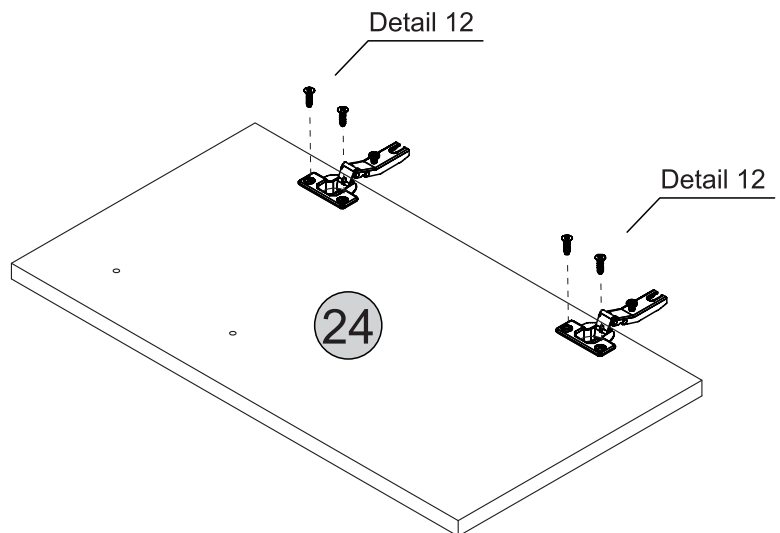
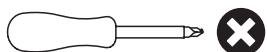

STEP 36

PARTS REQUIRED

24 - DOOR x1

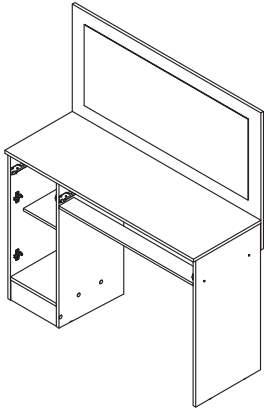

HARDWARE REQUIRED

R  12

TOOLS REQUIRED

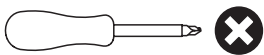

Detail 23

24

Detail 24

Detail 24

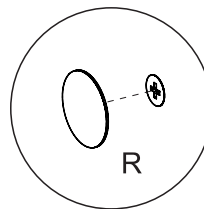
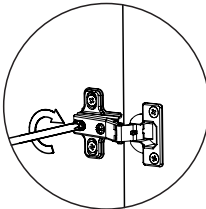
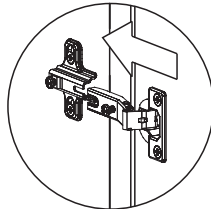

Detail 23

Detail 24

STEP 37

PARTS REQUIRED

12 - STOOL SIDE PANEL (GREEN) x2

HARDWARE REQUIRED

G  04

H  01

N  04
Ø6,0 x 30mm

P  04

TOOLS REQUIRED

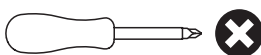
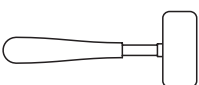

Detail 1

X2

12

Detail 4

GREEN

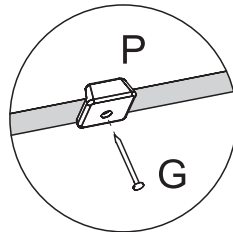

Detail 1

Detail 4

STEP 38

PARTS REQUIRED

13 - STOOL CROSSPIECE (YELLOW) x2

14 - STOOL SEAT x1

HARDWARE REQUIRED

H  01

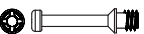
M  04

N  Ø6,0 x 30mm 04

TOOLS REQUIRED

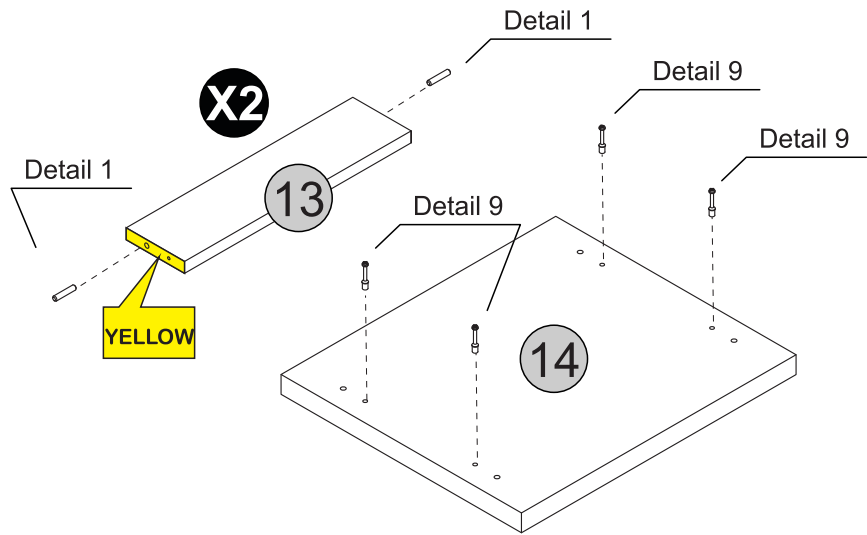
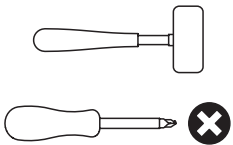

Detail 1

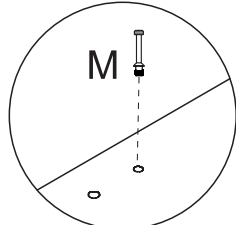

Detail 9

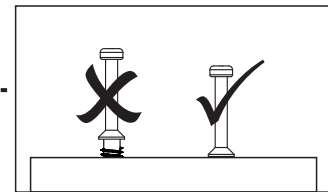

STEP 39

PARTS REQUIRED

12 - STOOL SIDE PANEL (GREEN) x2

13 - STOOL CROSSPIECE (YELLOW) x2

HARDWARE REQUIRED

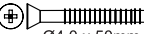
B  Ø4,0 x 50mm 04

H  01

R  04

TOOLS REQUIRED

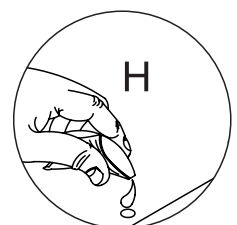
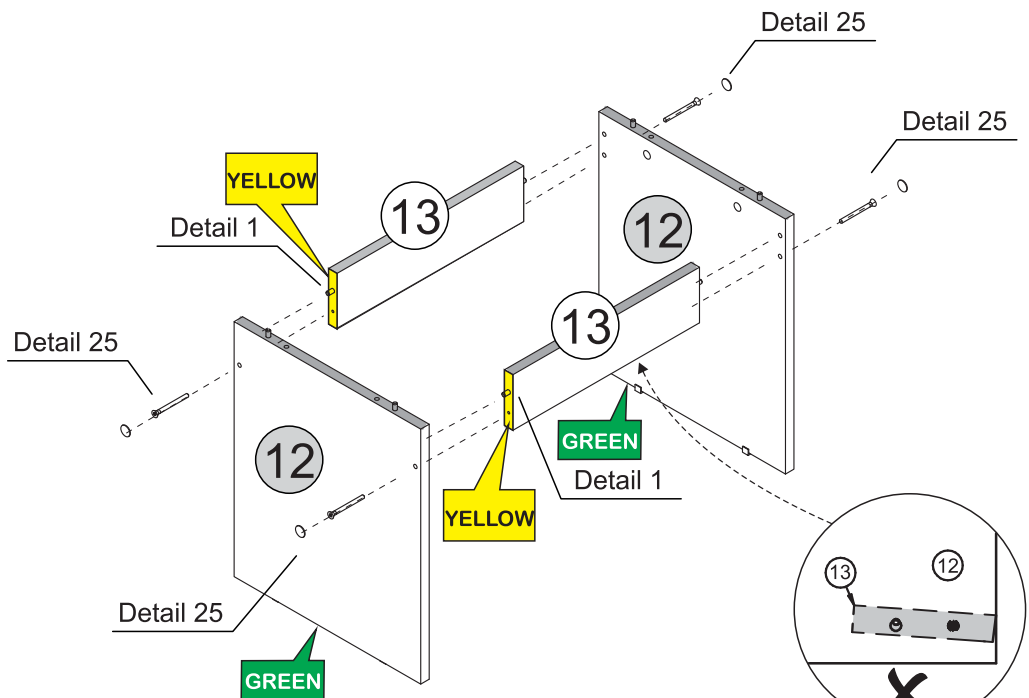

Detail 1

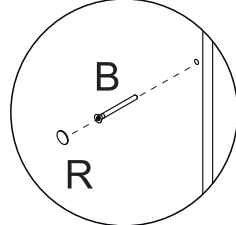

Detail 25

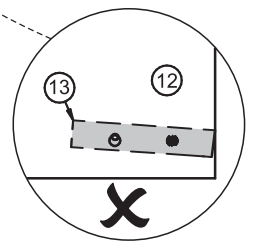

STEP 40

PARTS REQUIRED

14 - STOOL SEAT x1

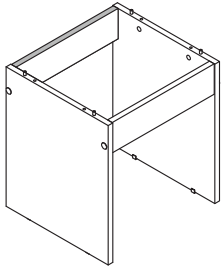

HARDWARE REQUIRED

H  01

L  04

TOOLS REQUIRED

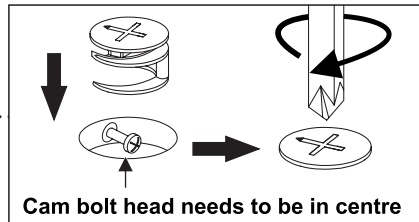
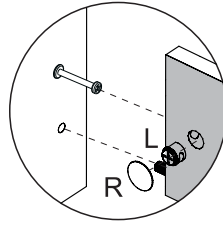
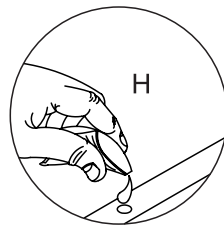
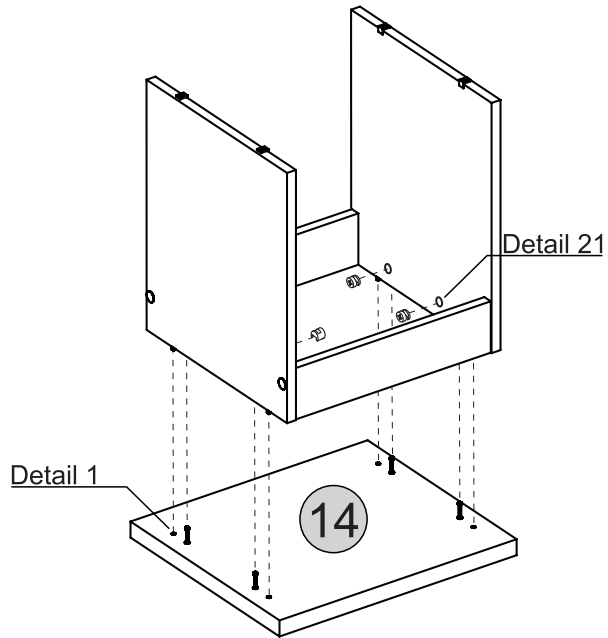
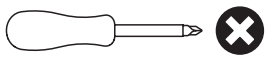

Detail 1

Detail 21

STEP 41

PARTS REQUIRED

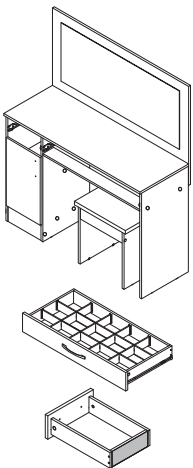

HARDWARE REQUIRED

E  04
MQ M4 x 20mm

Q  02

TOOLS REQUIRED

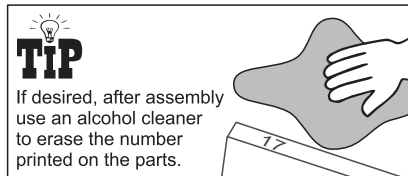
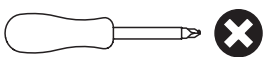

 See the last page

Detail 25

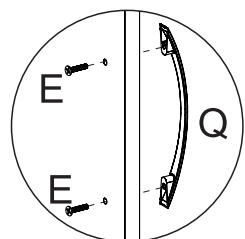

Detail 25

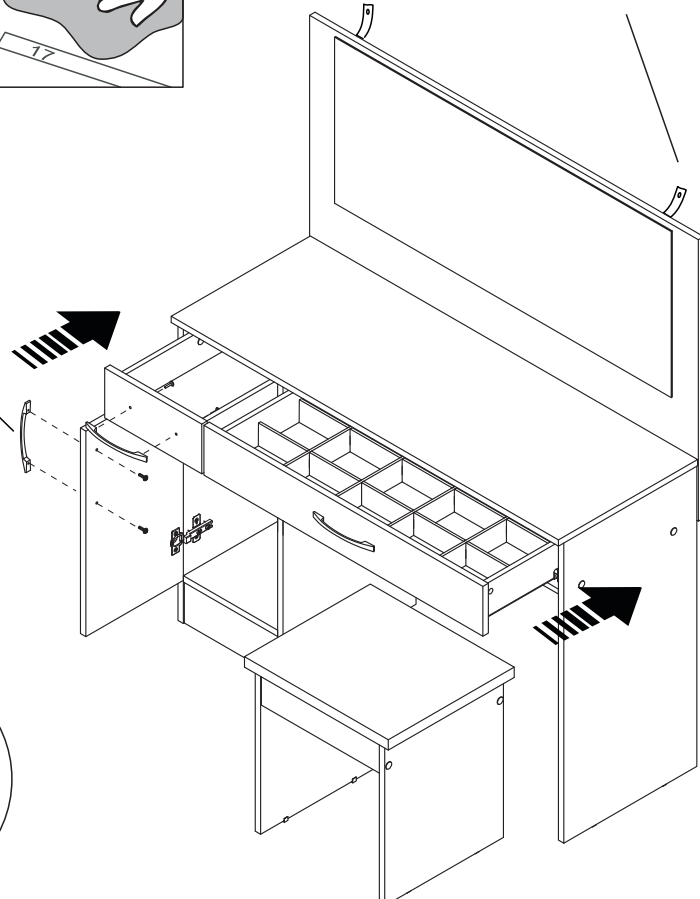

STEP 42

PARTS REQUIRED

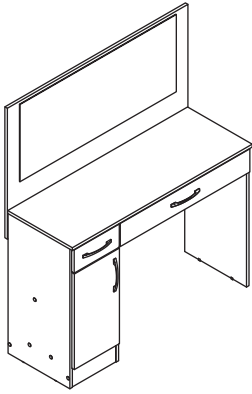

HARDWARE REQUIRED

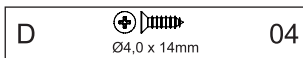

TOOLS REQUIRED

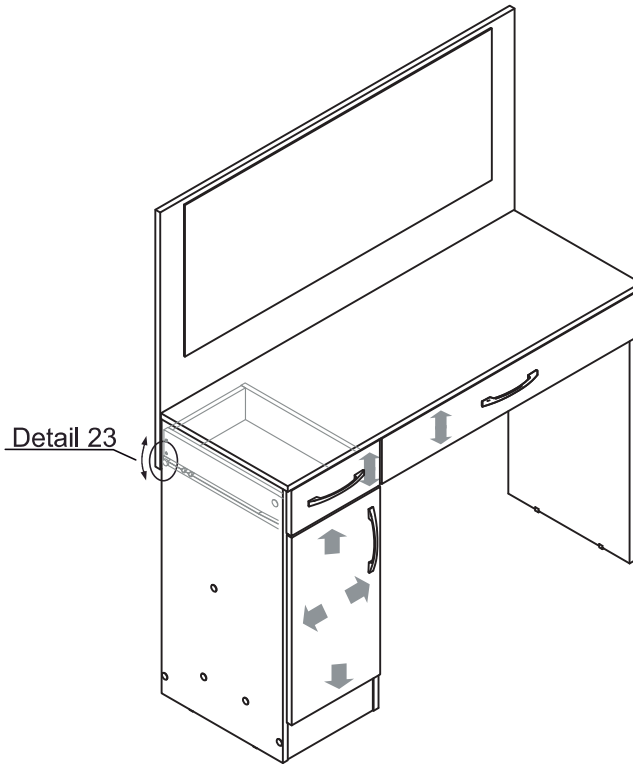
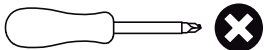

Drawer Adjustment

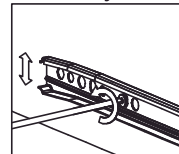

Drawer Lock

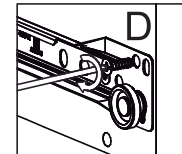

Detail 23

Height Adjustment

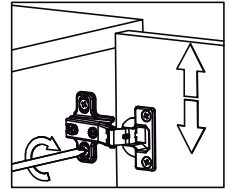

Internal Adjustment

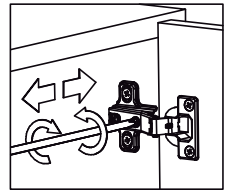

Depth Adjustment

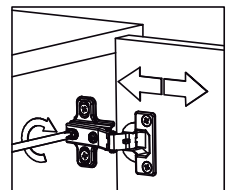
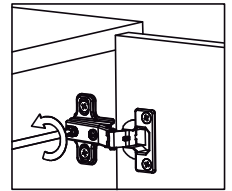





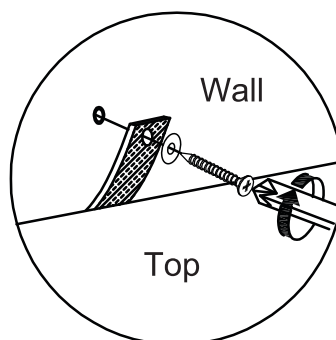
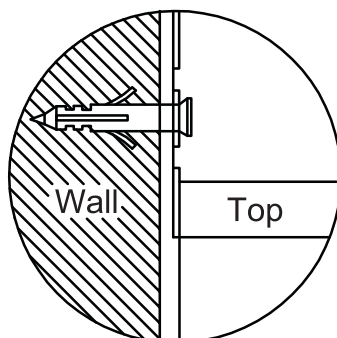
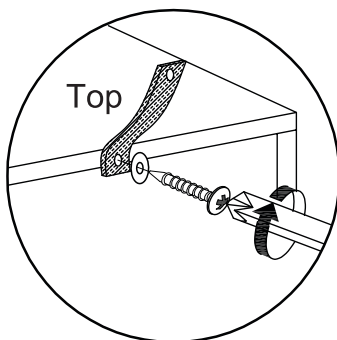

WARNING

Serious or fatal injuries can occur from furniture tipping over. To prevent the furniture from tipping over we recommend that it is permanently fixed to the wall.

Wall fixings are not supplied with this product as different wall materials require different types of fixing devices.

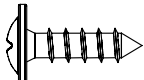
Please make sure you use fixings suitable for the walls in your home.



	
A	Flan Head Screw Ø4,0 x 14mm (2x)
	
S	Washer (4x)
	
O	Strap (2x)