

BLACK PU WAVERLEY 3' STORAGE BED ASSEMBLY INSTRUCTIONS

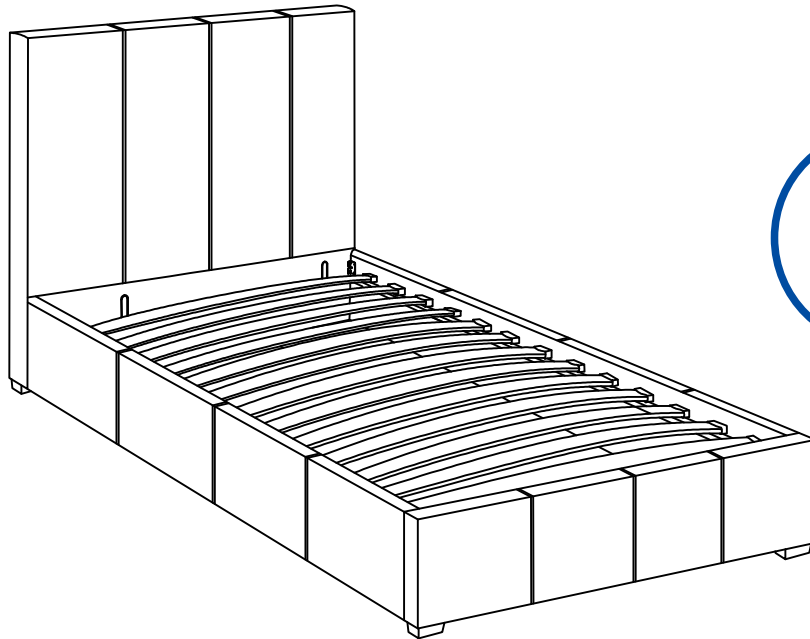

FOR DOMESTIC USE ONLY **IMPORTANT**

PLEASE READ BEFORE YOU CONTINUE FURTHER

THE PRODUCT YOU HAVE PURCHASED WILL GIVE YOU MANY YEARS OF SERVICE IF YOU FOLLOW THE GUIDELINES FOR ITS SAFE ASSEMBLY AND PERIODIC MAINTENANCE AND CLEANING.

ASSEMBLE ON A SOFT CLEAN SURFACE.

DO NOT USE ANY TOOLS OTHER THAN THOSE SHOWN.

ANY SPANNERS OR ALLEN KEYS REQUIRED ARE INCLUDED WITH THE FITTINGS KIT.

DO NOT FOR ANY REASON USE A POWER TOOL TO ASSEMBLE THIS PRODUCT. ITS USE WILL INVALIDATE ANY CLAIM YOU MAY HAVE AND COULD MAKE THIS PRODUCT UNSAFE.

DEPENDING ON THE AMOUNT OF USE THIS PRODUCT RECEIVES IT MAY BE NECESSARY TO TIGHTEN UP THE FIXINGS FROM TIME TO TIME. THIS IS COMPLETELY NORMAL FOR ANY FLAT PACK FURNITURE.

DO NOT OVERTIGHTEN FIXINGS.

FOR CLEANING, YOU MAY USE A DAMP CLOTH (NOT WET) DO NOT USE POLISH, DETERGENT OR CHEMICAL CLEANERS

THIS PRODUCT MAY STAIN OR MARK IF ALLOWED TO COME INTO CONTACT WITH WET OR DAMP OBJECTS AS MATERIALS USED HAVE NOT BEEN SCOTCH GUARDED.

THE SURFACE OF THIS ITEM IS NOT HEAT RESISTANT. ALWAYS USE A PLACE MAT UNDER HOT OR COLD ITEMS TO PREVENT MARKING.

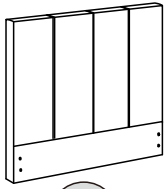
PART LIST

1

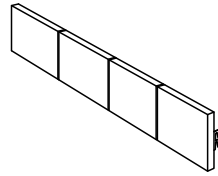

2

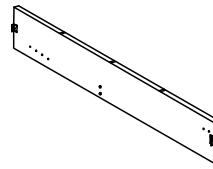

3

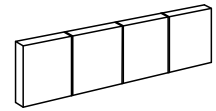

4

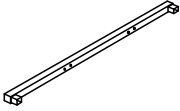

5

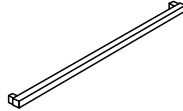

6

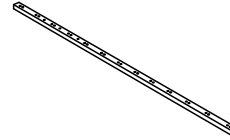

7

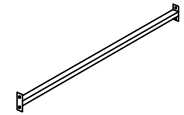

8

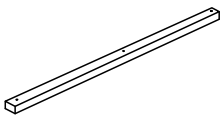

9



10

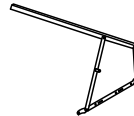

11



12



13



14

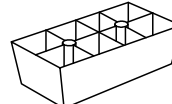

15

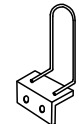

16

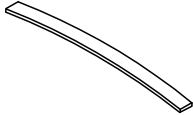

17

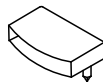









18

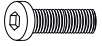

19

Part Number	Part Code	Part Description	Quantity	Carton
1	S200-201-036-HA1-01	Headboard	1	1/2
2	S200-201-036-HA1-02	Footboard	1	2/2
3	S200-201-036-HA1-03	Left Side Rail	1	2/2
4	S200-201-036-HA1-04	Right Side Rail	1	2/2
5	S200-201-036-HA1-05	Front Frame Rail	1	2/2
6	S200-201-036-HA1-06	Back Frame Rail	1	2/2
7	S200-201-036-HA1-07	Front Side Rail	2	2/2
8	S200-201-036-HA1-08	Centre Frame Rail	1	2/2
9	S200-201-036-HA1-09	Crossrail	1	2/2
10	S200-201-036-HA1-10	Strap	1	2/2
11	S200-201-036-HA1-11	Left Lifting Arm	1	2/2
12	S200-201-036-HA1-12	Right Lifting Arm	1	2/2
13	S200-201-036-HA1-13	Gas Lift	2	2/2
14	S200-201-036-HA1-14	Corner Bracket	2	2/2
15	S200-201-036-HA1-15	Feet	4	2/2
16	S200-201-036-HA1-16	Mattress Support	2	2/2
17	S200-201-036-HA1-17	Sprung Slats	13	1/2
18	S200-201-036-HA1-18	Plastic Slat Caps	26	2/2
19	S200-201-036-HA1-19	Woven Fabric	1	1/2

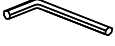
HARDWARE LIST

REF		HARDWARE NAME	QTY
A		5/16x2" BOLT	2 PCS
B		5/16x1" BOLT	8 PCS
C		5/16x3/4" BOLT	4 PCS
D		1/4x3/4" BOLT	30 PCS
E		5/16"x19mm FLAT WASHER	44 PCS
F		5/16"x13mm SPRING WASHER	26 PCS
G		5/16"x12mm	6 PCS
H		#7*1-1/2 Screw	8 PCS
I		M4 ALLEN KEY	1 PC
J		M5 ALLEN KEY	1 PC
K		12mm SPANNER	1 PC

PLEASE CHECK THAT YOU HAVE ALL THE PARTS LISTED BEFORE YOU START ASSEMBLING. IF YOU DO FIND THAT SOMETHING IS MISSING, DO NOT CONTINUE ASSEMBLY. PLEASE CONTACT YOUR SUPPLIER IMMEDIATELY.

Important information!

The gas lifts used in the construction of this product are extremely strong and cannot be operated by hand when not fitted to the ottoman hinges. All gas lifts are tested in the factory for correct pressure and operation before use.

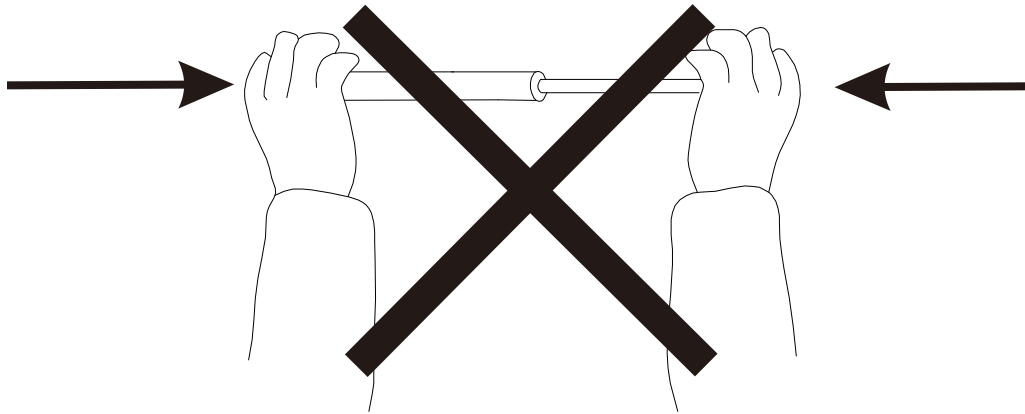

You must ensure the **MATTRESS** is on the bed frame before lifting the mechanism.

FAILURE TO DO SO MAY RESULT IN INJURY.

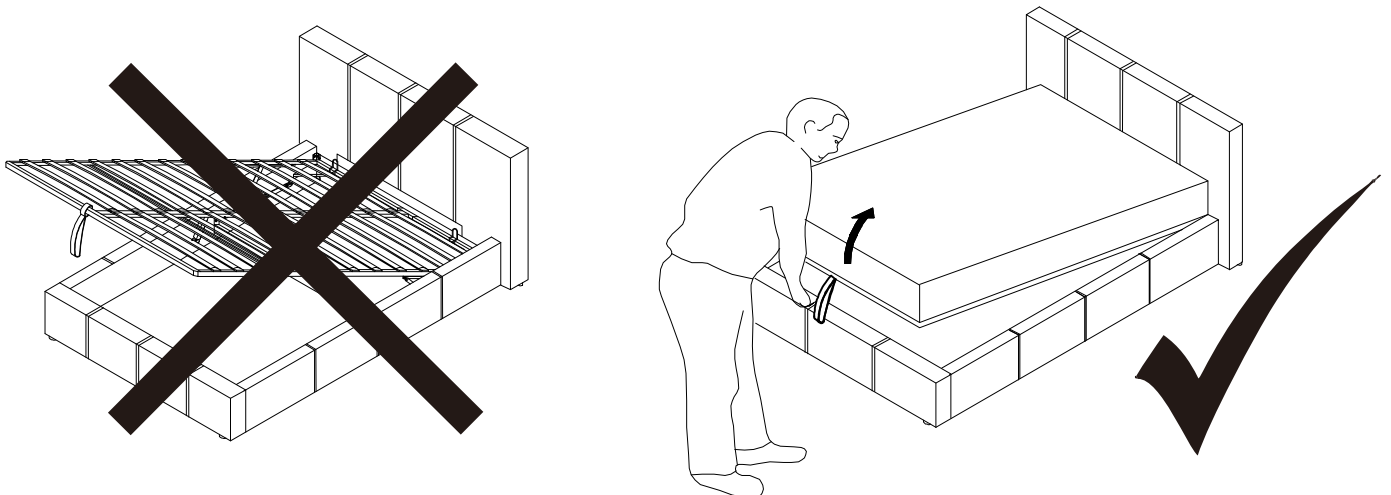

Initially it might appear that the gas lifts are very stiff when opening and closing the ottoman frame, **THIS IS NORMAL.**

After operating the ottoman a few times, the movement of the gas lifts and the opening and closing of the ottoman will become easier.

STEP 1

PARTS REQUIRED

1 - HEADBOARD	x1
15 - FEET	x2

HARDWARE REQUIRED

H		04
---	---	----

TOOLS REQUIRED

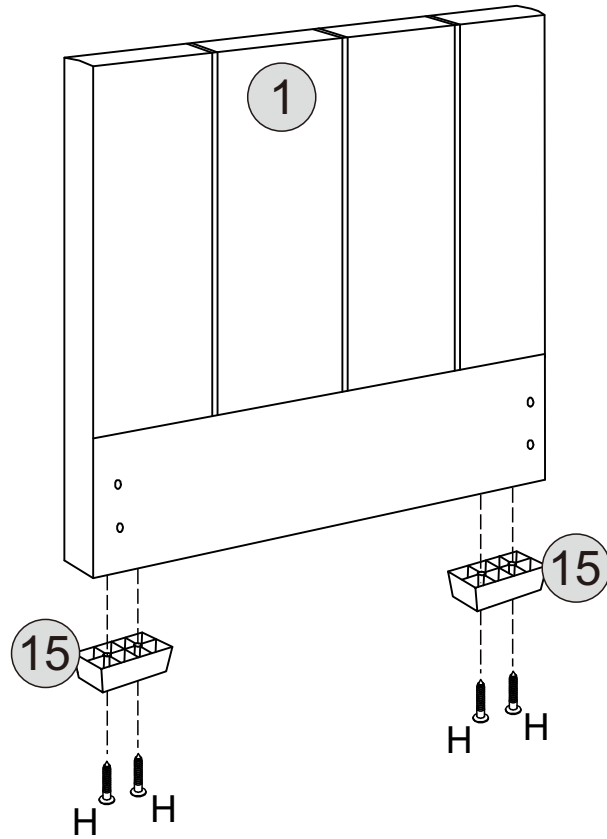
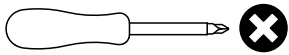

STEP 2

PARTS REQUIRED

2 - FOOTBOARD	x1
15 - FEET	x2

HARDWARE REQUIRED

H		04
---	---	----

TOOLS REQUIRED

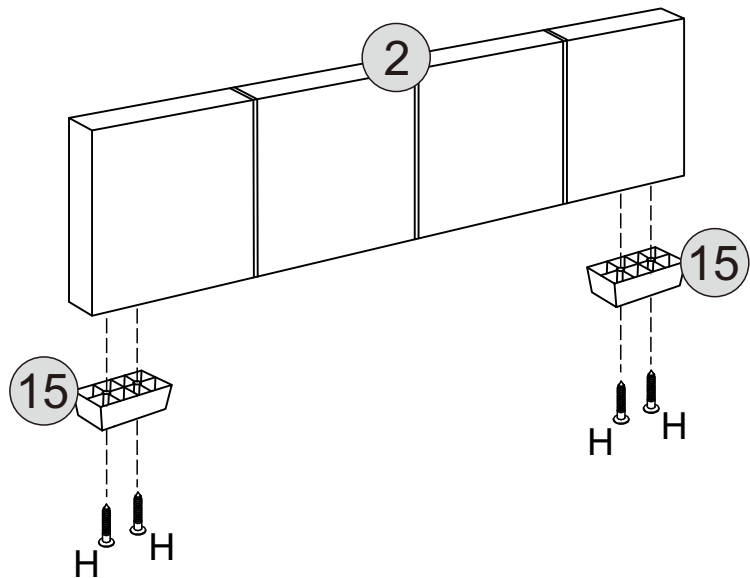
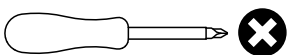



STEP 3

PARTS REQUIRED

1 - HEADBOARD	x1
2 - FOOTBOARD	x1
3 - LEFT SIDERAIL	x1
4 - RIGHT SIDERAIL	x1

HARDWARE REQUIRED

B		08
E		08
F		08

TOOLS REQUIRED

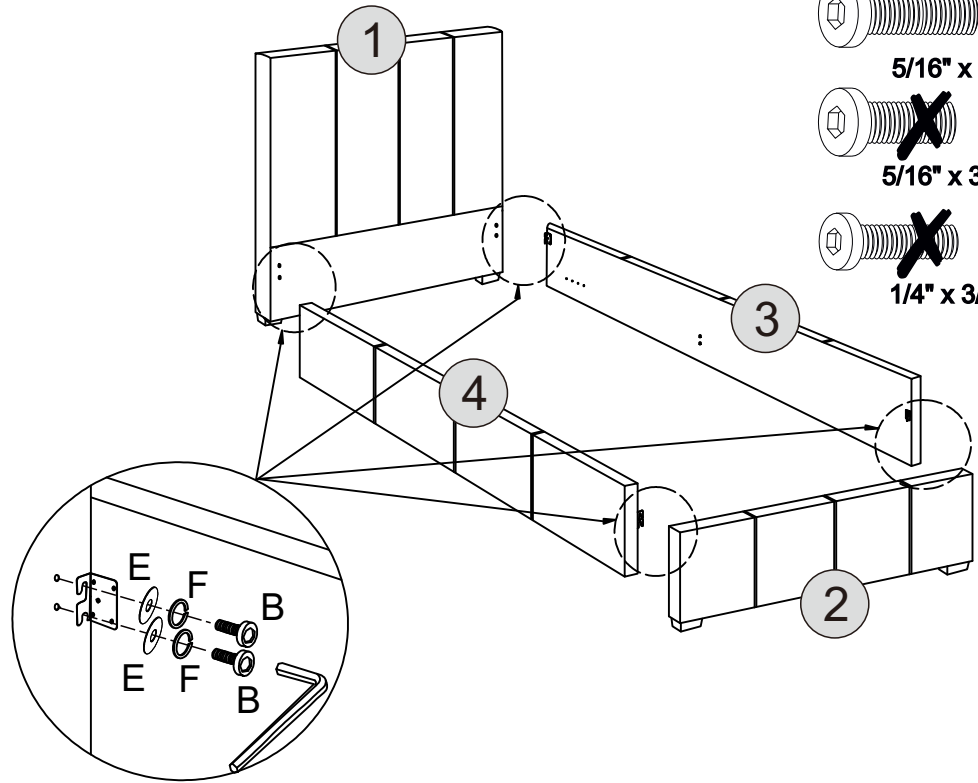
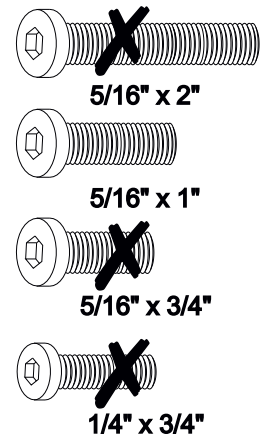
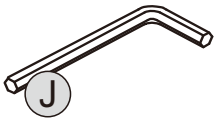



STEP 4

PARTS REQUIRED

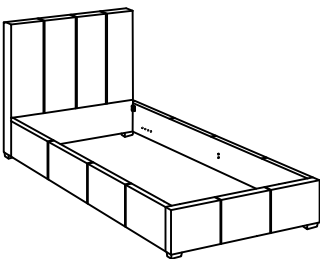
14 - CORNER BRACKET	x2
---------------------	----



HARDWARE REQUIRED

D		08
E		08

TOOLS REQUIRED

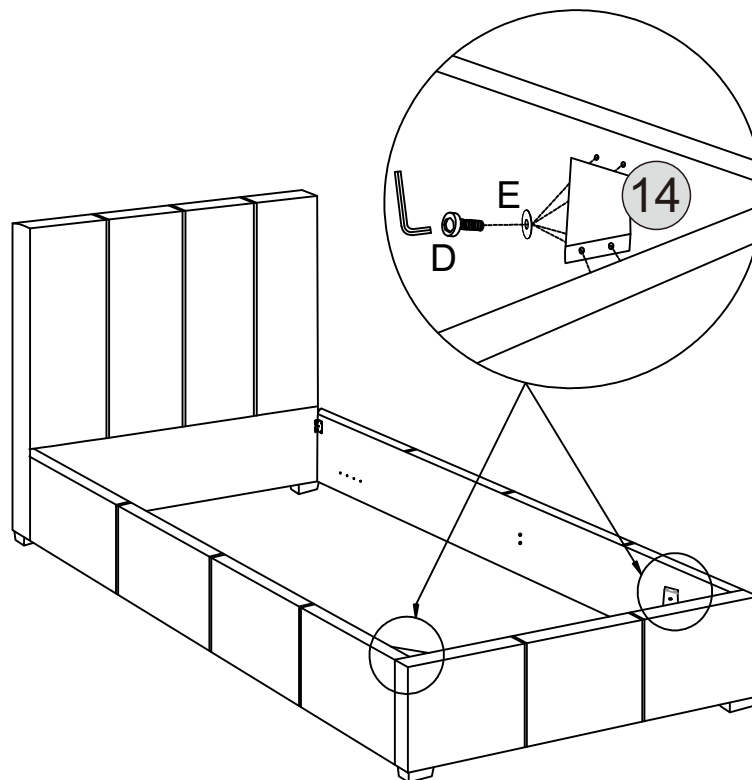
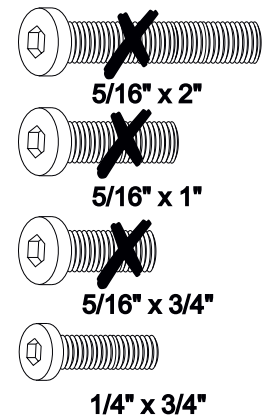

STEP 5

PARTS REQUIRED

5 - FRONT FRAME RAIL x1

6 - BACK FRAME RAIL x1

7 - FRONT SIDE RAIL x2

10 - STRAP x1

HARDWARE REQUIRED

C  04
5/16" x 3/4"

E  04

F  04

TOOLS REQUIRED

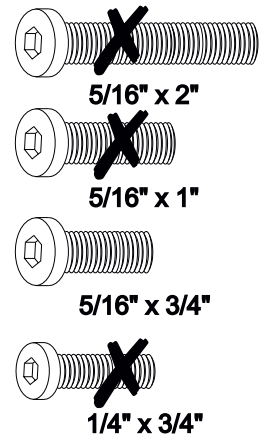
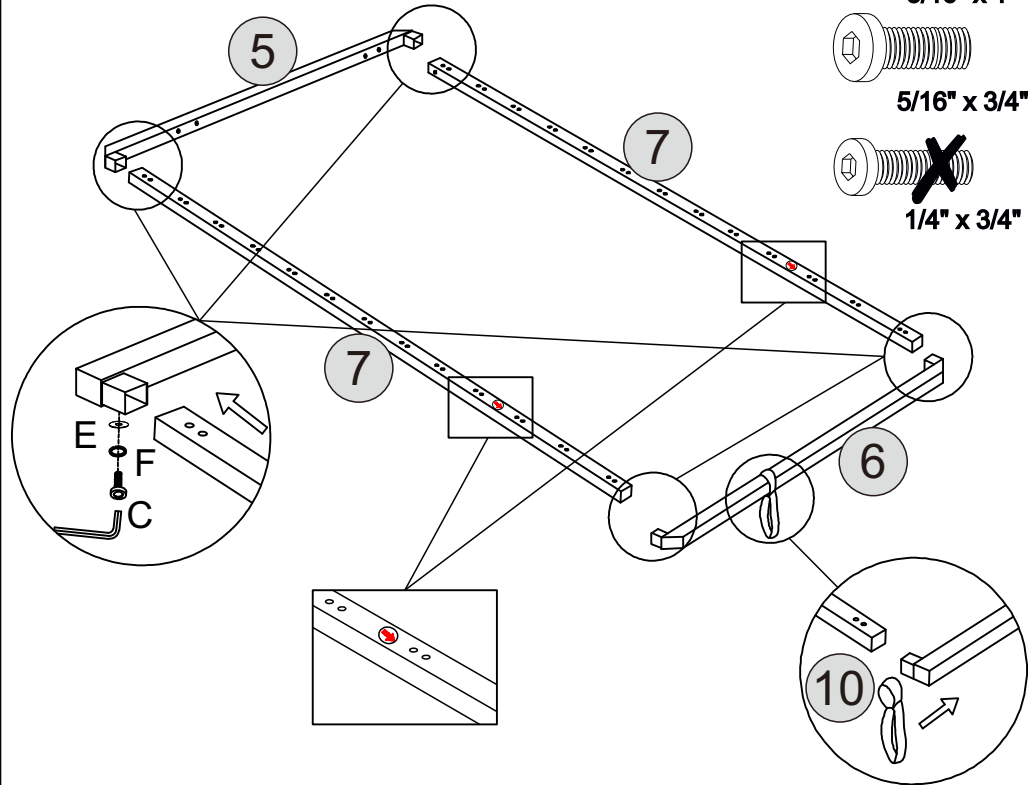
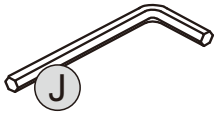

STEP 6

PARTS REQUIRED

9 - CROSSRAIL x1

16 - MATTRESS SUPPORT x2

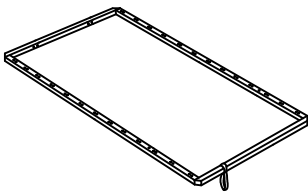

HARDWARE REQUIRED

A  02
5/16" x 2"

D  04
1/4" x 3/4"

E  06

F  06

G  02

TOOLS REQUIRED

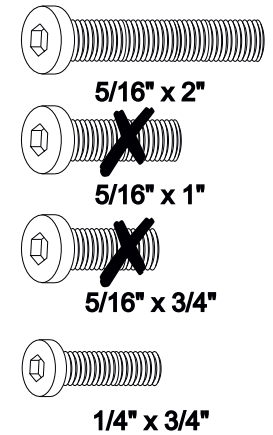
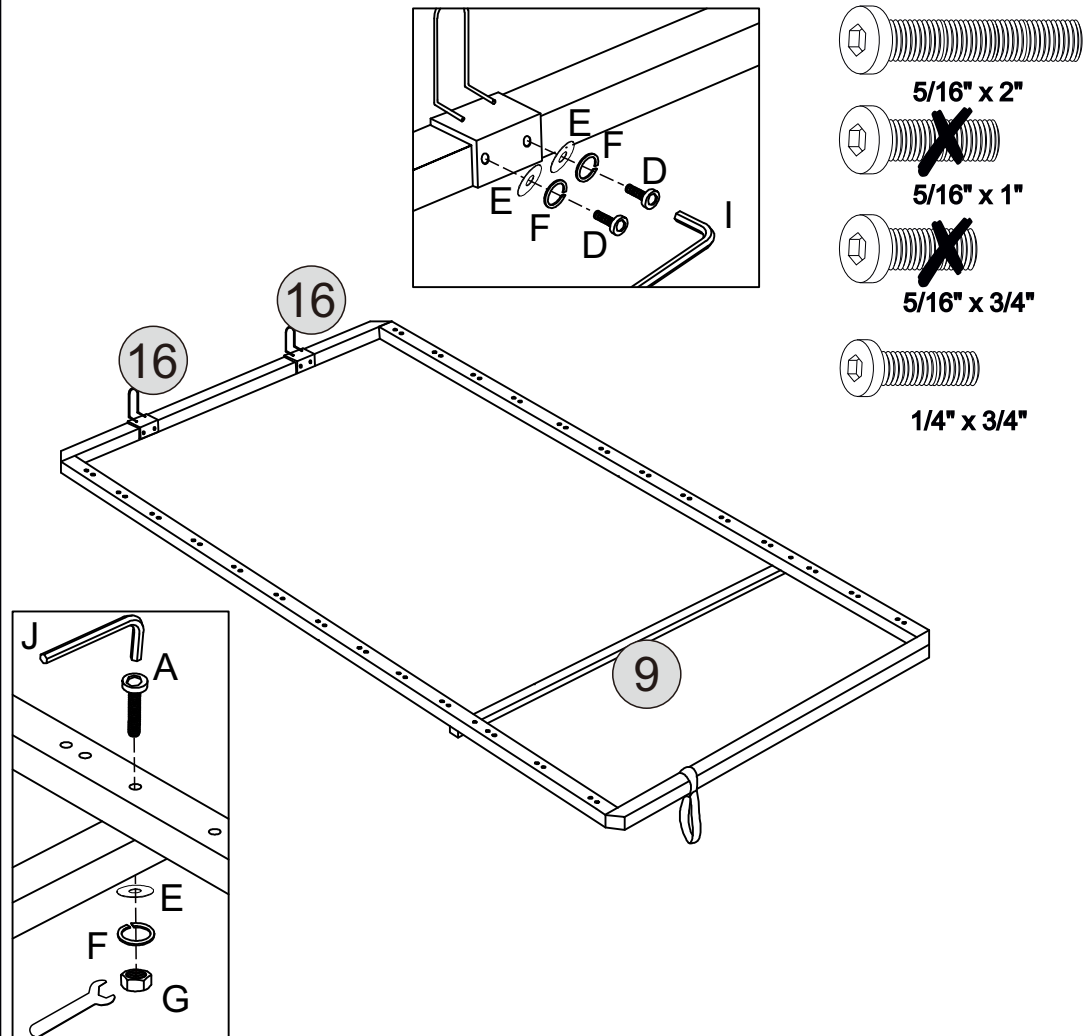
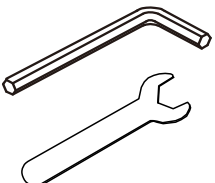

STEP 7

PARTS REQUIRED

11 - LEFT LIFTING ARM	x1
12 - RIGHT LIFTING ARM	x1
13 - GAS LIFT	x2

HARDWARE REQUIRED

G		04
---	---	----

TOOLS REQUIRED

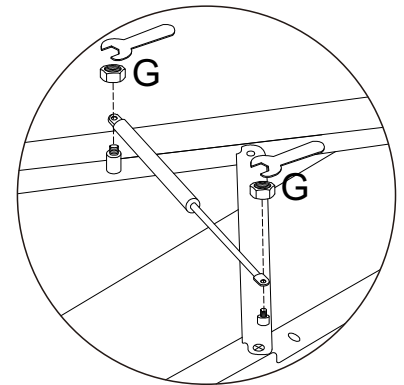
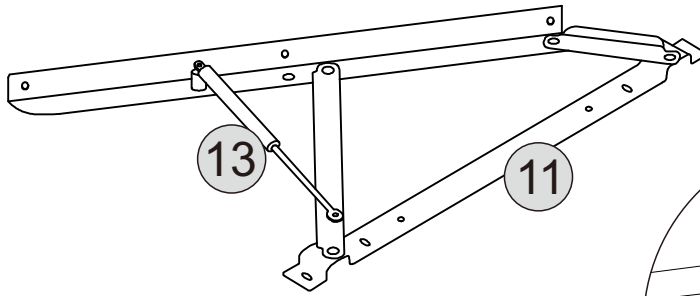
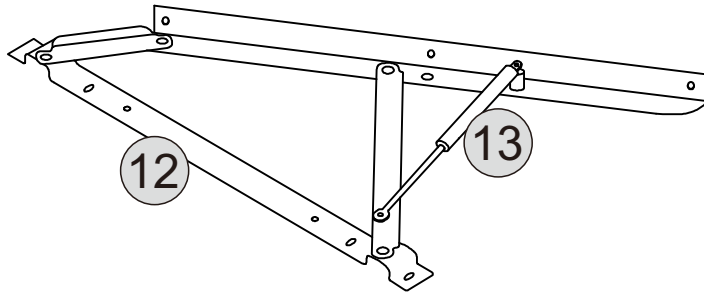
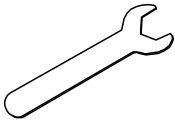



STEP 8

PARTS REQUIRED

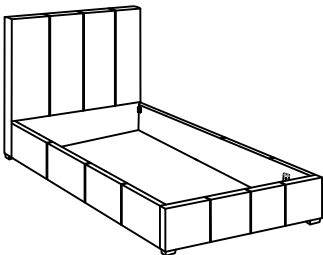
8 - CENTRE FRAME RAIL	x1
11 - LEFT LIFTING ARM	x1
12 - RIGHT LIFTING ARM	x1



HARDWARE REQUIRED

D		12
E		12
F		08

TOOLS REQUIRED

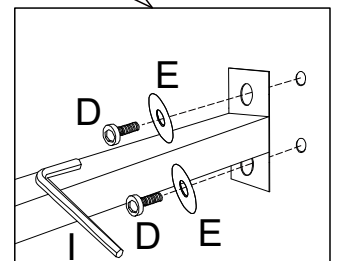
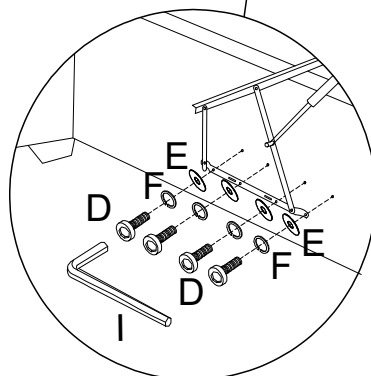
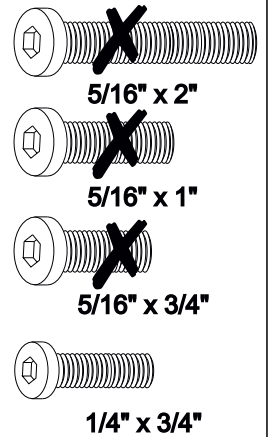
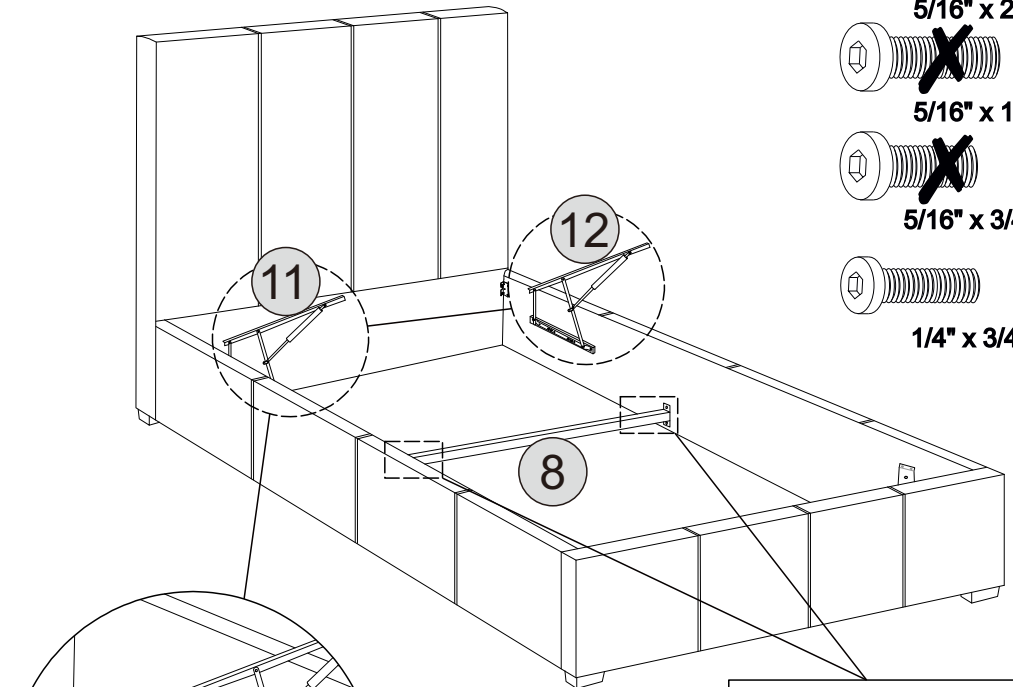

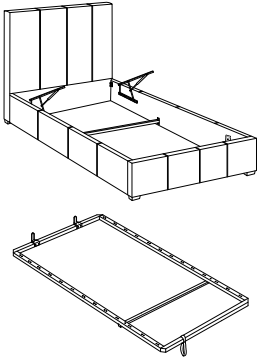

STEP 9

PARTS REQUIRED



HARDWARE REQUIRED

D		06
E		06

TOOLS REQUIRED

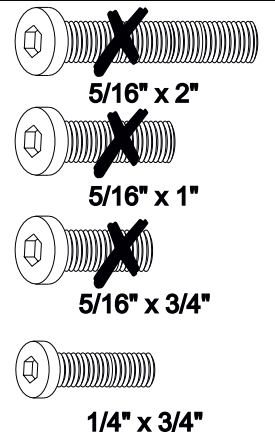
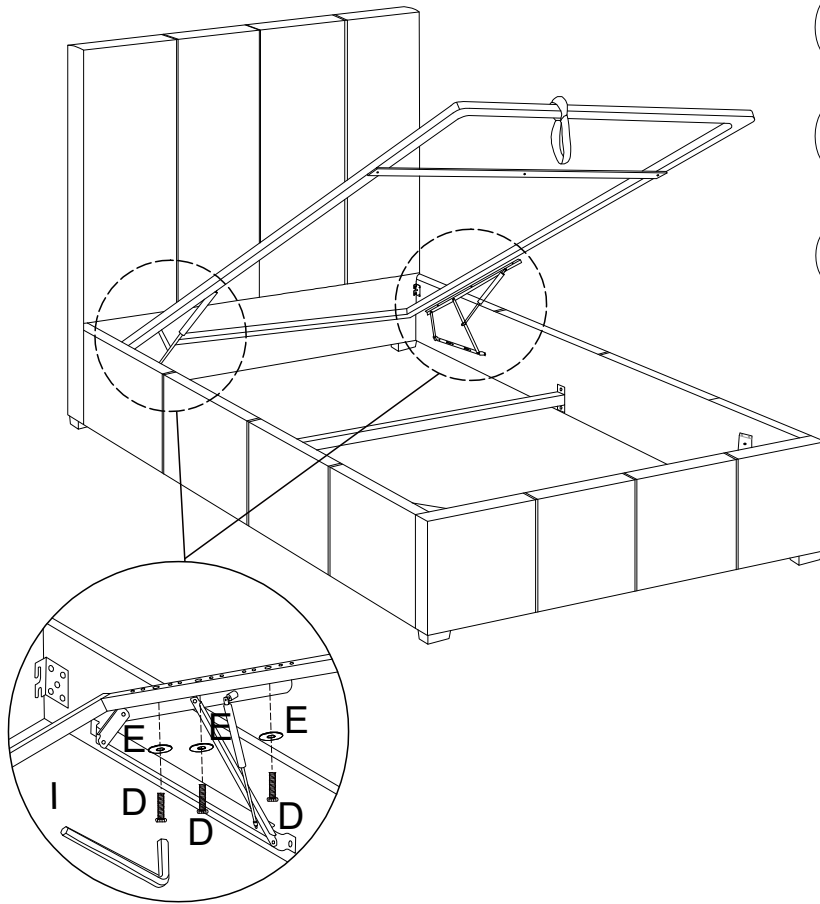
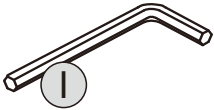

STEP 10

PARTS REQUIRED

19 - WOVEN FABRIC	x1
-------------------	----

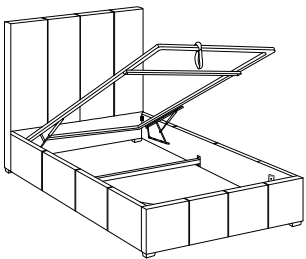

HARDWARE REQUIRED

TOOLS REQUIRED

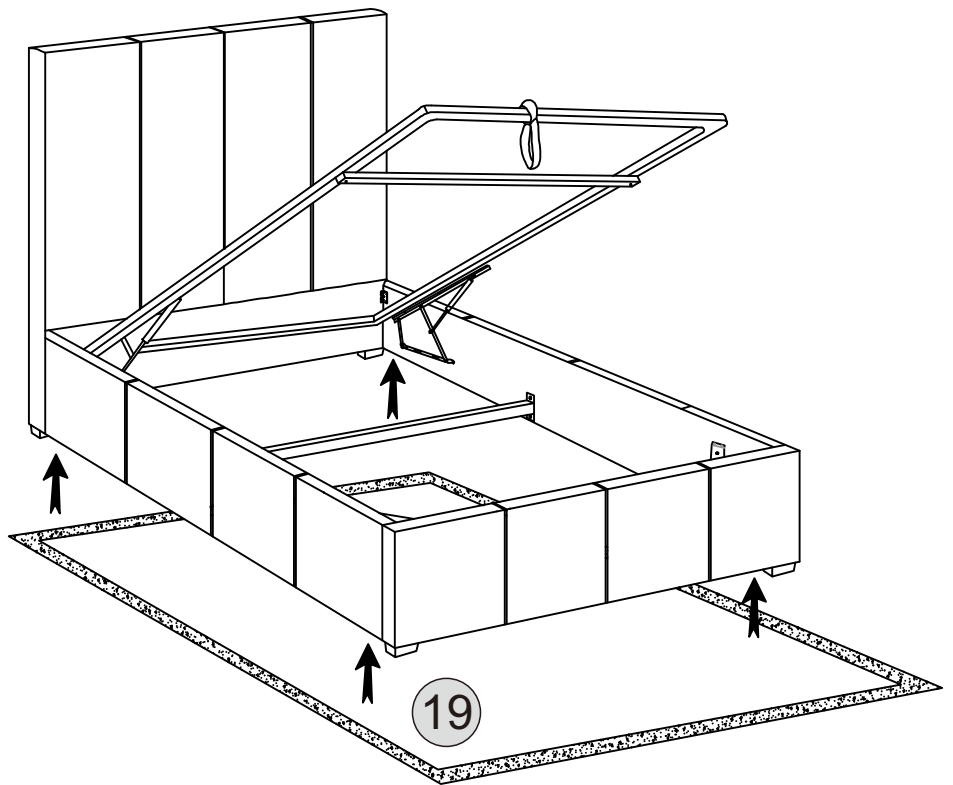

STEP 11

PARTS REQUIRED

17 - SPRUNG SLATS x13

18 - PLASTIC SLAT CAPS x26

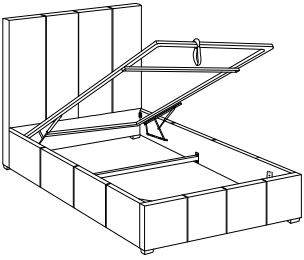

HARDWARE REQUIRED

TOOLS REQUIRED

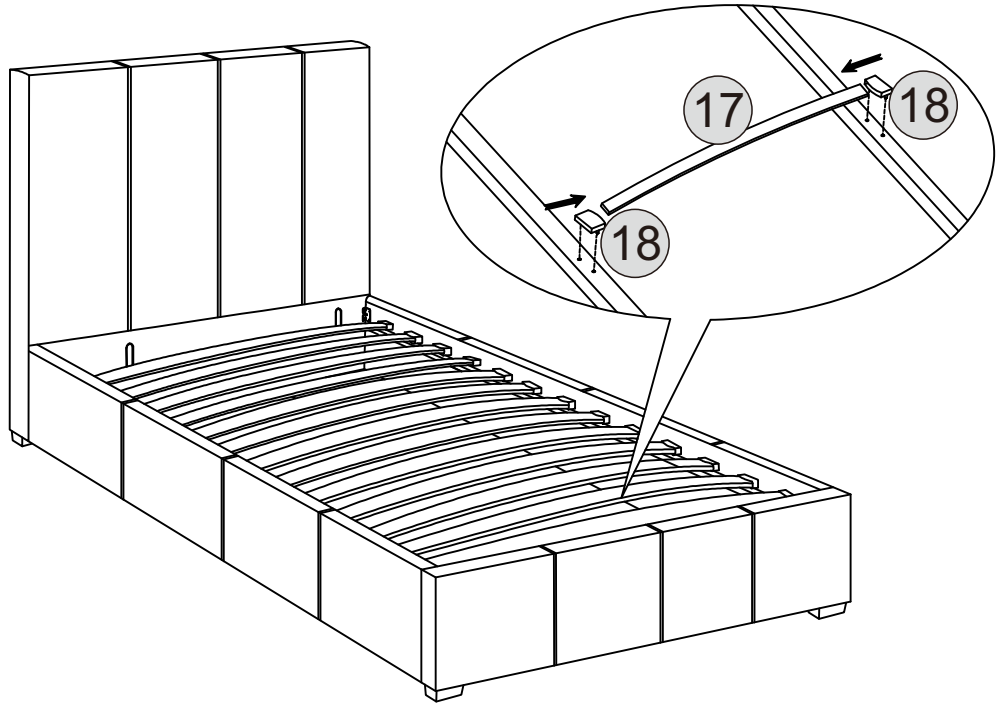

STEP 12

PARTS REQUIRED

HARDWARE REQUIRED

TOOLS REQUIRED

