

CODY 1 DRAWER HOUSE BED

ASSEMBLY INSTRUCTIONS

WHITE/PINE EFFECT

55770



**MAX BED
WEIGHT**

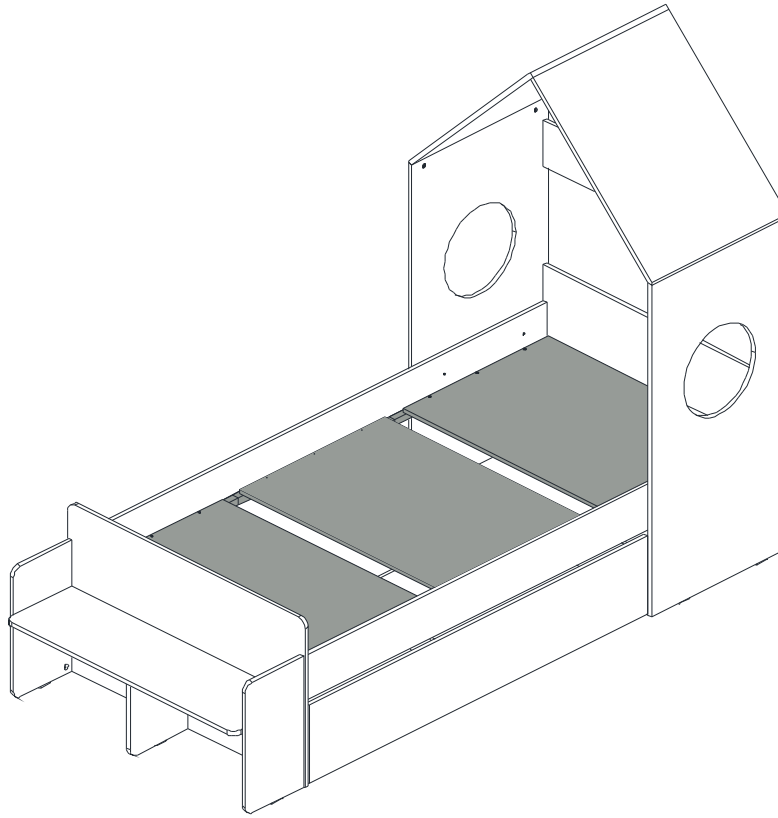

IMPORTANT FOR DOMESTIC USE ONLY

PLEASE READ BEFORE YOU CONTINUE FURTHER

CARE AND MAINTENANCE

After unpacking this product please keep the original packaging in case it needs to be returned for any reason.

- Please ensure all fittings and parts are present before commencing with assembly.
- Never drag or push products as this could cause damage to the joints making it inferior.
- We strongly recommend that you keep children away from your work area.
- We recommend that you lay a blanket or sheet on the floor to avoid damage to both your floor and the product.
- Assemble this product as close to its final position as possible.
- Do not place this product next to a radiator or in direct sunlight.
- Do not drag or push items across your high gloss furniture as this may cause the surface to scratch
- Wood is a natural product and may expand if subjected to damp and may shrink or crack if subjected to heat. Therefore it is recommended that room temperature is maintained, with no sudden temperature fluctuations.
- Make sure any spillage is wiped off immediately.
- Do not place hot or chilled items directly on to the surface, use a place mat or marking will occur.
- For general cleaning use a soft cotton or micro fibre cloth, and do not use detergents of any kind.
- From time to time it may be necessary to tighten fittings, regular inspections should be carried out.
- Do not place on a wet or damp floor as staining may occur to your floor.

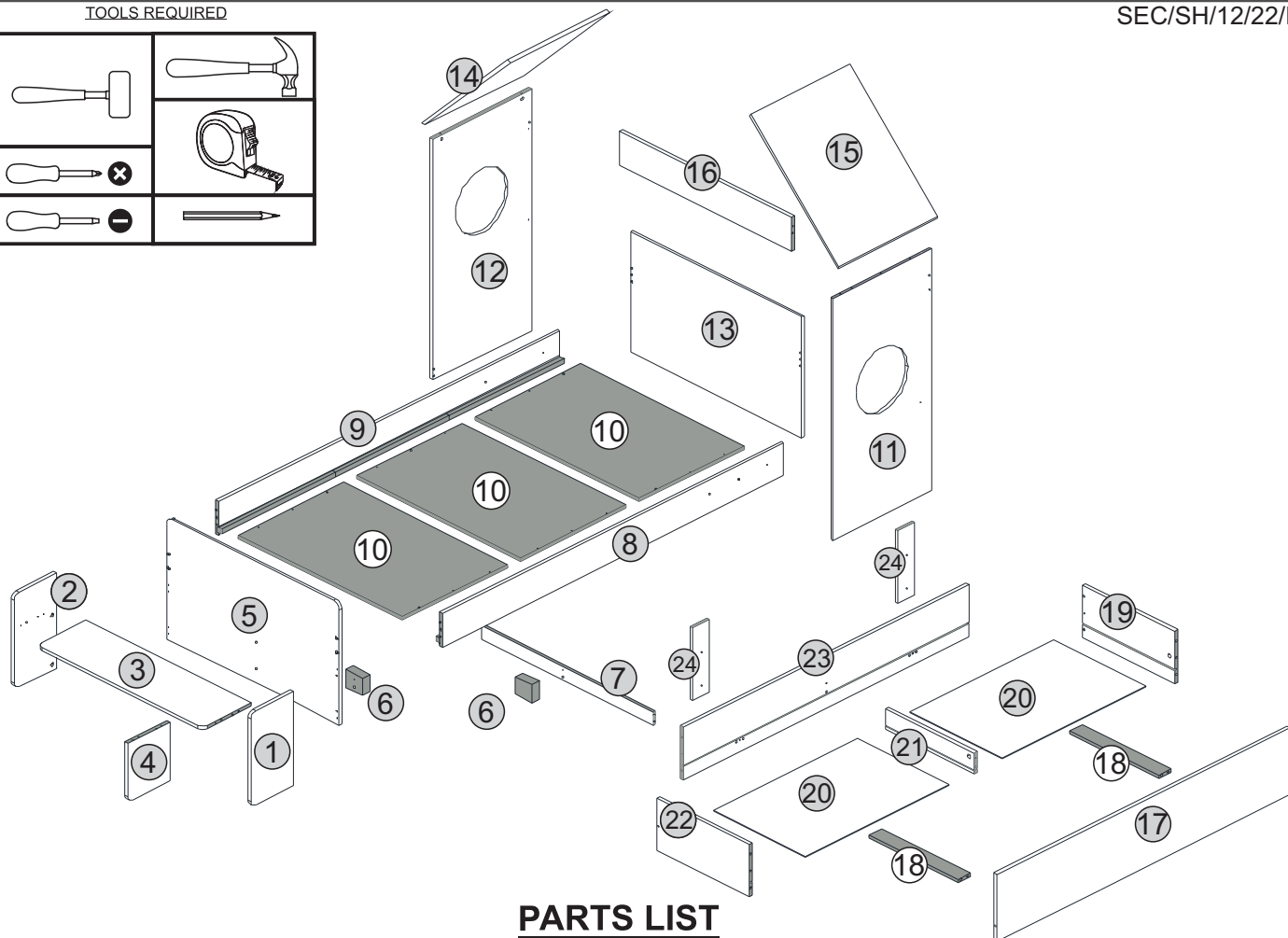
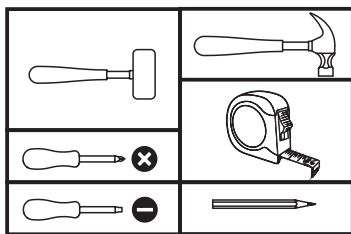













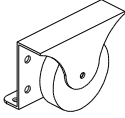



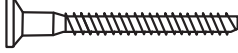

PARTS LIST

Please Note:
The below parts have all been stamped with the part number to help identify them during assembly.

Part Number	Part Code	Part Description	Quantity	Carton
1	S200-201-072-DV1-01	Right Side Of Seat	1	1/3
2	S200-201-072-DV1-02	Left Side Of Seat	1	1/3
3	S200-201-072-DV1-03	Seat Shelf	1	1/3
4	S200-201-072-DV1-04	Centre Divider	1	2/3
5	S200-201-072-DV1-05	Footboard	1	1/3
6	S200-201-072-DV1-06	Drawer Stop	2	3/3
7	S200-201-072-DV1-07	Lower Crossbar	1	3/3
8	S200-201-072-DV1-08	Right Side Rail	1	3/3
9	S200-201-072-DV1-09	Left Side Rail	1	3/3
10	S200-201-072-DV1-10	Mattress Base	3	1/3
11	S200-201-072-DV1-11	Right Side Of The House	1	2/3
12	S200-201-072-DV1-12	Left Side Of The House	1	2/3
13	S200-201-072-DV1-13	Headboard	1	1/3
14	S200-201-072-DV1-14	Left Roof Of The House	1	2/3
15	S200-201-072-DV1-15	Right Side Of The House	1	2/3
16	S200-201-072-DV1-16	Upper Crossbar	1	3/3
17	S200-201-072-DV1-17	Drawer Front	1	3/3
18	S200-201-072-DV1-18	Drawer Crossbar	2	2/3
19	S200-201-072-DV1-19	Right Drawer Side	1	2/3
20	S200-201-072-DV1-20	Drawer Botom	2	2/3
21	S200-201-072-DV1-21	Drawer Divider	1	1/3
22	S200-201-072-DV1-22	Lef tDrawer Side	1	2/3
23	S200-201-072-DV1-23	Drawer Back	1	3/3
24	S200-201-072-DV1-24	Vertical Drawer Stop	2	3/3

FITTINGS LIST

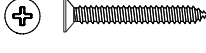
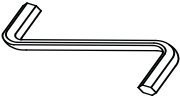
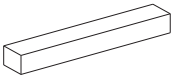
<p>A</p>  <p style="text-align: center;">Glue (3x)</p>	<p>B</p>  <p style="text-align: center;">2/+ Dowel Ø6,0 x 30mm (19x)</p>	<p>C</p>  <p style="text-align: center;">1/+ Cam Nut 15mm (13x)</p>	<p>D</p>  <p style="text-align: center;">1/+ Flat Head Screw Ø4,0 x 40mm (5x)</p>
<p>E</p>  <p style="text-align: center;">Drawer caster (4x)</p>	<p>F</p>  <p style="text-align: center;">1/+ Dowel Ø8,0 x 20mm (2x)</p>	<p>G</p>  <p style="text-align: center;">1/+ Cam Bolt (17x)</p>	<p>H</p>  <p style="text-align: center;">1/+ Pan Head Screw Ø3,5 x 14mm (16x)</p>
<p>I</p>  <p style="text-align: center;">1/+ Cam Nut 12mm (4x)</p>	<p>J</p>  <p style="text-align: center;">2/+ Hole Plugs White (13x)</p>	<p>K</p>  <p style="text-align: center;">1/+ Structural Screw Ø7 x 60mm (8x)</p>	<p>L</p>  <p style="text-align: center;">1/+ Flat Head Screw Ø3,5 x 30mm (18x)</p>
<p>M</p>  <p style="text-align: center;">1/+ Sliding Foot 15 x 15mm (11x)</p>	<p>N</p>  <p style="text-align: center;">2/+ Dowel Ø8,0 x 30mm (30x)</p>	<p>O</p>  <p style="text-align: center;">2/+ Nail 10x10 mm (11x)</p>	<p>P</p>  <p style="text-align: center;">1/+ Flat Head Screw Ø3,5 x 25mm (7x)</p>
<p>Q</p>  <p style="text-align: center;">1/+ Flat Head Screw Ø4,0 x 50mm (11x)</p>	<p>R</p>  <p style="text-align: center;">1/+ Hole Plugs (Ivory) (4x)</p>	<p>S</p>  <p style="text-align: center;">1/+ Flat Head Screw Ø3,5 x 20mm (8x)</p>	<p>T</p>  <p style="text-align: center;">Allen key (1x)</p>
<p>U</p>  <p style="text-align: center;">Spacer (2x)</p>			

TIPS FOR FITTINGS CAM-LOCKS

WHEN FITTING CAM NUT. ENSURE STARTING POSITION IS CORRECT BEFORE YOU INSERT CONNECTING CAM BOLT TURN CLOCKWISE UNTIL SECURE



↑
CORRECT



↑
WRONG

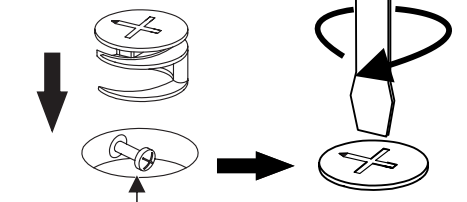

Cam bolt head needs to be in centre

CAMBOLT

Tighten until shoulder in flush with panel. Do not overtighten or undertighten (see example beside)

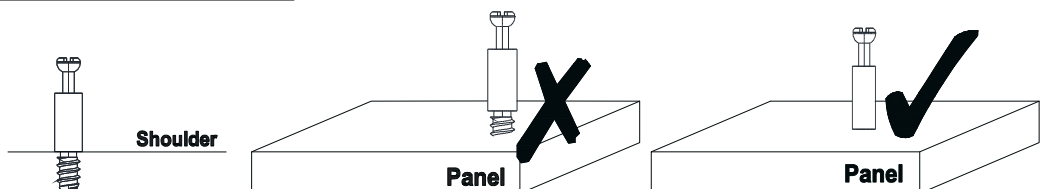



STEP 1

PARTS REQUIRED

6 - DRAWER STOP	x2
8 - RIGHT SIDE RAIL	x1
9 - LEFT SIDE RAIL	x1

HARDWARE REQUIRED

A	 Glue	01
F	 Ø8 x 20mm	02
N	 Ø8 x 30mm	06

TOOLS REQUIRED

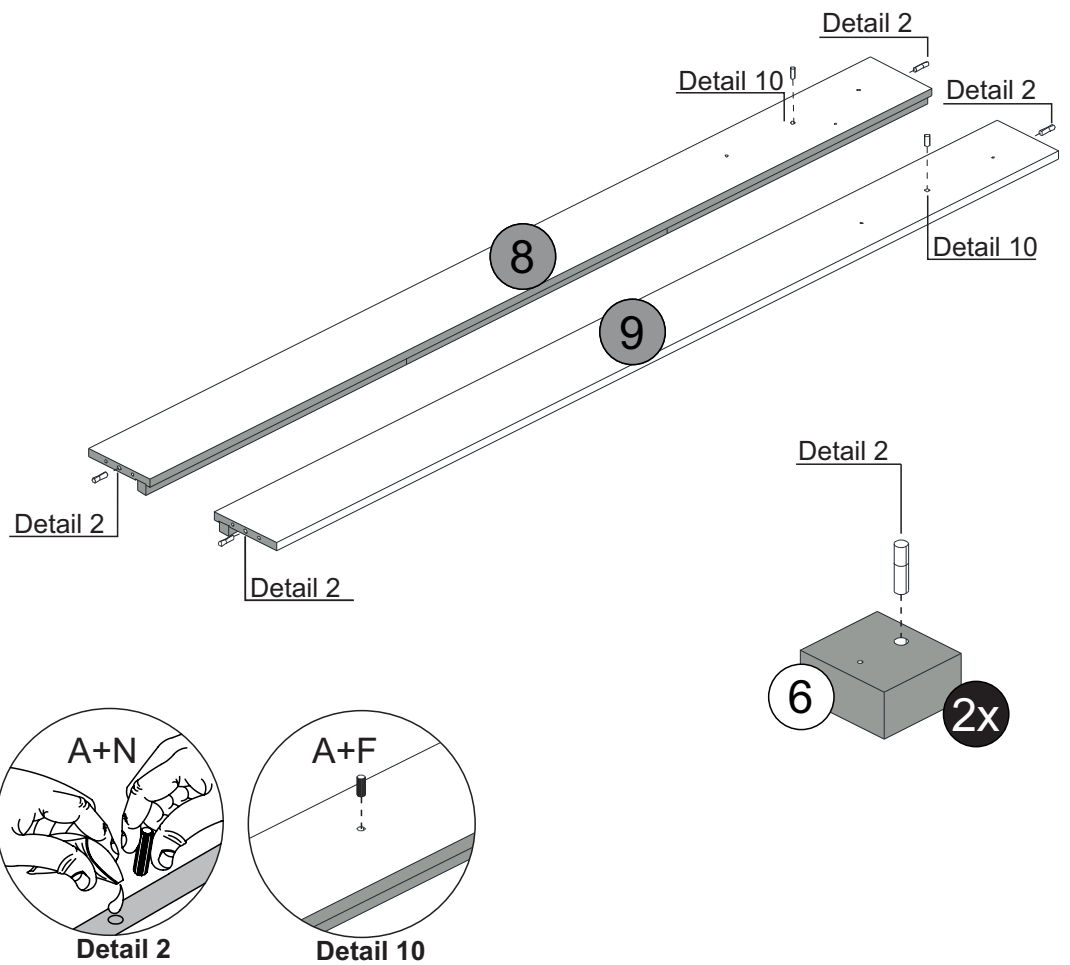
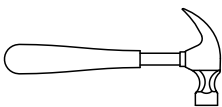



STEP 2

PARTS REQUIRED

5 - FOOTBOARD	x1
6 - DRAWER STOP	x1

HARDWARE REQUIRED

A	 Glue	01
D	 Ø4,0 x 40mm	01

TOOLS REQUIRED

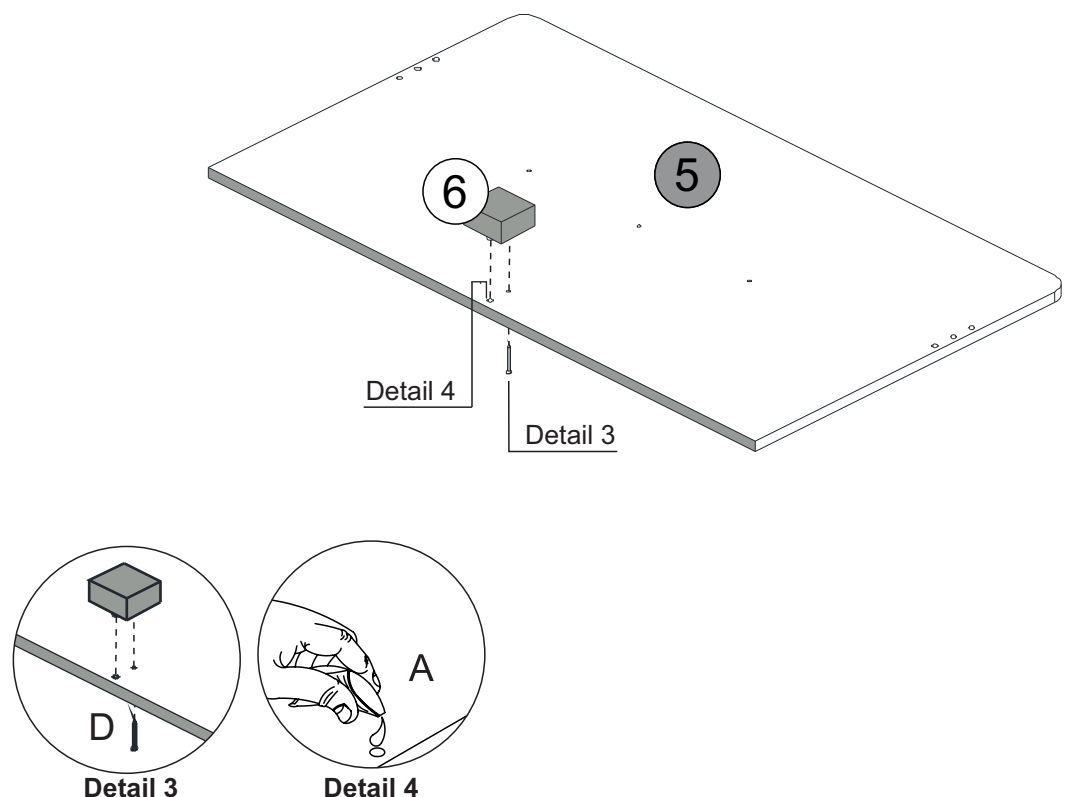
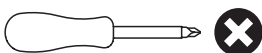

STEP 3

PARTS REQUIRED

5 - FOOTBOARD	x1
13 - HEADBOARD	x1

HARDWARE REQUIRED

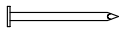
M		04
O		04

TOOLS REQUIRED

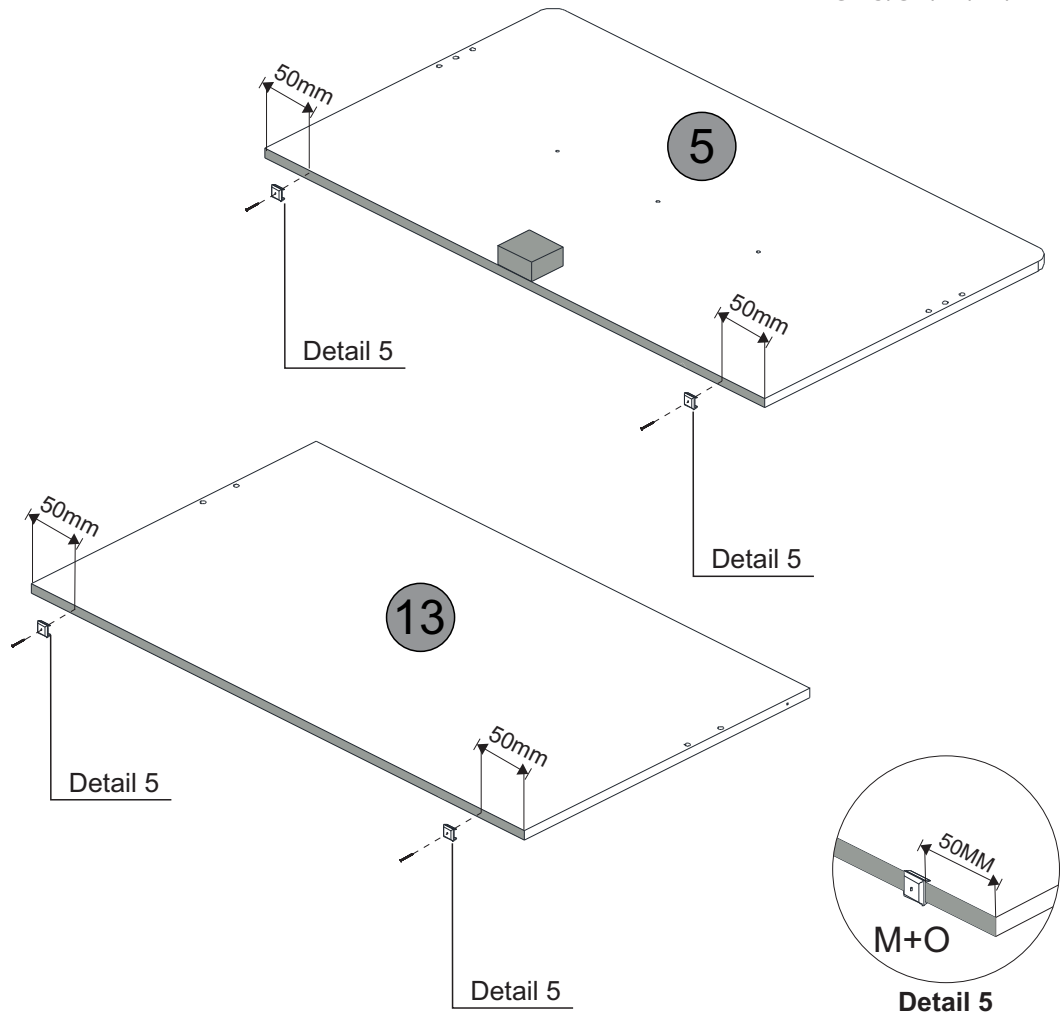
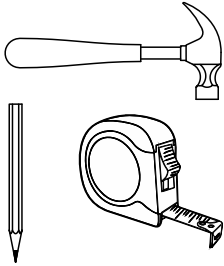

STEP 4

PARTS REQUIRED

6- DRAWER STOP	x1
7- LOWER CROSSBAR	x1
16- UPPER CROSSBAR	x1

HARDWARE REQUIRED

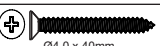
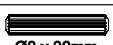
A		01
D		01
N		06

TOOLS REQUIRED

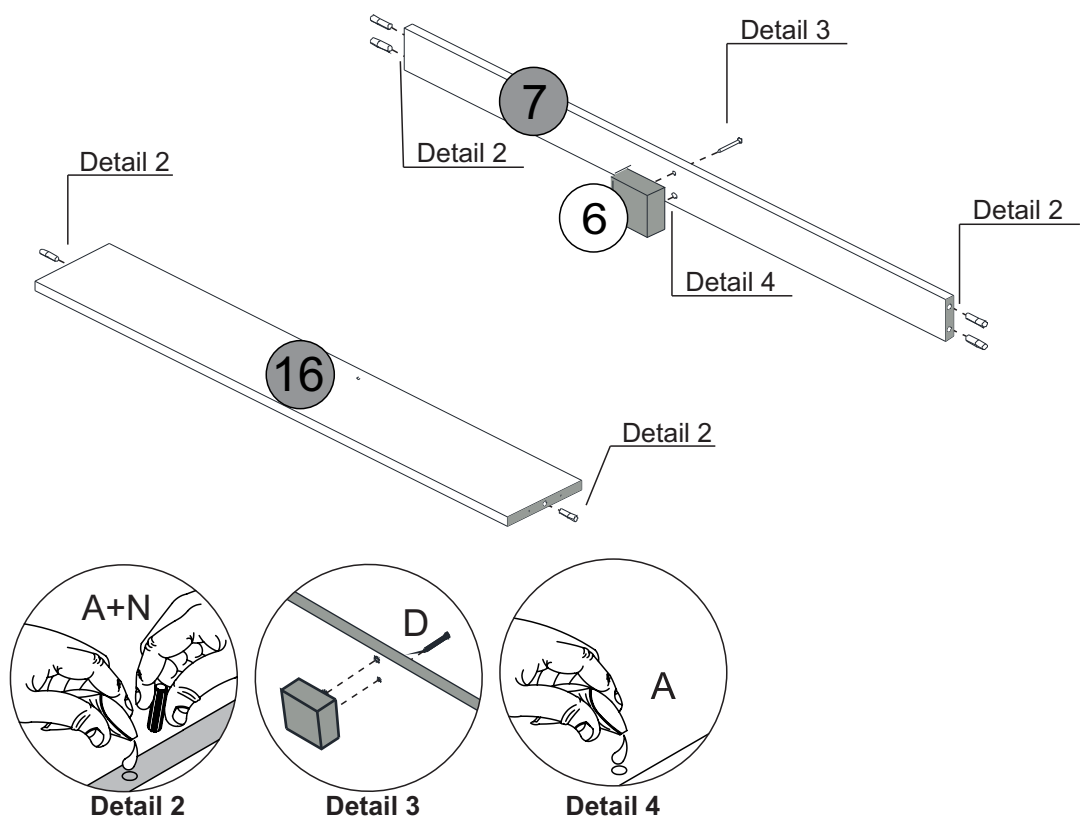
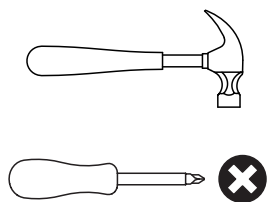





STEP 5

PARTS REQUIRED

12 - LEFT SIDE OF THE HOUSE x1

HARDWARE REQUIRED

- A  01
- B  Ø6 x 30mm 03
- M  02
- O  02

TOOLS REQUIRED

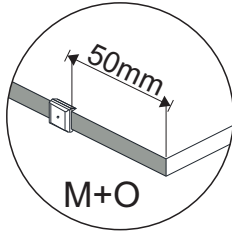
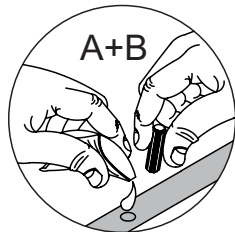
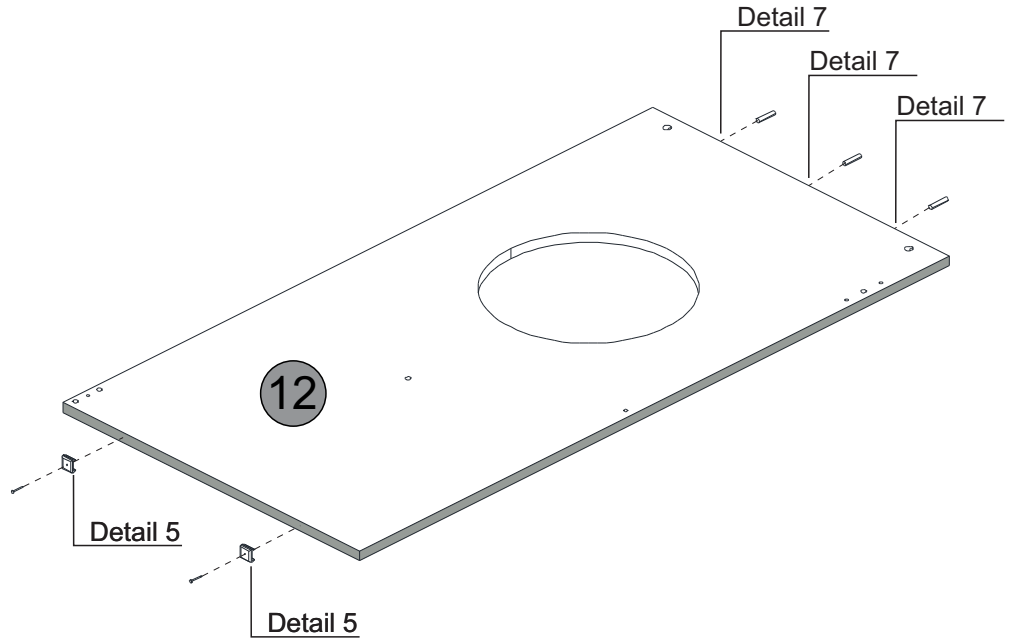
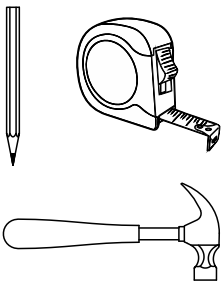

Detail 7





Detail 5

STEP 6

PARTS REQUIRED

11 - RIGHT SIDE OF THE HOUSE x1

HARDWARE REQUIRED

- A  01
- B  Ø6 x 30mm 03
- M  02
- O  02

TOOLS REQUIRED

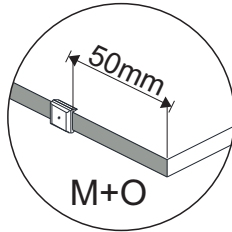
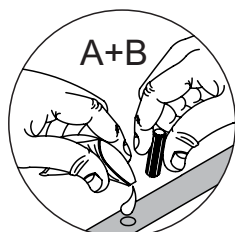
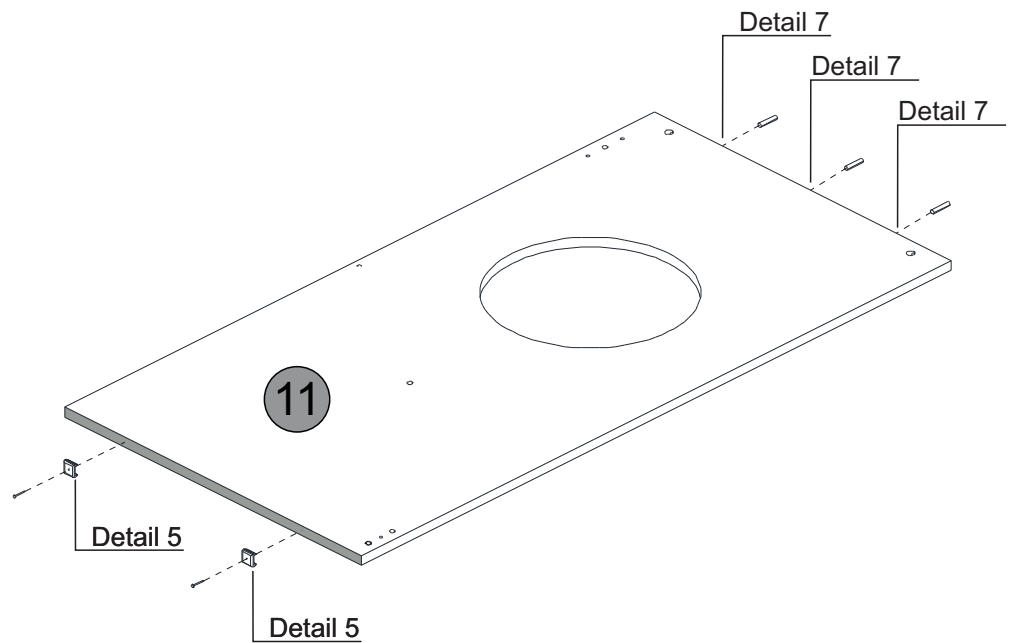
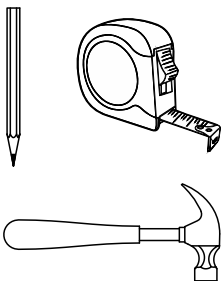

Detail 7

Detail 5

STEP 7

PARTS REQUIRED

14-LEFT ROOF OF THE HOUSE x1

15-RIGHT ROOF OF THE HOUSE x1

HARDWARE REQUIRED

A  01

B  02
Ø6 x 30mm

G  04

TOOLS REQUIRED

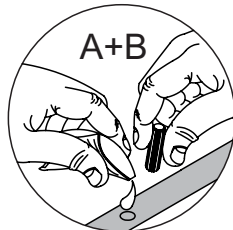
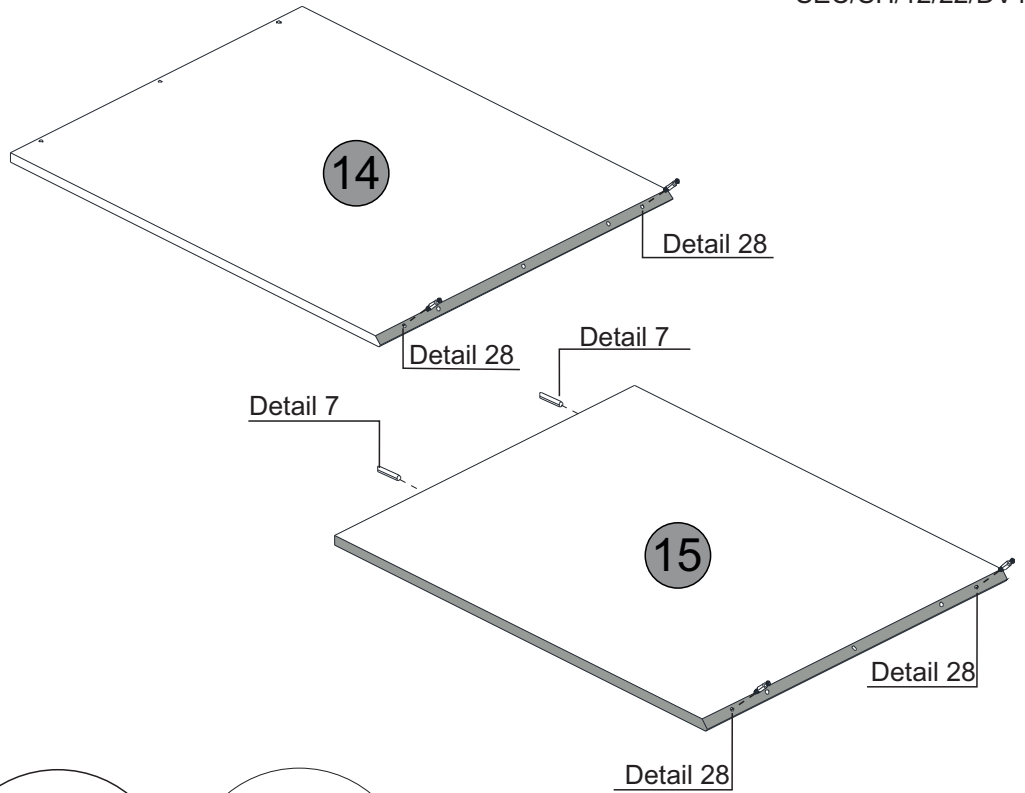
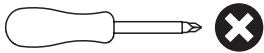

Detail 7

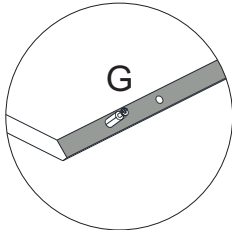

Detail 28

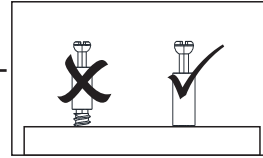

STEP 8

PARTS REQUIRED

14-LEFT ROOF OF THE HOUSE x1

15-RIGHT ROOF OF THE HOUSE x1

HARDWARE REQUIRED

A  01

Q  03
Ø4,0 x 50mm

TOOLS REQUIRED

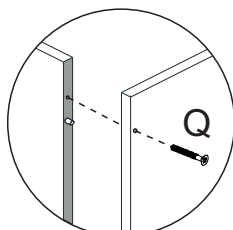
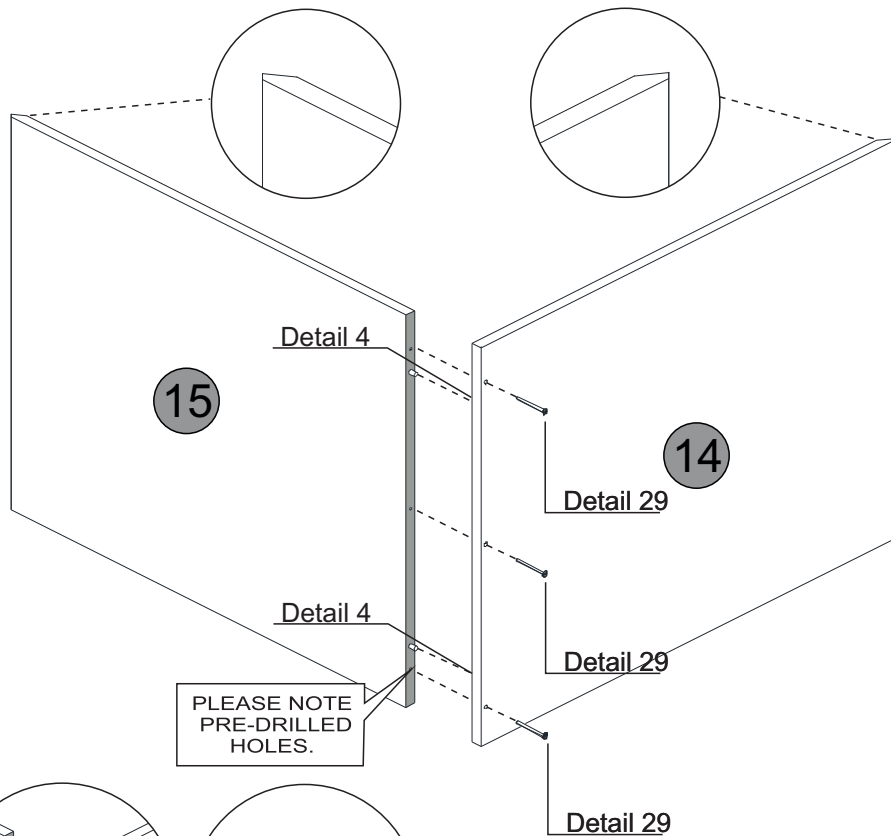
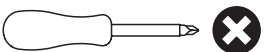

Detail 29

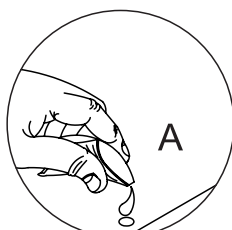





Detail 4

STEP 9

PARTS REQUIRED

- 1 - RIGHT SIDE OF SEAT x1
- 2 - LEFT SIDE OF SEAT x1

HARDWARE REQUIRED

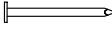
- A  01
- B  04
- G  04
- M  02
- O  02

TOOLS REQUIRED

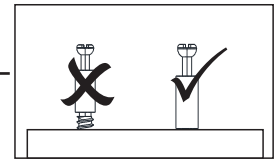
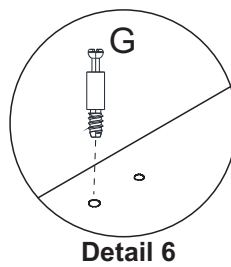
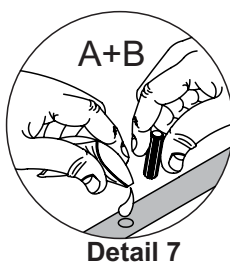
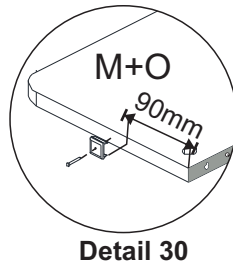
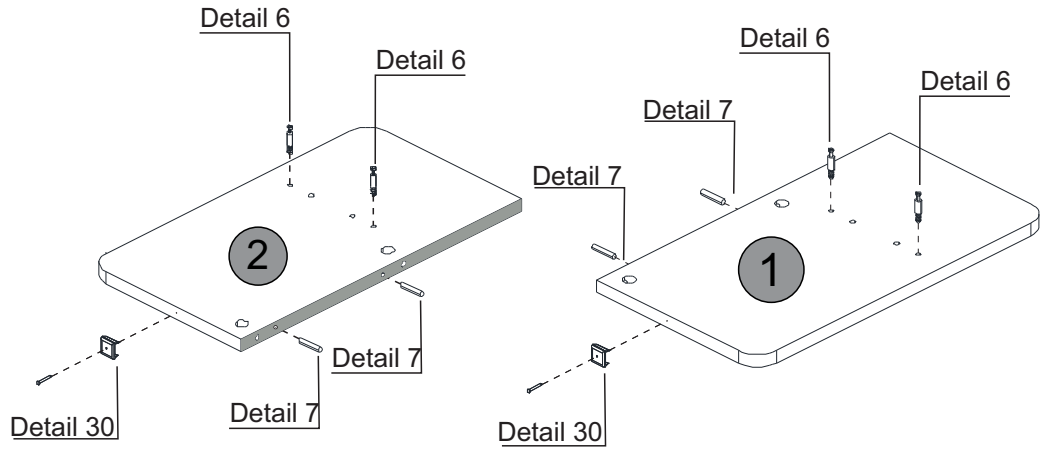
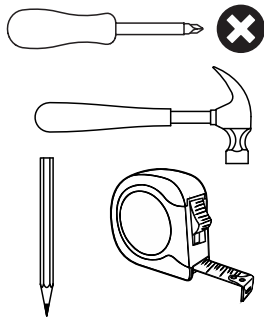





STEP 10

PARTS REQUIRED

- 4 - CENTRE DIVIDER x1

HARDWARE REQUIRED

- A  01
- B  03
- M  01
- O  01

TOOLS REQUIRED

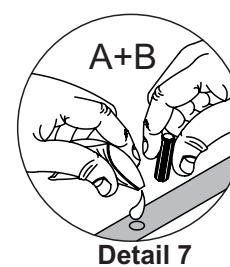
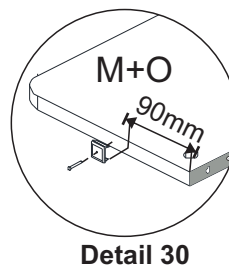
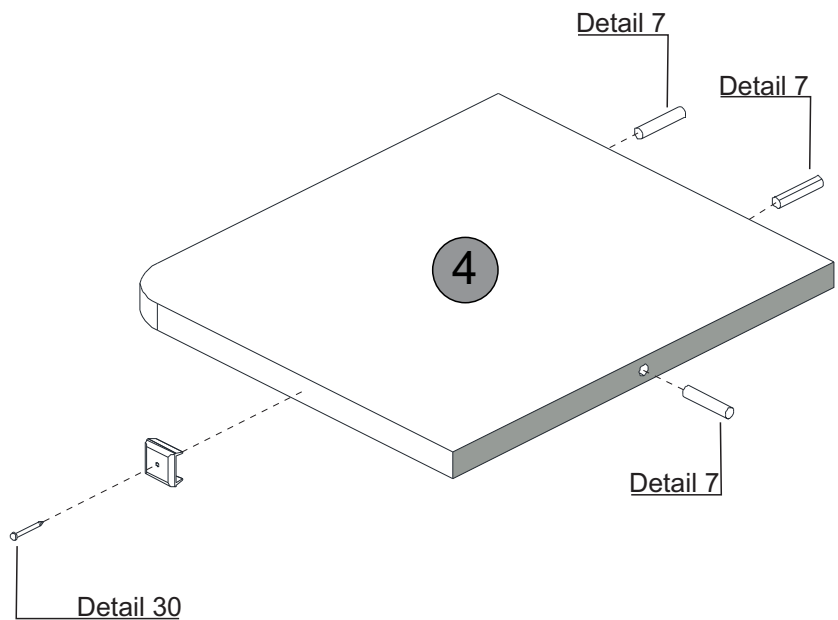
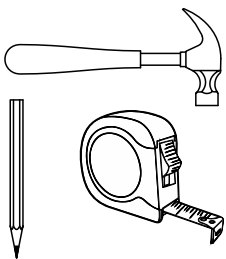

STEP 11

PARTS REQUIRED

3 - SEAT SHELF x1

HARDWARE REQUIRED

A  01

B  Ø6 x 30mm 04

G  02

TOOLS REQUIRED

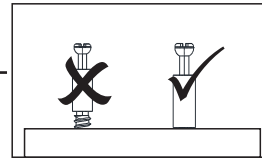
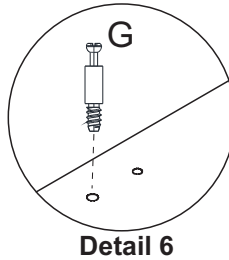
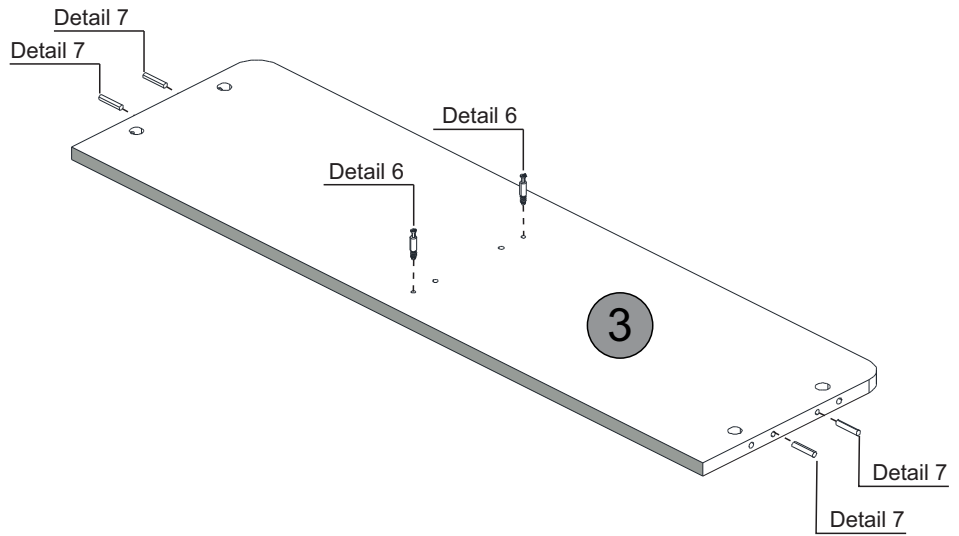
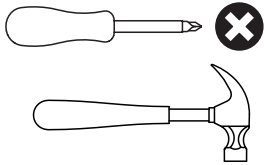

STEP 12

PARTS REQUIRED

5 - FOOTBOARD x1

8 - RIGHT SIDE RAIL x1

9 - LEFT SIDE RAIL x1

HARDWARE REQUIRED

A  01

K  Ø7 x 60mm 04

TOOLS REQUIRED

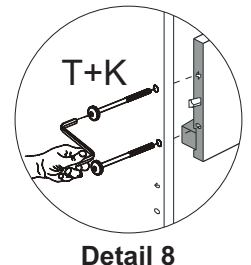
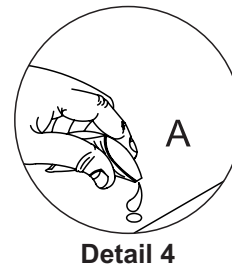
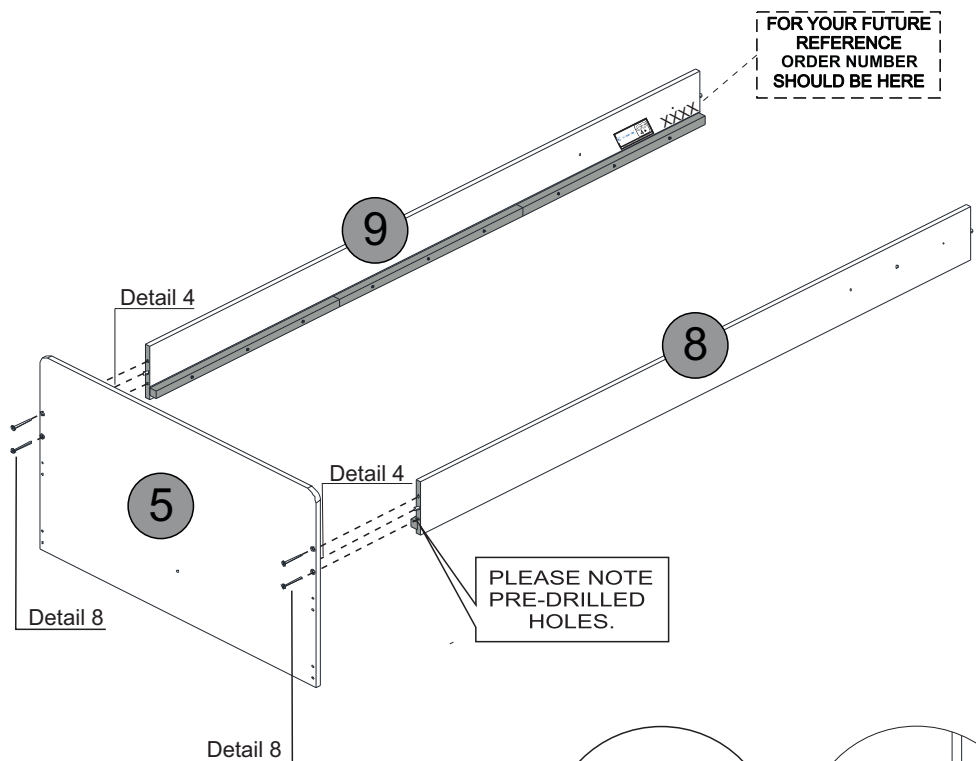
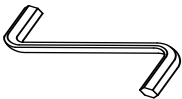

STEP 13

PARTS REQUIRED

13 - HEADBOARD x1

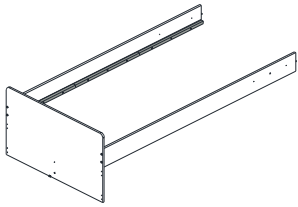

HARDWARE REQUIRED

A  01

K  Ø7 x 60mm 04

TOOLS REQUIRED

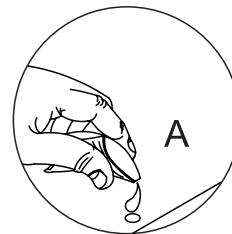
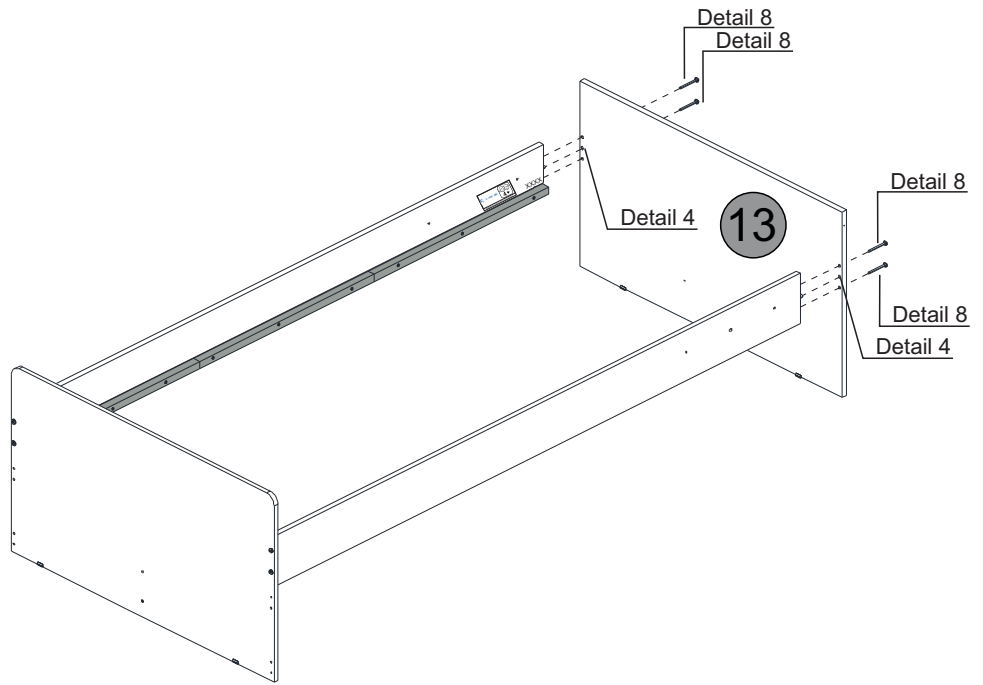
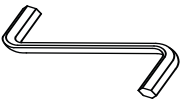

Detail 4

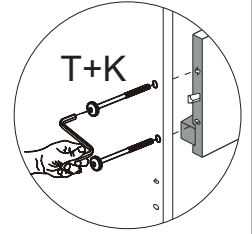

Detail 8

STEP 14

PARTS REQUIRED

12-LEFT SIDE OF THE HOUSE x1

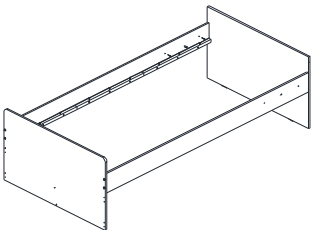

HARDWARE REQUIRED

A  01

P  Ø3,5 x 25mm 02

TOOLS REQUIRED

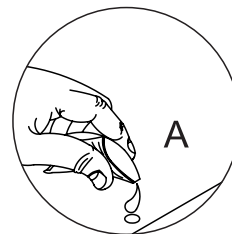
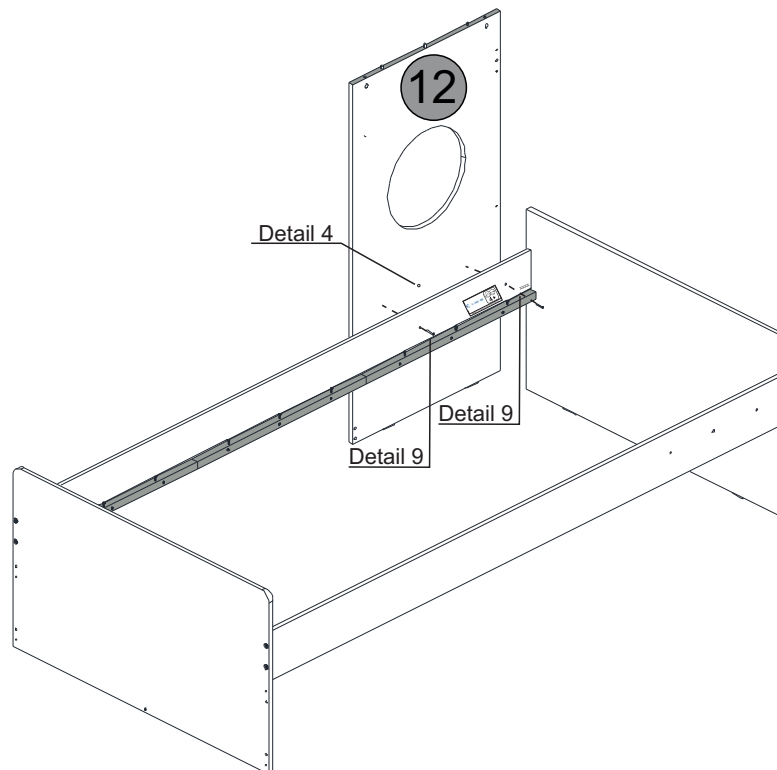
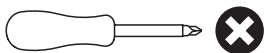

Detail 4

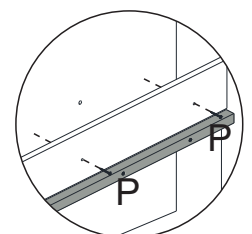

Detail 9

STEP 15

PARTS REQUIRED

7-LOWER CROSSBAR x1

16 - UPPER CROSSBAR x1

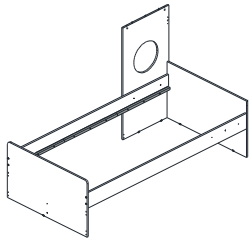

HARDWARE REQUIRED

A 01

Q 04
Ø4 x 50mm

TOOLS REQUIRED

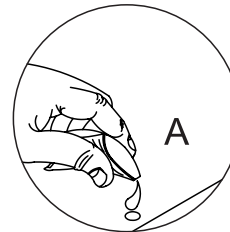
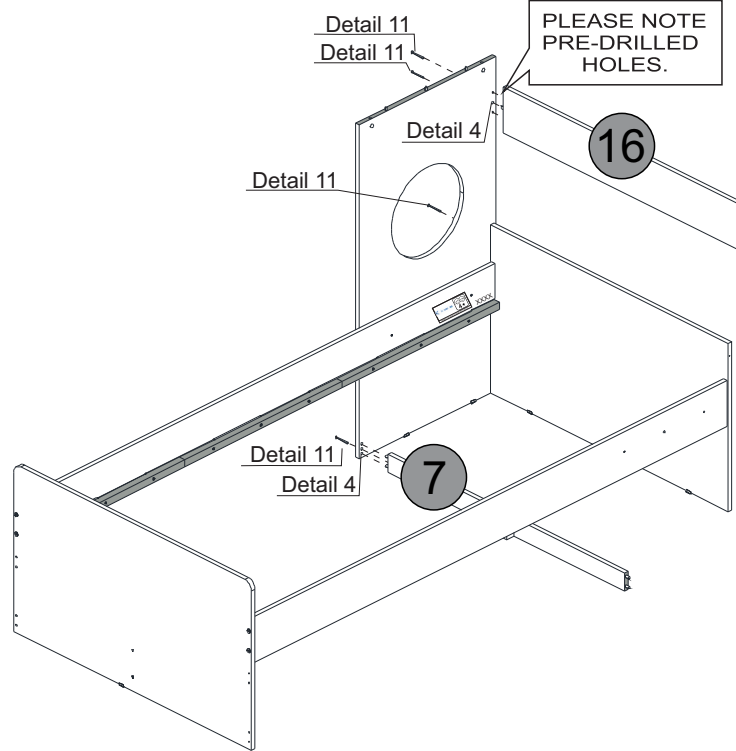
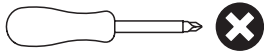

Detail 4

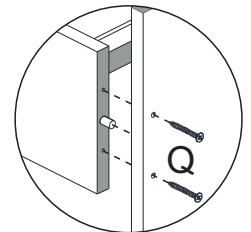

Detail 11

STEP 16

PARTS REQUIRED

11-RIGHT SIDE OF THE HOUSE x1

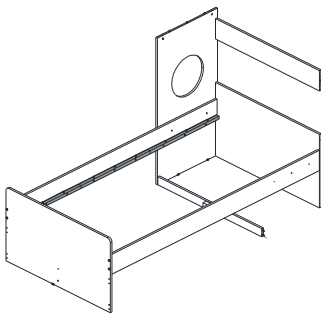

HARDWARE REQUIRED

A 01

P 02
Ø3,5 x 25mm

Q 04
Ø4 x 50mm

TOOLS REQUIRED

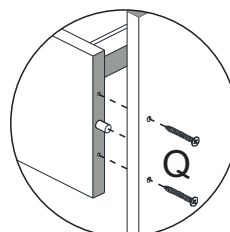
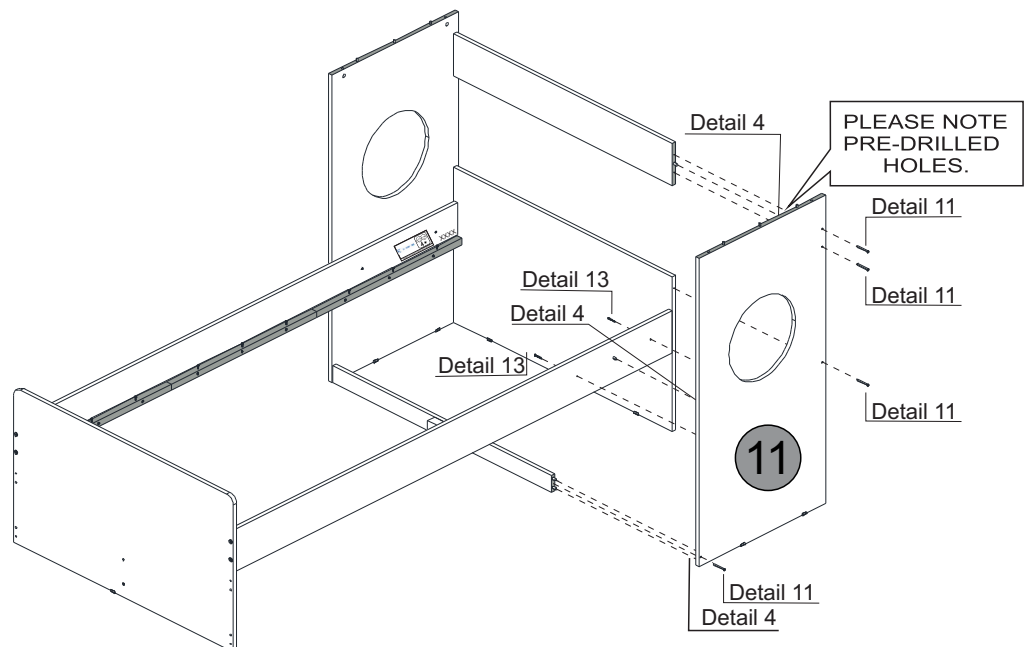
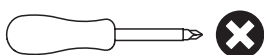

Detail 11

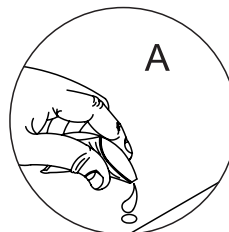

Detail 4

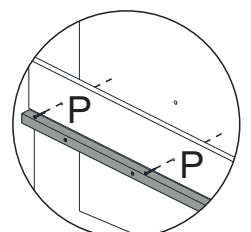

Detail 13

STEP 17

PARTS REQUIRED

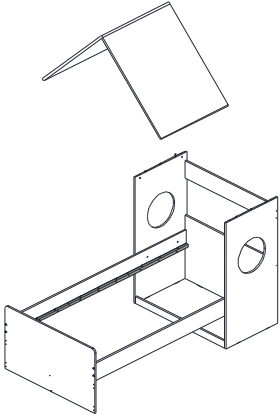

HARDWARE REQUIRED

A		01
I	Ø12mm	04
R		04

TOOLS REQUIRED

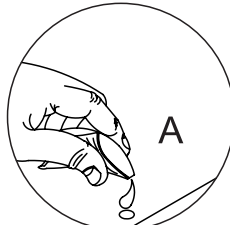
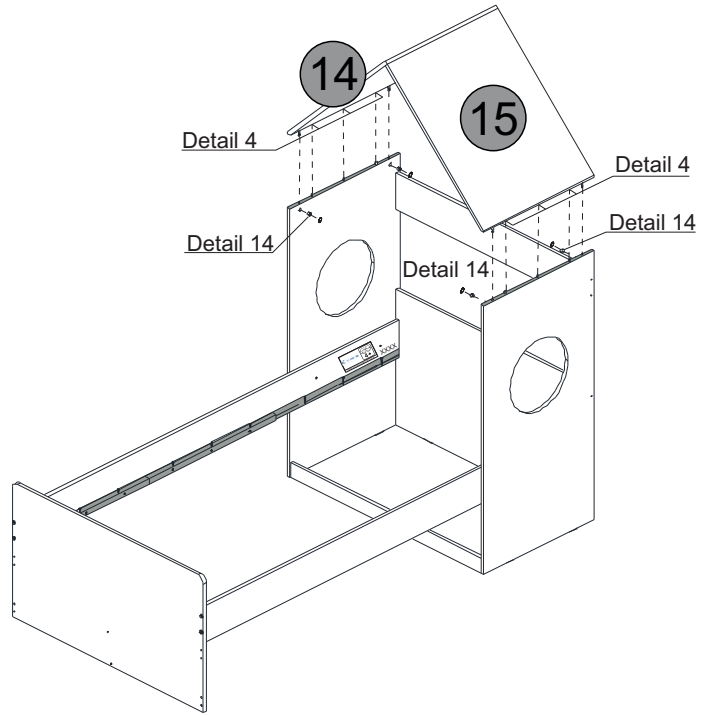
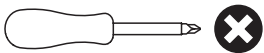

Detail 4

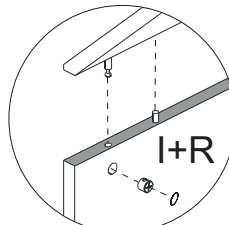

Detail 14

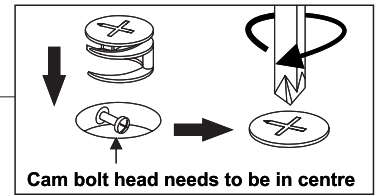

Cam bolt head needs to be in centre

STEP 18

PARTS REQUIRED

3 - SEAT SHELF	x1
4 - CENTRE DIVIDER	x1

HARDWARE REQUIRED

A		01
C		02
J		02

TOOLS REQUIRED

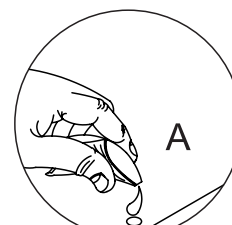
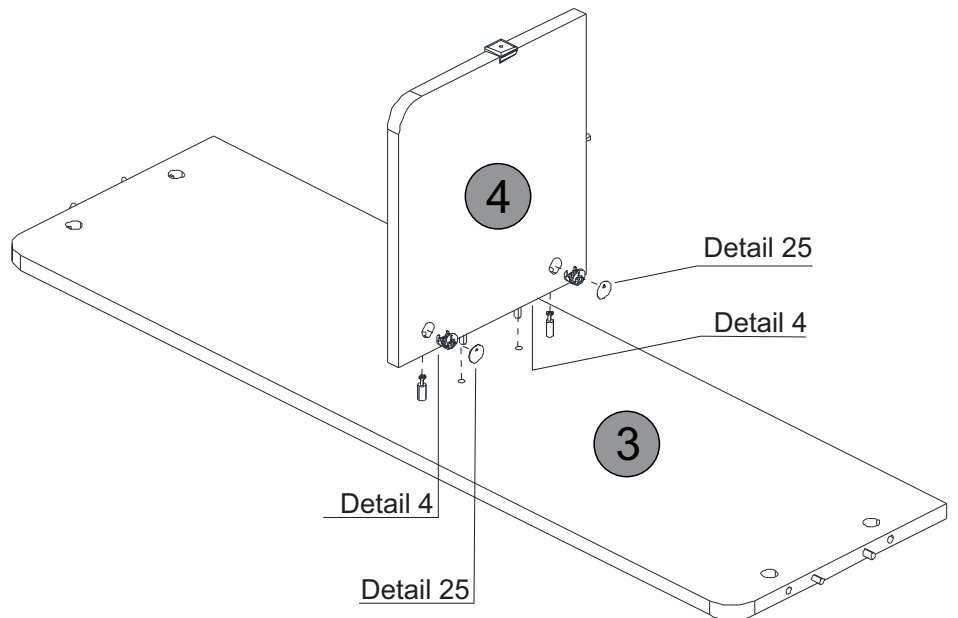
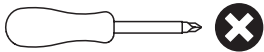

Detail 4

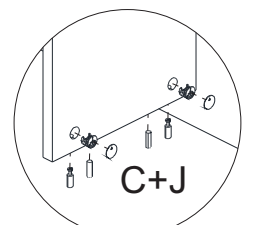

Detail 25

STEP 19

PARTS REQUIRED

1 - RIGHT SIDE OF SEAT x1

2 - LEFT SIDE OF SEAT x1

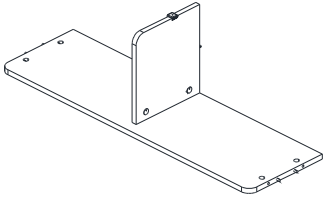

HARDWARE REQUIRED

A  01

C  04

J  04

TOOLS REQUIRED

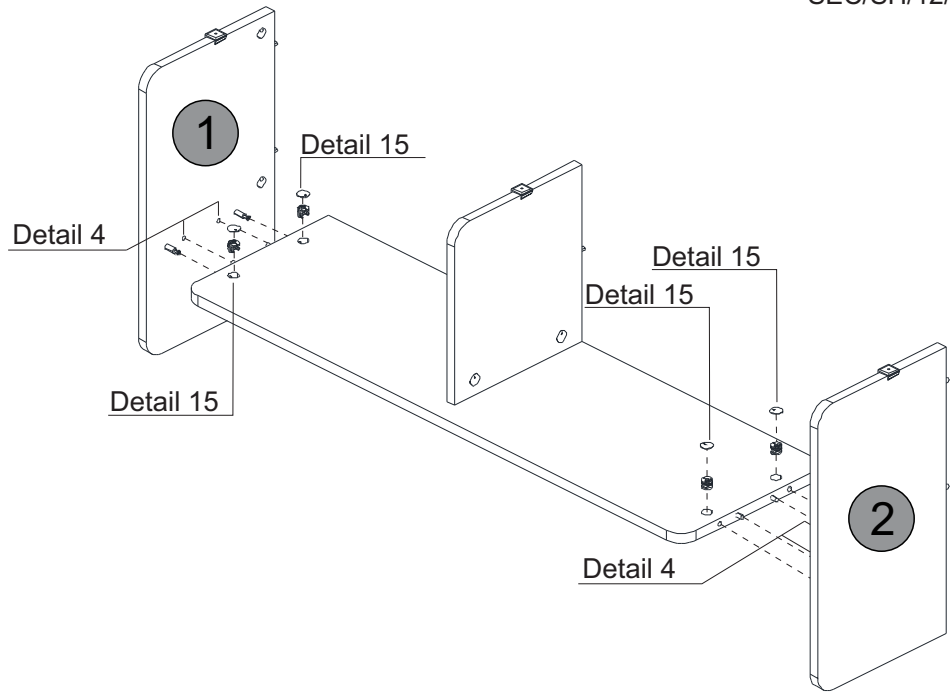
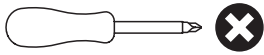

Detail 4

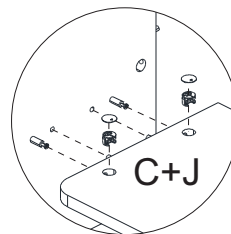

Detail 15

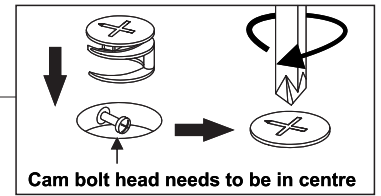

STEP 20

PARTS REQUIRED

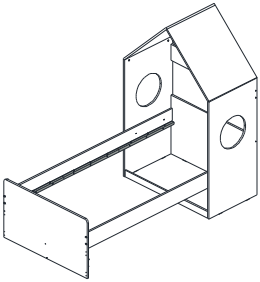

HARDWARE REQUIRED

G  04

TOOLS REQUIRED

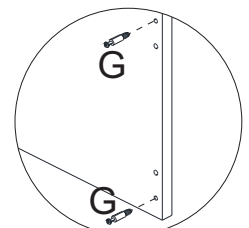
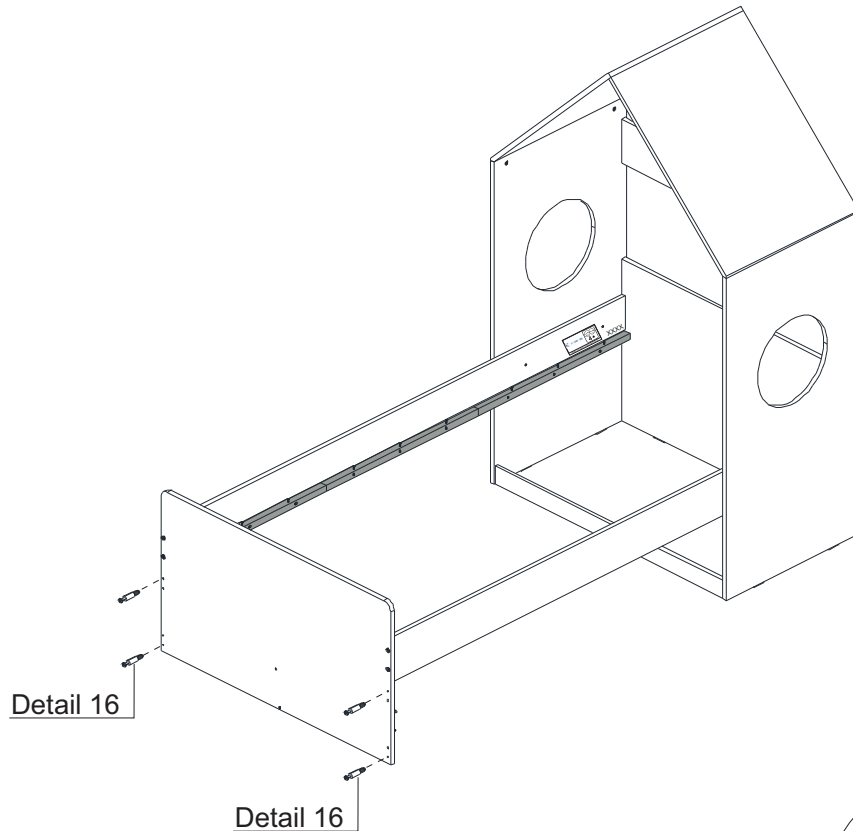
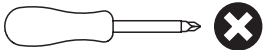

Detail 16

STEP 21

PARTS REQUIRED

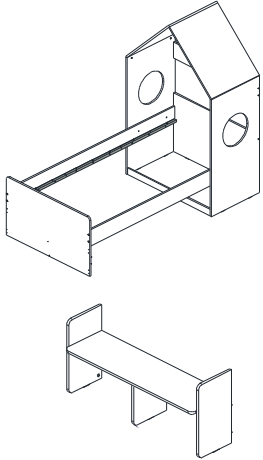

HARDWARE REQUIRED

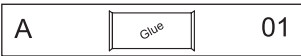

TOOLS REQUIRED

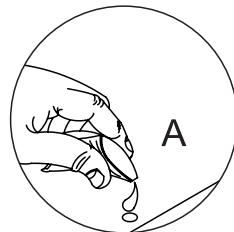
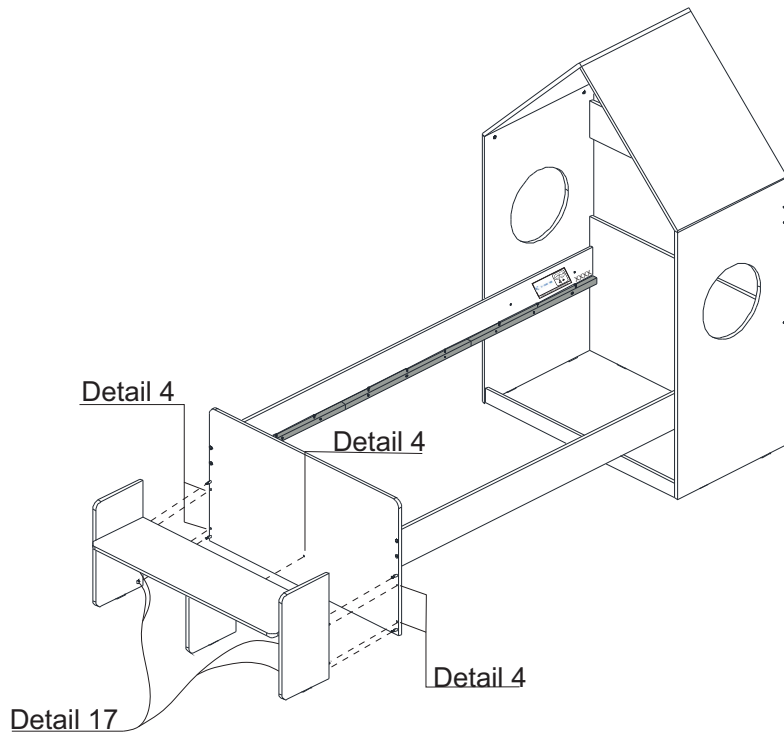
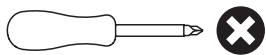

Detail 4

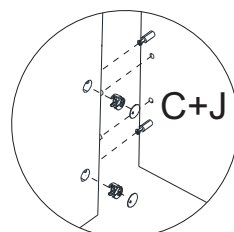

Detail 17

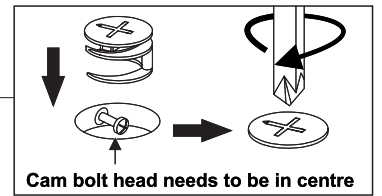

STEP 22

PARTS REQUIRED

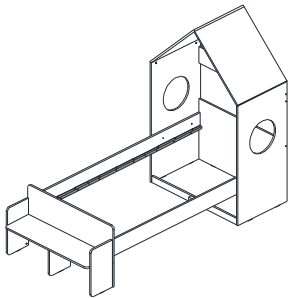

HARDWARE REQUIRED

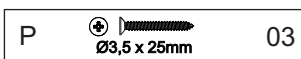

TOOLS REQUIRED

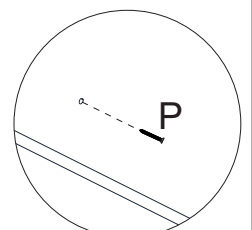
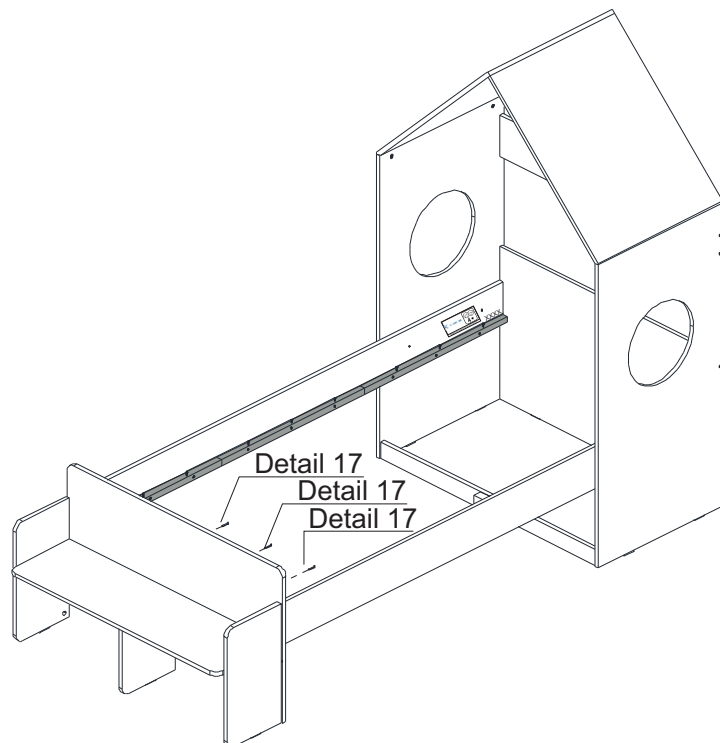
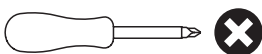

Detail 17

STEP 23

PARTS REQUIRED

18 - DRAWER CROSSBAR	x2
19 - RIGHT DRAWER SIDE	x1
21 - DRAWER DIVIDER	x1
22 - LEFT DRAWER SIDE	x1
23 - DRAWER BACK	x1

HARDWARE REQUIRED

A		01
---	---	----

N		18
---	---	----

TOOLS REQUIRED

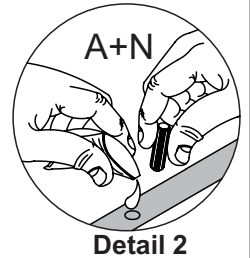
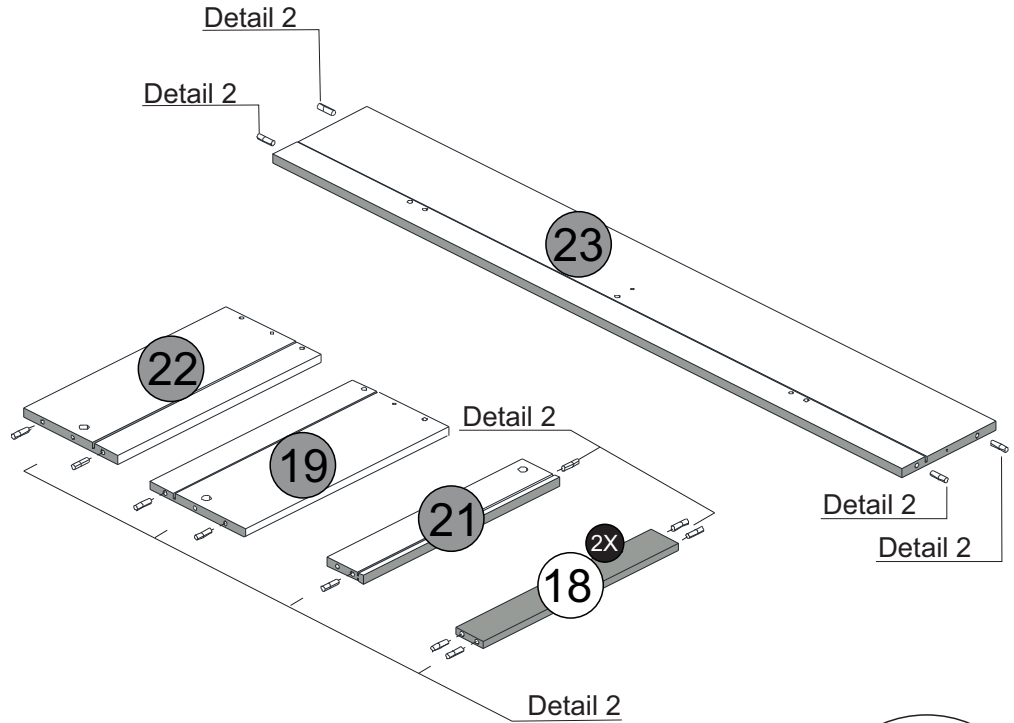

STEP 24

PARTS REQUIRED

17-DRAWER FRONT	x1
-----------------	----

HARDWARE REQUIRED

G		03
---	---	----

TOOLS REQUIRED

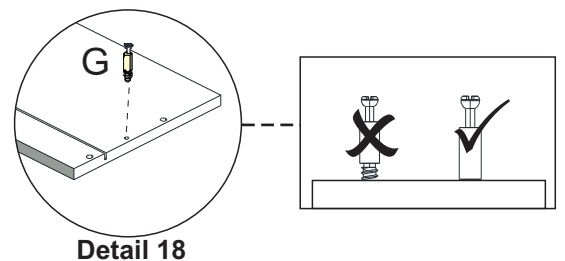
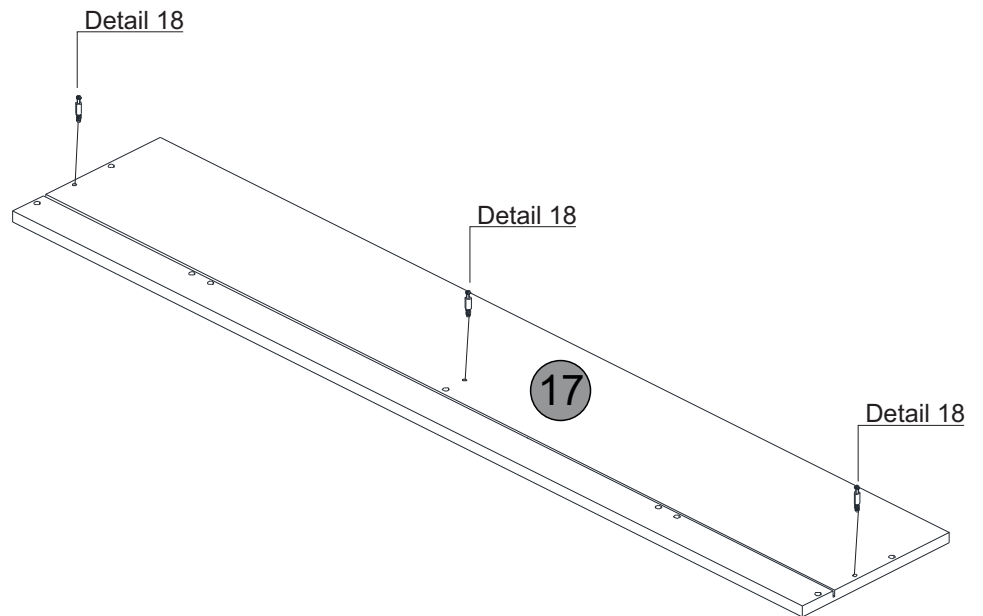
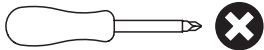



STEP 25

PARTS REQUIRED

17 - DRAWER FRONT	x1
19 - RIGHT DRAWER SIDE	x1
21 - DRAWER DIVIDER	x1
22 - LEFT DRAWER SIDE	x1

HARDWARE REQUIRED

A		01
C		03
J		03

TOOLS REQUIRED

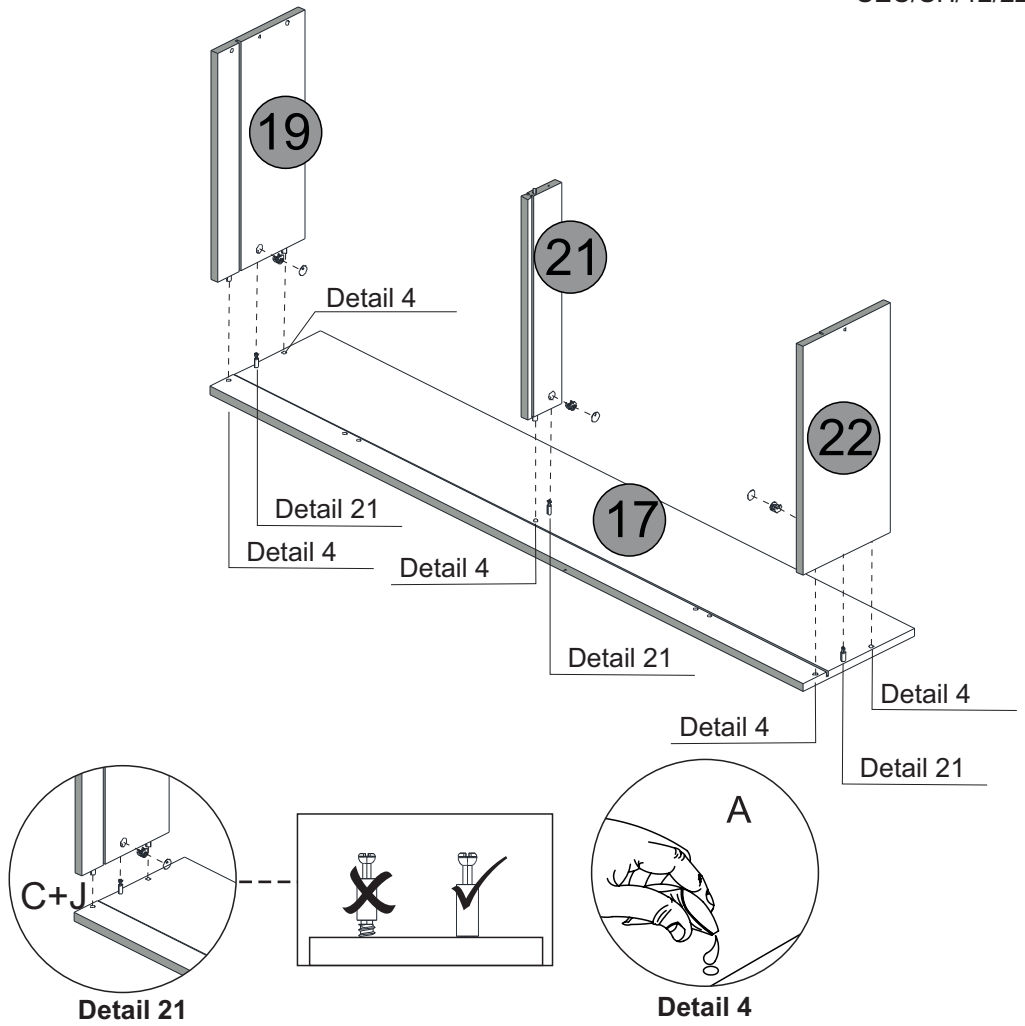
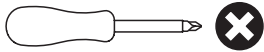

STEP 26

PARTS REQUIRED

20 - DRAWER BOTTOM	x2
--------------------	----

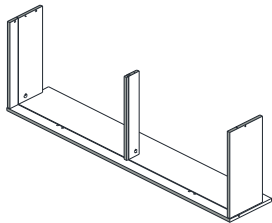

HARDWARE REQUIRED

TOOLS REQUIRED

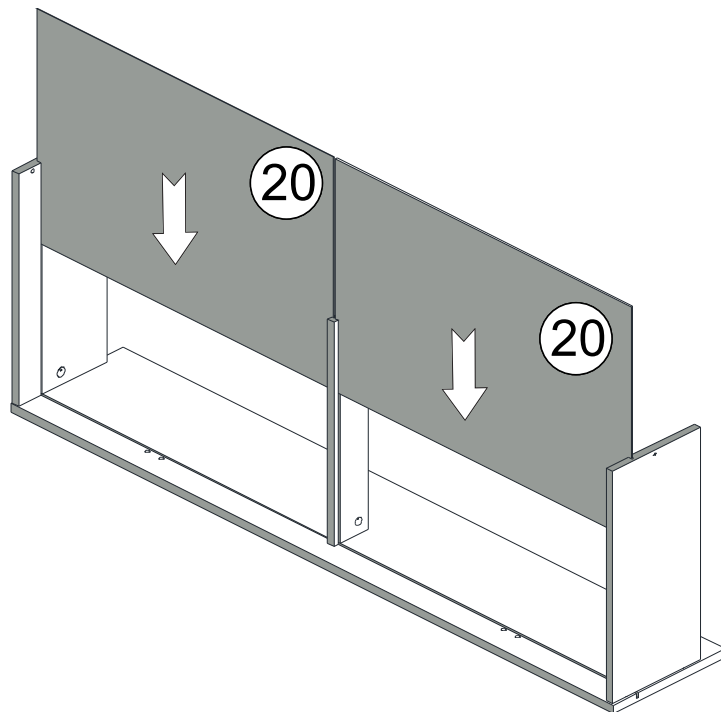

STEP 27

PARTS REQUIRED

18-DRAWER CROSSBAR X2

HARDWARE REQUIRED

A  01

TOOLS REQUIRED

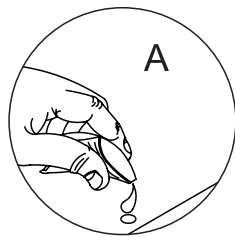
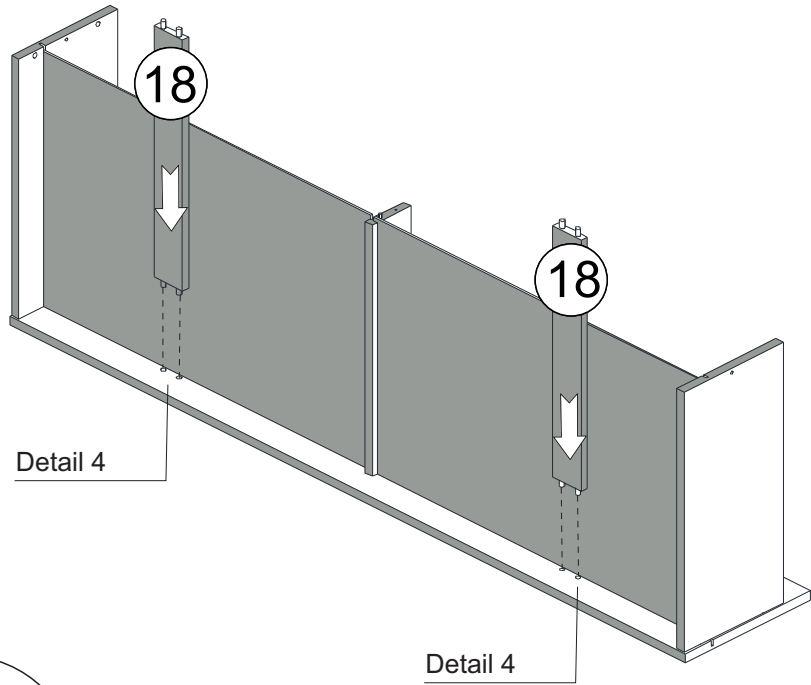

Detail 4

STEP 28

PARTS REQUIRED

23 - DRAWER BACK x1

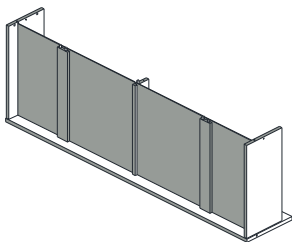

HARDWARE REQUIRED

A  01

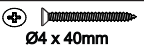
D  Ø4 x 40mm 03

TOOLS REQUIRED

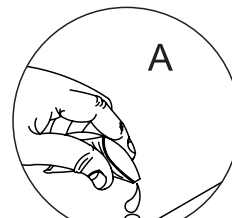
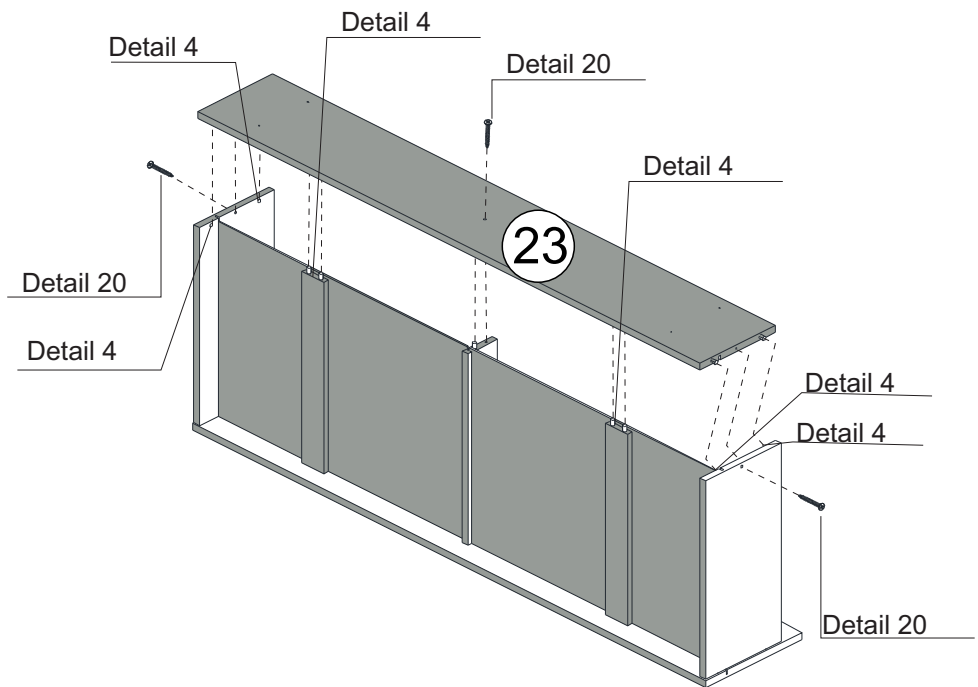

Detail 4

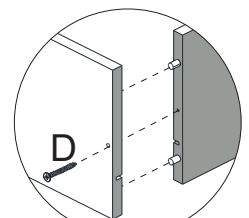



Detail 20

STEP 29

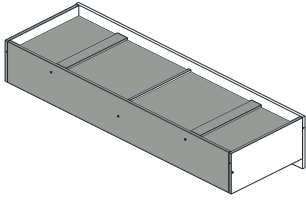
PARTS REQUIRED



HARDWARE REQUIRED

E		04
H		16

TOOLS REQUIRED

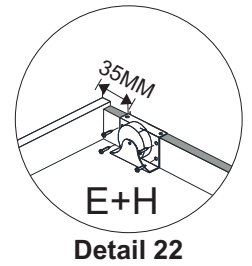
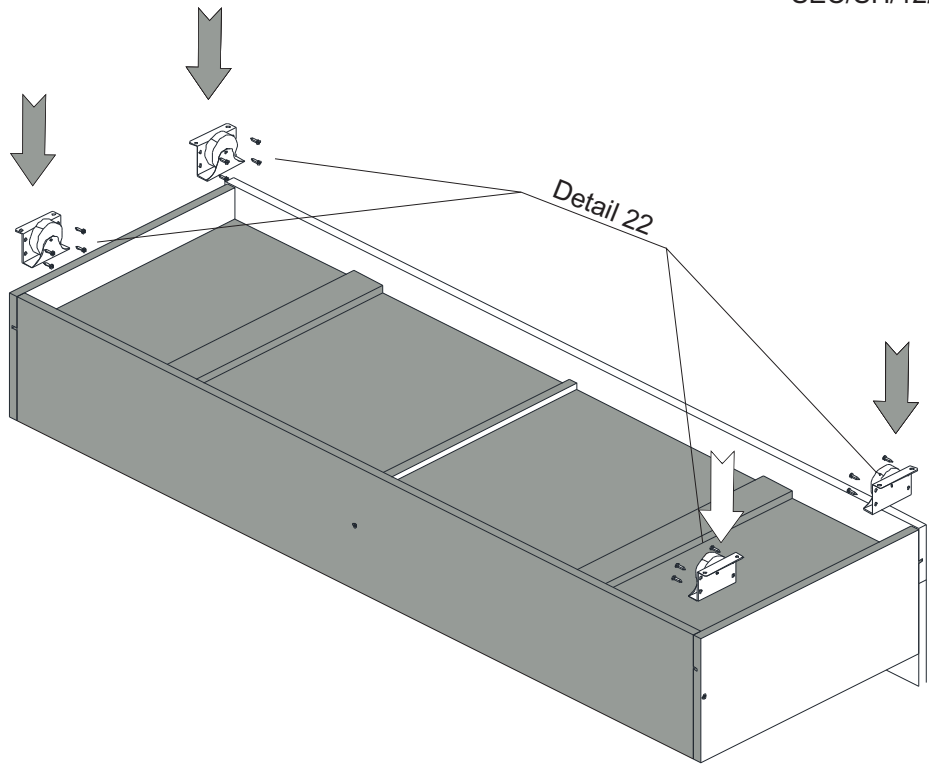
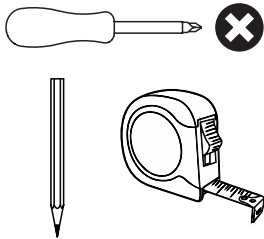

STEP 30

PARTS REQUIRED

24 - VERTICAL DRAWER STOP	X2
---------------------------	----

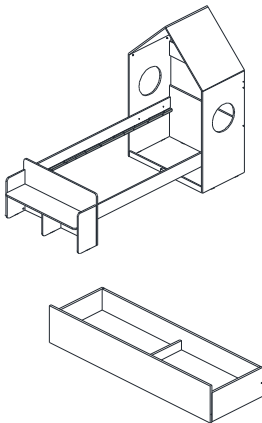

HARDWARE REQUIRED

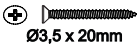
S		08
---	---	----

TOOLS REQUIRED

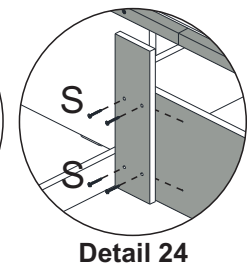
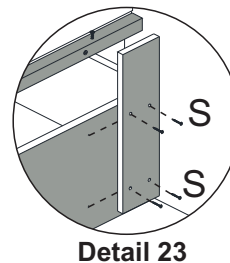
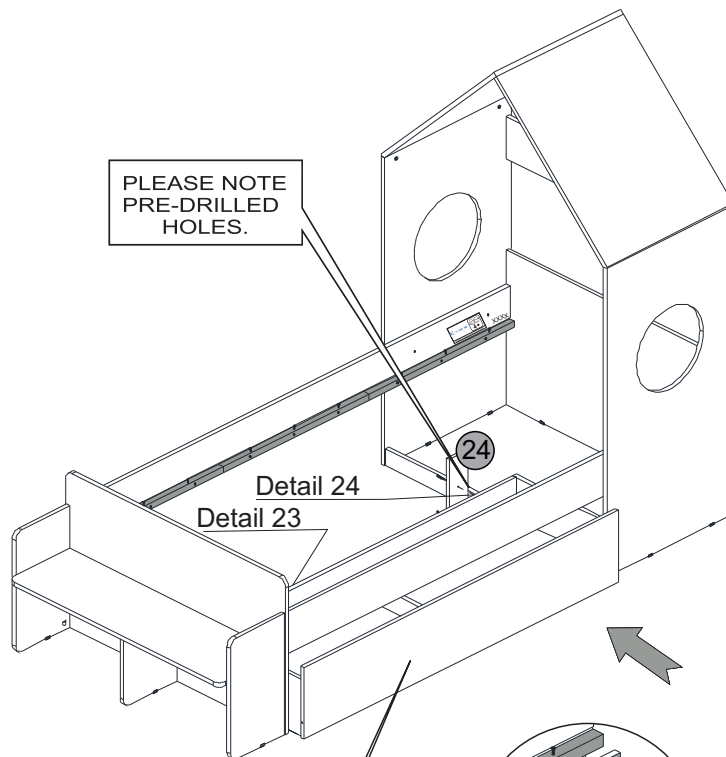
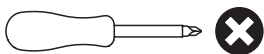

THE DRAWER CAN BE
ADD ON BOTH SIDES
(RIGHT OR LEFT)

STEP 31

PARTS REQUIRED

10 - MATTRESS BASE X2

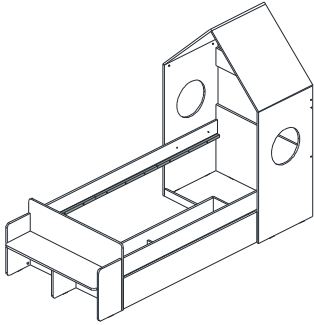

HARDWARE REQUIRED

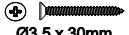
L  12
Ø3,5 x 30mm

TOOLS REQUIRED

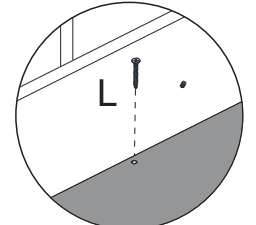
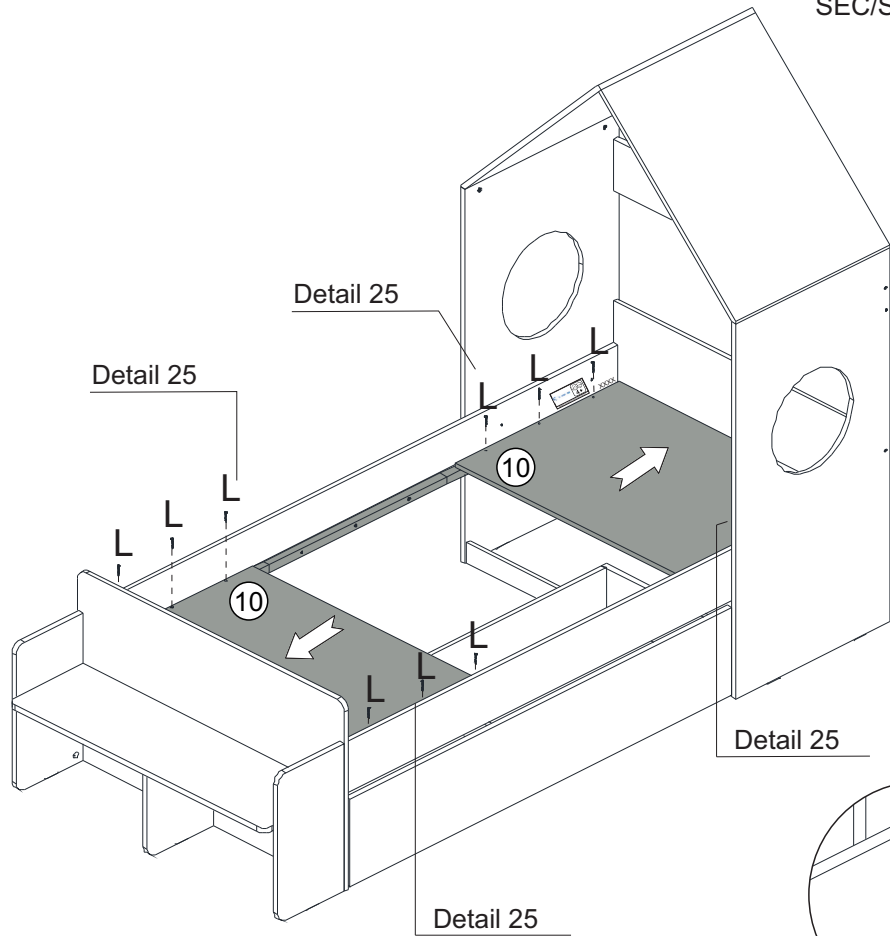
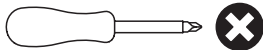

Detail 25

STEP 32

PARTS REQUIRED

10 - MATTRESS BASE X1

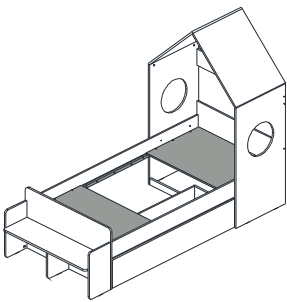

HARDWARE REQUIRED

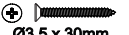
L  06
Ø3,5 x 30mm

U  02
Spacer

TOOLS REQUIRED

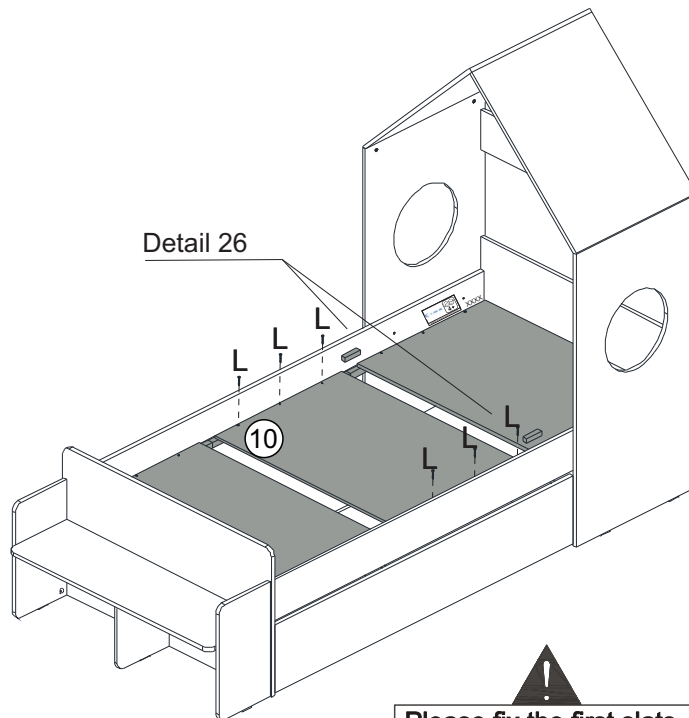
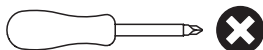

100KG
MAX BED
WEIGHT

!
Please fix the first slats adjacent to the headboard and footboard and work towards the middle of the bed using the spacer (U) as shown to ensure correct spacing. Fix all the slats to one siderail first then push the second siderail tight against the slats and fix.

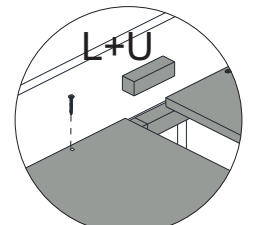

Detail 26