

PRADO 4' BED ASSEMBLY INSTRUCTIONS

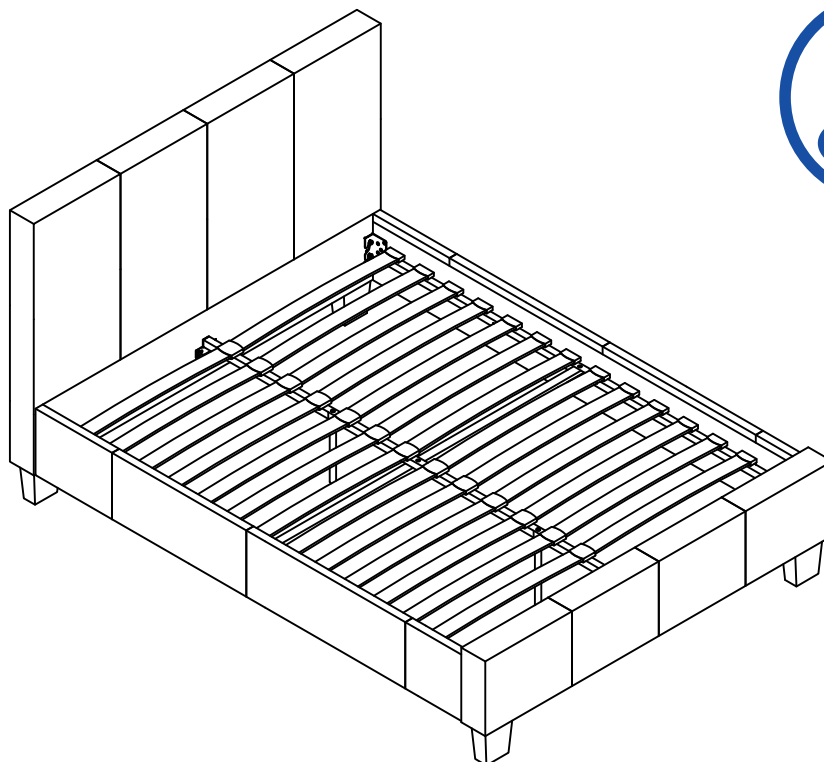

IMPORTANT

PLEASE READ BEFORE YOU CONTINUE FURTHER

THE PRODUCT YOU HAVE PURCHASED WILL GIVE YOU MANY YEARS OF SERVICE IF YOU FOLLOW THE GUIDELINES FOR ITS SAFE ASSEMBLY AND PERIODIC MAINTENANCE AND CLEANING.

DO NOT USE ANY TOOLS OTHER THAN THOSE SHOWN.

ANY SPANNERS OR ALLEN KEYS REQUIRED ARE INCLUDED WITH THE FITTINGS KIT.

DO NOT FOR ANY REASON USE A POWER TOOL TO ASSEMBLE THIS PRODUCT . ITS USE WILL INVALIDATE ANY CLAIM YOU MAY HAVE AND COULD MAKE THIS PRODUCT UNSAFE.

DEPENDING ON THE AMOUNT OF USE THIS PRODUCT RECEIVES IT MAY BE NECESSARY TO TIGHTEN UP THE FIXINGS FROM TIME TO TIME. THIS IS COMPLETELY NORMAL FOR ANY FLAT PACK FURNITURE. DO NOT OVERTIGHTEN FIXINGS.

FOR CLEANING YOU MAY USE A DAMP CLOTH (NOT WET) OR DRY DUSTER .

PARTS LIST			HARDWARE LIST			
			A		Ø5/16" x 25MM BOLT	8 PCS
			B		Ø5/16" x 45MM BOLT	2 PCS
			C		Ø5/16" x 25MM PLASTIC FOOT ADJUSTER	2 PCS
			D		5MM ALLEN KEY	1 PC
			E		CENTRE PLASTIC CONNECTOR	13 PCS
			F		END CAP	26 PCS
			G		Ø1/4" x 57MM BOLT	3 PCS
			H		Ø1/4" BUTTERFLY NUT	3 PCS
1	HEADBOARD	1 PC	I		Ø1/4" x 16MM WASHER	6 PCS
2	FOOTBOARD	1 PC	J		Ø1/4" SPRING WASHER	6 PCS
3	CENTRE SUPPORT LEG	2 PCS	K		Ø1/4" x 16MM PLASTIC WASHER	3 PCS
4	FEET	4 PCS	L		4MM ALLEN KEY	1 PC
5	SIDE RAIL	2 PCS	<p>PLEASE CHECK THAT YOU HAVE ALL THE PARTS LISTED BEFORE YOU START ASSEMBLING. IF YOU DO FIND THAT SOMETHING IS MISSING, DO NOT CONTINUE ASSEMBLY. PLEASE CONTACT YOUR SUPPLIER IMMEDIATELY.</p>			
6	CENTRE RAIL	1 PC				
7	WOODEN SLAT	26 PCS				
8	CENTRE CROSS RAIL	1 PC				

USE OF POWER TOOLS TO ASSEMBLE THIS PRODUCT WILL INVALIDATE ANY CLAIM AND MAY DAMAGE THIS PRODUCT MAKING IT UNSAFE

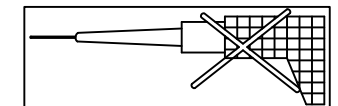

Step 1

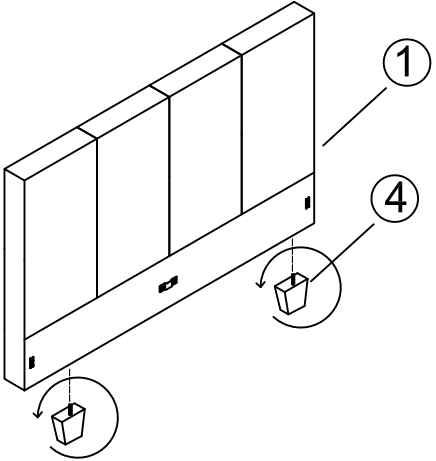

Step 2

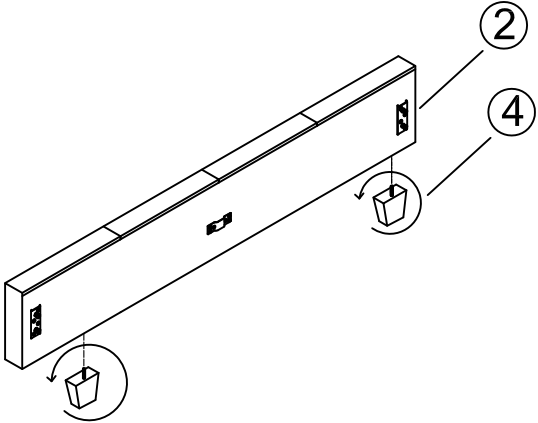

Step 3

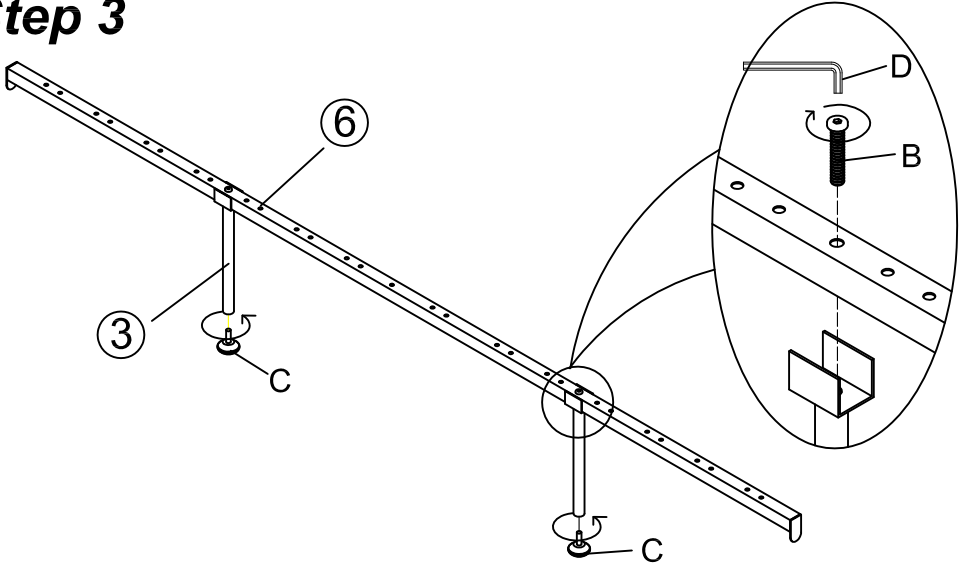

Step 4

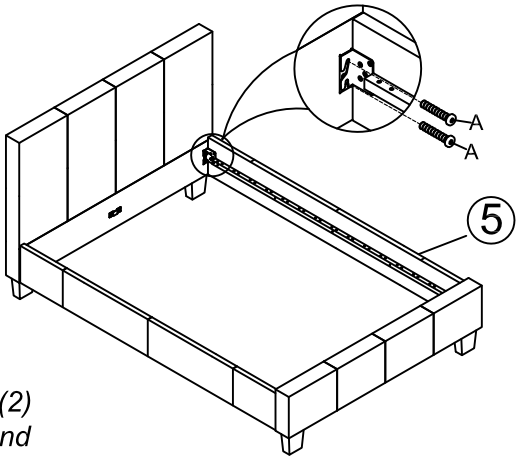

Attach the Side Rail (5) to the Headboard (1) and Footboard (2) using $\phi 5/16 \times 25\text{MM}$ Bolt (A) and securely fasten.

USE OF POWER TOOLS TO ASSEMBLE THIS PRODUCT WILL INVALIDATE ANY CLAIM AND MAY DAMAGE THIS PRODUCT MAKING IT UNSAFE

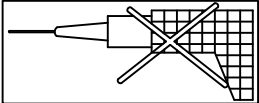

Step 5

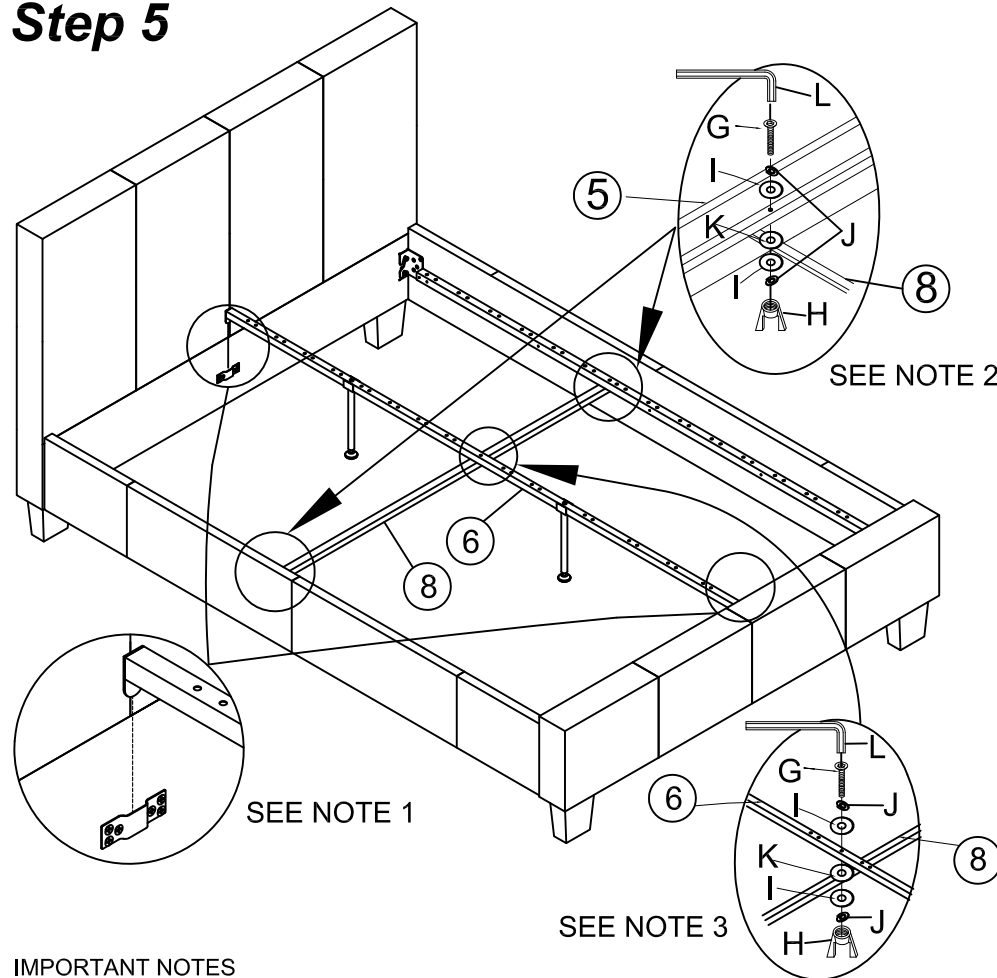

IMPORTANT NOTES

- NOTE 1 - LOCATE CENTRE RAIL (6) IN BRACKETS ON HEADBOARD (1) AND FOOTBOARD (2)
- NOTE 2 - ASSEMBLE CENTRE CROSS RAIL (8) TO SIDE RAIL (5)
- NOTE 3 - ASSEMBLE CENTRE RAIL (6) TO CENTRE CROSS RAIL (8)
- NOTE 4 - PLASTIC FOOT ADJUSTER (C) IS USED TO ADJUST THE HEIGHT OF THE CENTRE SUPPORT LEG (3) WHEN NECESSARY. IT IS RECOMMENDED TO ADJUST THE PLASTIC STUD (C) AT LEAST 5MM AWAY FROM THE FLOOR

Step 6

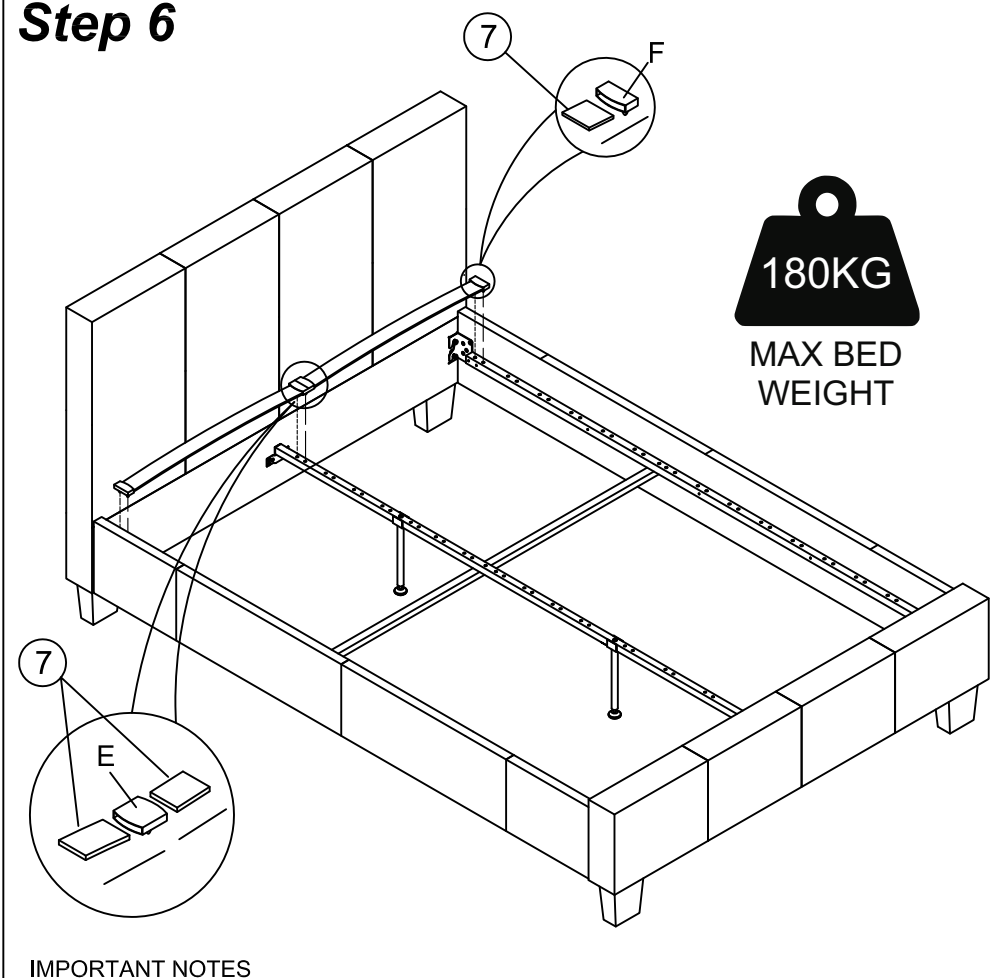

IMPORTANT NOTES

- INSERT THE CENTRE PLASTIC CONNECTOR (E) ONTO THE CENTRE RAIL (6).
- INSERT THE WOODEN SLAT (7) INTO THE CENTRE PLASTIC CONNECTOR (E) AND SLIDE IN THE END CAP (F). SECURE THE END CAP (F) ONTO THE SIDE RAIL (5).
- REPEAT THIS OPERATION UNTIL ALL SLATS ARE ASSEMBLED TO BED.
- ALWAYS REMEMBER, WHEN MOVING THE BED FOR CLEANING, ETC, LIFT THE BED WITH TWO PEOPLE. DO NOT SLIDE OR DRAG THE BED.

USE OF POWER TOOLS TO ASSEMBLE THIS PRODUCT WILL INVALIDATE ANY CLAIM AND MAY DAMAGE THIS PRODUCT MAKING IT UNSAFE

