

55927 - TB

# MAYA 4' BED ASSEMBLY INSTRUCTIONS

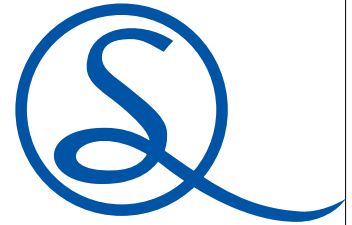
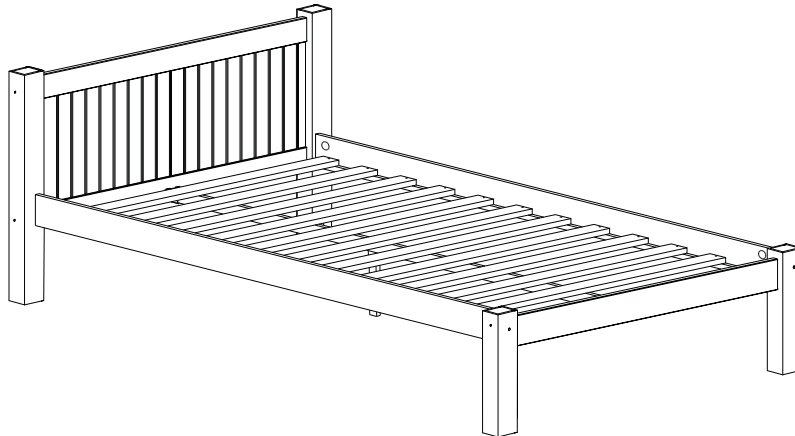
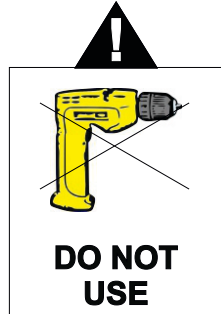

**FOR DOMESTIC USE ONLY**

**IMPORTANT**

PLEASE READ BEFORE YOU CONTINUE FURTHER

## CARE AND MAINTENANCE

After unpacking this product please keep the original packaging in case it needs to be returned for any reason.

- Please ensure all fittings and parts are present before commencing with assembly.
- We recommend that you lay a blanket or sheet on the floor to avoid damage to both your floor and the product.
- We strongly recommend that you keep children away from your work area.
- Assemble this product as close to its final position as possible.
- Never drag or push products as this could cause damage to the joints making it inferior.
- Do not place this product next to a radiator or in direct sunlight.
- Wood is a natural product and may expand if subjected to damp and may shrink or crack if subjected to heat. Therefore it is recommended that room temperature is maintained, with no sudden temperature fluctuations.
- Make sure any spillage is wiped off immediately.
- Do not place hot or chilled items directly on to the surface, use a place mat or marking will occur.
- For general cleaning use a duster, and do not use detergents of any kind. However, the surface will need to be retreated from time to time. This can be done by using block wax (unperfumed) and rubbing it over the whole item.
- From time to time it may be necessary to tighten fittings, regular inspections should be carried out.

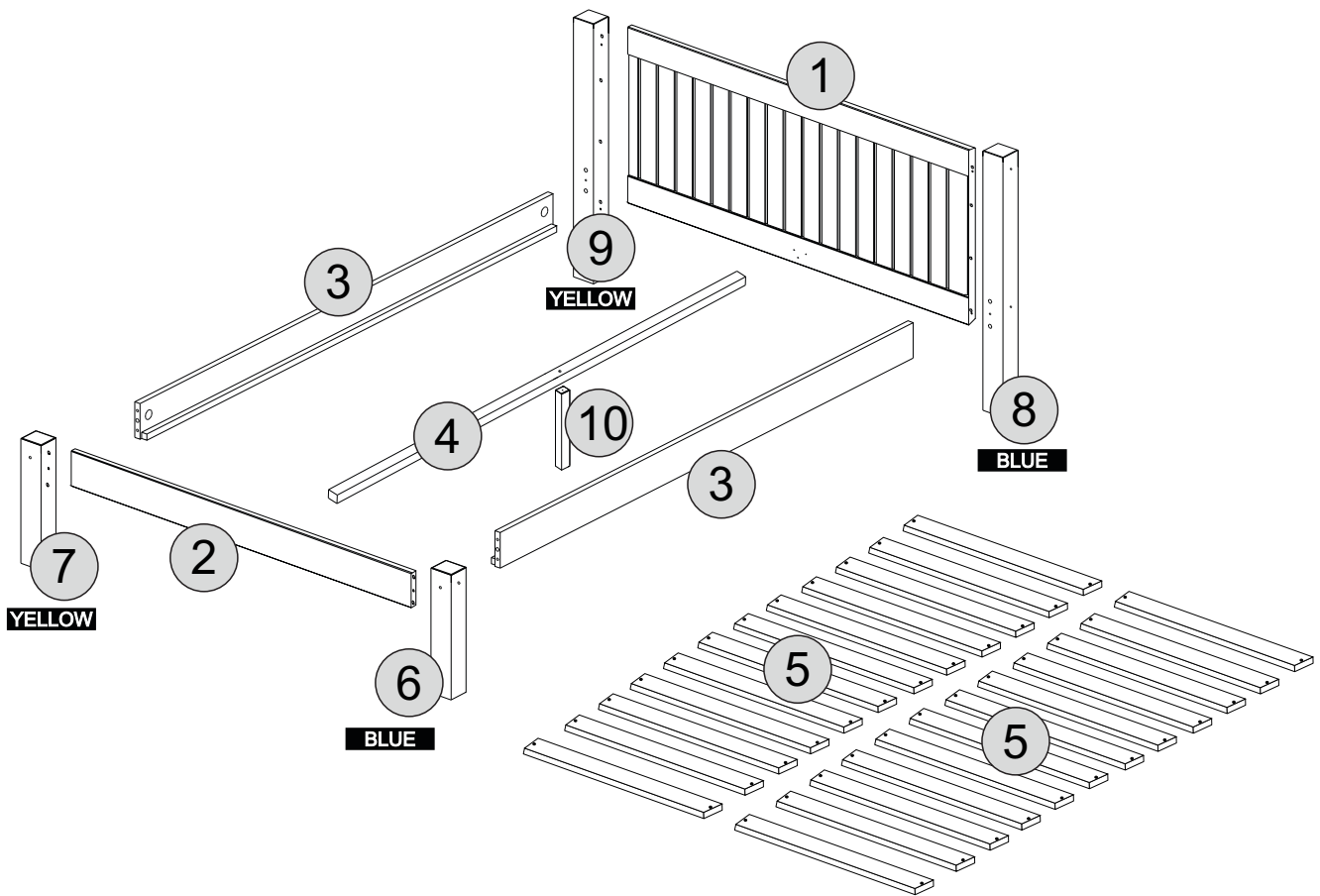









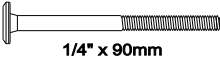

**!**  
 \* Use of power tools to assemble this product will invalidate any claim and damage this product making it unsafe !!!  
 \* Please assemble on a clean soft surface to avoid damage.

**!**  
 \* Please check contents and read the instructions before commencing assembly.  
 \* Assemble this product following the enclosed instructions carefully.  
 \* Please take care to avoid damaging panels during assembly.

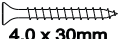
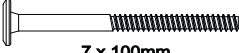
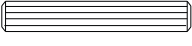
### PARTS LIST

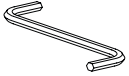
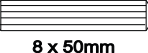
Part Number	Part Code	Part Description	Quantity	Carton
1	S200-202-010-TB1-01	Headboard	1	1/2
2	S200-202-010-TB1-02	Footboard	1	1/2
3	S200-202-010-TB1-03	Siderail	2	2/2
4	S200-202-010-TB1-04	Centre Support Rail	1	2/2
5	S200-202-010-TB1-05	Slat	24	1/2
6	S200-202-010-TB1-06	Right Footboard Post	1	1/2
7	S200-202-010-TB1-07	Left Footboard Post	1	1/2
8	S200-202-010-TB1-08	Right Headboard Post	1	1/2
9	S200-202-010-TB1-09	Left Headboard Post	1	1/2
10	S200-202-010-TB1-10	Centre Support Leg	1	2/2

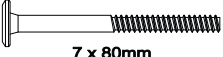
## FITTINGS

<b>A</b>	 1/4" x 90mm	<b>04</b>	<b>H</b>	 Phillips 4,0 x 20	<b>04</b>
<b>B</b>		<b>04</b>	<b>I</b>		<b>02</b>
<b>C</b>	 4.0 x 30mm	<b>48</b>	<b>J</b>	 7 x 100mm	<b>06</b>
<b>D</b>	 10 x 50mm	<b>08</b>	<b>K</b>	 GLUE	<b>01</b>
<b>E</b>		<b>01</b>	<b>L</b>	 8 x 50mm	<b>12</b>
<b>F</b>	(SPACER) (WOODEN) 	<b>02</b>	<b>M</b>	 7 x 80mm	<b>01</b>
<b>G</b>	 4.0 x 16mm	<b>08</b>			

## TOOLS REQUIRED

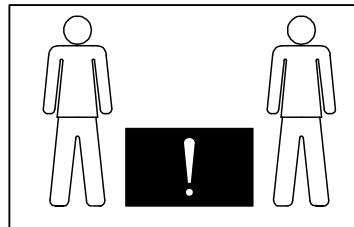
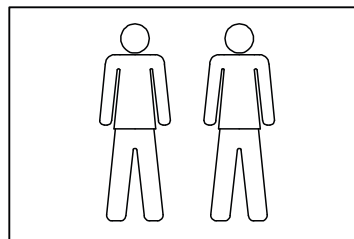
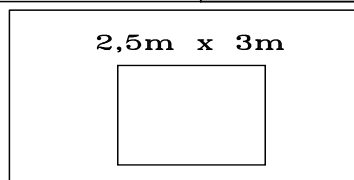
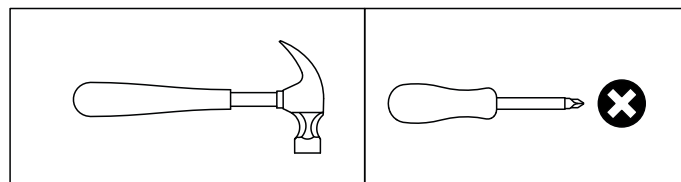



# STEP 1

## PARTS REQUIRED

- 1 - HEADBOARD x1
- 8 - RIGHT HEADBOARD POST x1
- 9 - LEFT HEADBOARD POST x1

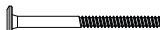
## HARDWARE REQUIRED

- J  04
- K  01
- L  08

## TOOLS REQUIRED

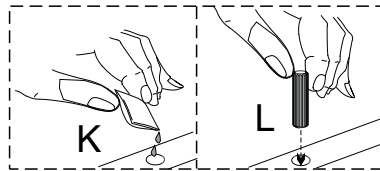
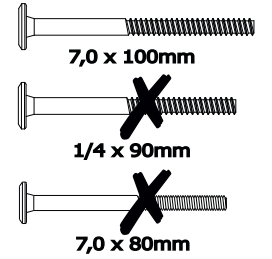
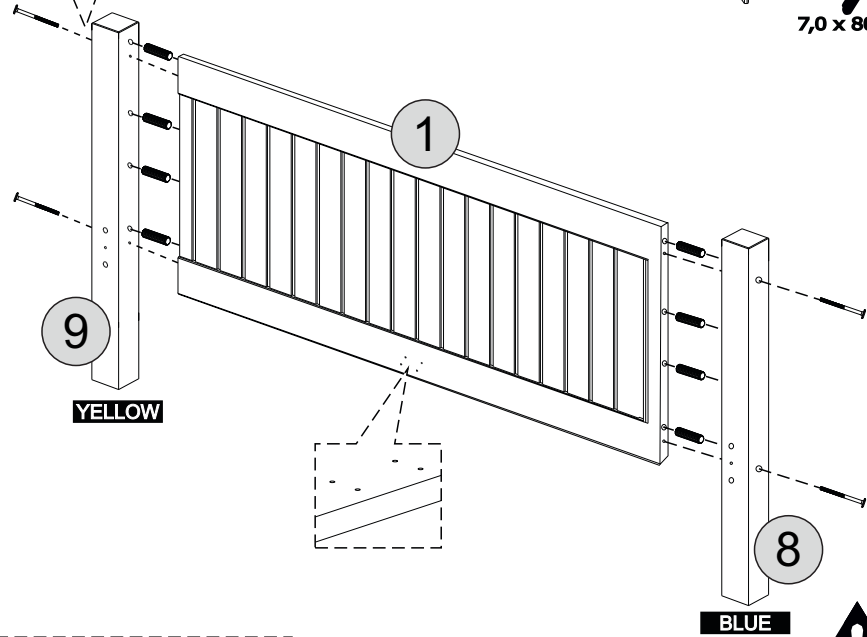
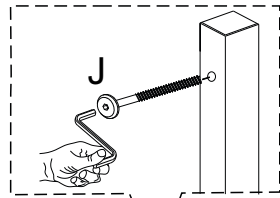
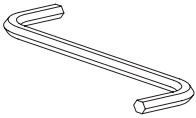



**Glue must be added to the dowel holes on parts 1, 8 and 9.**

# STEP 2

## PARTS REQUIRED

- 2 - FOOTBOARD x1
- 6 - LEFT FOOTBOARD POST x1
- 7- RIGHT FOOTBOARD POST x1

## HARDWARE REQUIRED

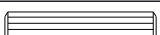
- J  02
- K  01
- L  04

## TOOLS REQUIRED

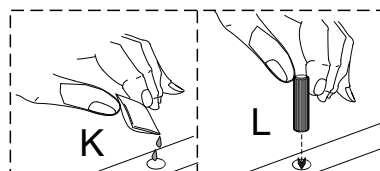
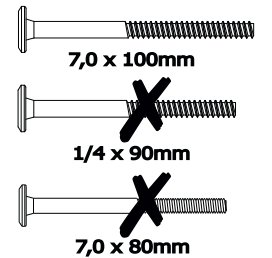
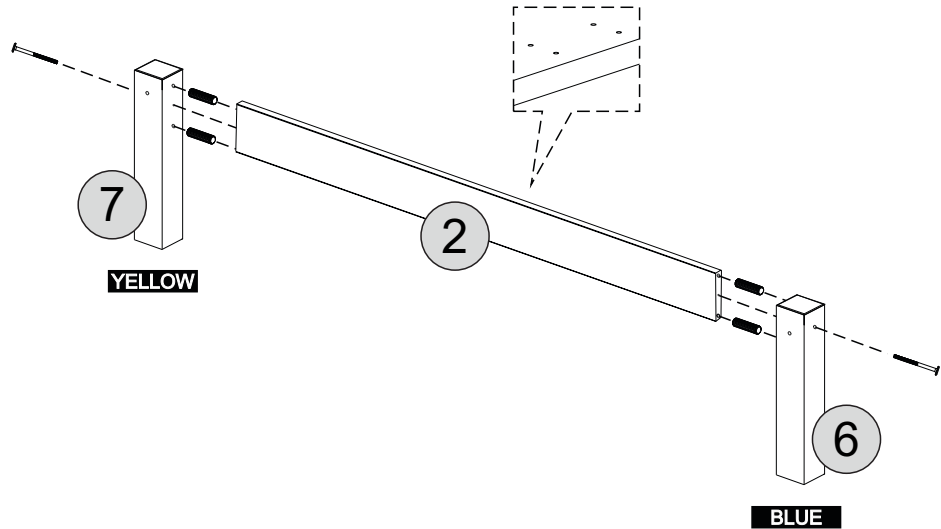
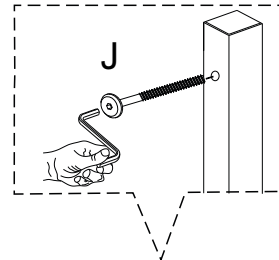
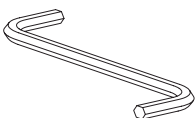

**Glue must be added to the dowel holes on parts 2, 6 and 7.**

# STEP 3

## PARTS REQUIRED

3 - SIDERAIL x2

## HARDWARE REQUIRED

D  08

K  01

## TOOLS REQUIRED

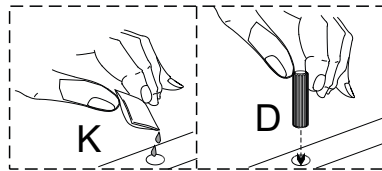
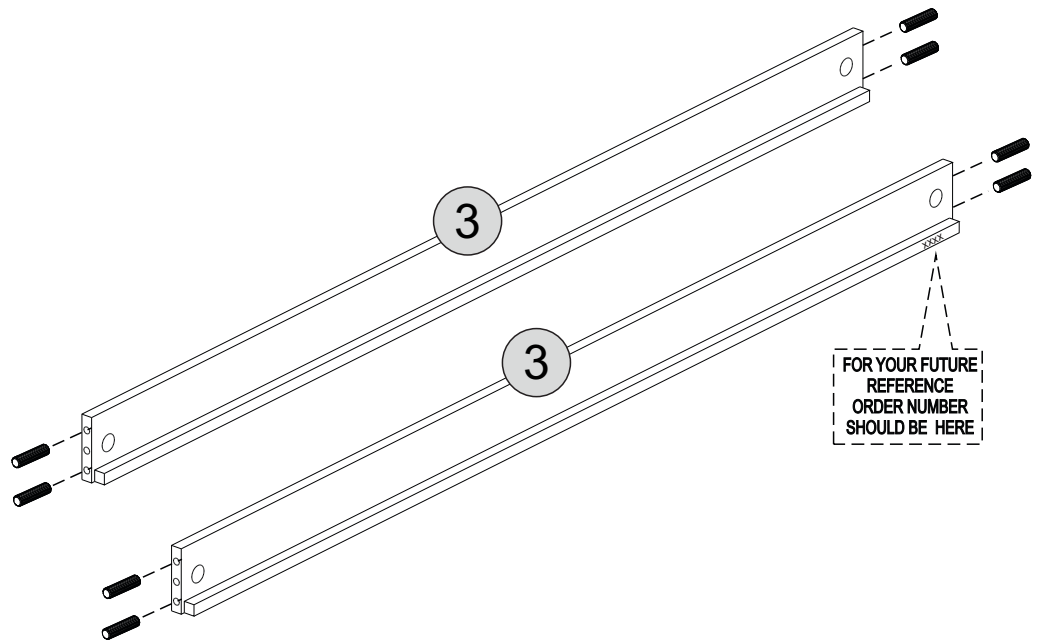

  
**Glue must be added to the dowel holes on part 3.**

# STEP 4

## PARTS REQUIRED

3 - SIDERAIL x2

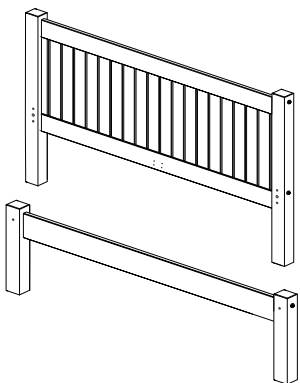

## HARDWARE REQUIRED

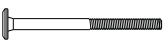
A  04

B  04

## TOOLS REQUIRED

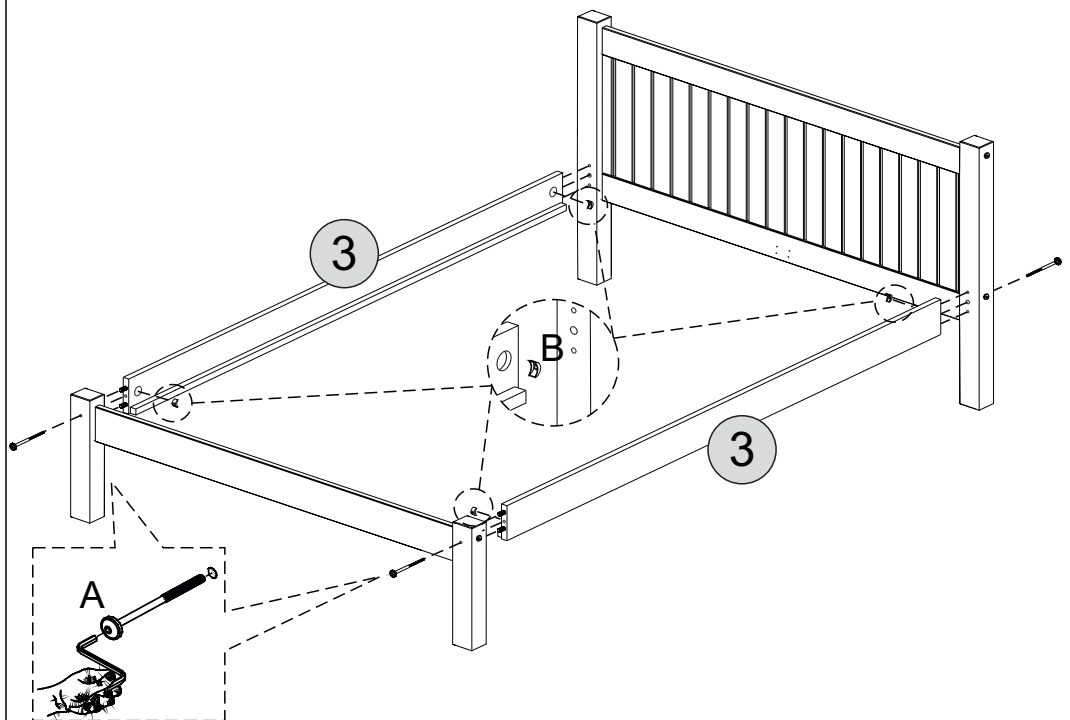
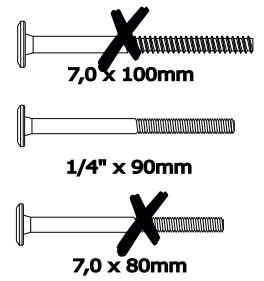
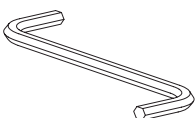

# STEP 5

## PARTS REQUIRED

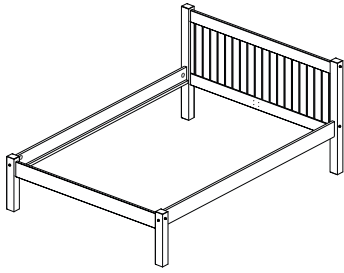

## HARDWARE REQUIRED

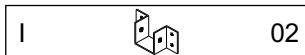

## TOOLS REQUIRED

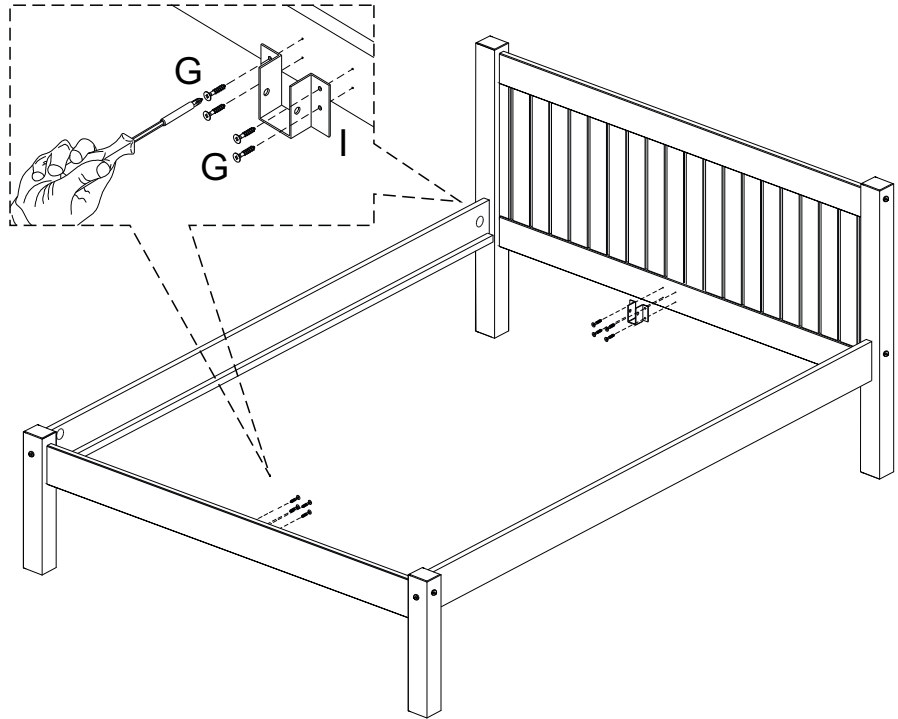
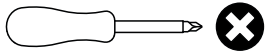

# STEP 6

## PARTS REQUIRED

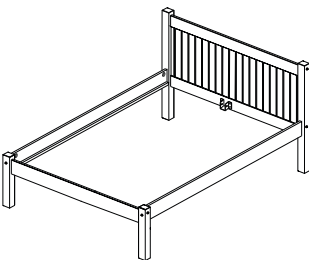

## HARDWARE REQUIRED

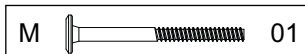
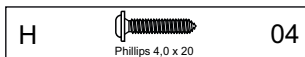

## TOOLS REQUIRED

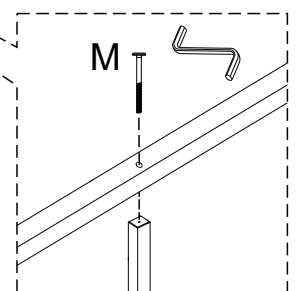
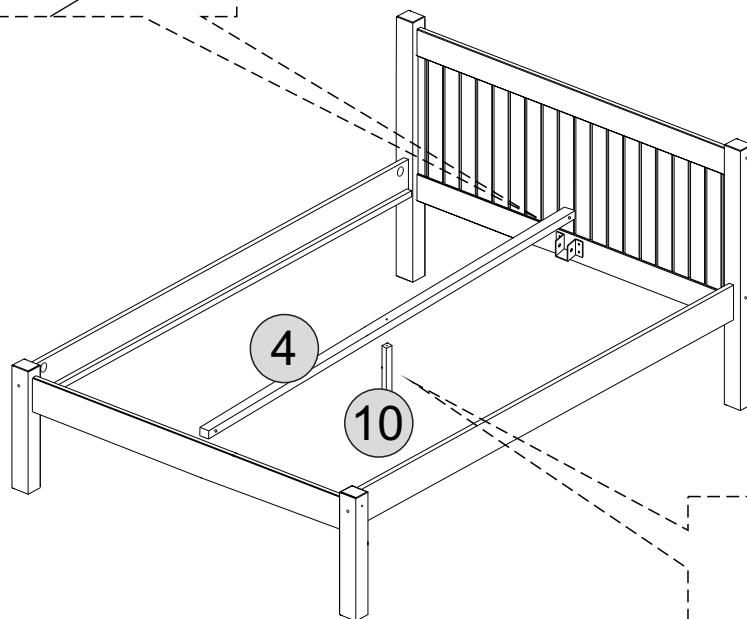
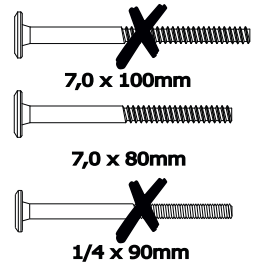
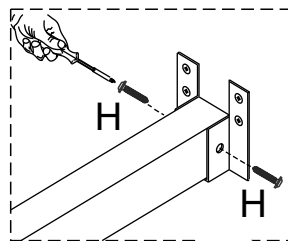
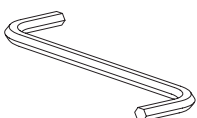

# STEP 7

**PARTS REQUIRED**

5 - SLAT x24

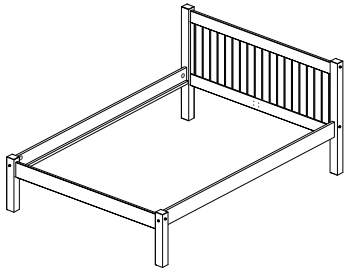

**HARDWARE REQUIRED**

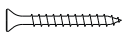
C  48

F  02

**TOOLS REQUIRED**

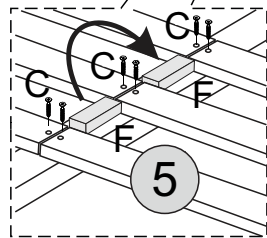
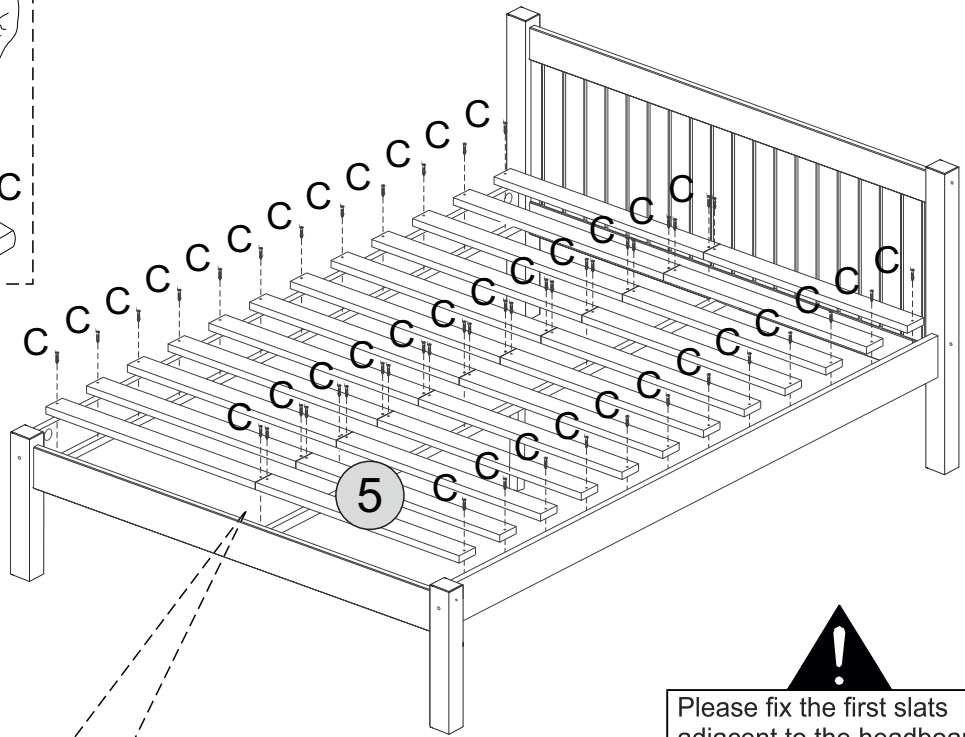
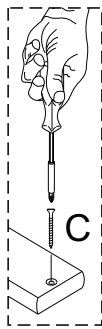
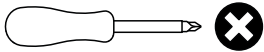

Please fix the first slats adjacent to the headboard and footboard and work towards the middle of the bed using the spacer ( F ) as shown to ensure correct spacing. Fix all the slats to one siderail first then push the second siderail tight against the slats and fix.

# STEP 8

**PARTS REQUIRED**

**HARDWARE REQUIRED**

**TOOLS REQUIRED**



**180KG**  
**MAX BED WEIGHT**

