

KELLY 4'6" BED ASSEMBLY INSTRUCTIONS

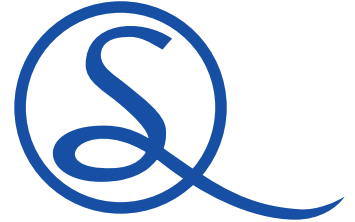
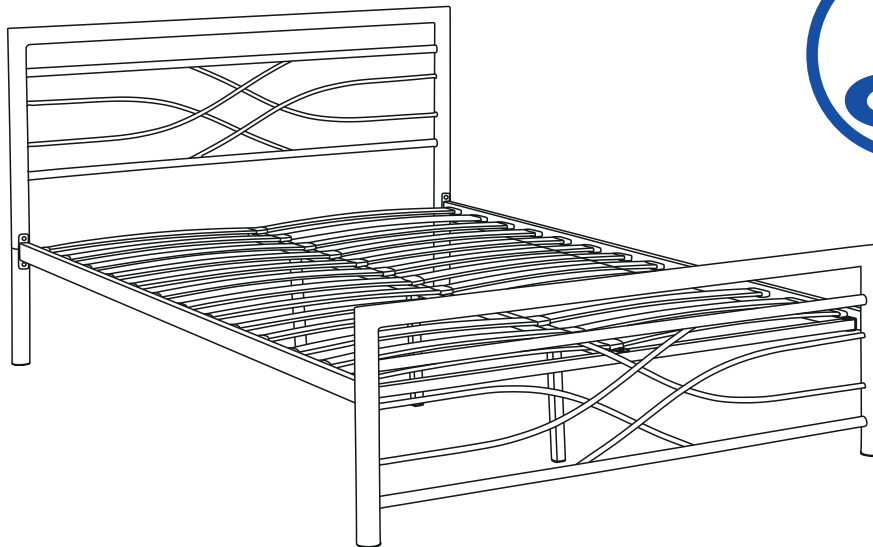
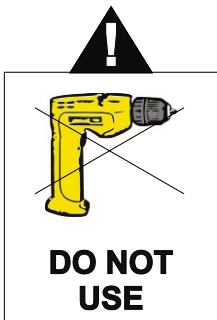

IMPORTANT FOR DOMESTIC USE ONLY PLEASE READ BEFORE YOU CONTINUE FURTHER

THE PRODUCT YOU HAVE PURCHASED WILL GIVE YOU MANY YEARS OF SERVICE IF YOU FOLLOW THE GUIDELINES FOR ITS SAFE ASSEMBLY AND PERIODIC MAINTENANCE AND CLEANING.

DO NOT USE ANY TOOLS OTHER THAN THOSE SHOWN.

ANY SPANNERS OR ALLEN KEYS REQUIRED ARE INCLUDED WITH THE FITTINGS KIT.

DO NOT FOR ANY REASON USE A POWER TOOL TO ASSEMBLE THIS PRODUCT. ITS USE WILL INVALIDATE ANY CLAIM YOU MAY HAVE AND COULD MAKE THIS PRODUCT UNSAFE .

DEPENDING ON THE AMOUNT OF USE THIS PRODUCT RECEIVES IT MAY BE NECESSARY TO TO TIGHTEN UP THE FIXINGS FROM TIME TO TIME, THIS IS COMPLETELY NORMAL FOR ANY FLATPACK FURNITURE.



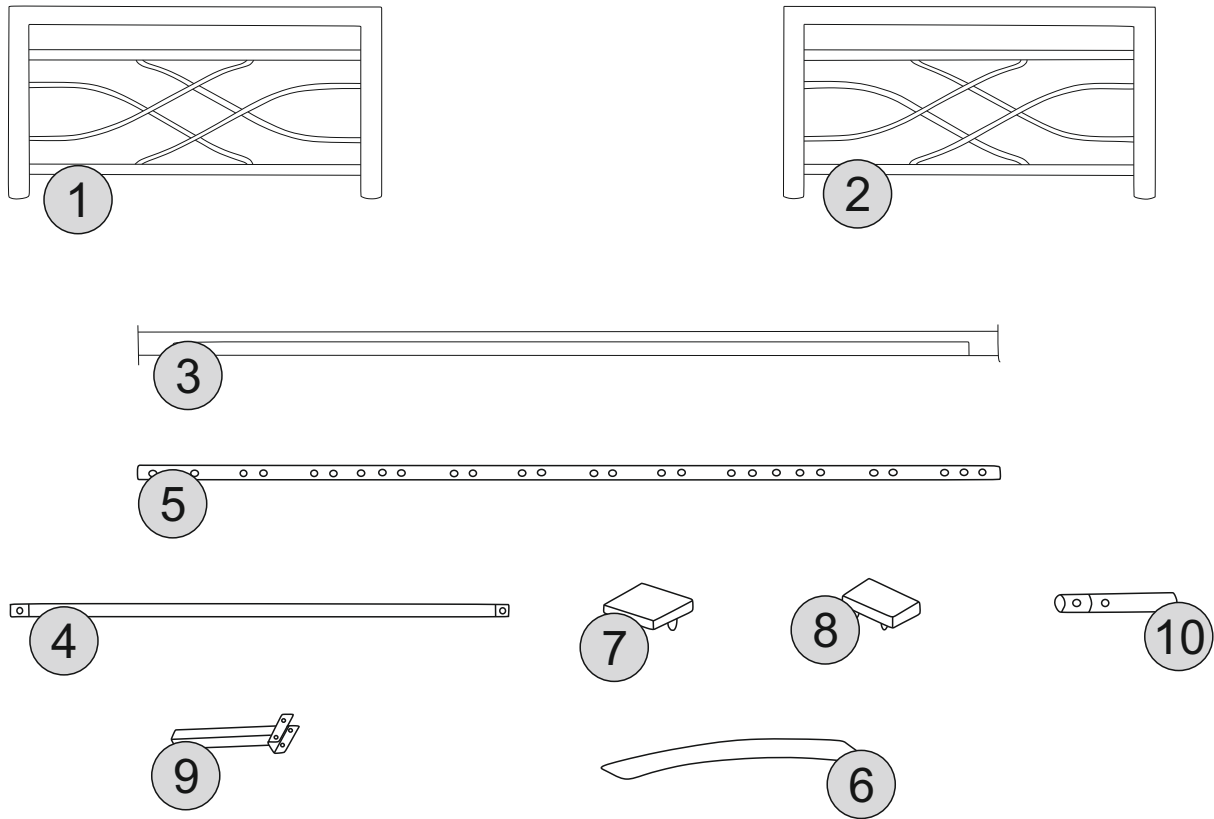





FOR CLEANING, YOU MAY USE A DAMP CLOTH (NOT WET) DO NOT USE POLISH, DETERGENT OR CHEMICAL CLEANERS.



PARTS LIST

Part Number	Part Code	Part Description	Quantity	Carton
1	S200-203-020-WJ1-01	Headboard	1	1
2	S200-203-020-WJ1-02	Footboard	1	1
3	S200-203-020-WJ1-03	Siderail	2	2
4	S200-203-020-WJ1-04	Crossbar	2	2
5	S200-203-020-WJ1-05	Centre Rail	1	2
6	S200-203-020-WJ1-06	Wooden Slat	26	1
7	S200-203-020-WJ1-07	Centre Slat Cap	13	1
8	S200-203-020-WJ1-08	Slat Cap	26	1
9	S200-203-020-WJ1-09	Support Leg	3	1
10	S200-203-020-WJ1-10	Leg Extension	2	1

HARDWARE LIST

No	Part Name		Qty	Carton
A	M6 x 15MM BOLTS		x10	1/1
B	M6 x 45MM BOLTS		x4	1/1
C	M6 x 38MM BOLTS		x6	1/1
D	M6 INSERT NUTS		x4	1/1
E	NUT		x6	1/1
F	METAL WASHER		x4	1/1
G	M4 ALLEN KEY		x2	1/1
H	M4 SPANNER		x1	1/1

PLEASE CHECK THAT YOU HAVE ALL THE PARTS LISTED BEFORE YOU START ASSEMBLING, IF YOU DO FIND THAT SOMETHING IS MISSING, DO NOT CONTINUE ASSEMBLY. PLEASE CONTACT YOUR SUPPLIER IMMEDIATELY.

STEP 1

PARTS REQUIRED

3 - SIDERAIL x2

4 - CROSSBAR x2

HARDWARE REQUIRED

A  04
M6x15mm

TOOLS REQUIRED

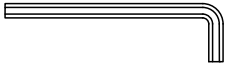

~~M6x45mm~~



~~M6x38mm~~

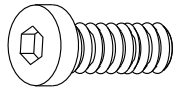

M6x15mm

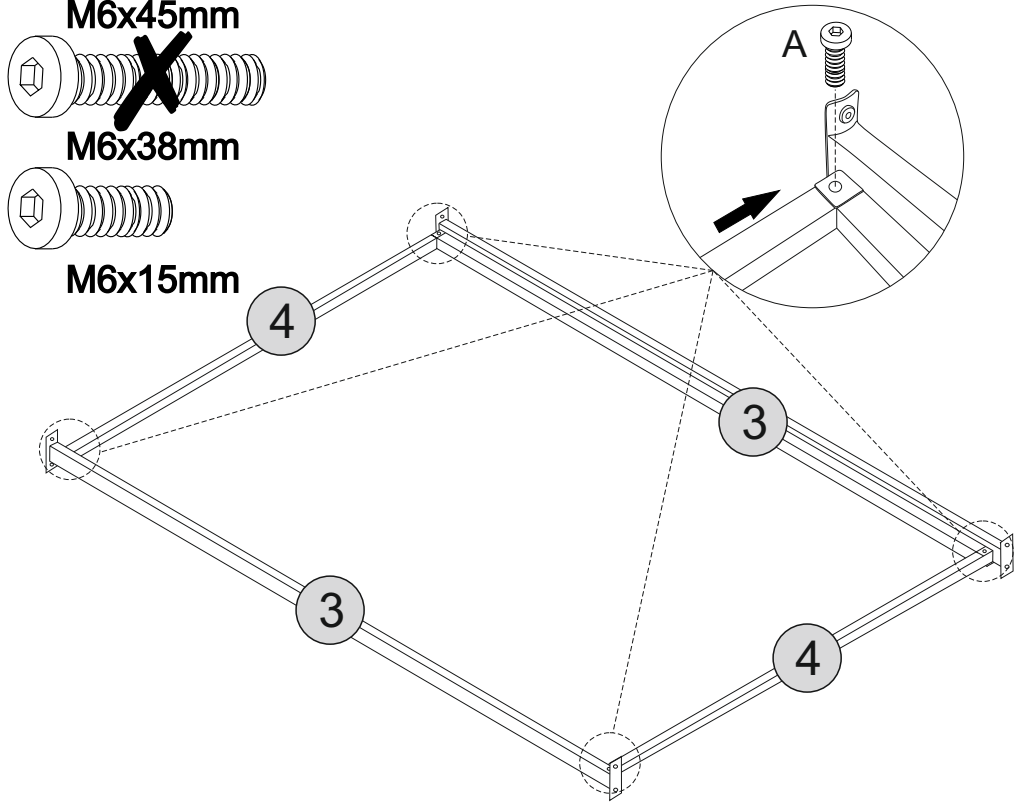

STEP 2

PARTS REQUIRED

1 - HEADBOARD x1

2 - FOOTBOARD x1

10 - LEG EXTENSION x2

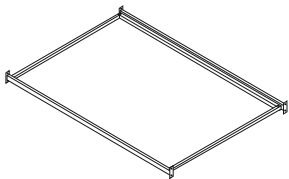

HARDWARE REQUIRED

A  04
M6x15mm

B  04
M6x45mm

D  04

F  04

TOOLS REQUIRED

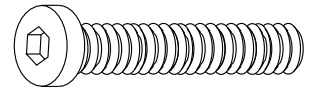
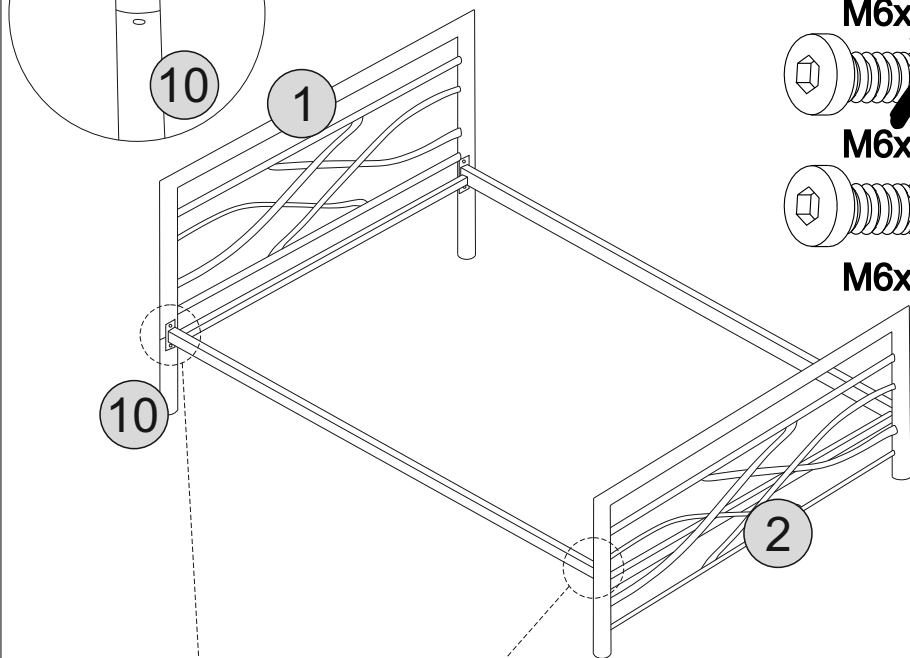
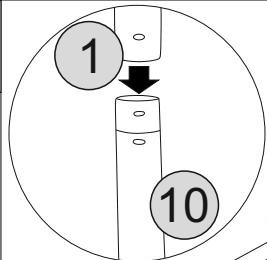

M6x45mm

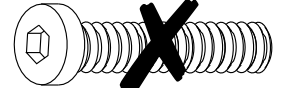

~~M6x38mm~~

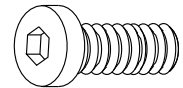

M6x15mm

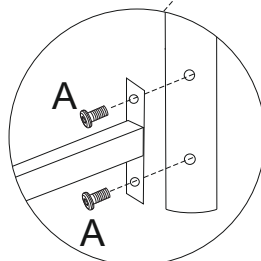
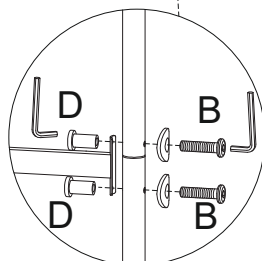

STEP 3

PARTS REQUIRED

5 - CENTRE RAIL x1

9 - SUPPORT LEG x3

HARDWARE REQUIRED

A  02
M6x15mm

C  06
M6x38mm

E  06

TOOLS REQUIRED

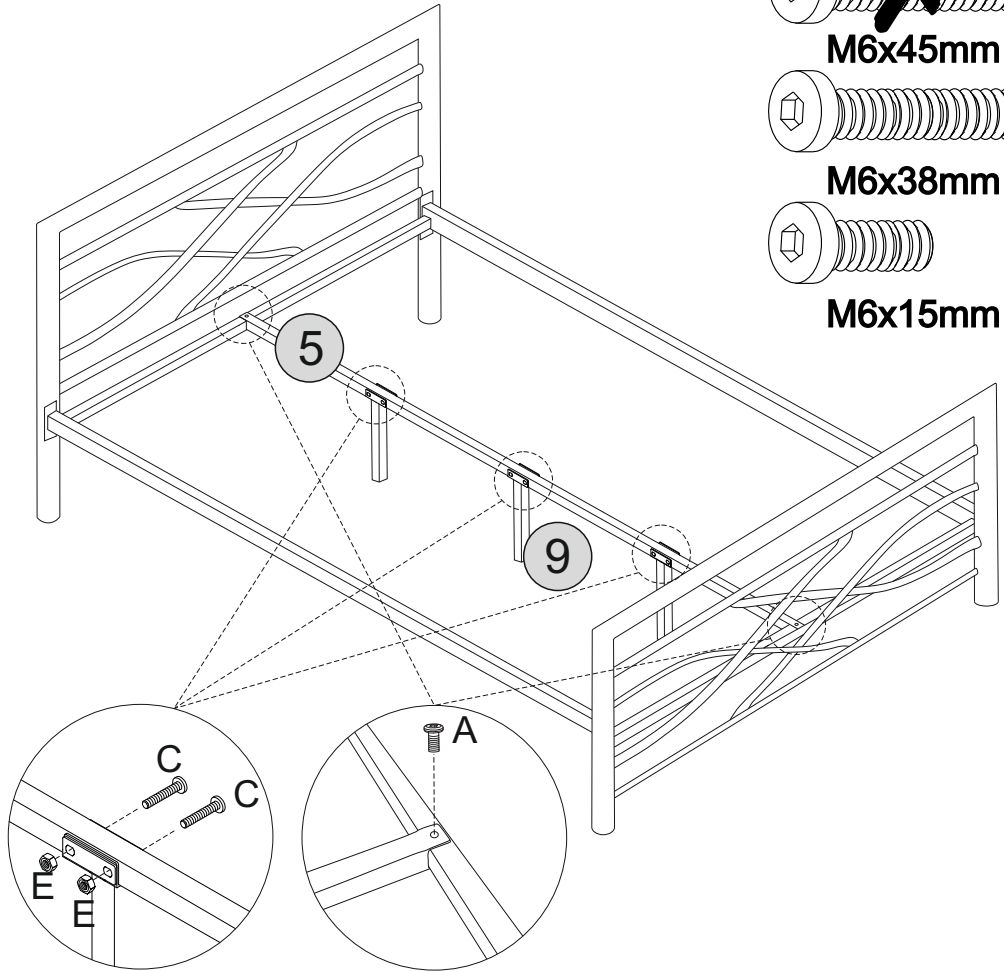
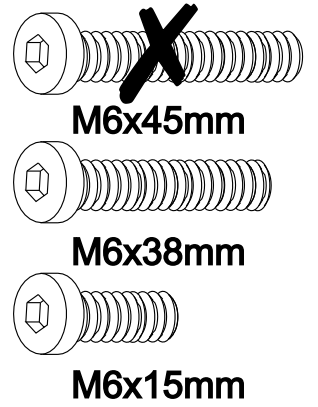
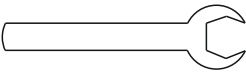

STEP 4

PARTS REQUIRED

6 - WOODEN SLAT x26

7 - CENTRE SLAT CAP x13

8 - SLAT CAP x26

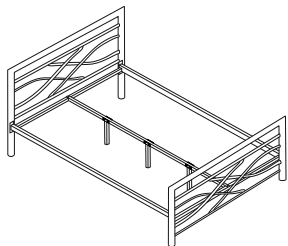

HARDWARE REQUIRED

TOOLS REQUIRED

