

# HARLOW 4'6" BED SILVER ASSEMBLY INSTRUCTIONS

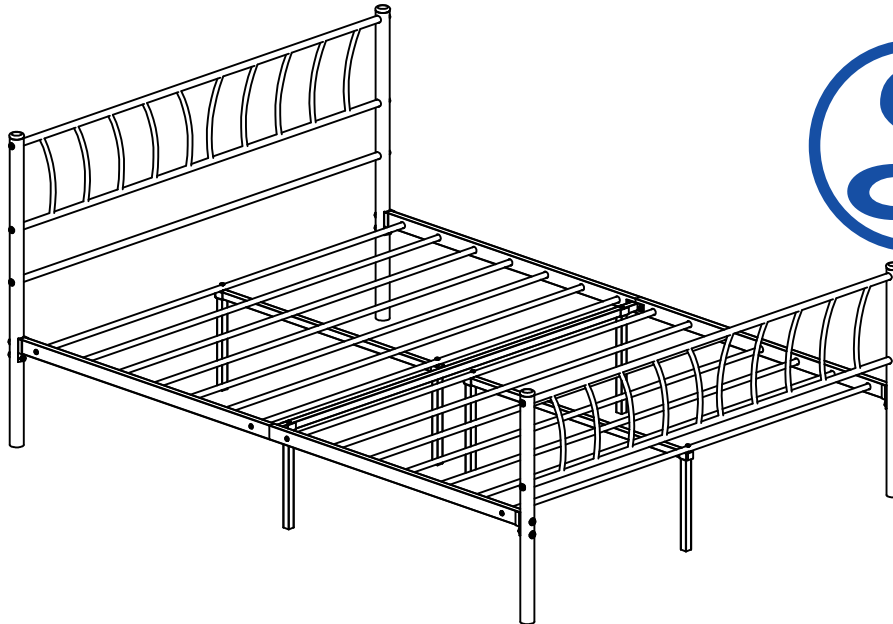

FOR DOMESTIC USE ONLY  
IMPORTANT

PLEASE READ BEFORE YOU CONTINUE FURTHER

THE PRODUCTS YOU HAVE PURCHASED WILL GIVE YOU MANY YEARS OF SERVICE IF YOU FOLLOW THE GUIDELINES FOR ITS SAFE ASSEMBLY AND PERIODIC MAINTENANCE AND CLEANING.

ASSEMBLE ON A SOFT CLEAN SURFACE.

DO NOT USE ANY TOOLS OTHER THAN THOSE SHOWN.

ANY SPANNERS AND ALLEN KEYS REQUIRED ARE INCLUDED WITH THE FITTINGS KIT.

DO NOT FOR ANY REASON USE POWER TOOLS TO ASSEMBLY THIS PRODUCT. ITS USE WILL INVALIDATE ANY CLAIM AND MAY DAMAGE THIS PRODUCT MAKING IT UNSAFE.

DEPENDING ON THE AMOUNT OF USE THIS PRODUCT RECEIVES IT MAY BE NECESSARY TO TIGHTEN UP THE FIXINGS FROM TIME TO TIME.  
DO NOT OVERTIGHTEN FIXINGS.

FOR CLEANING, YOU MAY USE A DAMP CLOTH (NOT WET) DO NOT USE POLISH, DETERGENT OR CHEMICAL CLEANERS.

THE SURFACE OF THIS ITEM IS NOT HEAT RESISTANT. ALWAYS USE A PLACE MAT UNDER HOT OR COLD ITEMS TO PREVENT MARKING.

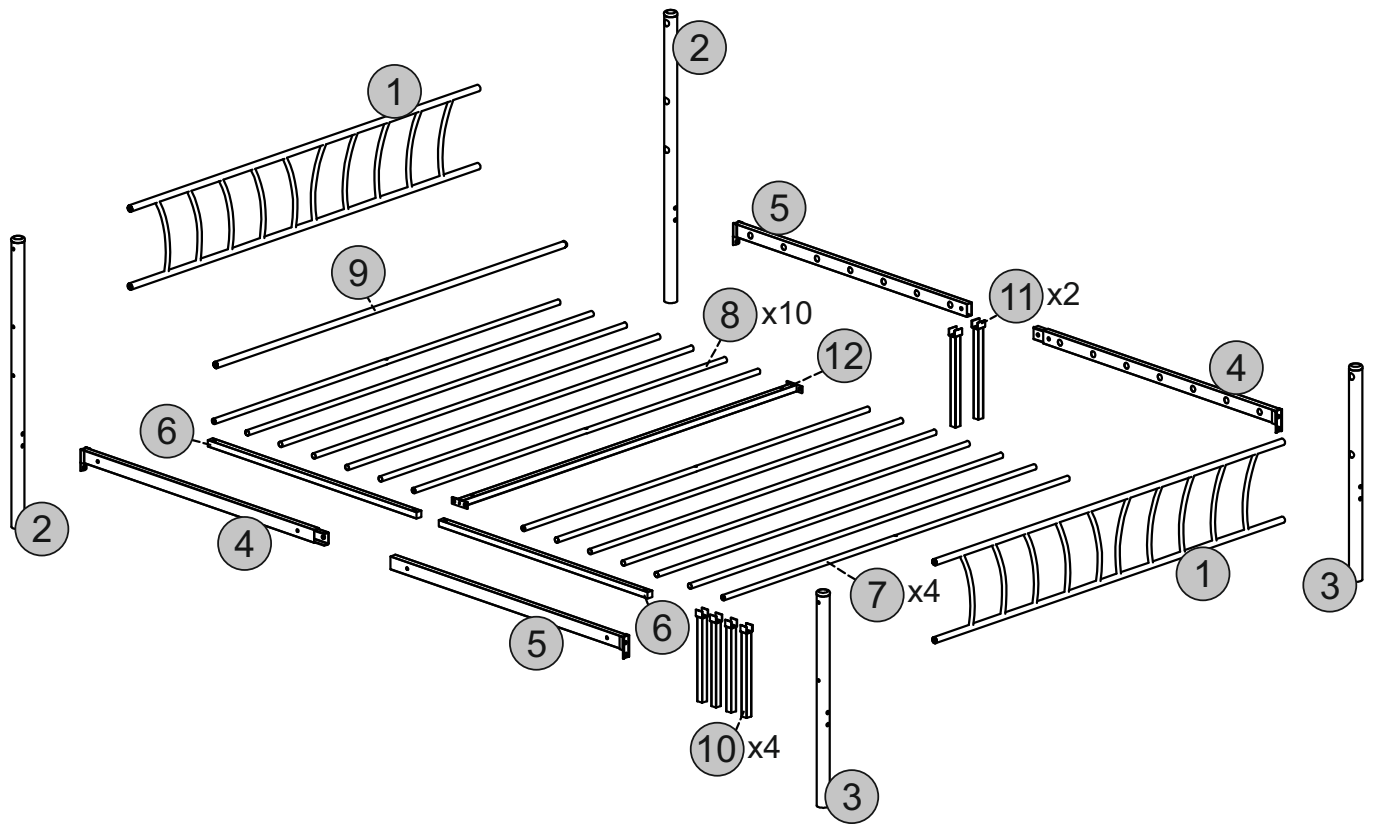









PLEASE CHECK THAT YOU HAVE ALL THE PARTS LISTED BEFORE YOU START ASSEMBLING. IF YOU DO FIND THAT SOMETHING IS MISSING, DO NOT CONTINUE ASSEMBLY. PLEASE CONTACT YOUR SUPPLIER IMMEDIATELY.

## PARTS LIST

Part Number	Part Code	Part Description	Quantity	Carton
1	S200-203-121-RJ1-01	Headboard/Footboard	2	1
2	S200-203-121-RJ1-02	Headboard Post	2	1
3	S200-203-121-RJ1-03	Footboard Post	2	1
4	S200-203-121-RJ1-04	Siderail A	2	1
5	S200-203-121-RJ1-05	Siderail B	2	1
6	S200-203-121-RJ1-06	Centre Crossbar	2	1
7	S200-203-121-RJ1-07	Crossbar A	4	1
8	S200-203-121-RJ1-08	Crossbar B	10	1
9	S200-203-121-RJ1-09	Headboard Crossbar	1	1
10	S200-203-121-RJ1-10	Centre Support Leg	4	1
11	S200-203-121-RJ1-11	Side Support Leg	2	1
12	S200-203-121-RJ1-12	Centre Support Bar	1	1

## **HARDWARE LIST**

REF		HARDWARE NAME	QTY
A		M6 x 15mm Bolt	22PCS
B		M6 x 30mm Bolt	2PCS
C		M6 x 45mm Bolt	4PCS
D		M8 x 50mm Bolt	8PCS
E		M8 Nut	4PCS
F		M8 Washer	8PCS
G		M6 Washer	10PCS
H		Allen Key	2PC
I		Spanner	1PC



**PLEASE CHECK THAT YOU HAVE ALL THE PARTS LISTED BEFORE YOU START ASSEMBLING. IF YOU DO FIND THAT SOMETHING IS MISSING, DO NOT CONTINUE ASSEMBLY. PLEASE CONTACT YOUR SUPPLIER IMMEDIATELY.**

# STEP 1

## PARTS REQUIRED





1 - HEADBOARD	x1
2 - HEADBOARD POST	x2
9 - HEADBOARD CROSSBAR	x1

## HARDWARE REQUIRED

A		06
G		06

## TOOLS REQUIRED



-  M6x15mm
- ~~~~ M6x30mm
- ~~~~ M6x45mm
- ~~~~ M8x50mm

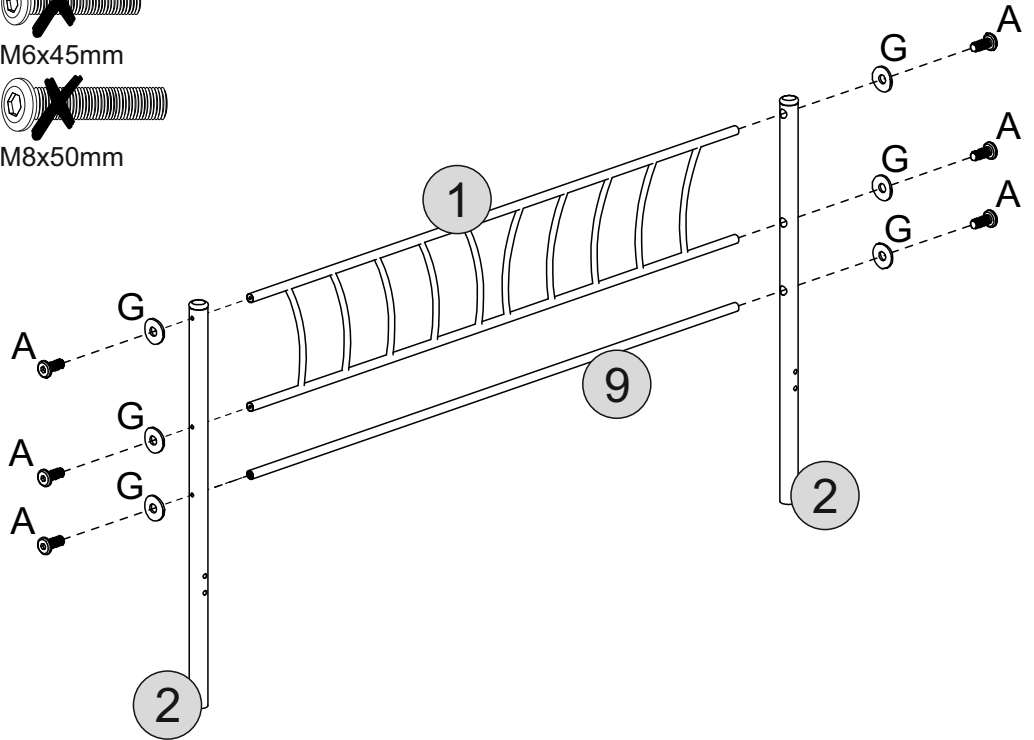



# STEP 2

## PARTS REQUIRED





1 - FOOTBOARD	x1
3 - FOOTBOARD POST	x2

## HARDWARE REQUIRED

A		04
G		04

## TOOLS REQUIRED



-  M6x15mm
- ~~~~ M6x30mm
- ~~~~ M6x45mm
- ~~~~ M8x50mm

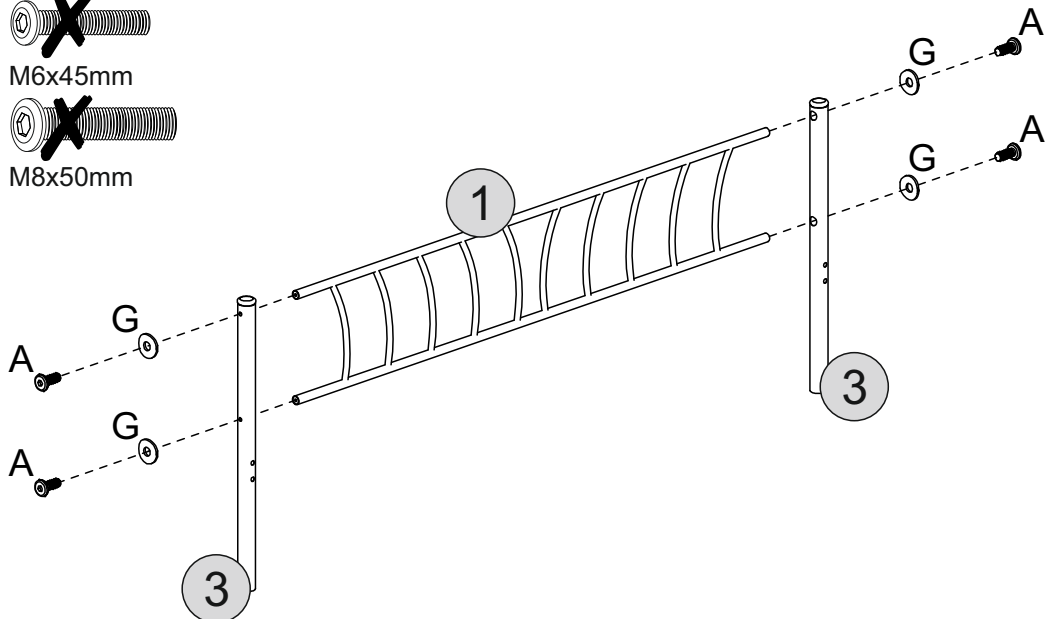

# STEP 3

## PARTS REQUIRED

4 - SIDERAIL A	x2
5 - SIDERAIL B	x2
7 - CROSSBAR A	x4
8 - CROSSBAR B	x10

## HARDWARE REQUIRED

A		08
---	---	----

## TOOLS REQUIRED

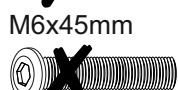

M6x15mm

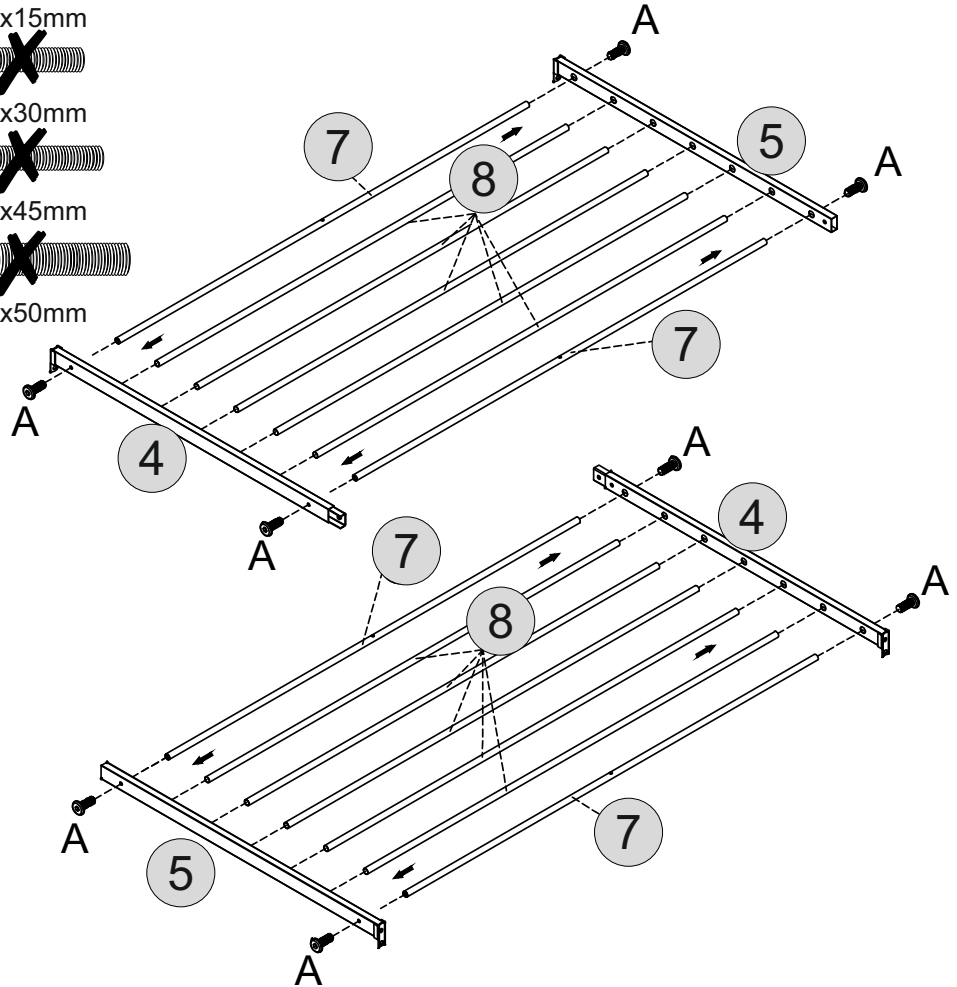

# STEP 4

## PARTS REQUIRED

12 - CENTRE SUPPORT BAR	x1
-------------------------	----

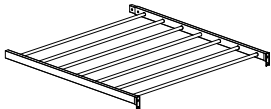
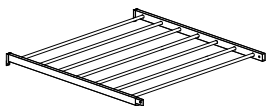

## HARDWARE REQUIRED

A		04
---	---	----

## TOOLS REQUIRED

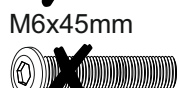

M6x15mm

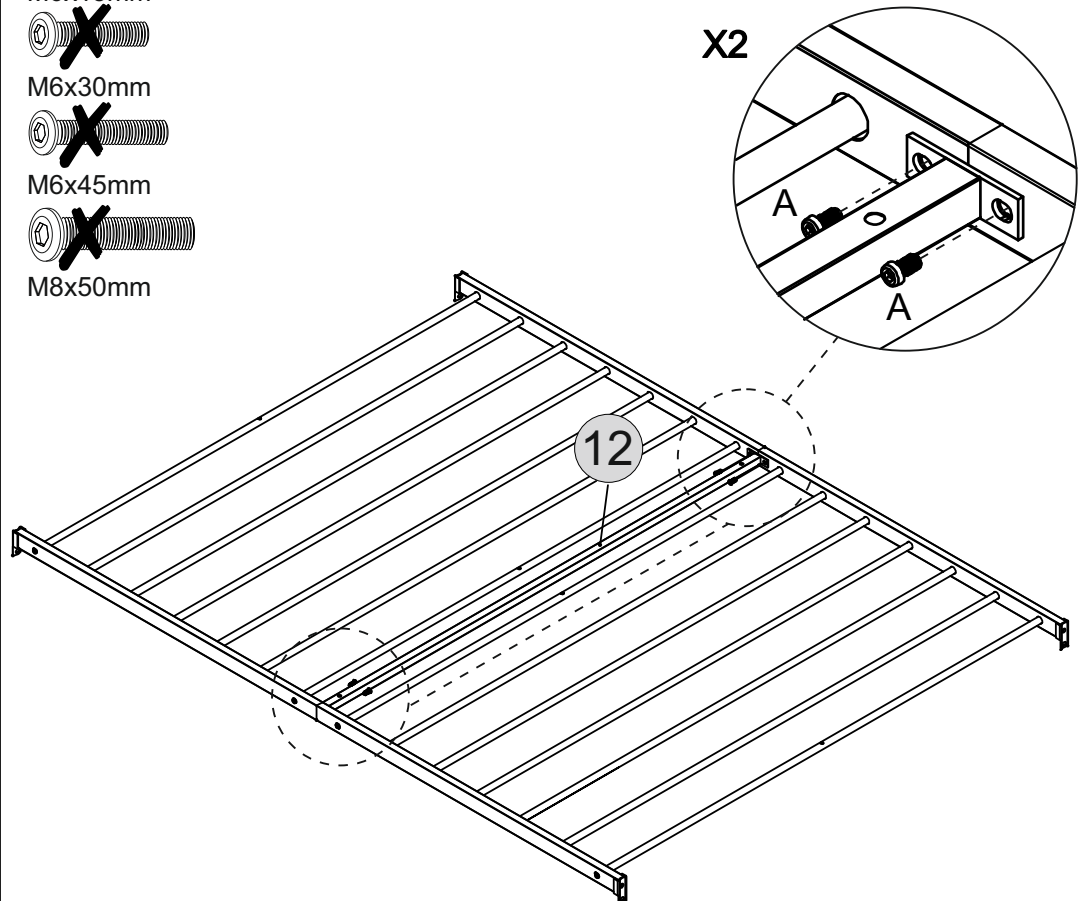

# STEP 5

## PARTS REQUIRED

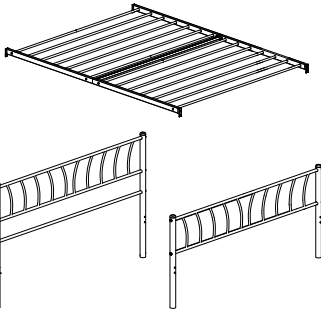

## HARDWARE REQUIRED

D		08
E		04
F		08

## TOOLS REQUIRED

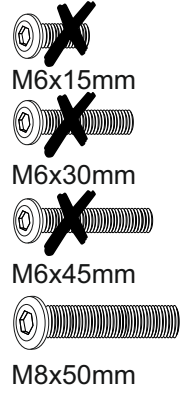
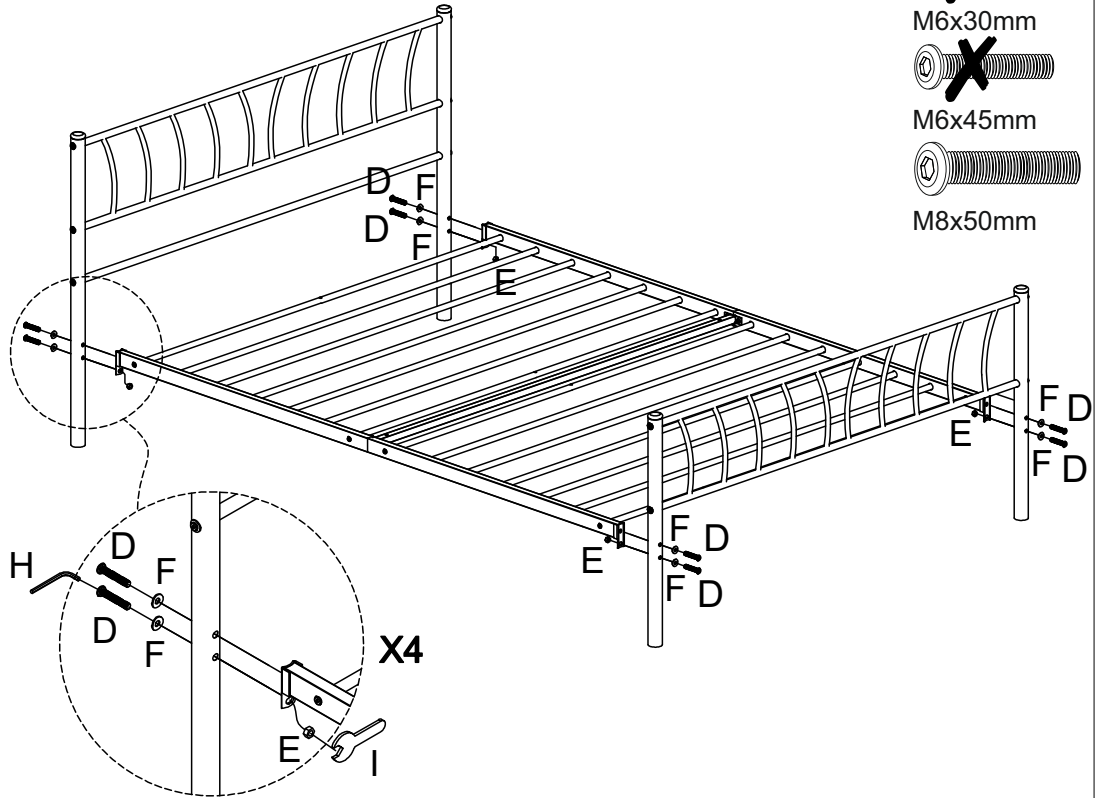
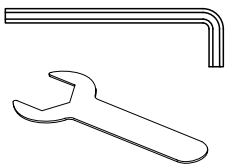

# STEP 6

## PARTS REQUIRED

6- CENTRE CROSSBAR	x2
10- CENTRE SUPPORT LEG	x4
11- SIDE SUPPORT LEG	x2

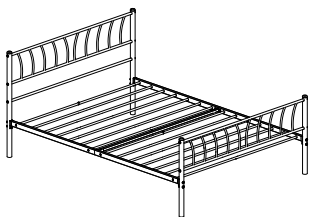

## HARDWARE REQUIRED

B		02
C		04

## TOOLS REQUIRED

