

# YORK 5' BED ASSEMBLY INSTRUCTIONS

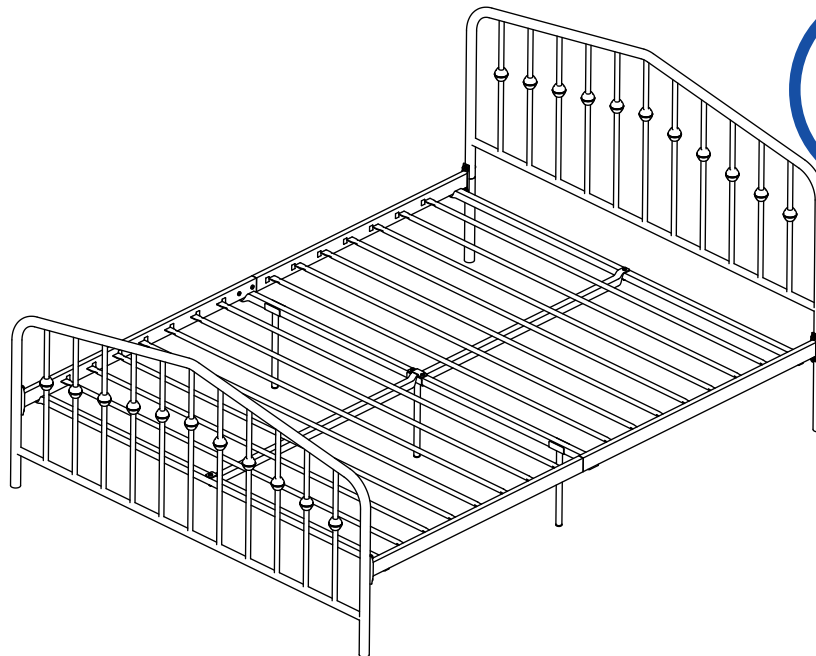
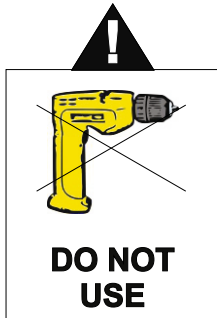

## FOR DOMESTIC USE ONLY **IMPORTANT**

### PLEASE READ BEFORE YOU CONTINUE FURTHER

THE PRODUCT YOU HAVE PURCHASED WILL GIVE YOU MANY YEARS OF SERVICE IF YOU FOLLOW THE GUIDELINES FOR ITS SAFE ASSEMBLY AND PERIODIC MAINTENANCE AND CLEANING.

DO NOT USE ANY TOOLS OTHER THAN THOSE SHOWN.

ANY SPANNERS OR ALLEN KEYS REQUIRED ARE INCLUDED WITH THE FITTINGS KIT.

DO NOT FOR ANY REASON USE A POWER TOOL TO ASSEMBLE THIS PRODUCT. ITS USE WILL INVALIDATE ANY CLAIM YOU MAY HAVE AND COULD MAKE THIS PRODUCT UNSAFE.

DEPENDING ON THE AMOUNT OF USE THIS PRODUCT RECEIVES IT MAY BE NECESSARY TO TIGHTEN UP THE FIXINGS FROM TIME TO TIME. THIS IS COMPLETELY NORMAL FOR ANY FLAT PACK FURNITURE.



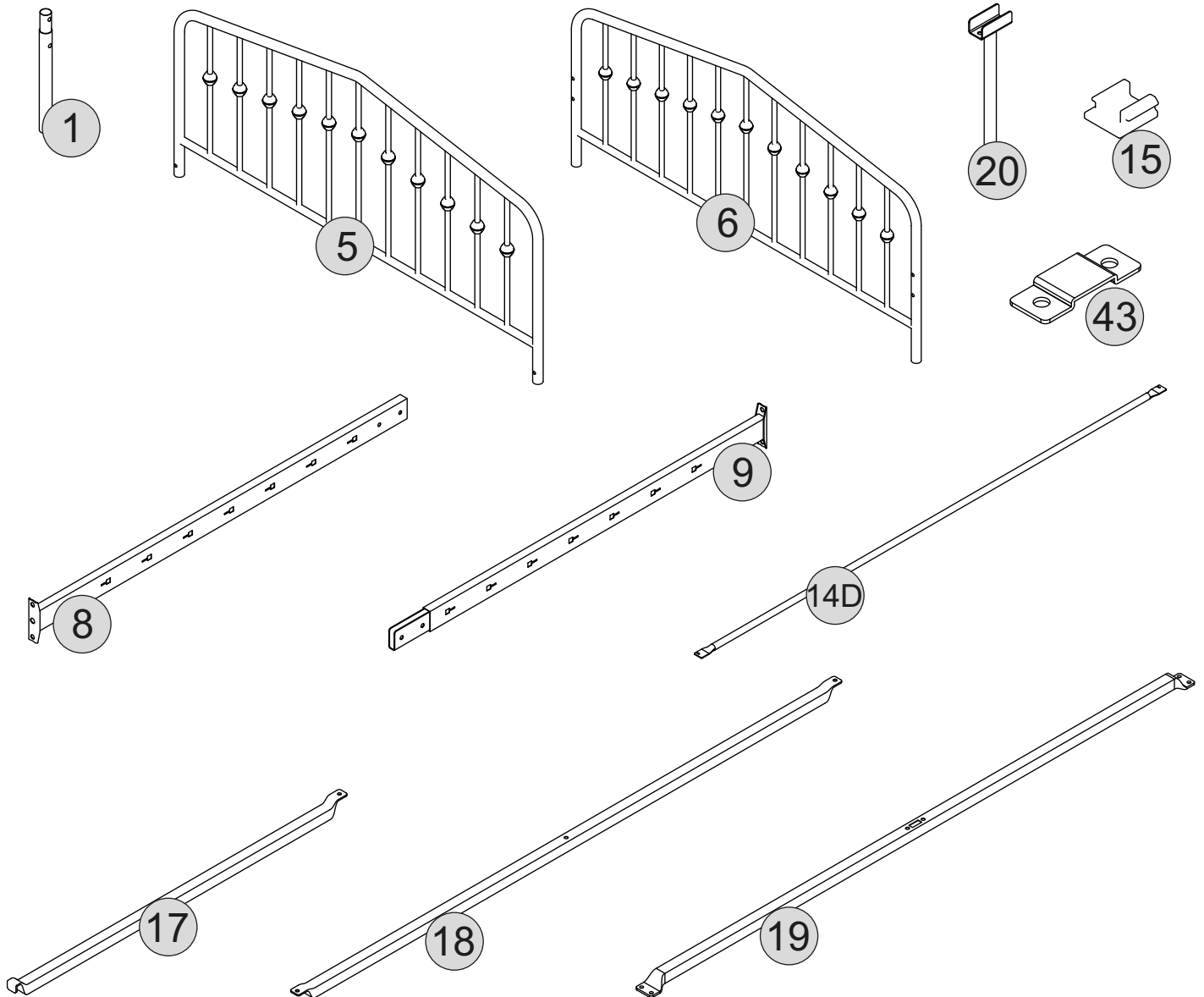



FOR CLEANING YOU MAY USE A DAMP CLOTH (NOT WET) DRY DUSTER AND NORMAL FURNITURE POLISH.

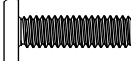
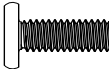

## PART LIST

Part Number	Part Code	Part Description	Quantity	Carton
1	S200-204-047-XK1-01	Headboard Post	2	1/1
5	S200-204-047-XK1-05	Headboard	1	1/1
6	S200-204-047-XK1-06	Footboard	1	1/1
8	S200-204-047-XK1-08	Siderail A	2	1/1
9	S200-204-047-XK1-09	Siderail B	2	1/1
14D	S200-204-047-XK1-14D	Slats	14	1/1
15	S200-204-047-XK1-15	Plastic Plug	28	1/1
17	S200-204-047-XK1-17	Brace	2	1/1
18	S200-204-047-XK1-18	Top/Bottom Brace	2	1/1
19	S200-204-047-XK1-19	Centre Brace	1	1/1
20	S200-204-047-XK1-20	Leg	3	1/1
43	S200-204-047-XK1-43	Bracket	1	1/1

## HARDWARE LIST

No	Part Name		Qty	Carton
A	38mm M6 Bolt		x4	1
B	22mm M6 Bolt		x12	1
C	18mm M6 Bolt		x6	1
D	22mm M8 Bolt		x8	1
E	M6 Nut		x4	1
F	M8 Spring Washer		x8	1
G	M8 Metal Washer		x8	1
H	4mm Allen Key		x1	1
I	Spanner		x1	1

THE USE OF POWER TOOLS TO ASSEMBLE THIS PRODUCT WILL INVALIDATE ANY CLAIM AND MAY DAMAGE THIS PRODUCT MAKING IT UNSAFE

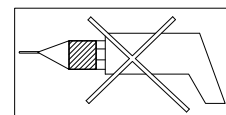

# STEP 1

## PARTS REQUIRED

1 - HEADBOARD POST x2

5 - HEADBOARD x1

## HARDWARE REQUIRED

C  02

## TOOLS REQUIRED

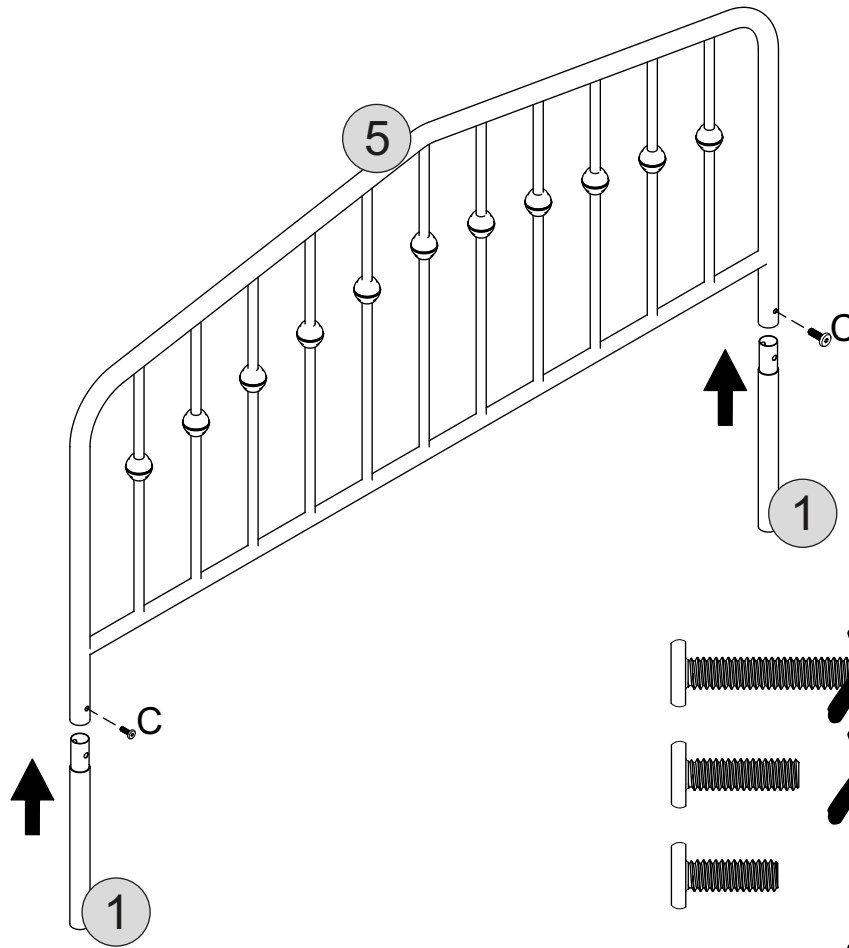

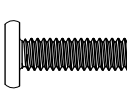
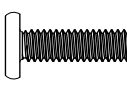
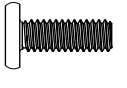
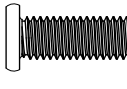
-  ~~X~~ M6x38mm
-  ~~X~~ M6x22mm
-  M6x18mm
-  ~~X~~ M8x22mm

# STEP 2

## PARTS REQUIRED

8 - SIDERAIL x2

9 - SIDERAIL x2

## HARDWARE REQUIRED

C  04

## TOOLS REQUIRED

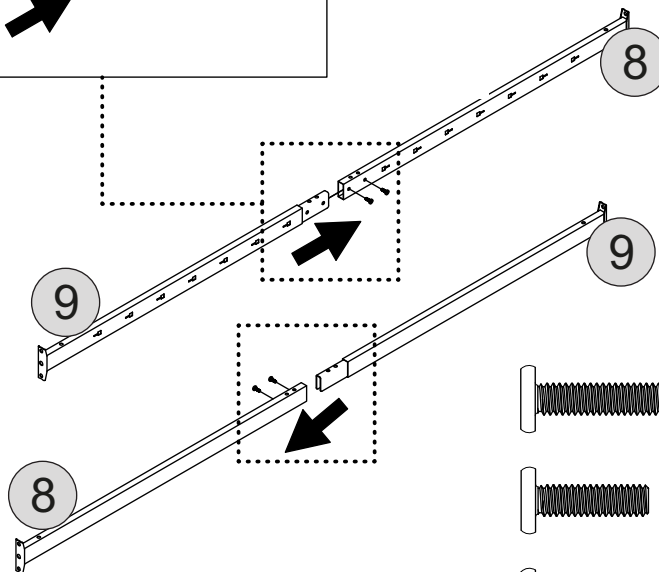
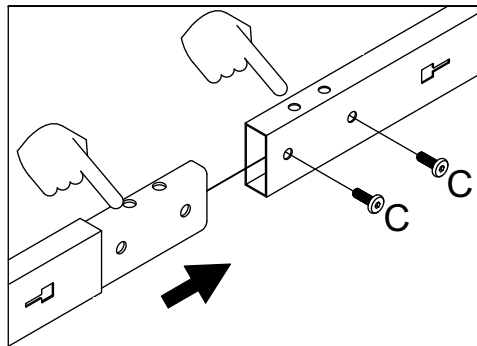

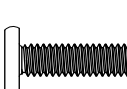
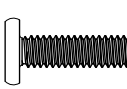
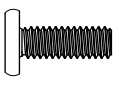
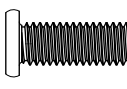
-  ~~X~~ M6x38mm
-  ~~X~~ M6x22mm
-  M6x18mm
-  ~~X~~ M8x22mm

# STEP 3

## PARTS REQUIRED

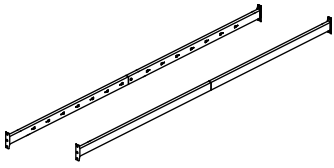

18 - TOP/BOTTOM BRACE x2



19 - CENTRE BRACE x1

## HARDWARE REQUIRED

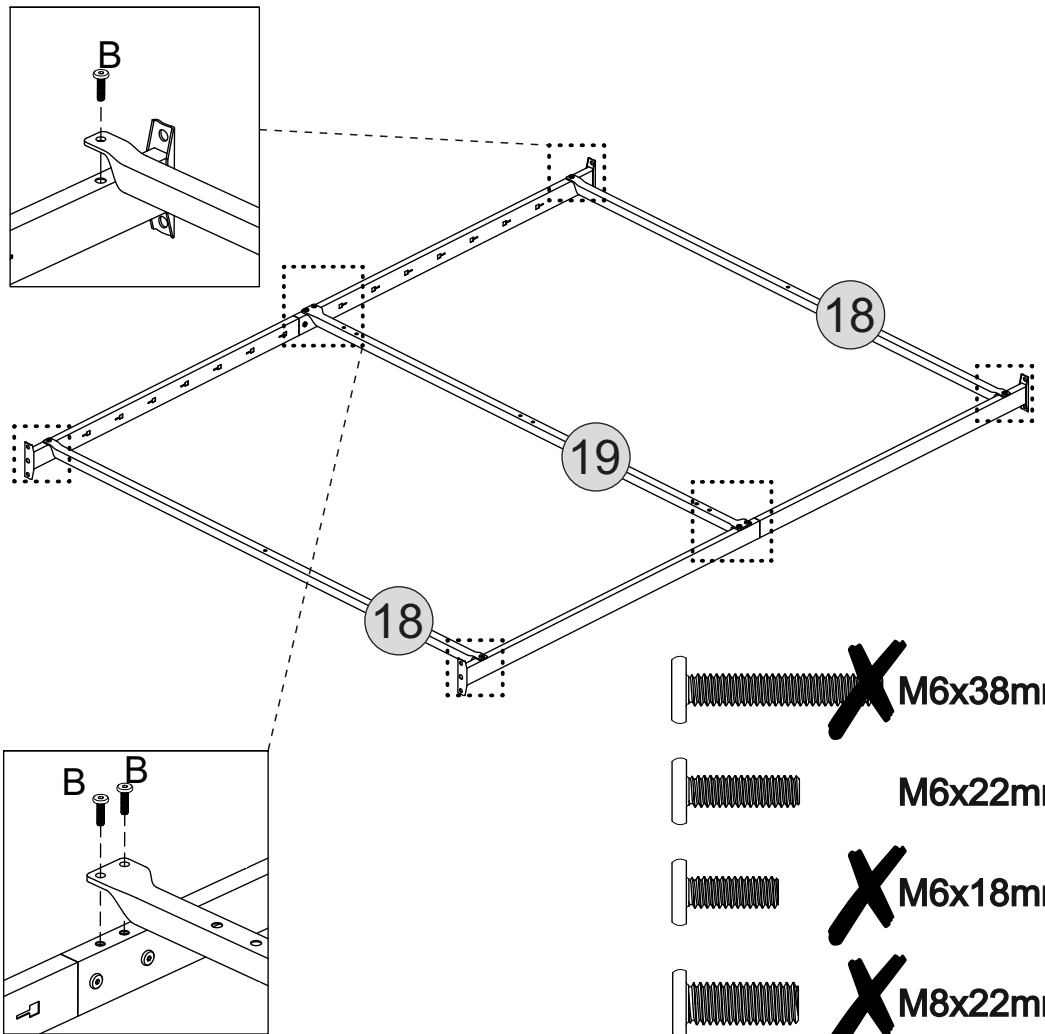

## TOOLS REQUIRED

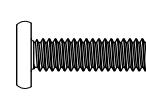

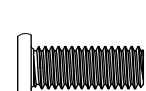
-  ~~X~~ M6x38mm
-  M6x22mm
-  ~~X~~ M6x18mm
-  ~~X~~ M8x22mm

# STEP 4

## PARTS REQUIRED

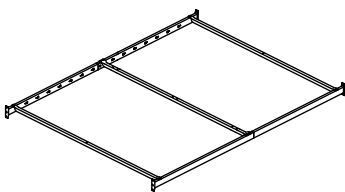

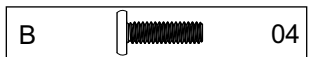

20 - LEG x2

## HARDWARE REQUIRED

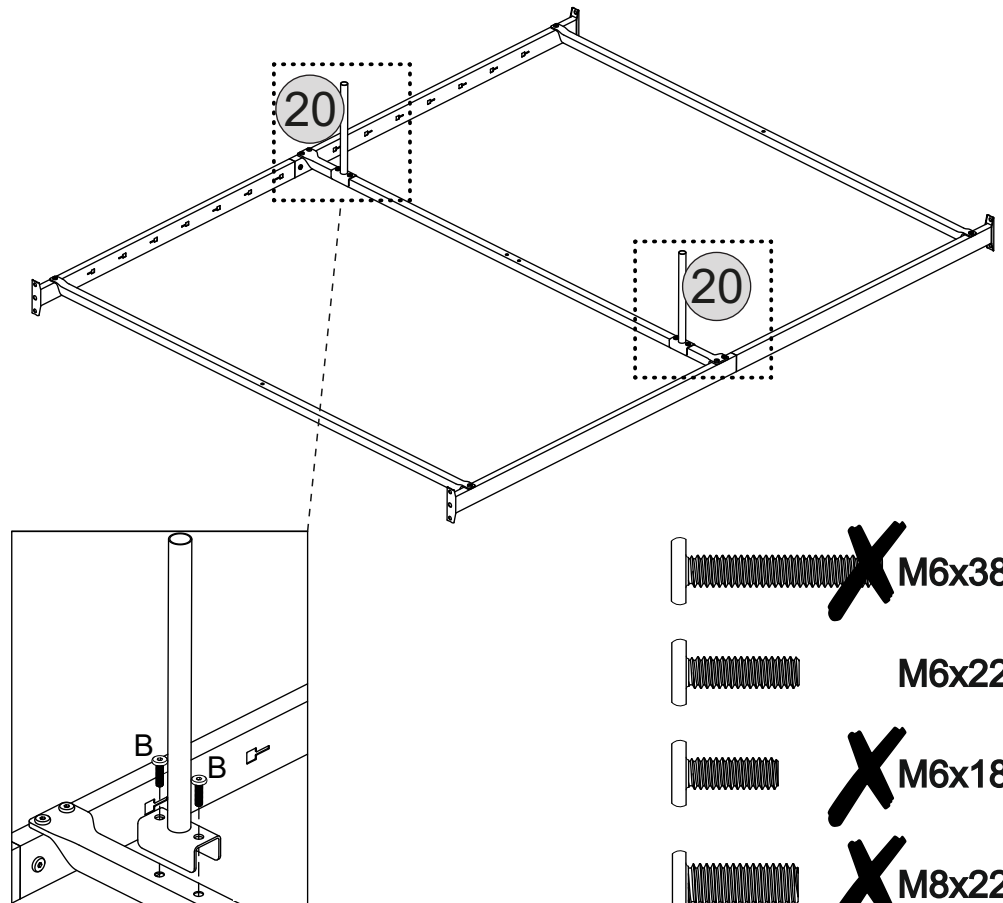

## TOOLS REQUIRED

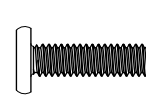

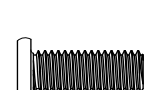
-  ~~X~~ M6x38mm
-  M6x22mm
-  ~~X~~ M6x18mm
-  ~~X~~ M8x22mm

# STEP 5

## PARTS REQUIRED

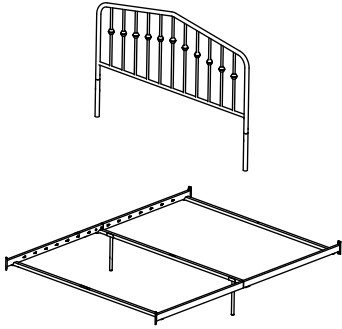

6 - FOOTBOARD x1

## HARDWARE REQUIRED

D		08
F		08
G		08

## TOOLS REQUIRED

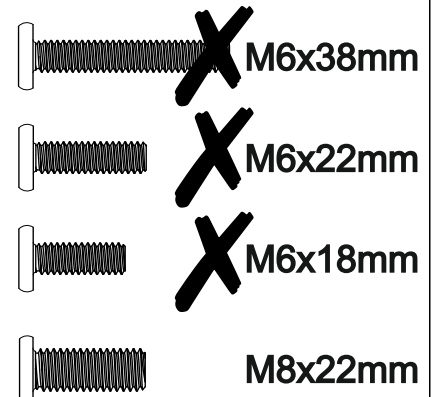
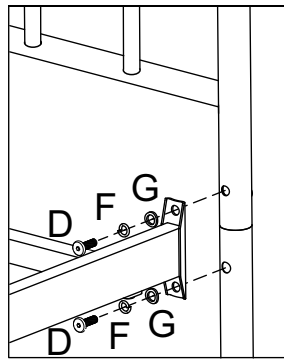
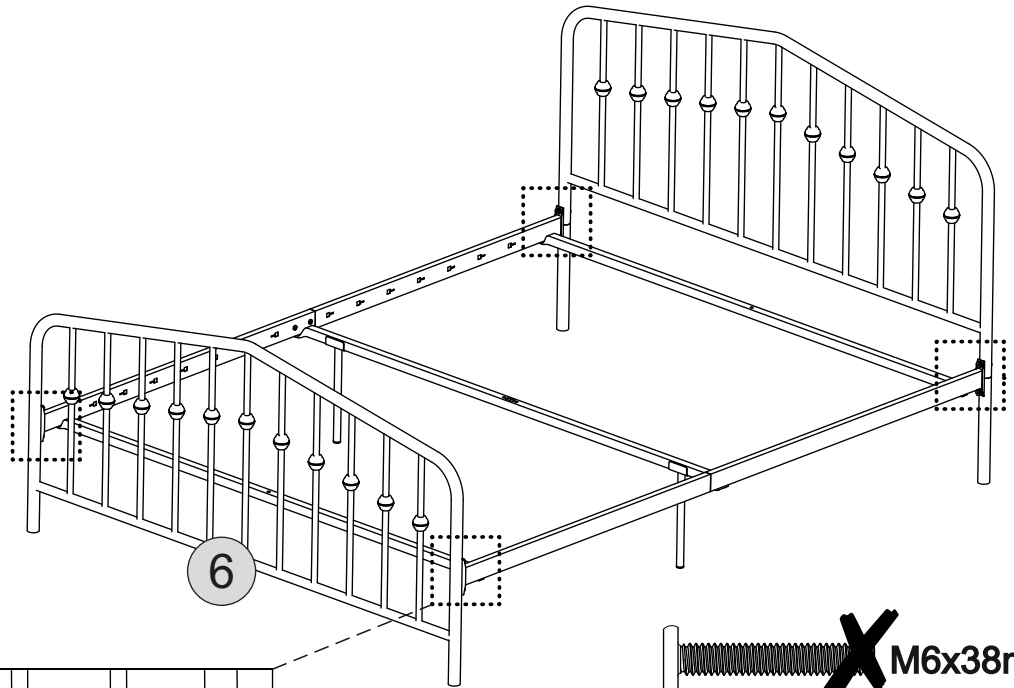

# STEP 6

## PARTS REQUIRED

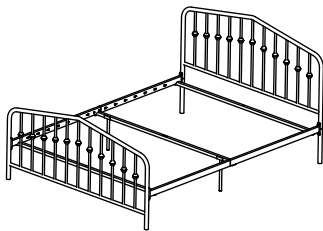

17 - BRACE x2

## HARDWARE REQUIRED

A		02
E		02

## TOOLS REQUIRED

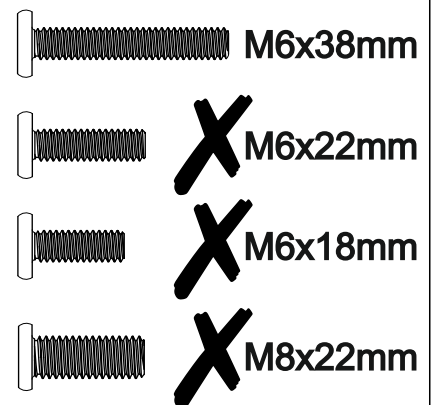
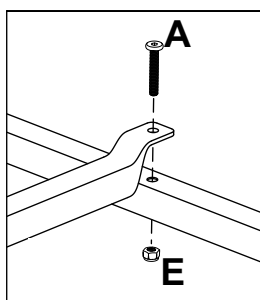
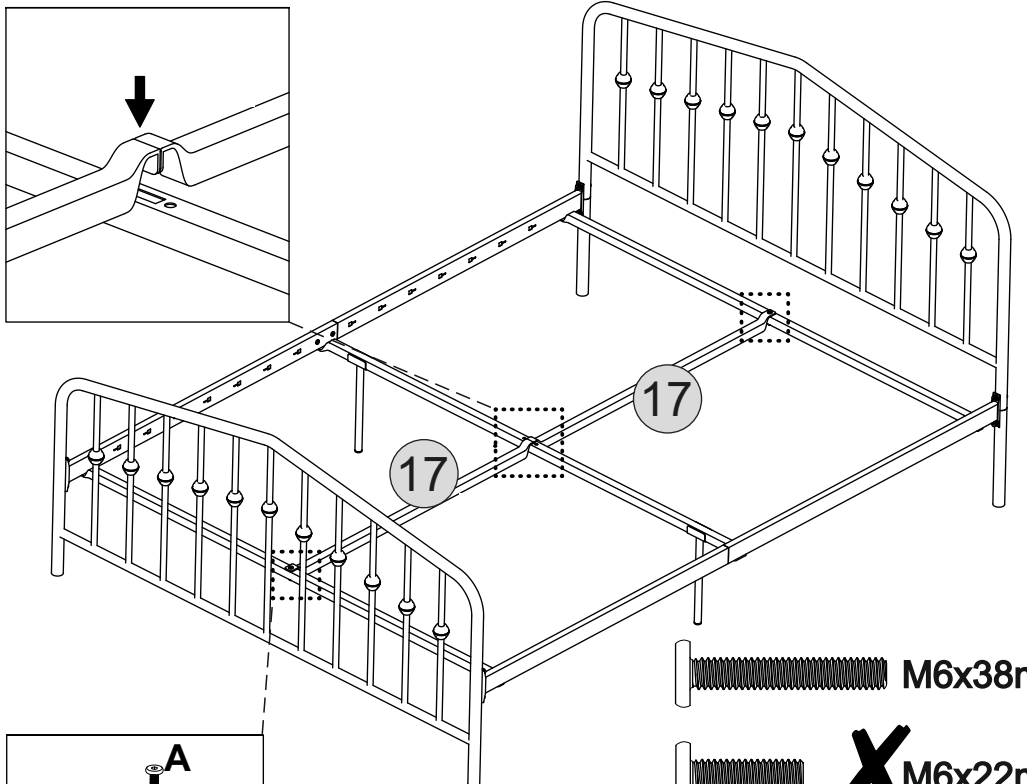
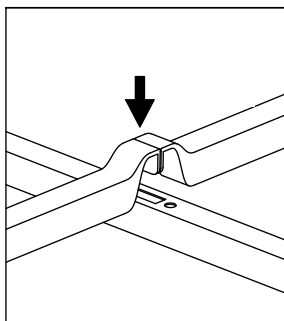
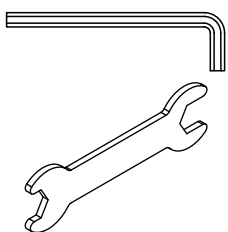

# STEP 7

## PARTS REQUIRED

20 - LEG x1

43 - BRACKET x1



## HARDWARE REQUIRED

A  02

E  02

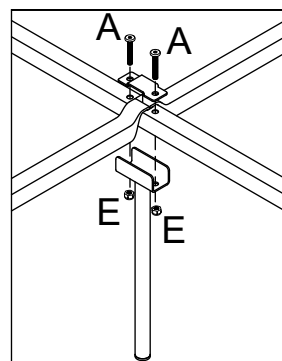
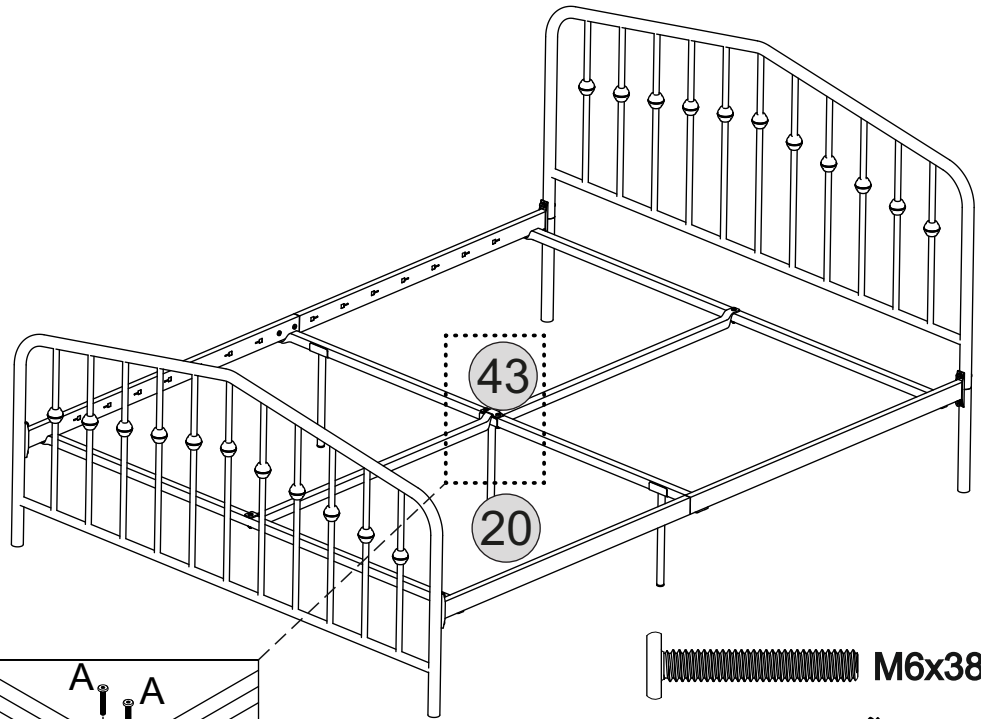
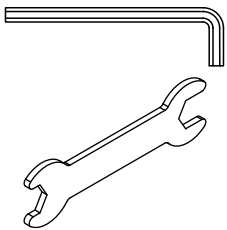
## TOOLS REQUIRED

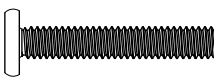
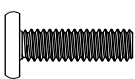
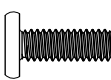

-  M6x38mm
-  ~~X~~ M6x22mm
-  ~~X~~ M6x18mm
-  ~~X~~ M8x22mm

# STEP 8

## PARTS REQUIRED

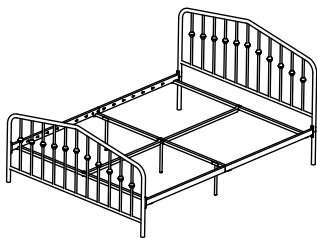

14D - SLATS x14

15 - PLASTIC PLUG x28

## HARDWARE REQUIRED

## TOOLS REQUIRED

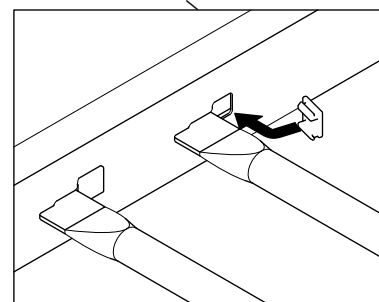
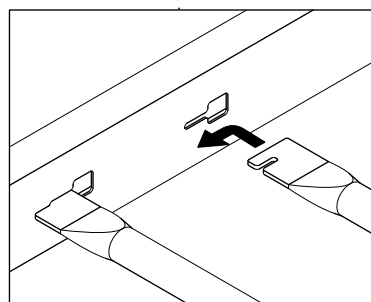
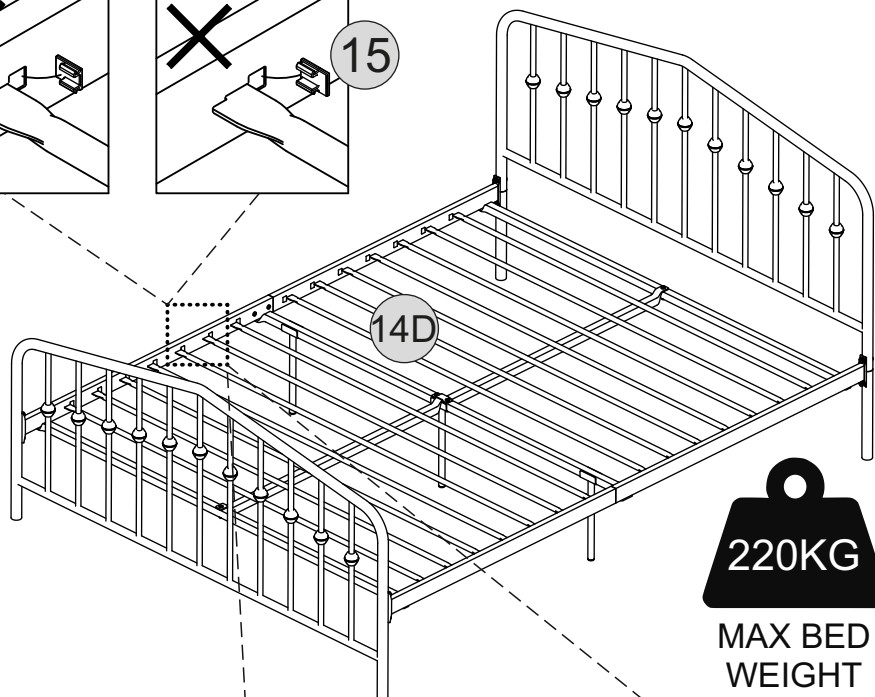
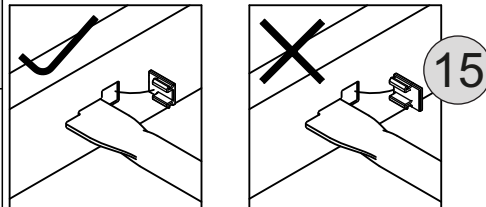

**220KG**  
MAX BED WEIGHT