

SILVER VENTURA 3' BUNK BED ASSEMBLY INSTRUCTIONS

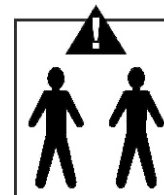
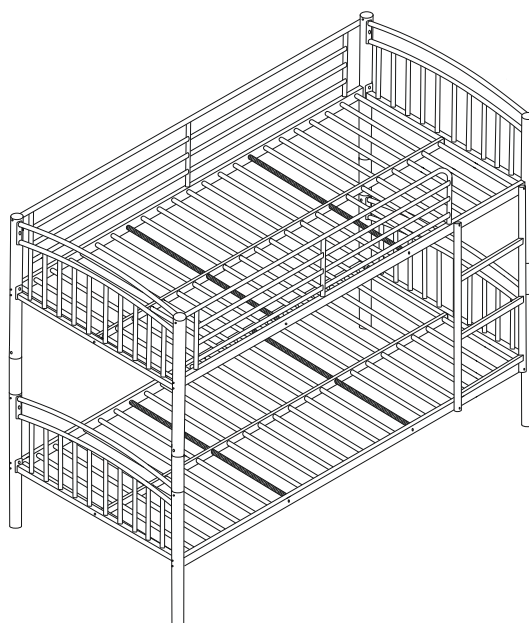

IMPORTANT FOR DOMESTIC USE ONLY

PLEASE READ AND FOLLOW THESE INSTRUCTIONS CAREFULLY

RETAIN FOR FUTURE REFERENCE

SAFETY WARNING

- All bunk beds and high beds intended to be assembled by someone other than the manufacturer or their representative shall contain assembly instructions a list of the parts supplied and details of any tools required to assemble the bed.
- We recommend that you use the mattress at size: 1900x900x160mm.
- All assembly fastenings should always be tightened properly and that care should be taken that no fittings are loose.
- Instructions regarding positioning and connection of the means of access.
- The ladder is not for playing on, only use to climb onto the top bunk.
- We recommend only one person on the upper bunk at one time.
- Warning:-** The bunk bed or high bed should not be used if any structural part is broken or missing.
- The top of the mattress shall be at least 160mm below the upper edge of the safety barriers.
- Warning:-** Children can become trapped between the bed and the wall to avoid risk of serious injury the distance between the top safety barrier and the wall shall not exceed 75mm or shall be more than 230mm.
- Warning:** Bunk beds and high beds can present a serious risk of injury from strangulation if not used correctly. Never attach or hang items to any part of the bunk bed that are not designed to be used with the bed, for example, but not limited to ropes, strings, cords, hooks, belts and bags.
- The ventilation of the room is necessary in order to keep the humidity low and to prevent mold in and around the bed.
- The manufacturer's instruction must be always followed.
- EN 747-1&2:2012+A1:2015 TEST version.

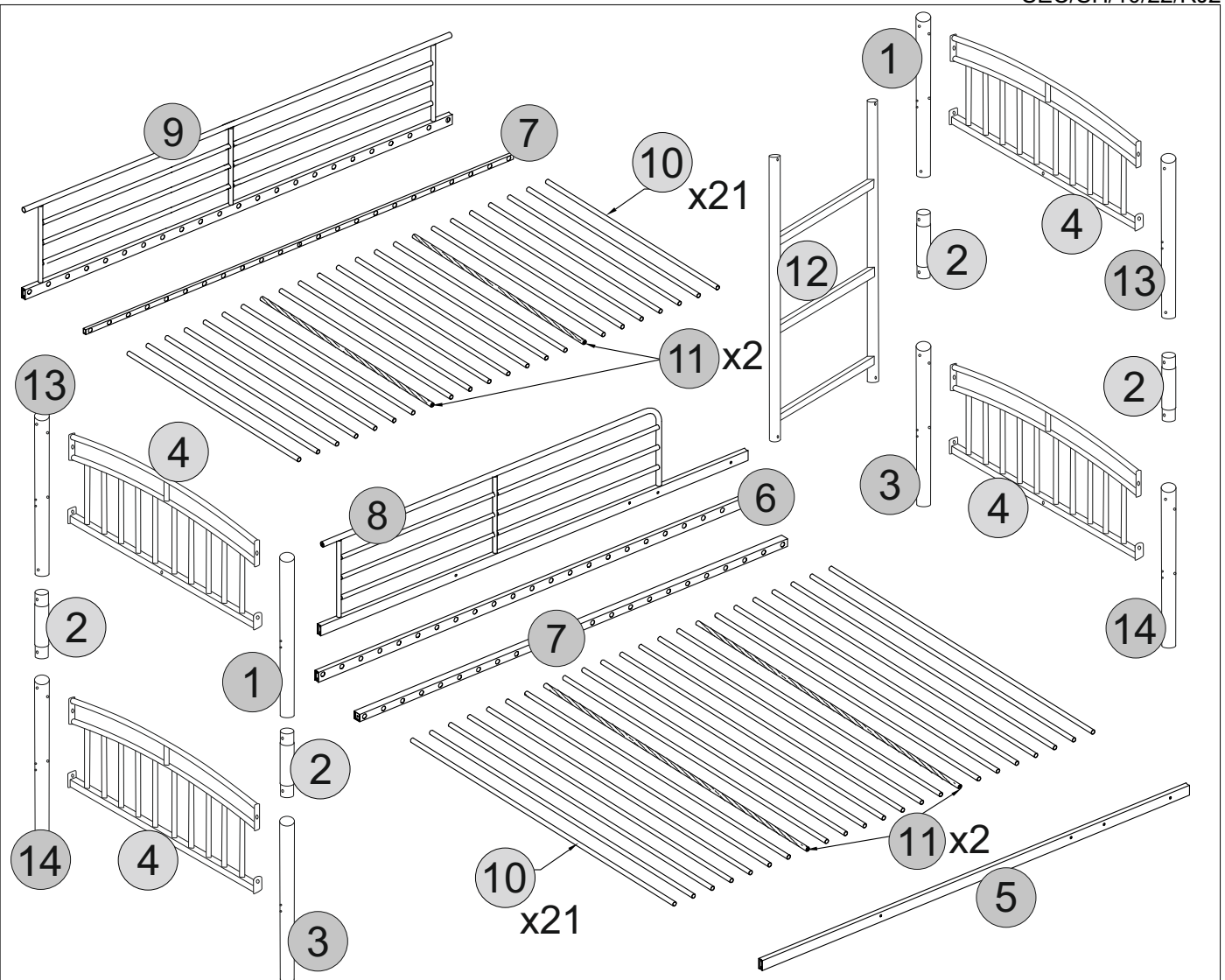











PLEASE CHECK THAT YOU HAVE ALL THE PARTS LISTED BEFORE YOU START ASSEMBLING. IF YOU DO FIND THAT SOMETHING IS MISSING, DO NOT CONTINUE ASSEMBLY. PLEASE CONTACT YOUR SUPPLIER IMMEDIATELY.

PARTS LIST

Part Number	Part Code	Part Description	Quantity	Carton
1	S200-205-017-RJ2-01	Upper Bed Post 1	2	1
2	S200-205-017-RJ2-02	Neutral Post	4	1
3	S200-205-017-RJ2-03	Lower Bed Post	2	1
4	S200-205-017-RJ2-04	Headboard/Footboard	4	1
5	S200-205-017-RJ2-05	Lower Front Bed Rail	1	1
6	S200-205-017-RJ2-06	Lower Back Bed Rail	1	1
7	S200-205-017-RJ2-07	Middle Bed Rail	2	1
8	S200-205-017-RJ2-08	Upper Front Guardrail	1	1
9	S200-205-017-RJ2-09	Upper Back Guardrail	1	1
10	S200-205-017-RJ2-10	Slats	42	1
11	S200-205-017-RJ2-11	Fixed Slats	4	1
12	S200-205-017-RJ2-12	Ladder	1	1
13	S200-205-017-RJ2-13	Upper Bed Post 2	2	1
14	S200-205-017-RJ2-14	Lower Bed Post 2	2	1

HARDWARE LIST

REF		HARDWARE NAME	QTY
A		M6 x 70mm Bolt	19PCS
B		M6 x 55mm Bolt	4PCS
C		M6 x 40mm Bolt	4PCS
D		M6 x 16mm Bolt	8PCS
E		M6 x 12mm Bolt	24PCS
F		M6 Nut	4PCS
G		18 x 6.5mm Washer	19PC
H		Plastic Post Insert	8PCS
I		M10 Spanner	1PC
J		Allen Key M4	1PC
K		Plastic Cap	2PC

PLEASE CHECK THAT YOU HAVE ALL THE PARTS LISTED BEFORE YOU START ASSEMBLING. IF YOU DO FIND THAT SOMETHING IS MISSING, DO NOT CONTINUE ASSEMBLY. PLEASE CONTACT YOUR SUPPLIER IMMEDIATELY.

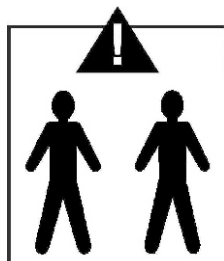

TWO PEOPLE ARE NEEDED TO ASSEMBLE THIS BUNK BED.

STEP 1

PARTS REQUIRED

- 3 - LOWER BED POST x1
- 4 - HEADBOARD/FOOTBOARD x1
- 14 - LOWER BED POST 2 x1

HARDWARE REQUIRED



TOOLS REQUIRED

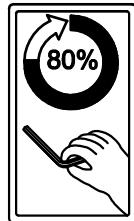
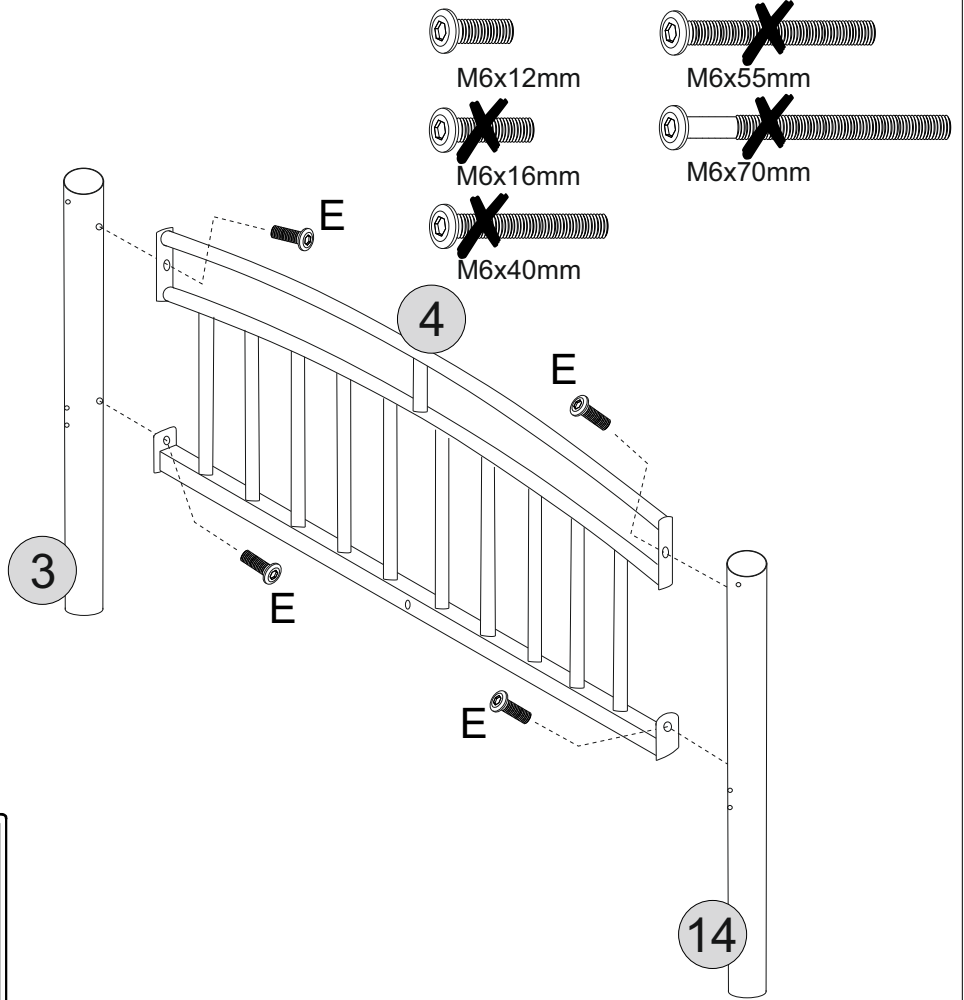
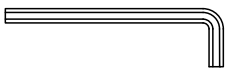

DO NOT FULLY TIGHTEN THE BOLTS AT THIS STAGE !!

STEP 2

PARTS REQUIRED

- 3 - LOWER BED POST x1
- 4 - HEADBOARD/FOOTBOARD x1
- 14 - LOWER BED POST 2 x1

HARDWARE REQUIRED

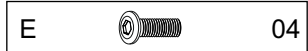

TOOLS REQUIRED

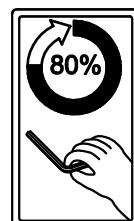
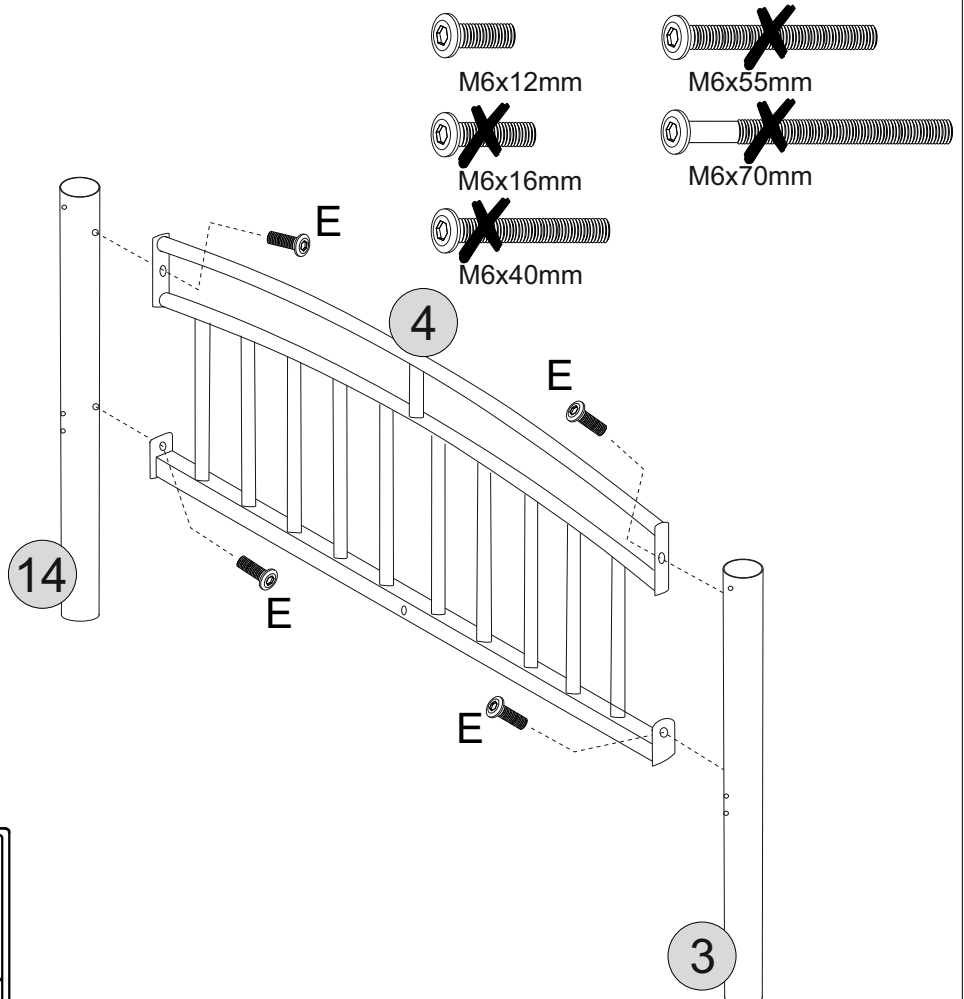

DO NOT FULLY TIGHTEN THE BOLTS AT THIS STAGE !!

STEP 3

PARTS REQUIRED

6 - LOWER BACK BED RAIL x1

7 - MIDDLE BED RAIL x1

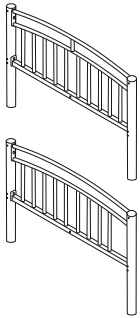

HARDWARE REQUIRED

A  04

C  02

G  04

TOOLS REQUIRED

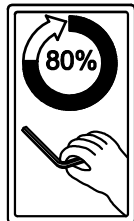
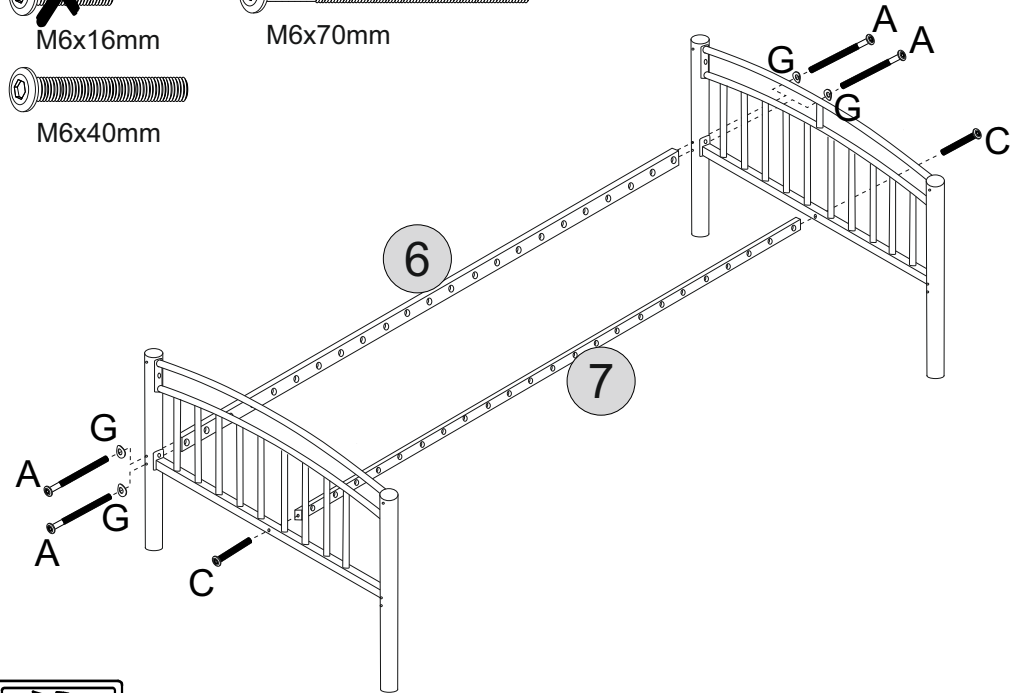
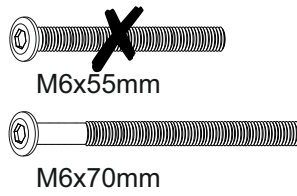
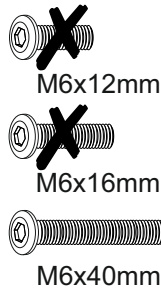

DO NOT FULLY TIGHTEN THE BOLTS AT THIS STAGE !!

STEP 4

PARTS REQUIRED

10 - SLATS x21

11 - FIXED SLATS x2

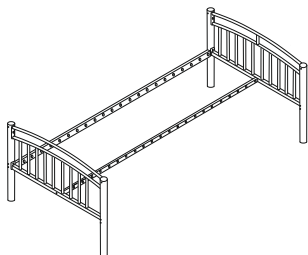

HARDWARE REQUIRED

D  02

TOOLS REQUIRED

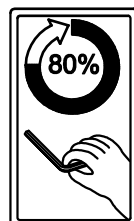
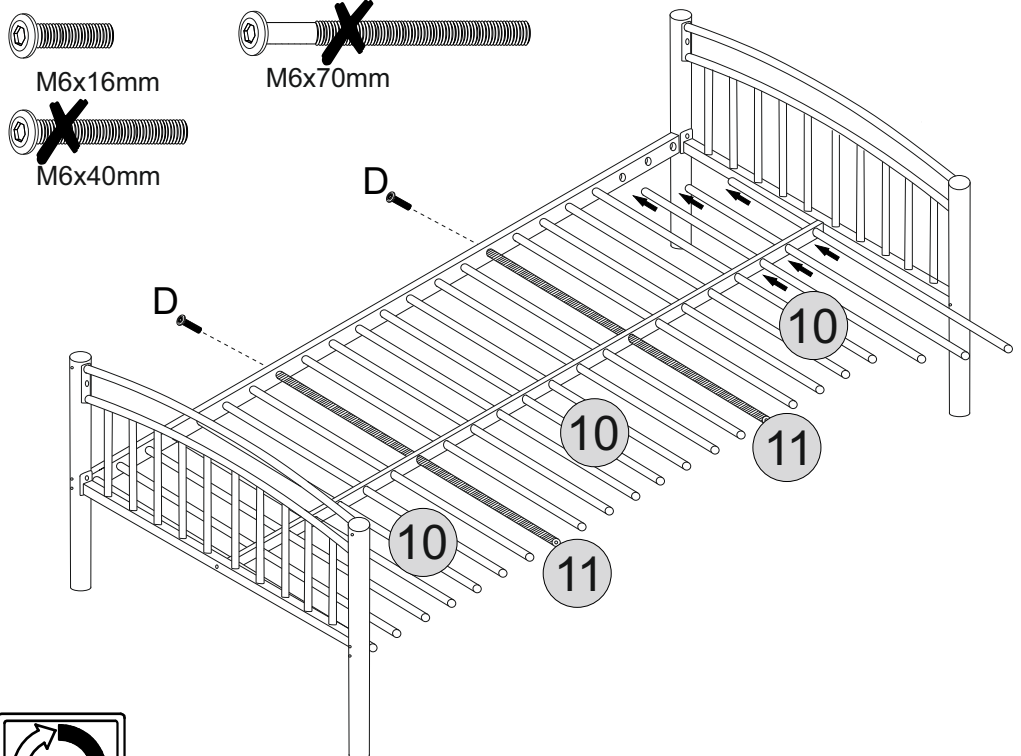
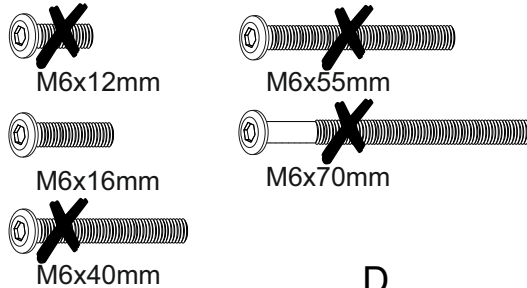
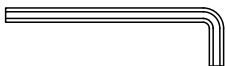

DO NOT FULLY TIGHTEN THE BOLTS AT THIS STAGE !!

STEP 5

PARTS REQUIRED

5 - LOWER FRONT BED RAIL x1

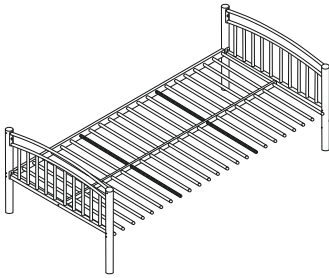

HARDWARE REQUIRED

A  04

D  02

G  04

TOOLS REQUIRED

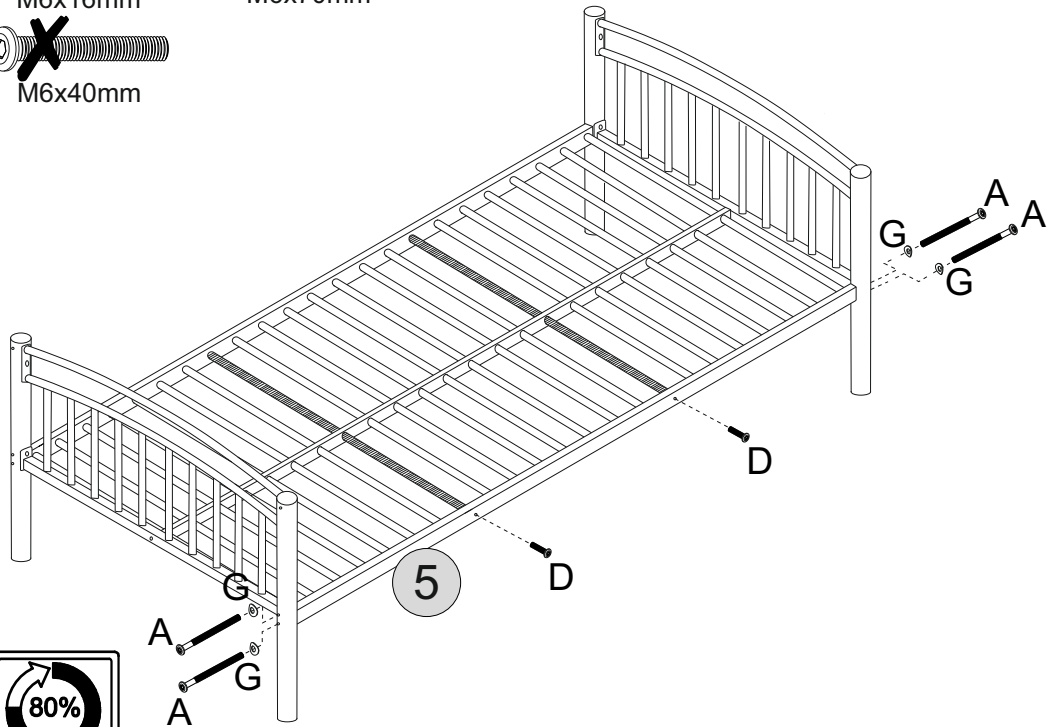
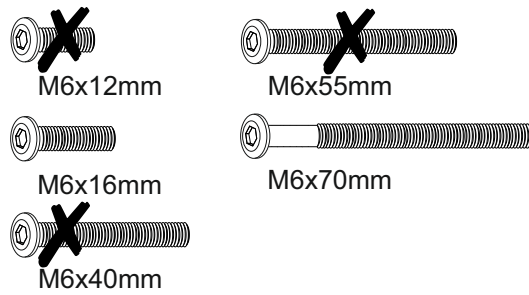

DO NOT FULLY TIGHTEN THE BOLTS AT THIS STAGE !!

STEP 6

PARTS REQUIRED

1 - UPPER BED POST 1 x1

4 - HEADBOARD/FOOTBOARD x1

13 - UPPER BED POST 2 x1

HARDWARE REQUIRED

E  04

TOOLS REQUIRED

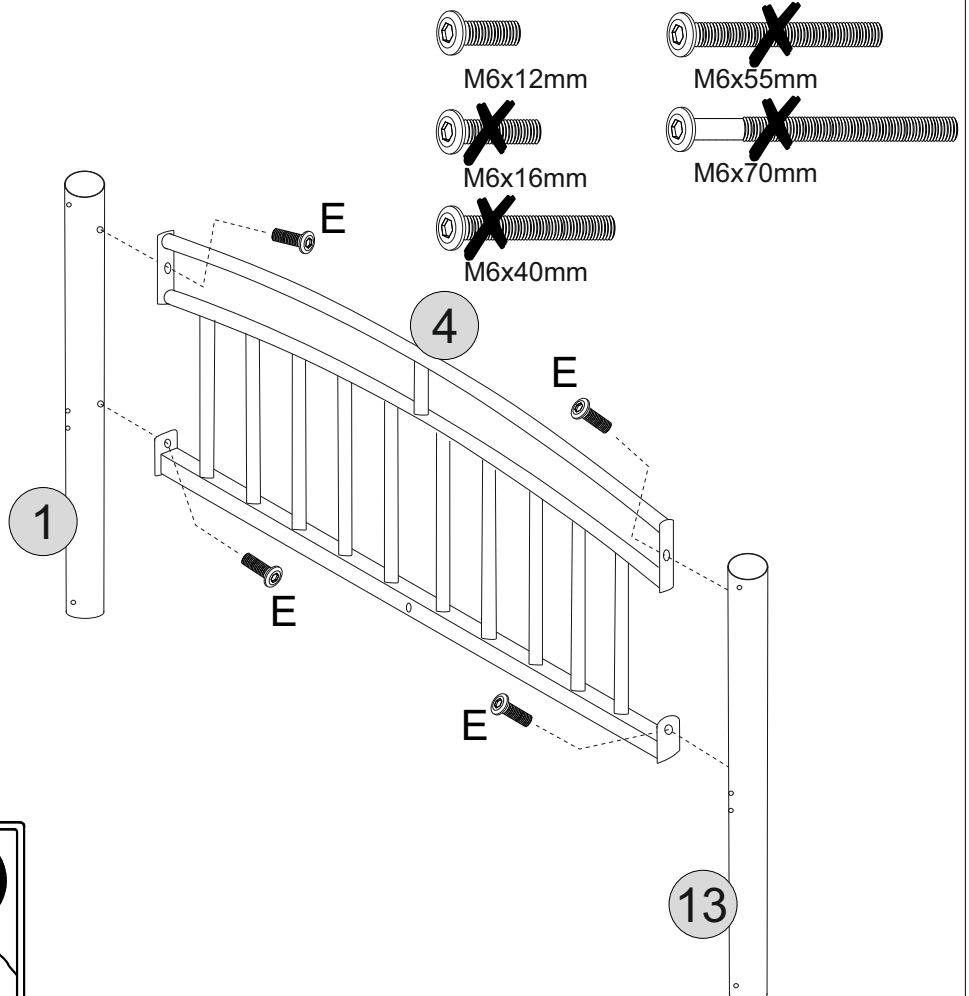
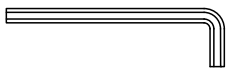

DO NOT FULLY TIGHTEN THE BOLTS AT THIS STAGE !!

STEP 7

PARTS REQUIRED

1 - UPPER BED POST 1 x1

4 - HEADBOARD/FOOTBOARDx1

13 - UPPER BED POST 2 x1

HARDWARE REQUIRED

E  04

TOOLS REQUIRED

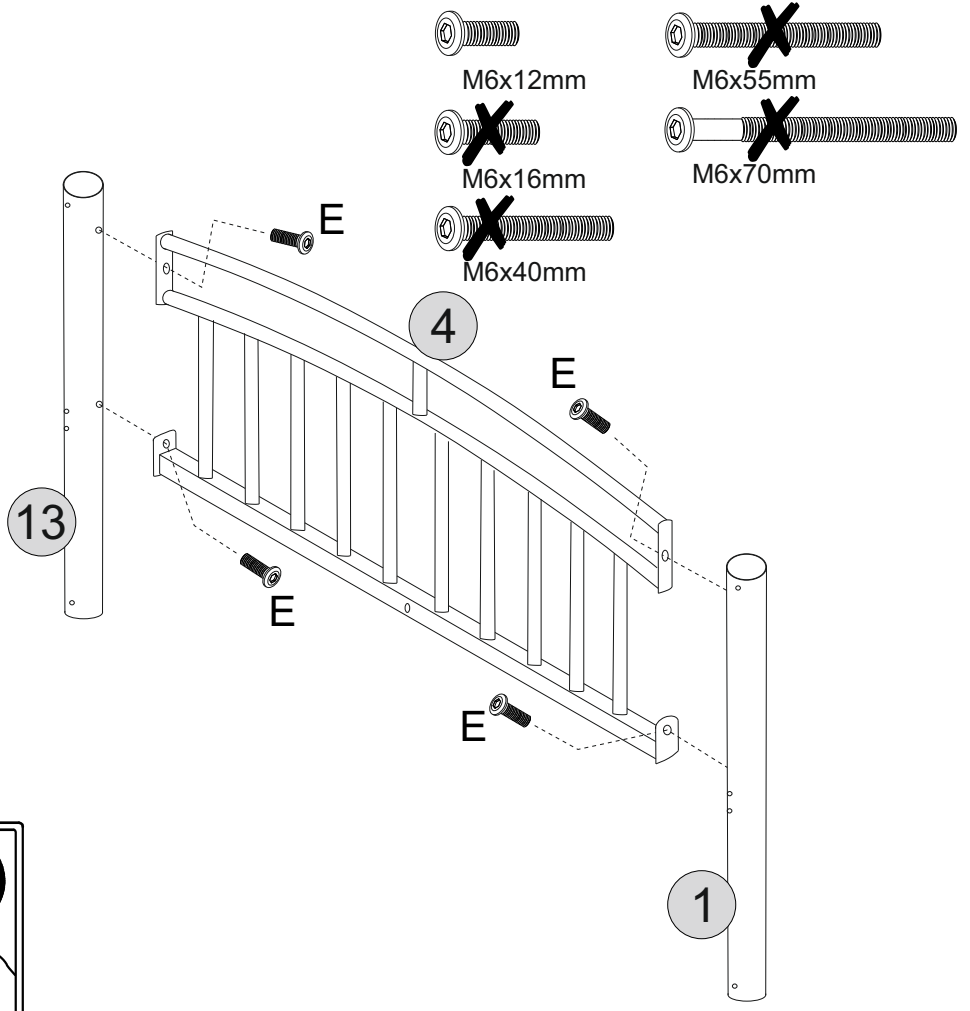

STEP 8

PARTS REQUIRED

7 - MIDDLE BED RAIL x1

9 - UPPER BACK GUARDRAILx1

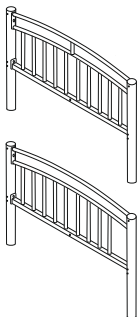

HARDWARE REQUIRED

A  06

C  02

G  06

TOOLS REQUIRED

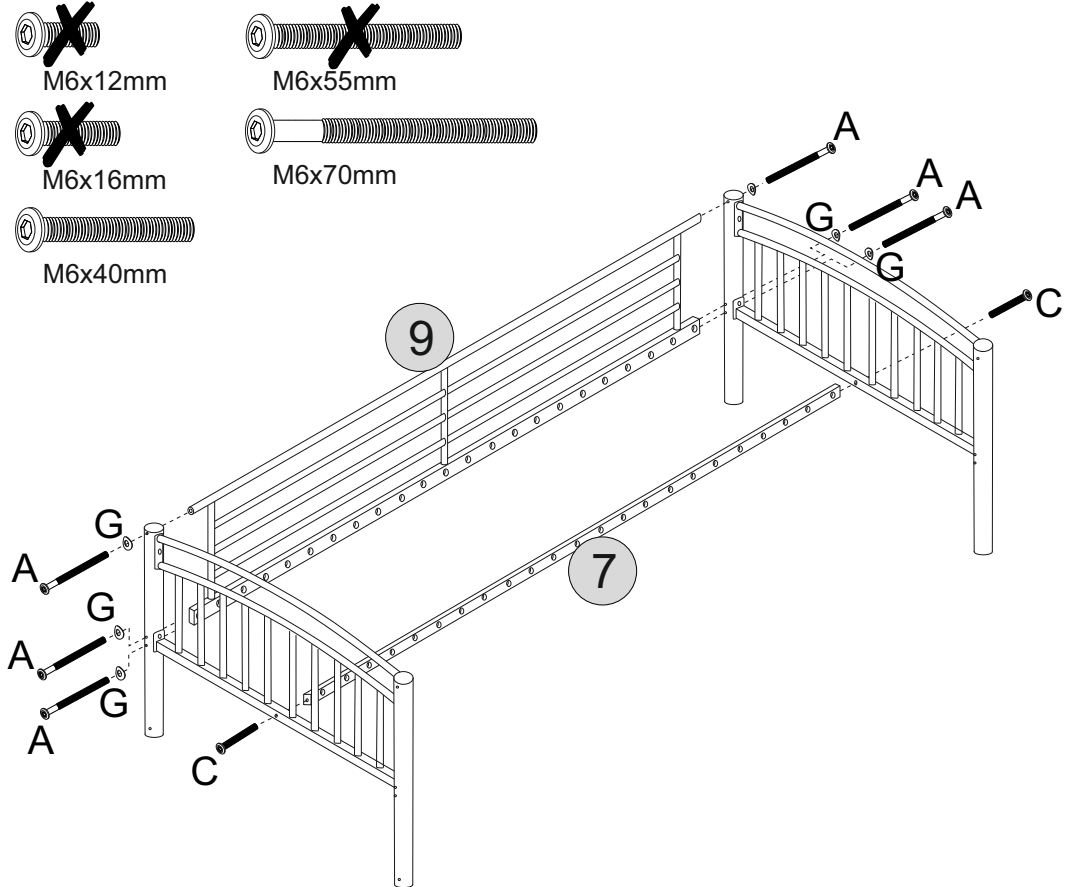

STEP 9

PARTS REQUIRED

10 - SLATS x21

11 - FIXED SLATS x2

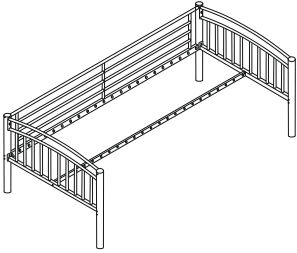

HARDWARE REQUIRED

D  02

K  02

TOOLS REQUIRED

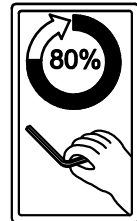
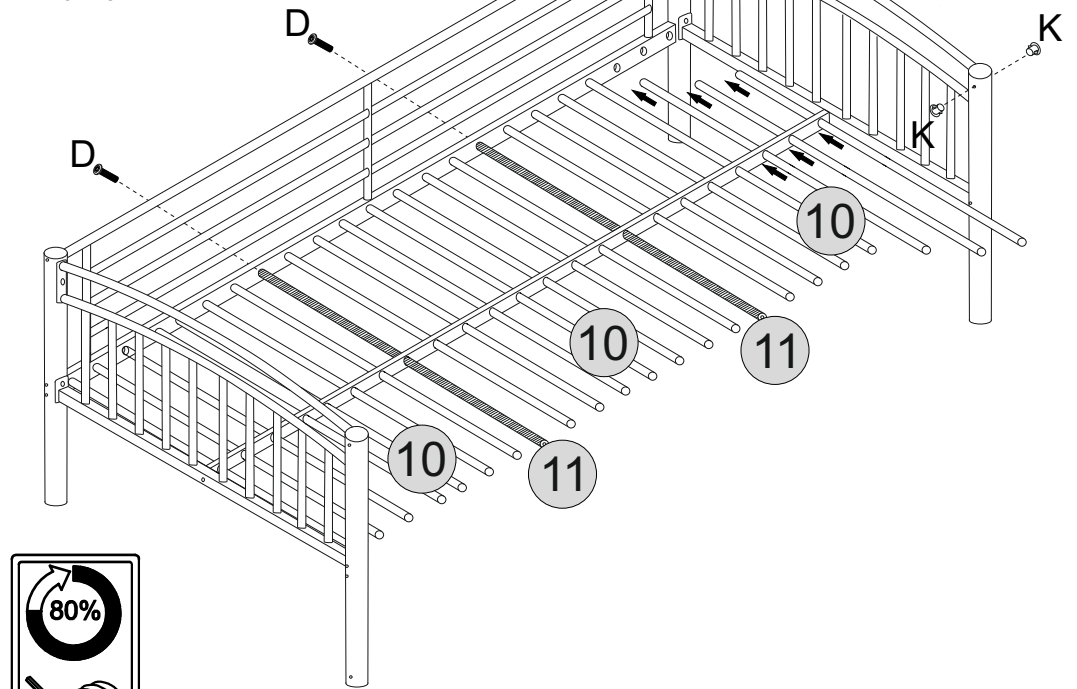
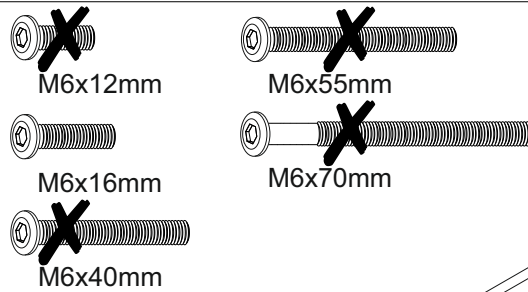

DO NOT FULLY TIGHTEN THE BOLTS AT THIS STAGE !!

STEP 10

PARTS REQUIRED

8 - UPPER FRONT GUADRAIL x21

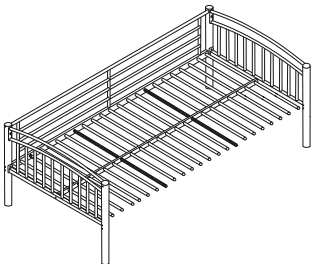

HARDWARE REQUIRED

A  05

D  02

G  05

TOOLS REQUIRED

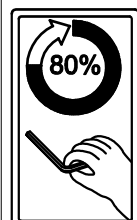
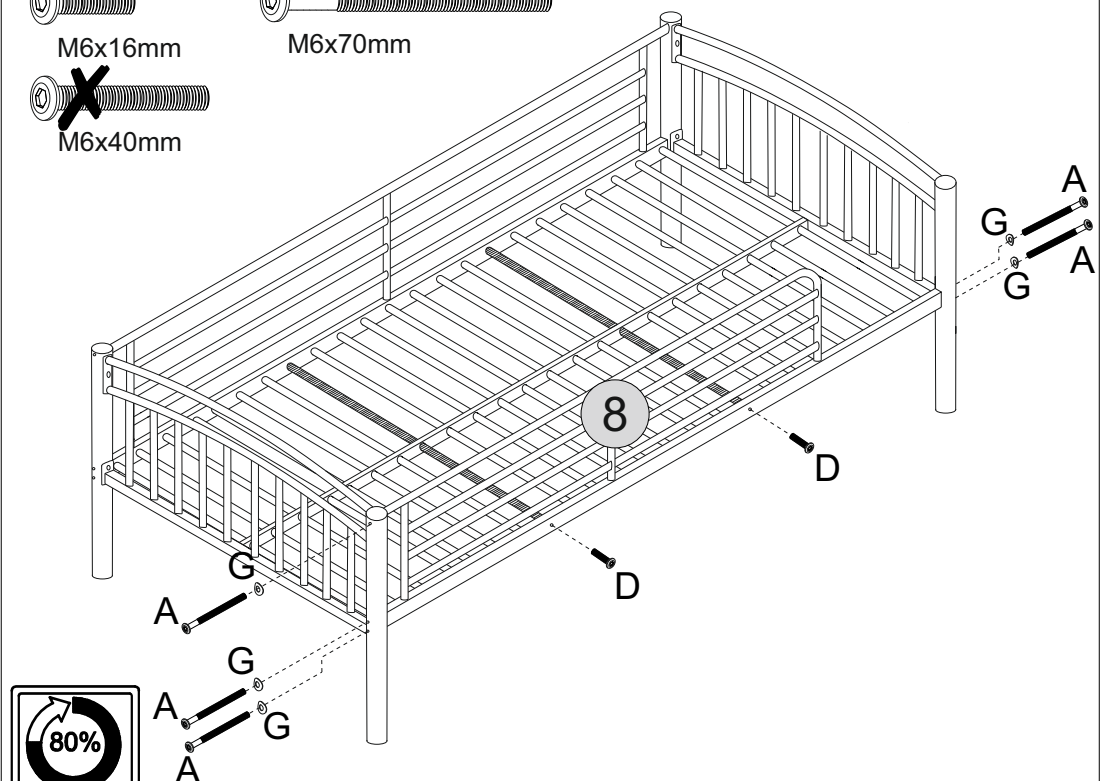
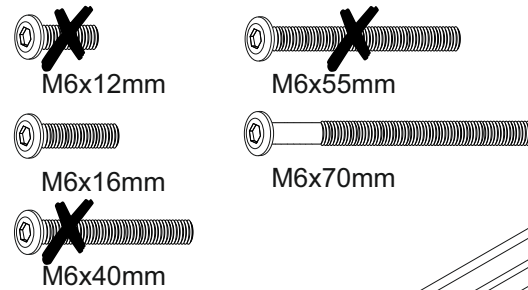

DO NOT FULLY TIGHTEN THE BOLTS AT THIS STAGE !!

STEP 11

PARTS REQUIRED

2 - NEUTRAL POST x4

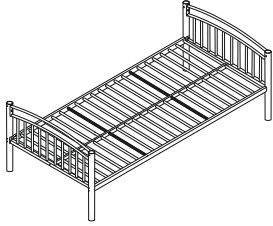

HARDWARE REQUIRED

E  04

TOOLS REQUIRED

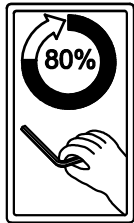
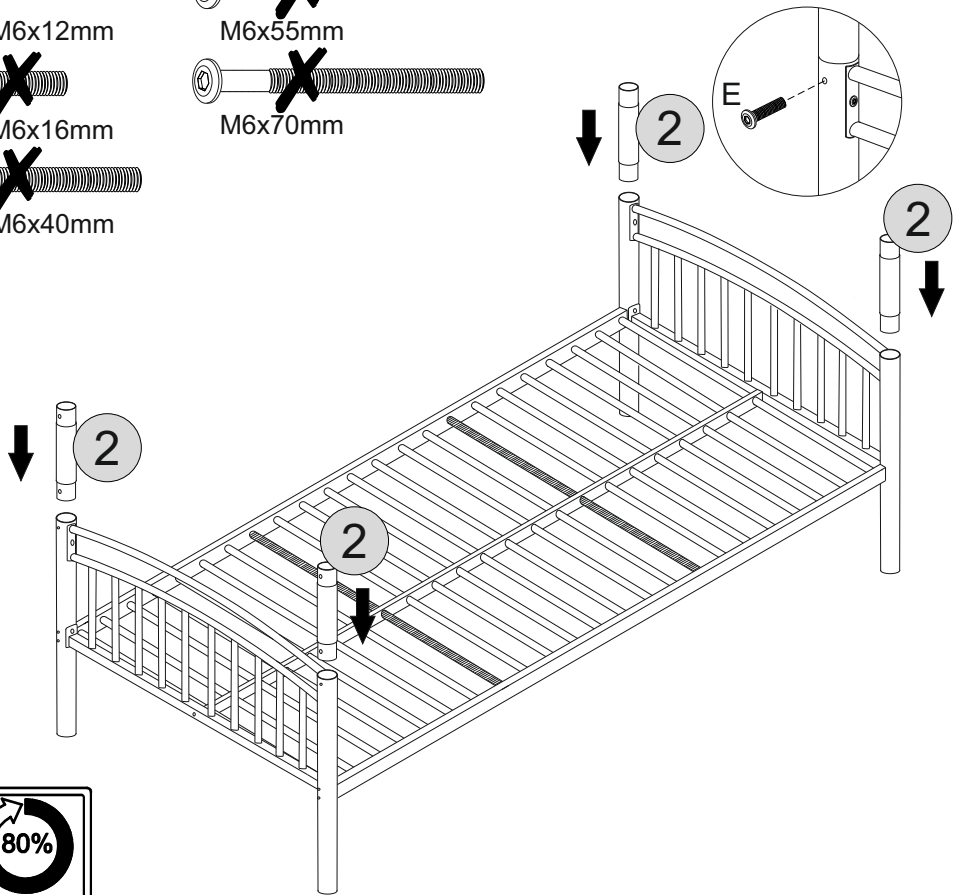
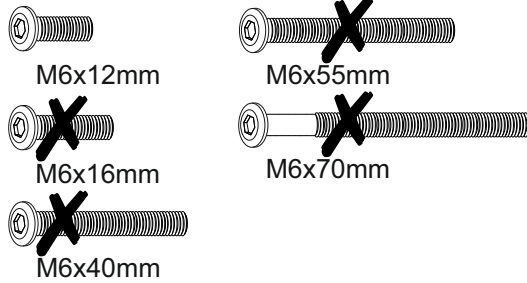

DO NOT FULLY TIGHTEN THE BOLTS AT THIS STAGE !!

STEP 12

PARTS REQUIRED

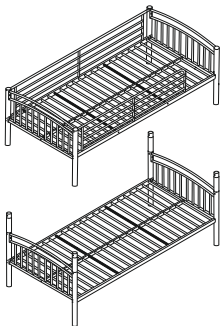

HARDWARE REQUIRED

E  04

TOOLS REQUIRED

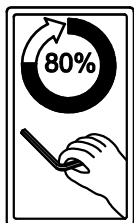
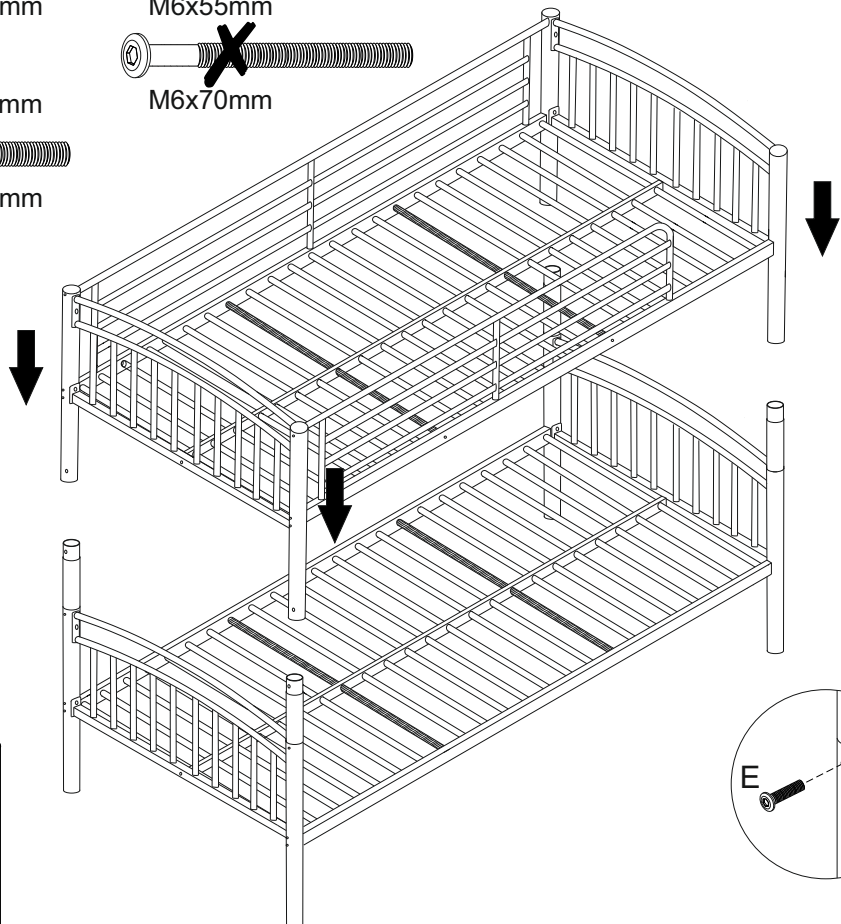
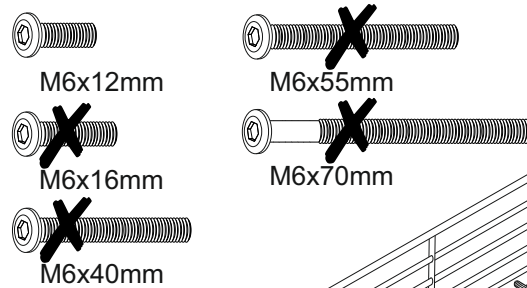
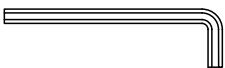

DO NOT FULLY TIGHTEN THE BOLTS AT THIS STAGE !!

STEP 13

PARTS REQUIRED

12 - LADDER x1

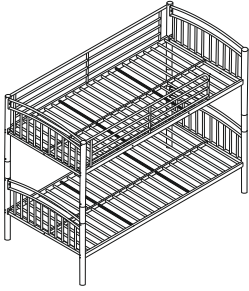

HARDWARE REQUIRED

B  04

F  04

TOOLS REQUIRED

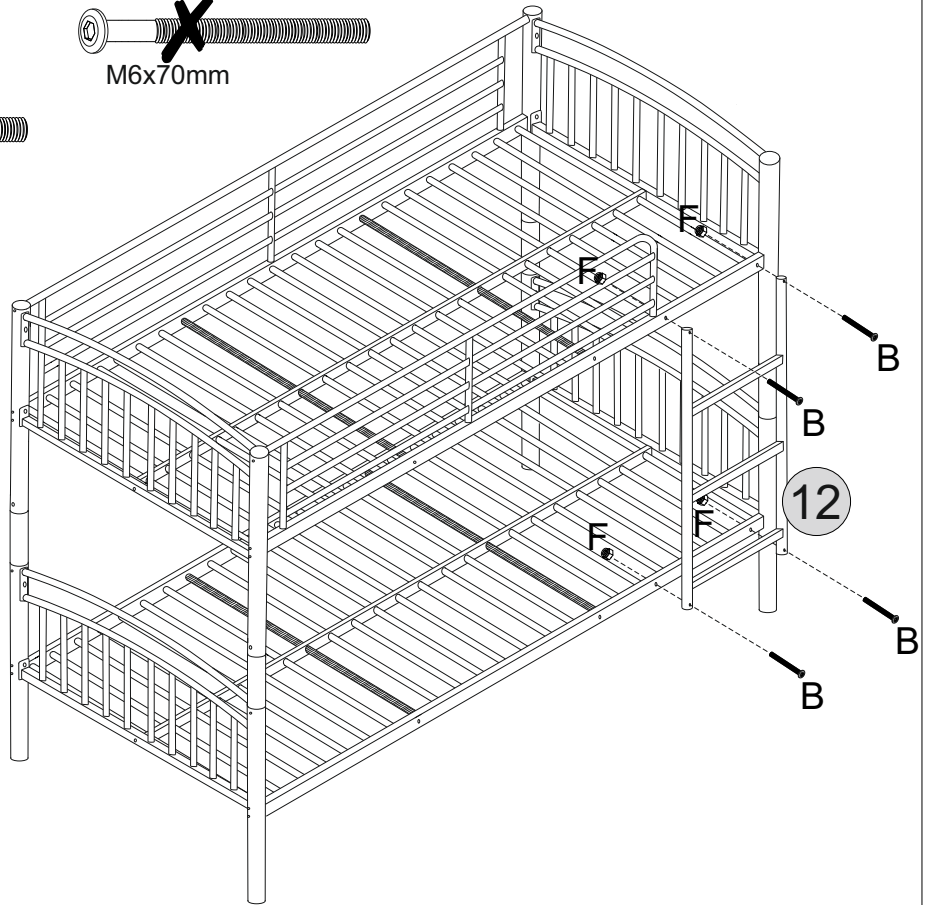
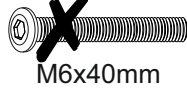
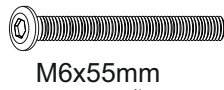
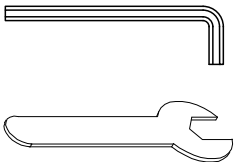

DO NOT FULLY TIGHTEN THE BOLTS AT THIS STAGE !!

STEP 14

PARTS REQUIRED

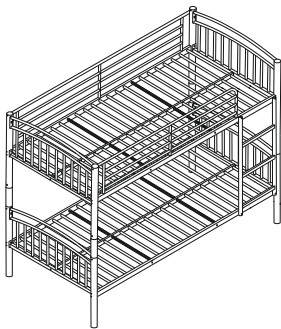

HARDWARE REQUIRED

TOOLS REQUIRED

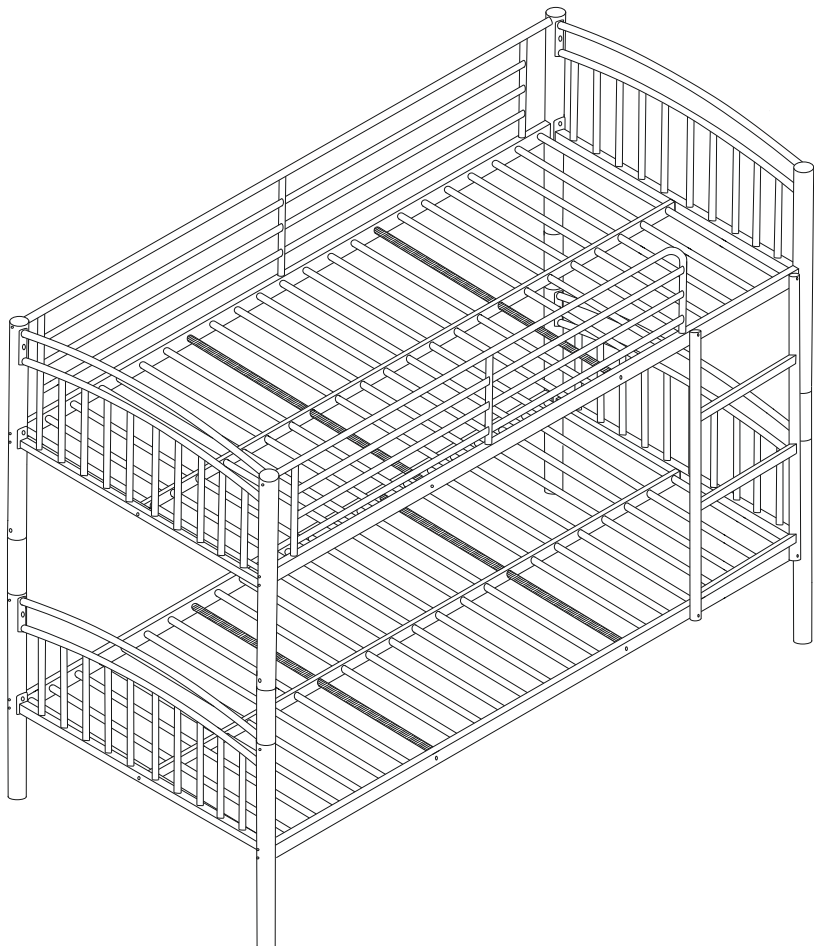

NOW FULLY TIGHTEN ALL BOLTS !!

STEP 15

PARTS REQUIRED



HARDWARE REQUIRED

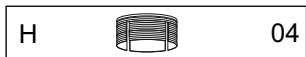

TOOLS REQUIRED

THE BUNK BED CAN BE SPLIT INTO TWO SINGLE BEDS.

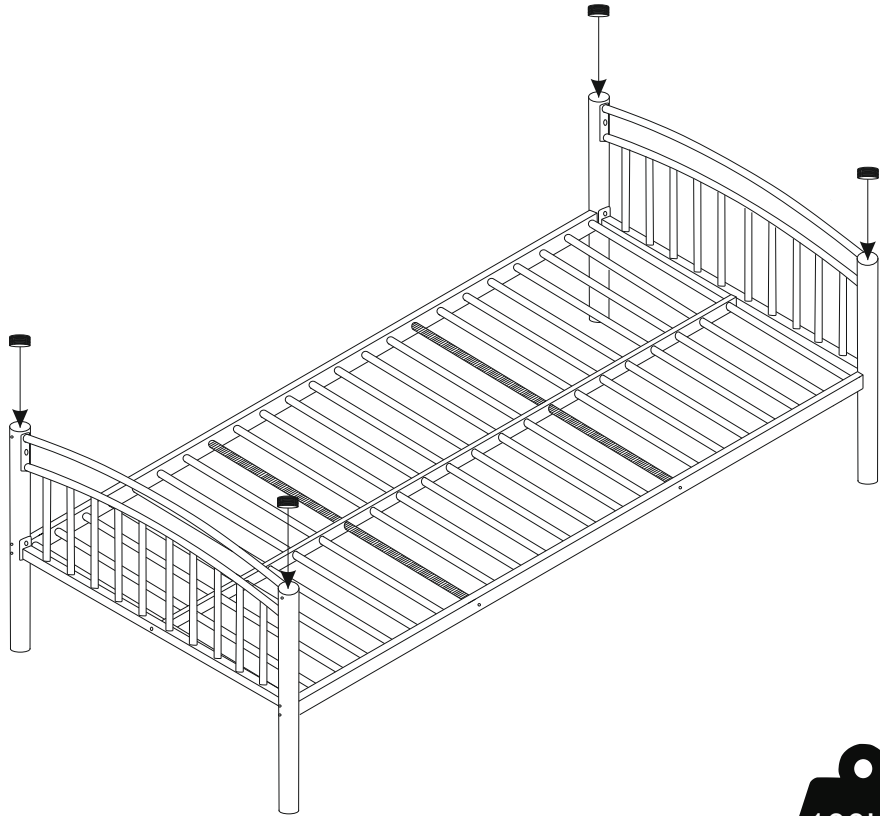

**BOTTOM BUNK
MAX WEIGHT**

STEP 16

PARTS REQUIRED

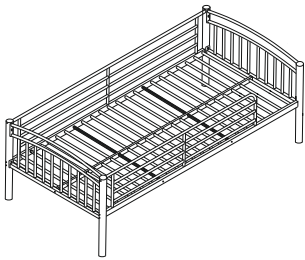

HARDWARE REQUIRED

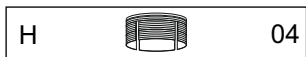

TOOLS REQUIRED

THE BUNK BED CAN BE SPLIT INTO TWO SINGLE BEDS.

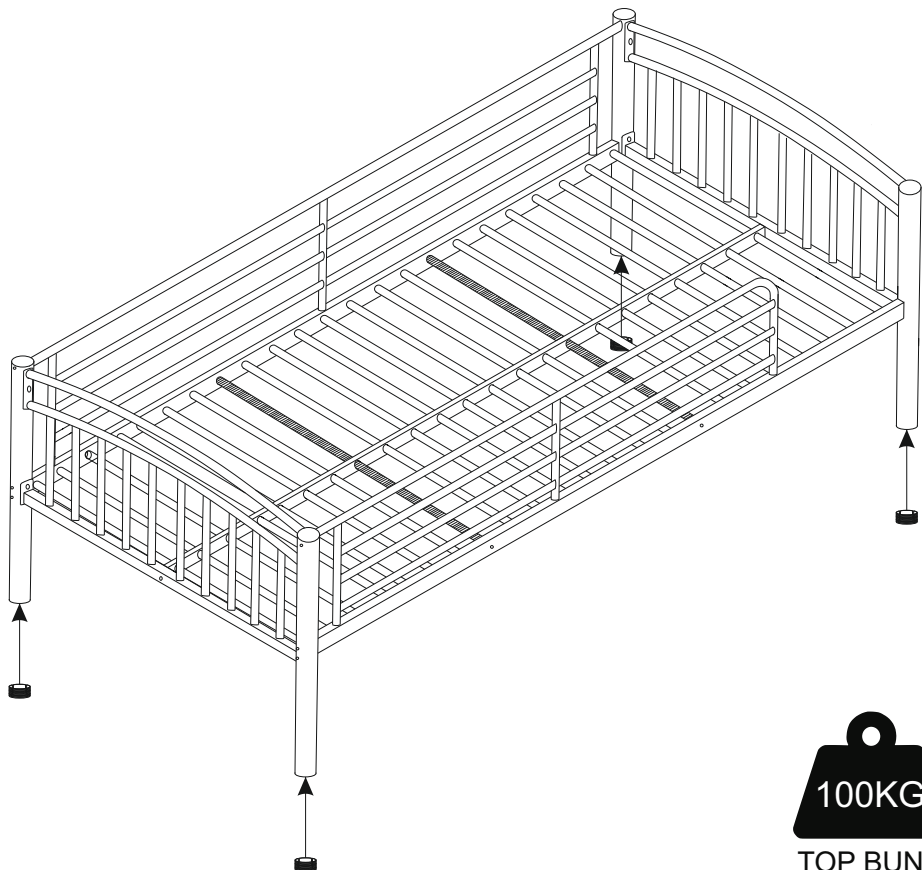

**TOP BUNK
MAX WEIGHT**