

WHITE BRANDON 3' BUNK BED ASSEMBLY INSTRUCTIONS



100KG
TOP BUNK
MAX WEIGHT



100KG
BOTTOM BUNK
MAX WEIGHT

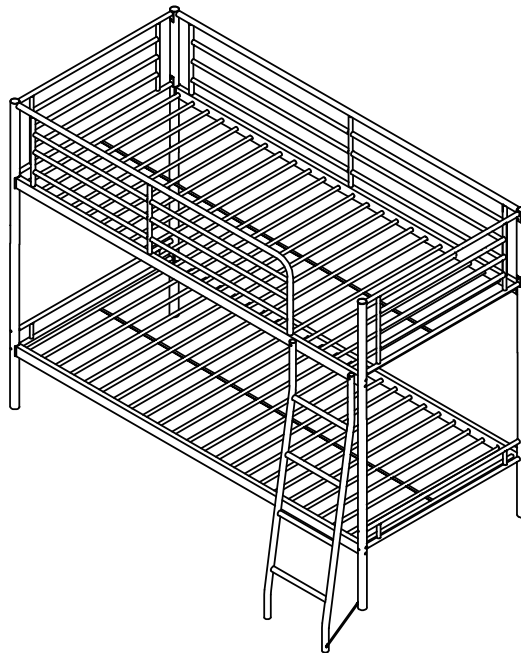

IMPORTANT **FOR DOMESTIC USE ONLY** **PLEASE READ AND FOLLOW THESE INSTRUCTIONS CAREFULLY** **RETAIN FOR FUTURE REFERENCE**

- a) WARNING "High beds and the upper bed of bunk beds are not suitable for children under six years due to the risk of injury from falls";
- b) WARNING "Bunk beds and high beds can present a serious risk of injury from strangulation if not used correctly.
Never attach or hang items to any part
of the bunk bed that are not designed to be used with the bed, for example, but not limited to ropes, strings, cords, hooks, belts and bags";
- c) WARNING "Children can become trapped between the bed and the wall, a roof pitch, the ceiling, adjoining pieces of furniture (e.g. cupboards) and the like.
To avoid risk of serious injury the distance between the top safety barrier and the adjoining structure shall not exceed 75 mm or shall be more than 230 mm";
- d) WARNING Do not use the bunk bed/high bed if any structural part is broken or missing;
- e) always follow the manufacturer's instructions;
- f) the recommended size of the mattress(es): 1900*900*160mm;
- g) ventilation of the room is necessary in order to keep the humidity low and to prevent mould in and around the bed;
- h) instructions regarding positioning and connection of the means of access;
-The ladder is not for playing on, only use to climb onto top bunk.
-We recommend only one person on the upper bunk at one time.
- i) the maximum thickness of the mattress (see 4.1.4) as well as information regarding the mattress maximum thickness marking;
- The top of the mattress shall be at least 160mm below the upper edge of the safety barriers.
- j) check regularly that all assembly fastenings are properly tightened;

EN747 - 1 & 2 : 2012 + A1 : 2015 TESE version

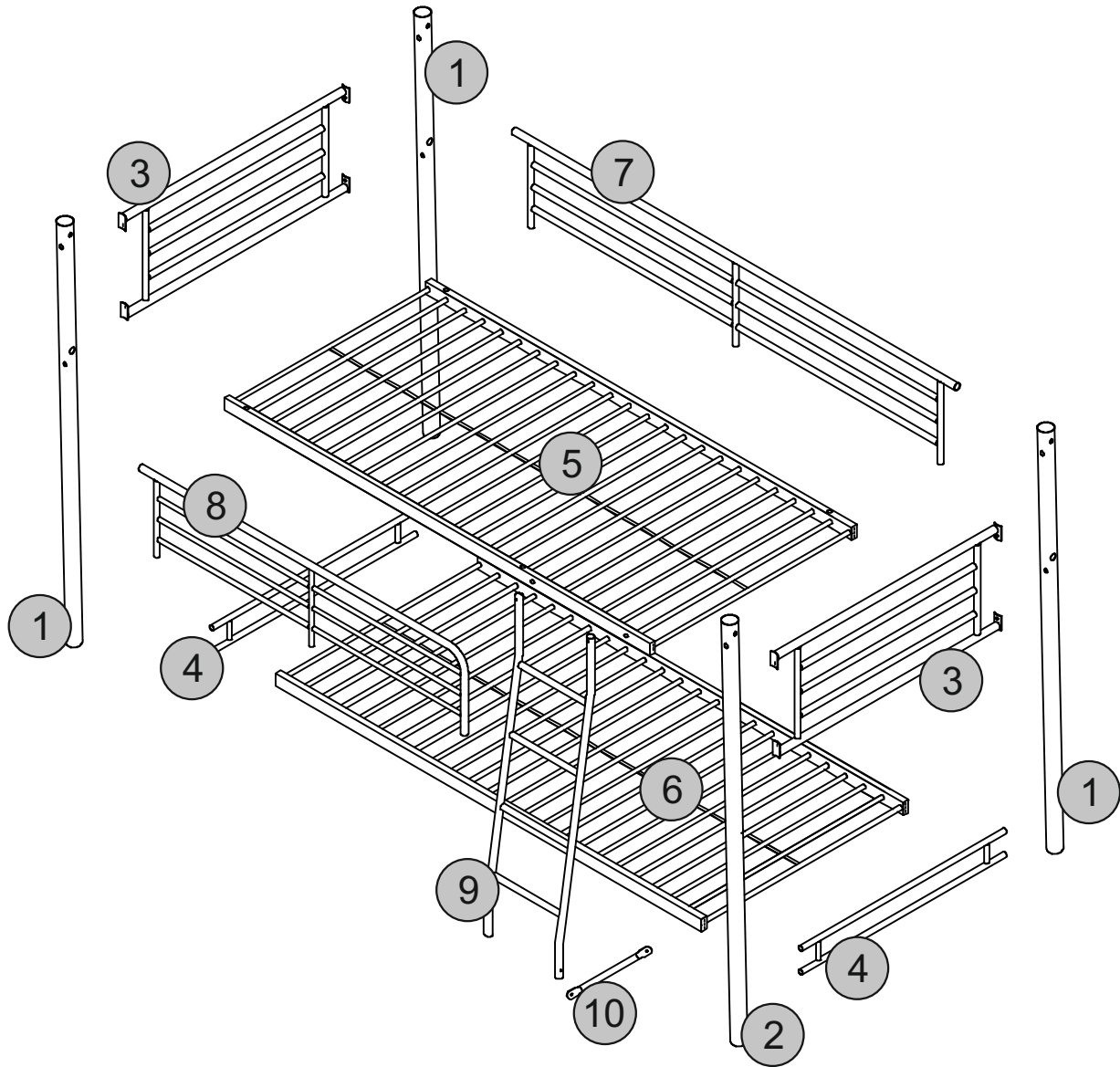









PLEASE NOTE: UPPER BASE **5** HAS HOLES FOR ASSEMBLY OF LADDER AND SAFETY RAILS

PLEASE CHECK THAT YOU HAVE ALL THE PARTS LISTED BEFORE YOU START ASSEMBLING. IF YOU DO FIND THAT SOMETHING IS MISSING, DO NOT CONTINUE ASSEMBLY. PLEASE CONTACT YOUR SUPPLIER IMMEDIATELY.

PARTS LIST

Part Number	Part Code	Part Description	Quantity	Carton
1	S200-205-021-RJ1-01	Posts (with safety rail holes)	3	1
2	S200-205-021-RJ1-02	Front Right Post	1	1
3	S200-205-021-RJ1-03	Upper Headboard and Footboard	2	1
4	S200-205-021-RJ1-04	Lower Support Bar	2	1
5	S200-205-021-RJ1-05	Upper Base	1	1
6	S200-205-021-RJ1-06	Lower Base	1	1
7	S200-205-021-RJ1-07	Back Safety Rail	1	1
8	S200-205-021-RJ1-08	Front Safety Rail	1	1
9	S200-205-021-RJ1-09	Ladder	1	1
10	S200-205-021-RJ1-10	Ladder Support Bar	1	1

HARDWARE LIST

REF		HARDWARE NAME	QTY
A		M6 x 15mm Bolt	10PCS
B		M6 x 35mm Bolt	2PCS
C		M6 x 45mm Bolt	11PCS
D		M6 x 55mm Bolt	6PCS
E		M8 x 45mm Bolt	16PCS
F		Nut	2PCS
G		Washer M6	11PCS
H		Washer M8	16PCS
I		Allen Key M4	2PCS

PLEASE CHECK THAT YOU HAVE ALL THE PARTS LISTED BEFORE YOU START ASSEMBLING. IF YOU DO FIND THAT SOMETHING IS MISSING, DO NOT CONTINUE ASSEMBLY. PLEASE CONTACT YOUR SUPPLIER IMMEDIATELY.

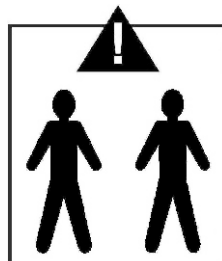

TWO PEOPLE ARE NEEDED TO ASSEMBLE THIS BUNK BED.

STEP 1

PARTS REQUIRED

1 - POSTS (WITH SAFETY RAIL HOLES) x1

2 - FRONT RIGHT POST x1

3 - UPPER HEADBOARD AND FOOTBOARD x1

4 - LOWER SUPPORT BAR x1

HARDWARE REQUIRED





A  04

C  04

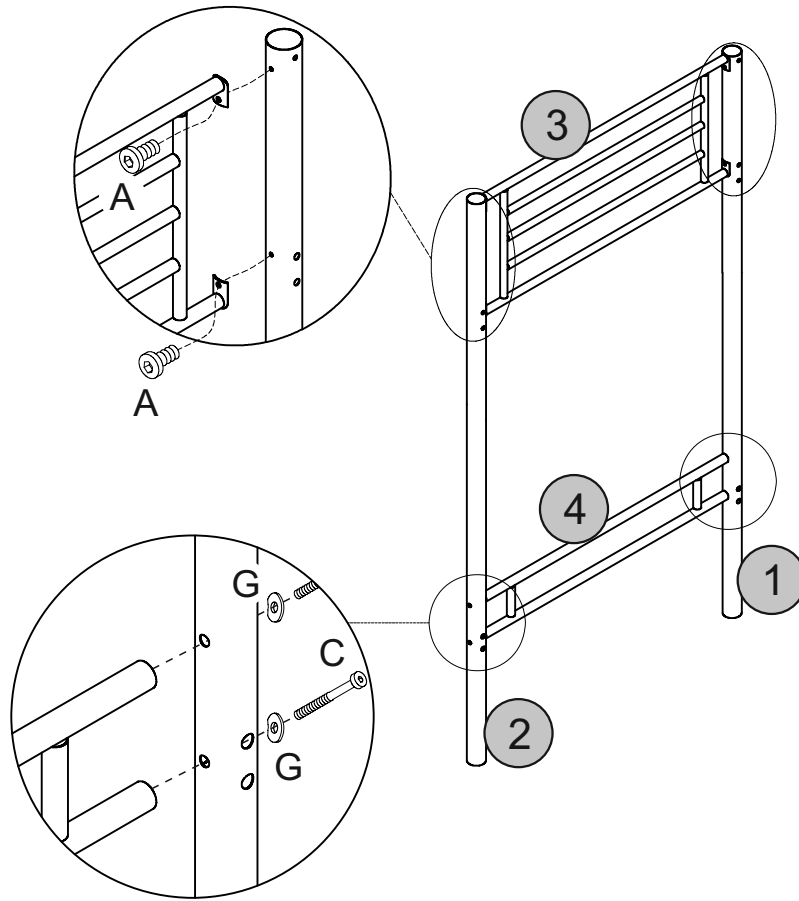
G  04

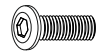
TOOLS REQUIRED



-  M6x15mm
- ~~ M6x35mm~~
-  M6x45mm
- ~~ M6x55mm~~
- ~~ M8x45mm~~

STEP 2

PARTS REQUIRED

1 - POSTS (WITH SAFETY RAIL HOLES) x2

3 - FRONT RIGHT POST x1

4 - LOWER SUPPORT BAR x1

HARDWARE REQUIRED





A  04

C  04

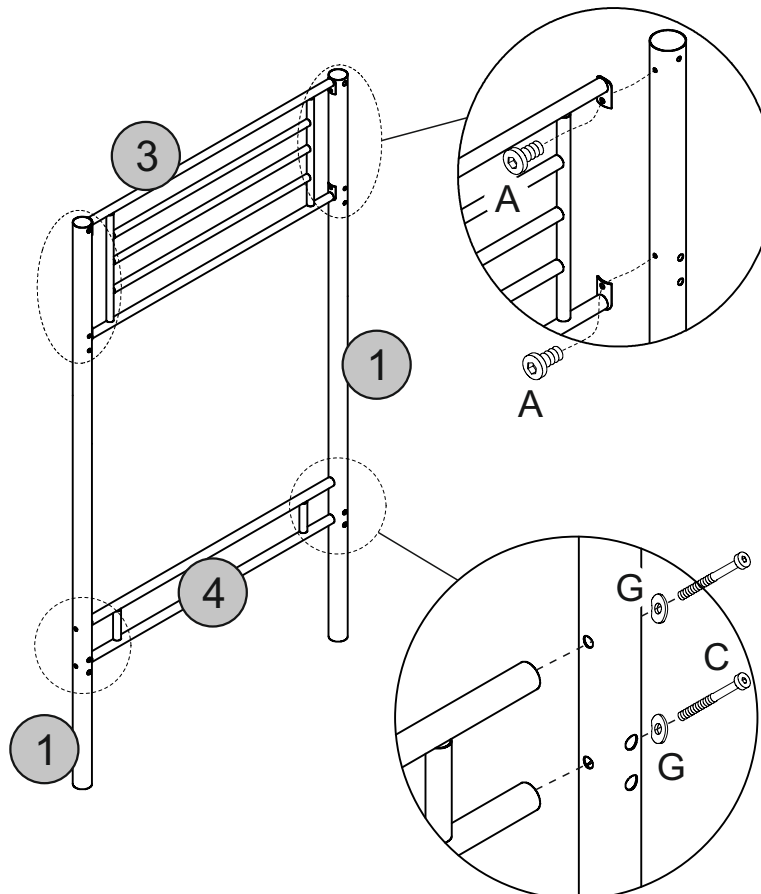
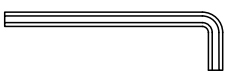
G  04

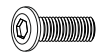
TOOLS REQUIRED



-  M6x15mm
- ~~ M6x35mm~~
-  M6x45mm
- ~~ M6x55mm~~
- ~~ M8x45mm~~

STEP 3

PARTS REQUIRED

6 - LOWER BASE x1

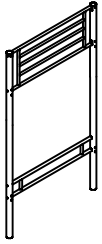





HARDWARE REQUIRED

E  04

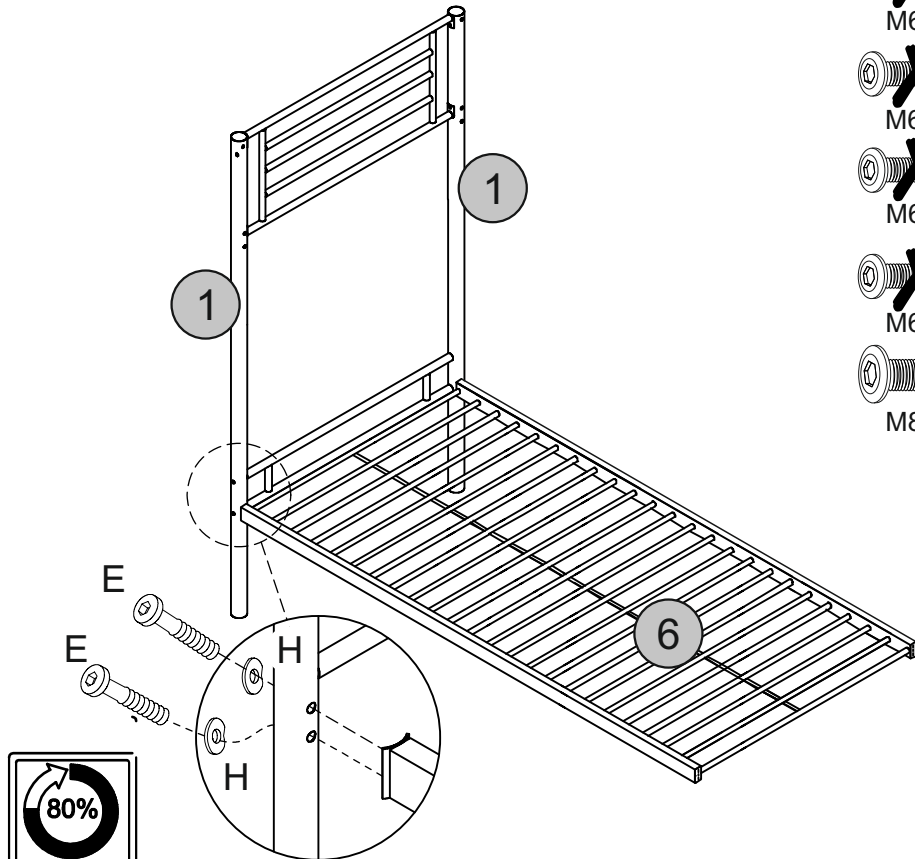
H  04

TOOLS REQUIRED

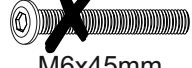

-  M6x15mm
-  M6x35mm
-  M6x45mm
-  M6x55mm
-  M8x45mm

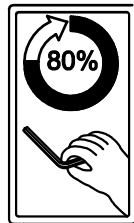

DO NOT FULLY TIGHTEN THE BOLTS AT THIS STAGE !!

STEP 4

PARTS REQUIRED

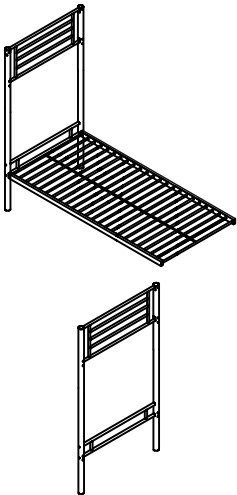





HARDWARE REQUIRED

E  04

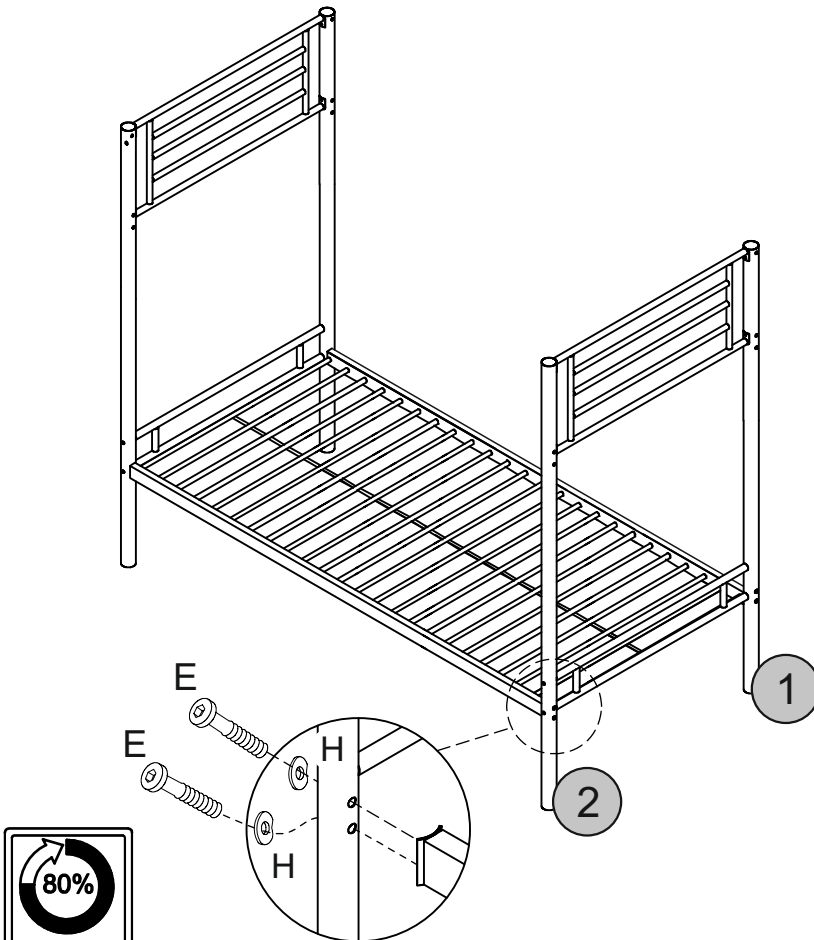
H  04

TOOLS REQUIRED

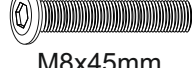

-  M6x15mm
-  M6x35mm
-  M6x45mm
-  M6x55mm
-  M8x45mm

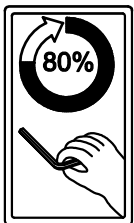

DO NOT FULLY TIGHTEN THE BOLTS AT THIS STAGE !!

STEP 5

PARTS REQUIRED

5 - UPPER BASE x1

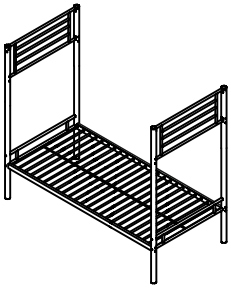

HARDWARE REQUIRED

E  08

H  08

TOOLS REQUIRED





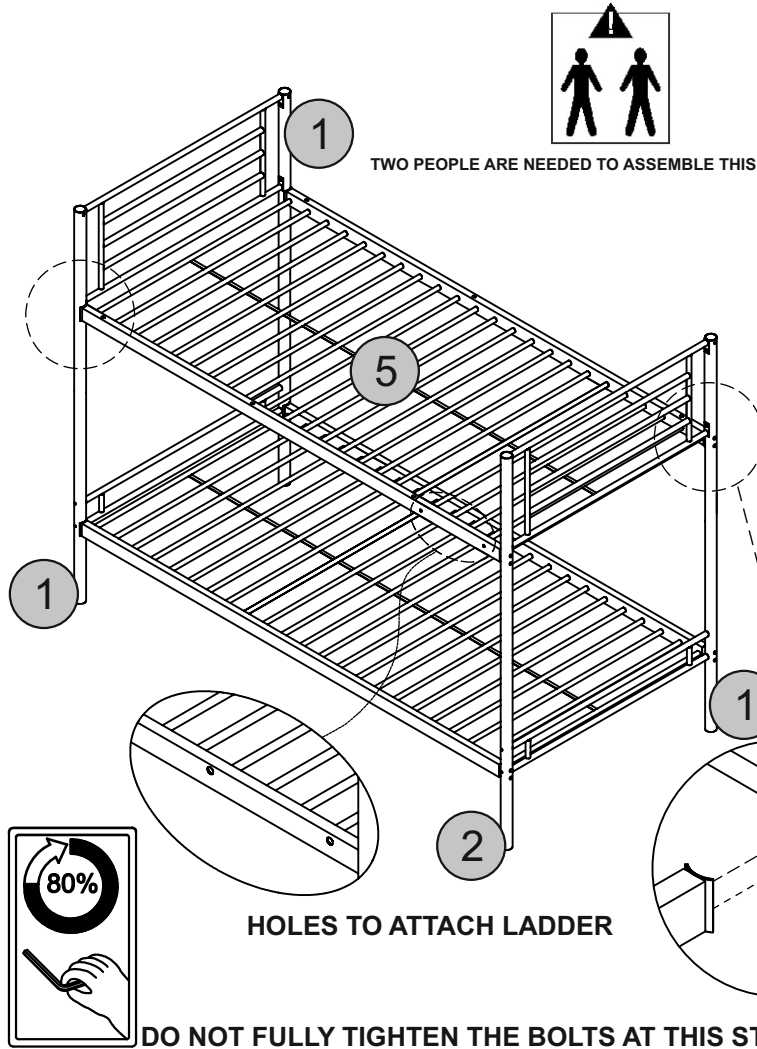



TWO PEOPLE ARE NEEDED TO ASSEMBLE THIS BUNK BED.



HOLES TO ATTACH LADDER

DO NOT FULLY TIGHTEN THE BOLTS AT THIS STAGE !!

-  M6x15mm
-  M6x35mm
-  M6x45mm
-  M6x55mm
-  M8x45mm

STEP 6

PARTS REQUIRED

7 - BACK SAFETY RAIL x1

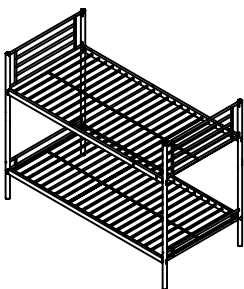

HARDWARE REQUIRED

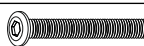
C  02

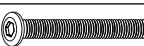
D  03

G  02





TOOLS REQUIRED

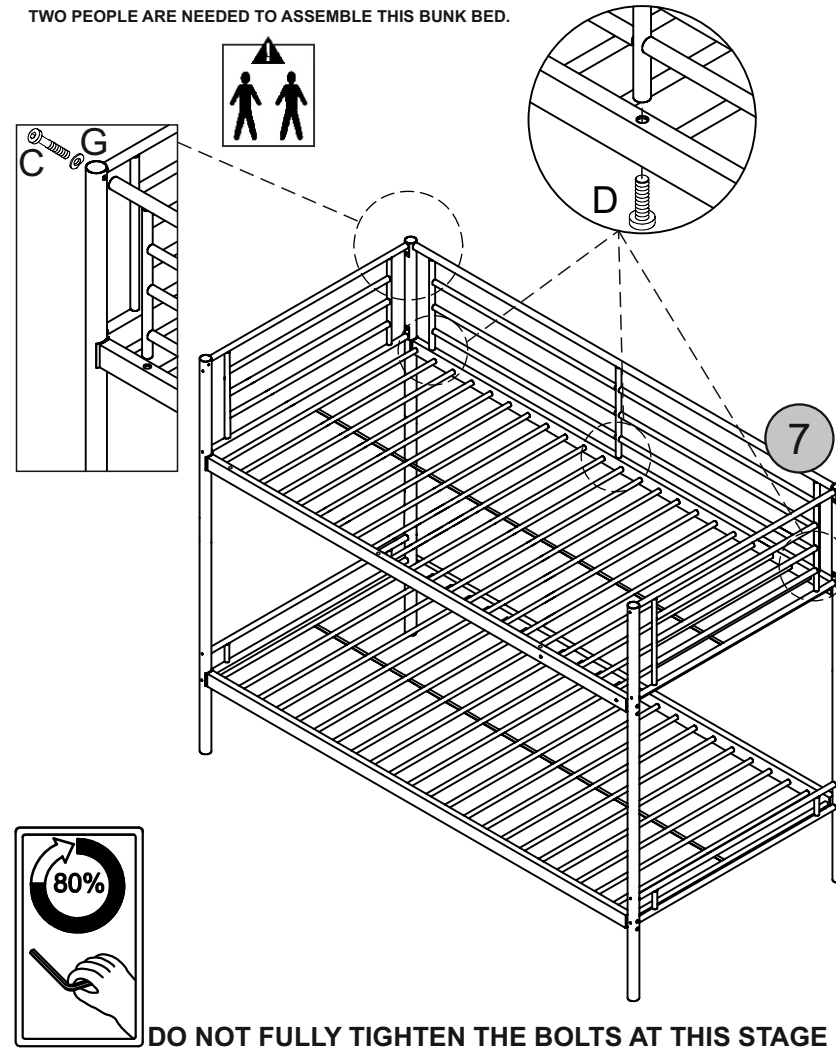

TWO PEOPLE ARE NEEDED TO ASSEMBLE THIS BUNK BED.



DO NOT FULLY TIGHTEN THE BOLTS AT THIS STAGE !!

-  M6x15mm
-  M6x35mm
-  M6x45mm
-  M6x55mm
-  M8x45mm

STEP 7

PARTS REQUIRED

8 - FRONT SAFETY RAIL x1

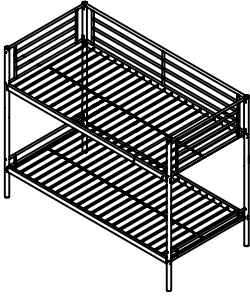

HARDWARE REQUIRED

C  01

D  03

G  01

TOOLS REQUIRED

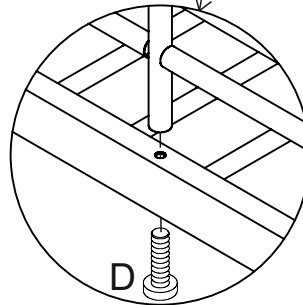
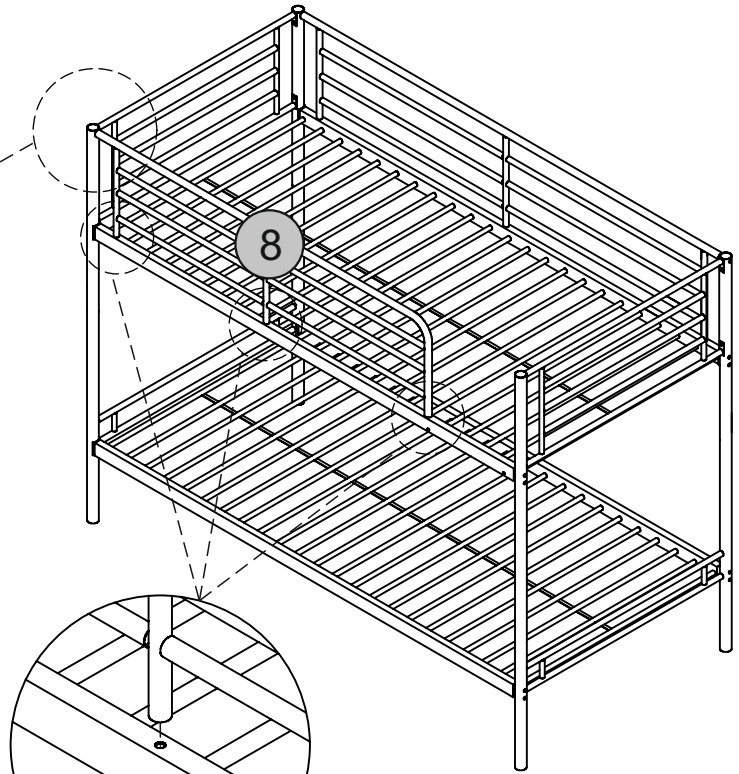
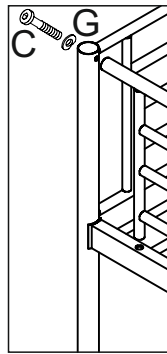

~~~~
M6x15mm

~~~~
M6x35mm

M6x45mm

M6x55mm

~~~~
M8x45mm

DO NOT FULLY TIGHTEN THE BOLTS AT THIS STAGE !!

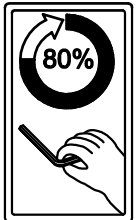

STEP 8

PARTS REQUIRED

9 - LADDER x1

10 - LADDER SUPPORT BAR x1

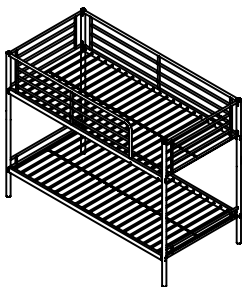

HARDWARE REQUIRED

A  02

B  02

F  02

TOOLS REQUIRED

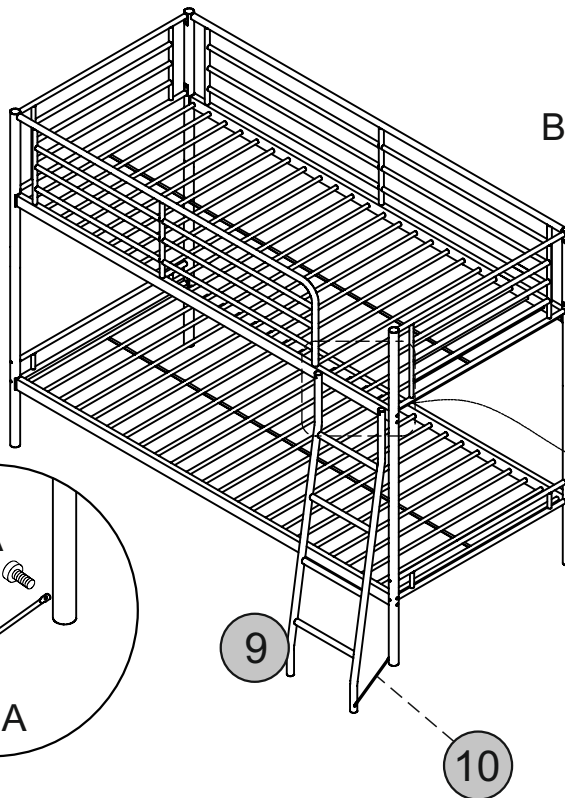
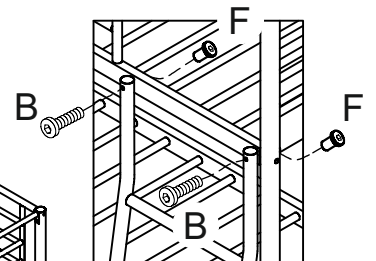
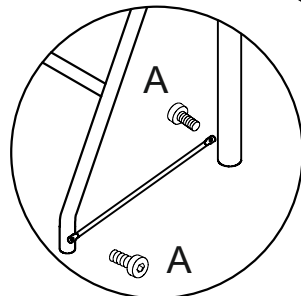
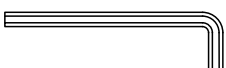

NOW FULLY TIGHTEN ALL THE BOLTS !!

M6x15mm

M6x35mm

~~~~
M6x45mm

~~~~
M6x55mm

~~~~
M8x45mm

STEP 9

PARTS REQUIRED

HARDWARE REQUIRED

TOOLS REQUIRED

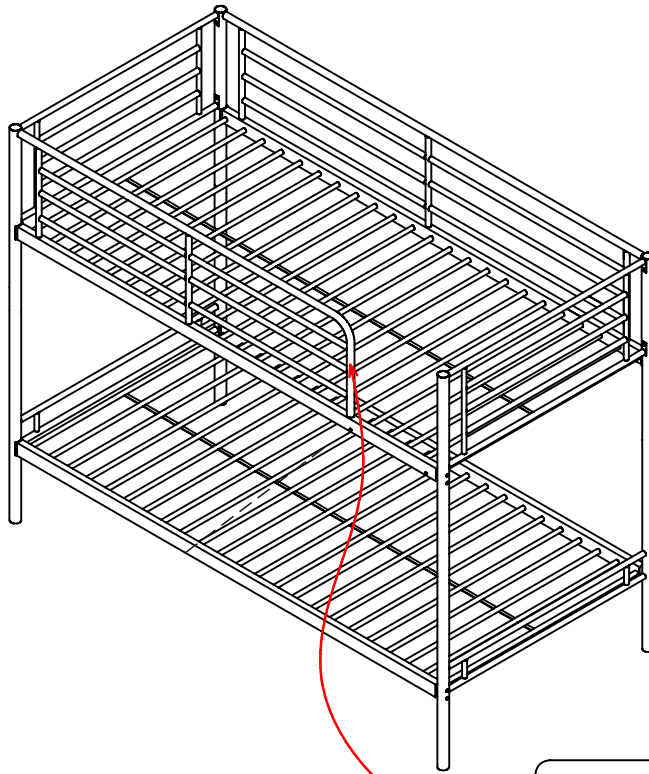

WARNING

THE MATTRESS SURFACE SHOULD NOT BE ABOVE THIS LINE

STEP 10

PARTS REQUIRED

HARDWARE REQUIRED

TOOLS REQUIRED

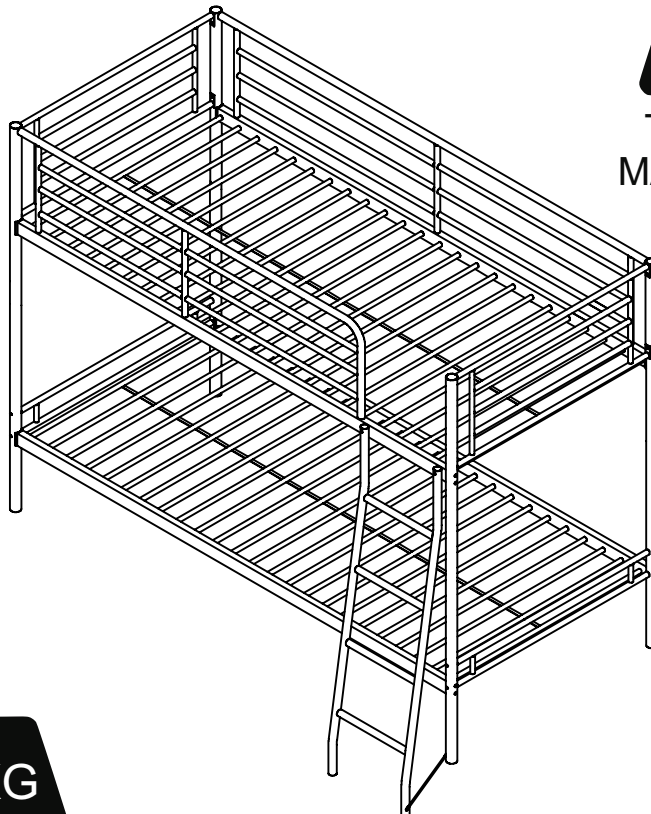

TOP BUNK
MAX WEIGHT



BOTTOM BUNK
MAX WEIGHT