

# GREY SLATE PANAMA MID SLEEPER ASSEMBLY INSTRUCTIONS

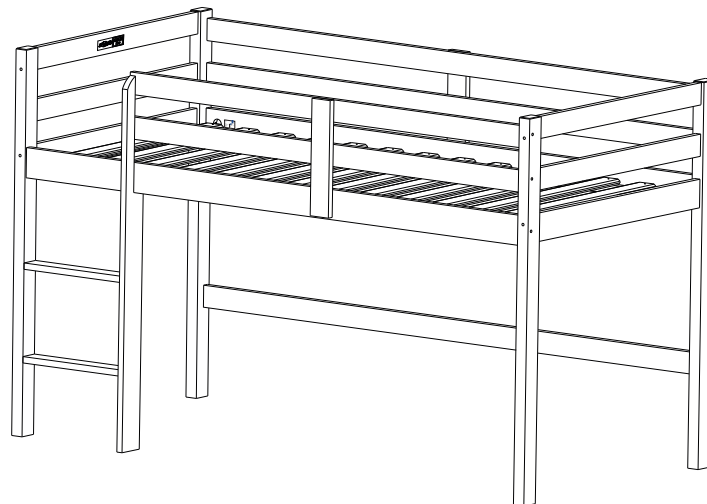

**FOR DOMESTIC USE ONLY  
IMPORTANT**

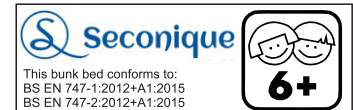

**READ CAREFULLY  
RETAIN FOR FUTURE REFERENCE  
CARE AND MAINTENANCE**

**WARNING** “High beds and the upper bed of bunk beds are not suitable for children under six years due to the risk of injury from falls”.

**WARNING** “Bunk beds and high beds can present a serious risk of injury from strangulation if not used correctly. Never attach or hang items to any part of the bunk bed that are not designed to be used with the bed, for example, but not limited to; ropes, strings, cords, hooks, belts and bags”.

**WARNING** “Children can become trapped between the bed and the wall, a roof pitch, the ceiling, adjoining pieces of furniture (e.g. cupboards) and the like. To avoid risk of serious injury the distance between the top safety barrier and the adjoining structure shall not exceed 75mm or shall be more than 230mm”.

**WARNING** Do not use the bunk bed/high bed if any structural part is broken or missing.

The recommended mattress size for this bunk bed is 1900mm x 915mm x 150mm.

The maximum mattress height is 160mm.

The maximum mattress height is clearly marked on the bunk bed and **MUST NOT BE EXCEEDED**.

Depending on the amount of use this product receives it may be necessary to tighten up the fixings from time to time, this is completely normal for all flat pack furniture. **DO NOT OVER TIGHTEN FIXINGS**. Do not for any reason use a power tool to assemble this product.

Two persons are required to assemble this bunk bed.

Assemble as close to its final position as possible.

Assemble on a soft clean surface.

For cleaning you may use a damp cloth (not wet).

The room in which the bed is positioned should be ventilated to prevent mould in and around the bed.

This bunk bed is manufactured to conform to BS EN 747:2012+A1:2015

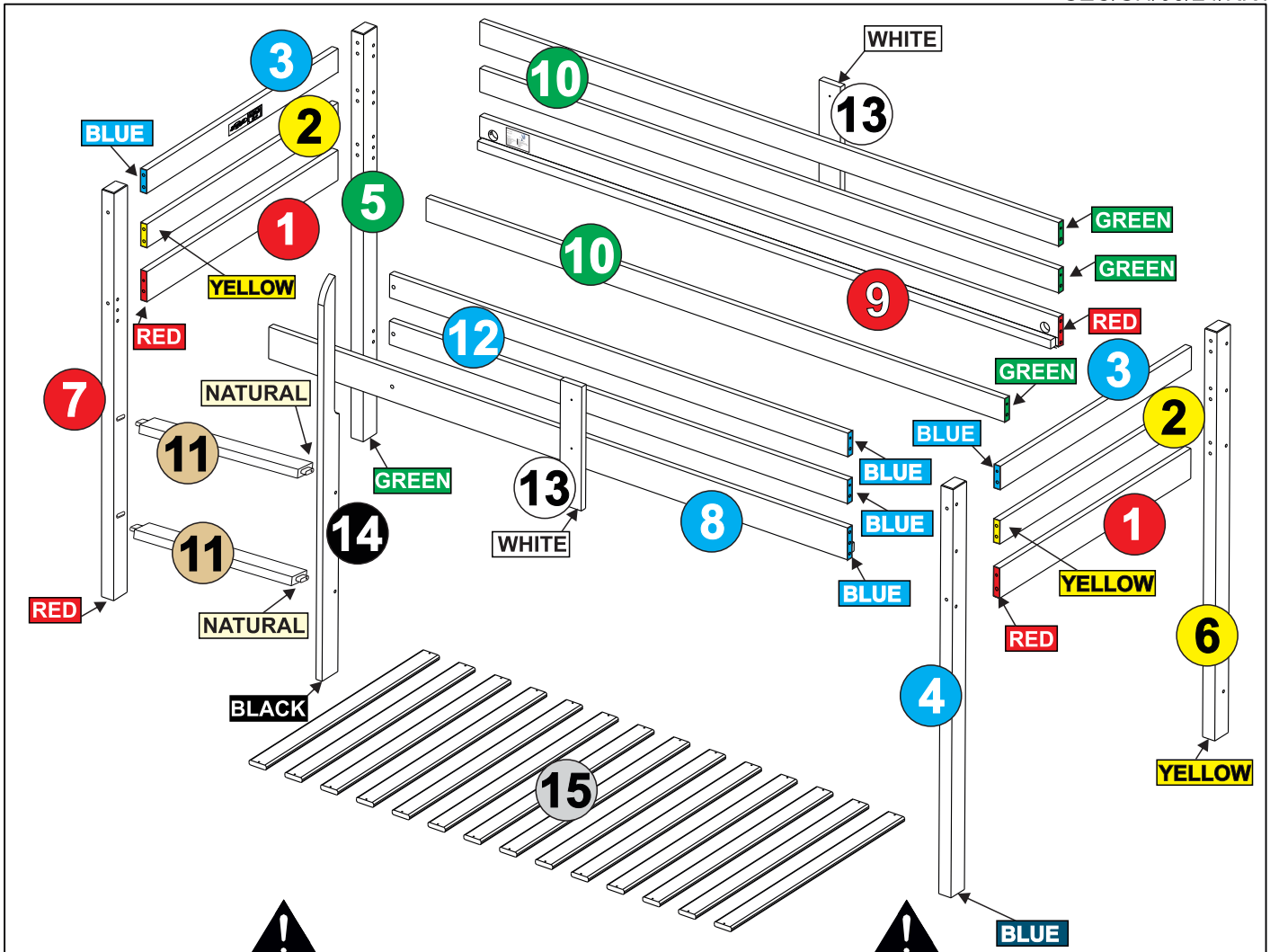

!   
 \* Use of power tools to assemble this product will invalidate any claim and damage this product making it unsafe !!!   
 \* Please assemble on a clean soft surface to avoid damage.







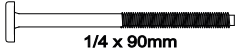

!   
 \* Please check contents and read the instructions before commencing assembly.   
 \* Assemble this product following the enclosed instructions carefully.   
 \* Please take care to avoid damaging panels during assembly.

### PARTS LIST

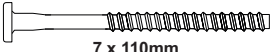
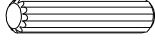
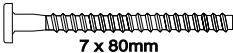
**Please Note:**  
 The parts below have been stamped with the part number/colour to help identify them during assembly.

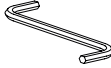
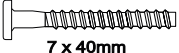
Part Number	Part Code	Part Description	Quantity	Carton
1	S200-206-012-KK1-01	Large Headboard Panel (RED)	2	1/2
2	S200-206-012-KK1-02	Small Headboard Panel (YELLOW)	2	1/2
3	S200-206-012-KK1-03	Top Headboard Panel (BLUE)	2	1/2
4	S200-206-012-KK1-04	Front Right Post (BLUE)	1	2/2
5	S200-206-012-KK1-05	Back Left Post (GREEN)	1	2/2
6	S200-206-012-KK1-06	Back Right Post (YELLOW)	1	2/2
7	S200-206-012-KK1-07	Front Left Post (Ladder Side) (RED)	1	2/2
8	S200-206-012-KK1-08	Front Side Rail (With Holes) (BLUE)	1	1/2
9	S200-206-012-KK1-09	Back Side Rail (RED)	1	1/2
10	S200-206-012-KK1-10	Back Support/Long Safety Rail (GREEN)	3	1/2
11	S200-206-012-KK1-11	Ladder Steps (NATURAL)	2	2/2
12	S200-206-012-KK1-12	Short Safety Rail (BLUE)	2	1/2
13	S200-206-012-KK1-13	Support Brace (WHITE)	2	1/2
14	S200-206-012-KK1-14	Ladder Upright (BLACK)	1	2/2
15	S200-206-012-KK1-15	Slats	14	2/2

## FITTINGS

<b>A</b>	 1/4 x 90mm	<b>04</b>	<b>F</b>	<sup>+2</sup>	 3.5 x 25mm	<b>28</b>
<b>B</b>	 7 x 110mm	<b>08</b>	<b>G</b>	<sup>+2</sup>	 8 x 30mm	<b>33</b>
<b>C</b>	 7 x 80mm	<b>08</b>	<b>H</b>	<sup>+1</sup>	 3.5 x 30mm	<b>07</b>
<b>D</b>	 7 x 60mm	<b>02</b>	<b>I</b>			<b>01</b>
<b>E</b>	 7 x 40mm	<b>05</b>	<b>J</b>	<sup>+1</sup>		<b>04</b>
<b>L</b>	 72mm (WOODEN) (SPACER)	<b>02</b>	<b>K</b>		 GLUE	<b>02</b>

## TOOLS REQUIRED

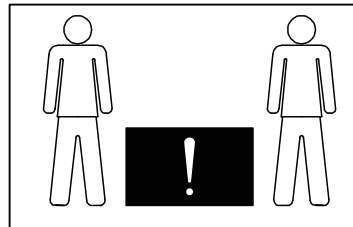
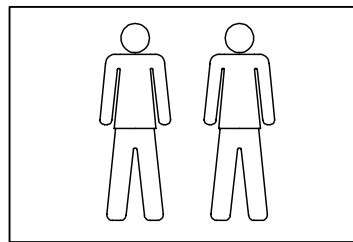
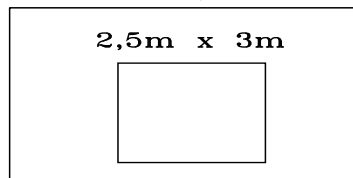
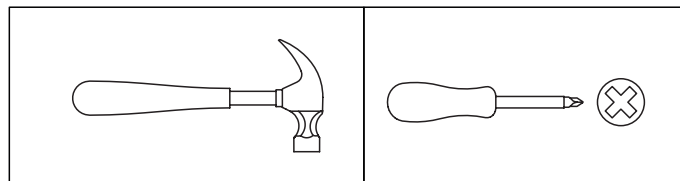

# STEP 1

## PARTS REQUIRED

- 1 - LARGE HEADBOARD PANEL (RED) x2
- 2 - SMALL HEADBOARD PANEL (YELLOW) x2
- 3 - TOP HEADBOARD PANEL (BLUE) x2
- 10 - BACK RAIL (GREEN) x1

## HARDWARE REQUIRED

G  18  
8 x 30mm

K  01  
GLUE

## TOOLS REQUIRED

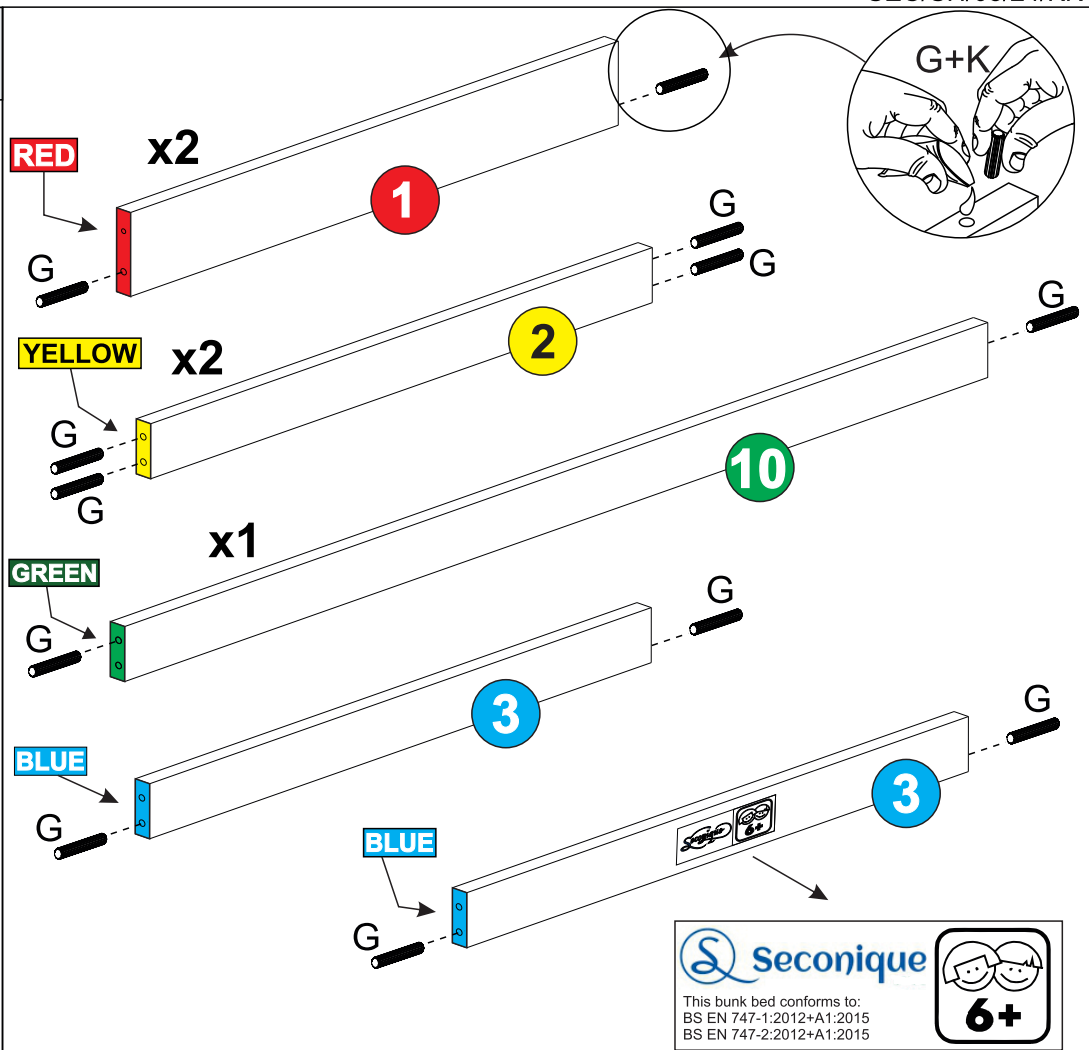

# STEP 2

## PARTS REQUIRED

- 1 - LARGE HEADBOARD PANEL (RED) x1
- 2 - SMALL HEADBOARD PANEL (YELLOW) x1
- 3 - TOP HEADBOARD PANEL (BLUE) x1
- 5 - BACK LEFT/Front RIGHT POST (GREEN) x1
- 7 - FRONT LEFT POST (LADDER SIDE) (RED) x1

## HARDWARE REQUIRED

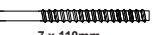
B  04  
7 x 110mm

K  01  
GLUE

## TOOLS REQUIRED

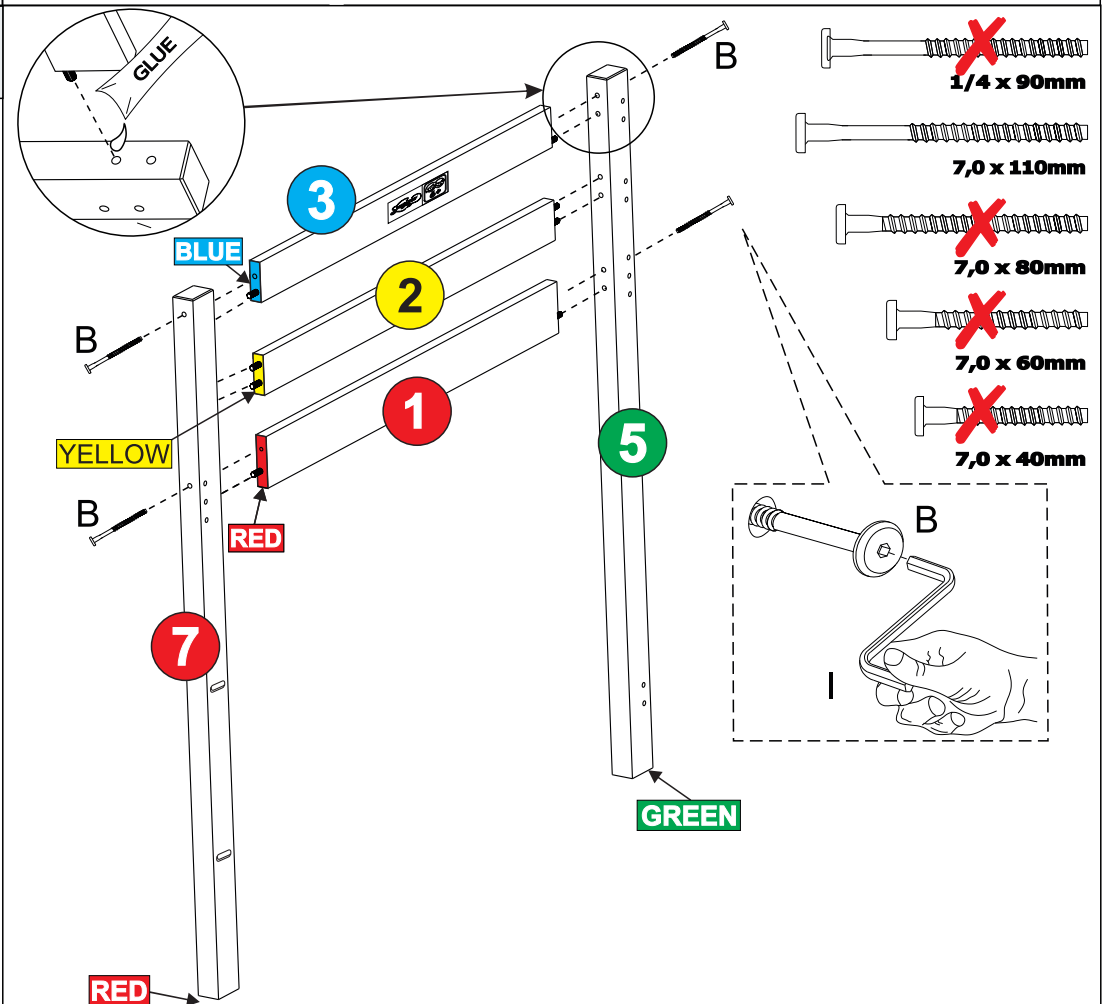
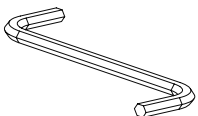



# STEP 3

## PARTS REQUIRED

- 1 - LARGE HEADBOARD PANEL (RED) x1
- 2 - SMALL HEADBOARD PANEL (YELLOW) x1
- 3 - TOP HEADBOARD PANEL (BLUE) x1
- 4 - BACK LEFT/FRONT RIGHT POST (BLUE) x1
- 6 - BACK RIGHT POST (YELLOW) x1

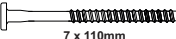
## HARDWARE REQUIRED

- B  04  
7 x 110mm
- K  01

## TOOLS REQUIRED

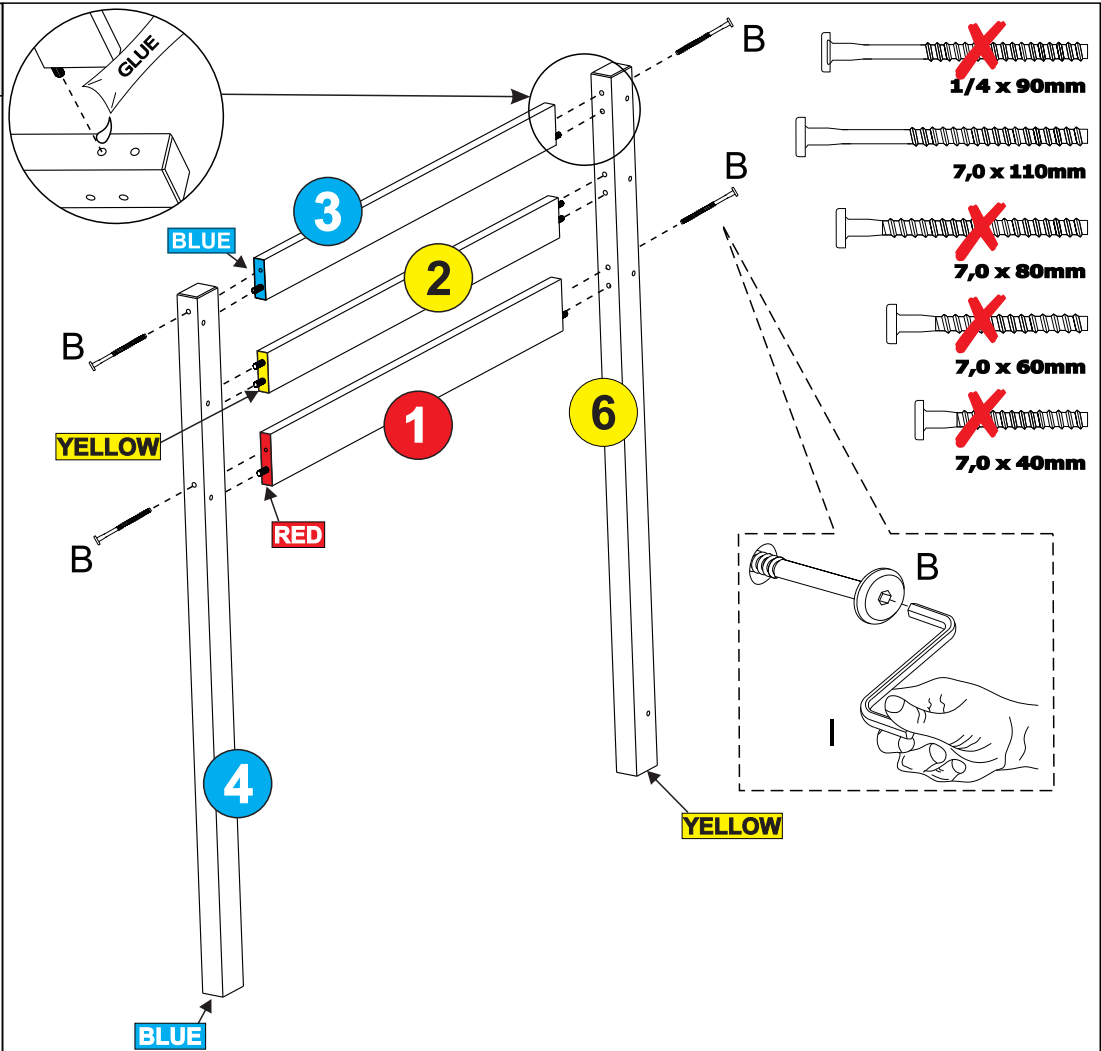
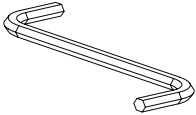



# STEP 4

## PARTS REQUIRED

- 8 - FRONT SIDE RAIL (WITH HOLES) (BLUE) x1
- 9 - BACK SIDE RAIL (RED) x1

## HARDWARE REQUIRED

- G  08  
8 x 30mm
- K  01

## TOOLS REQUIRED

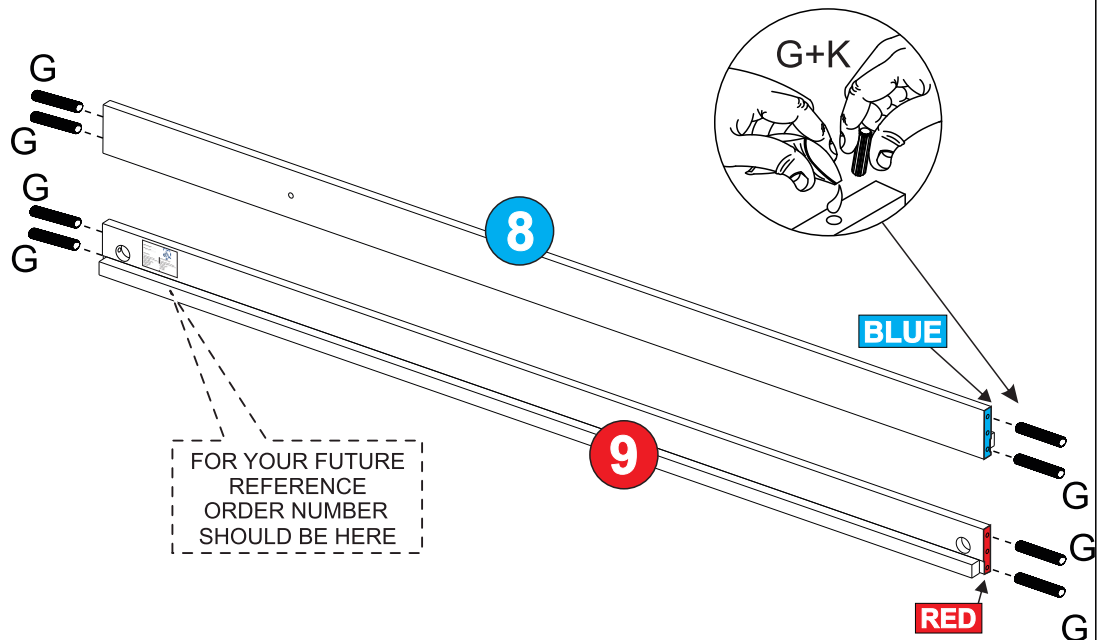

# STEP 5

## PARTS REQUIRED

- 9 - BACK SIDE RAIL (RED) x1
- 10 - BACK RAIL (GREEN) x1

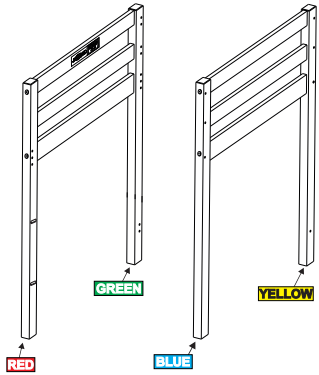

## HARDWARE REQUIRED

- A 1/4 x 90mm 02
- C 7 x 80mm 02
- J 02

## TOOLS REQUIRED

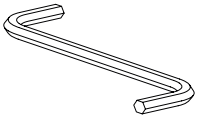

 2 persons required for this step.

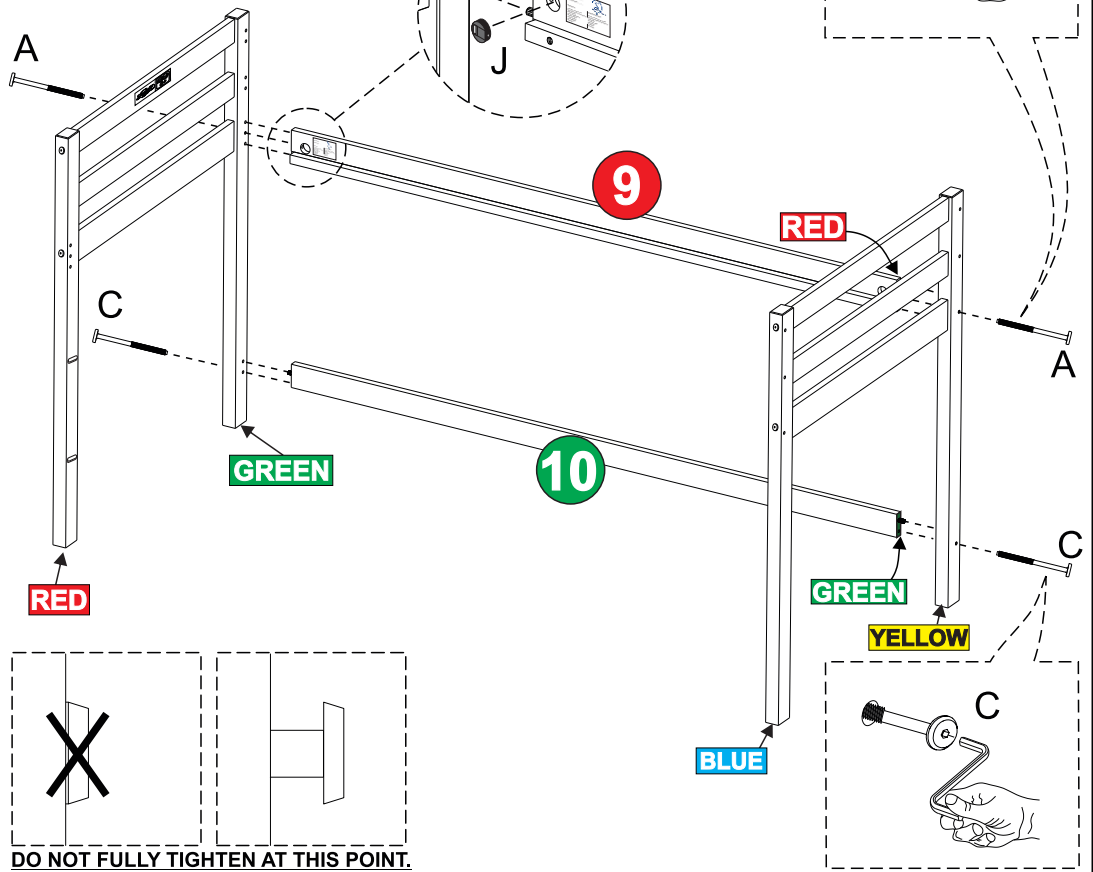

# STEP 6

## PARTS REQUIRED

- 8 - FRONT SIDE RAIL (WITH HOLES) (BLUE) x1

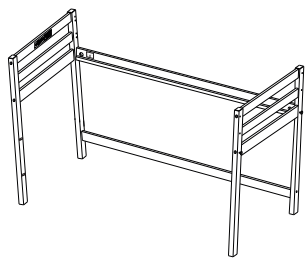

## HARDWARE REQUIRED

- A 1/4 x 90mm 02
- J 02

## TOOLS REQUIRED

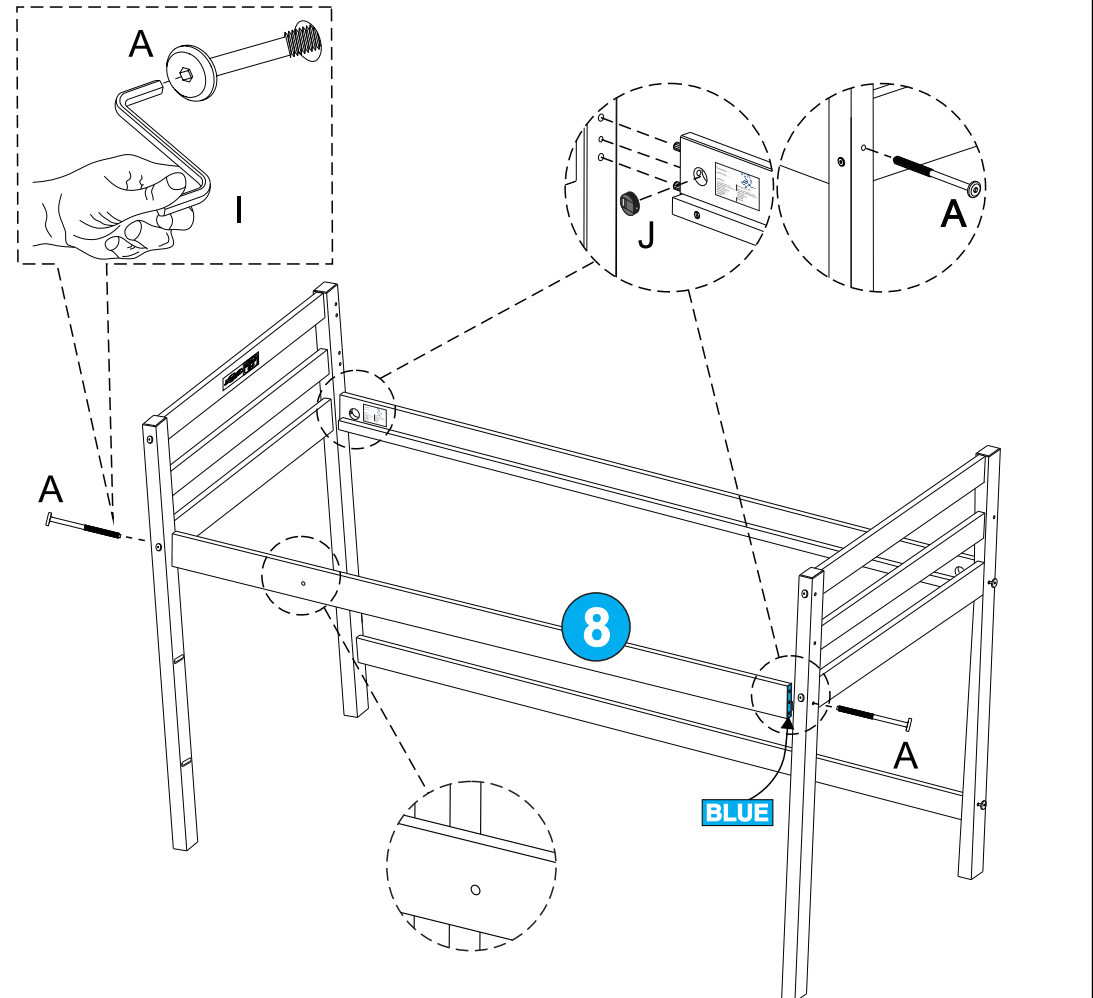
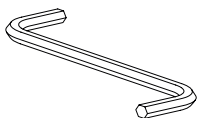

# STEP 7

## PARTS REQUIRED

10 - LONG SAFETY RAIL (GREEN) x2

## HARDWARE REQUIRED

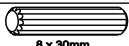
G  04  
8 x 30mm

K  01  
GLUE

## TOOLS REQUIRED

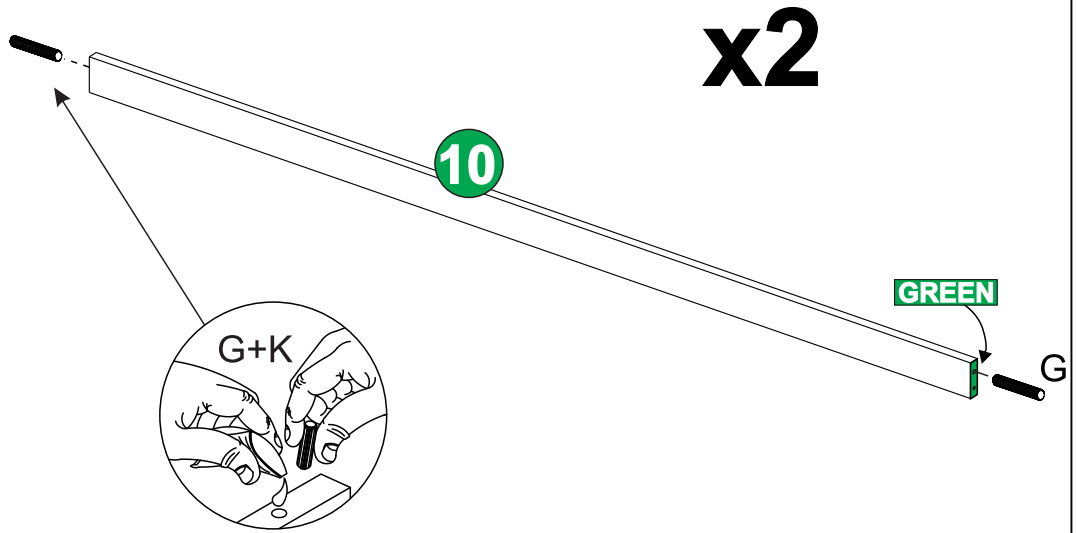

# STEP 8

## PARTS REQUIRED

10- LONG SAFETY RAIL (GREEN) x2

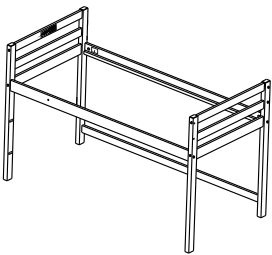

## HARDWARE REQUIRED

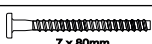
C  04  
7 x 80mm

## TOOLS REQUIRED

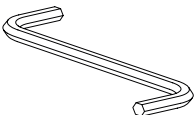

Gently part the ends of the bed to attach part 10 (x2)

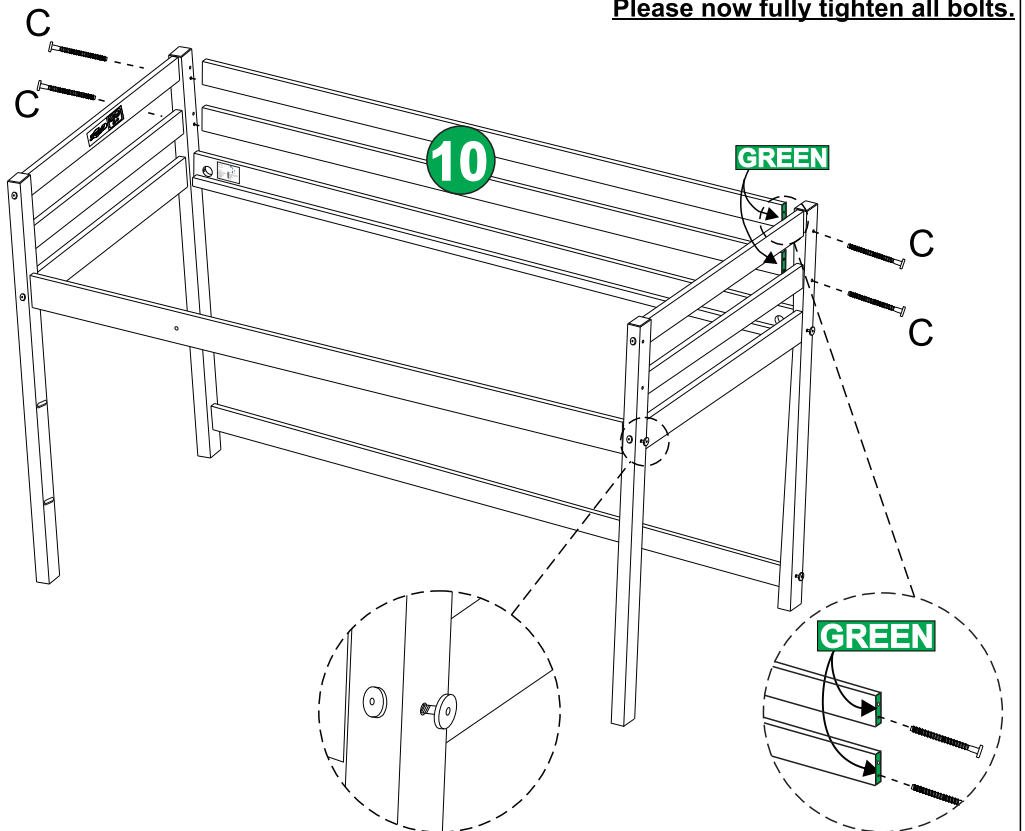
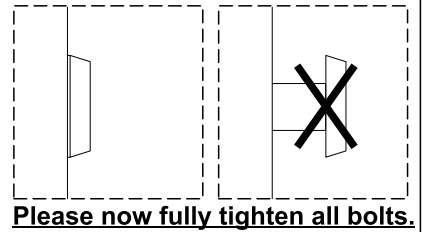





# STEP 9

## PARTS REQUIRED

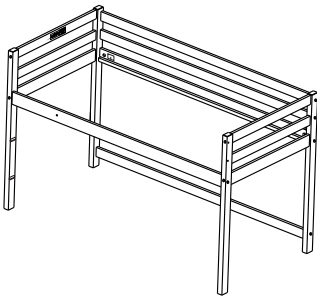
15 - SLATS x14



## HARDWARE REQUIRED

F  28  
3.5 x 25mm

L  02

## TOOLS REQUIRED

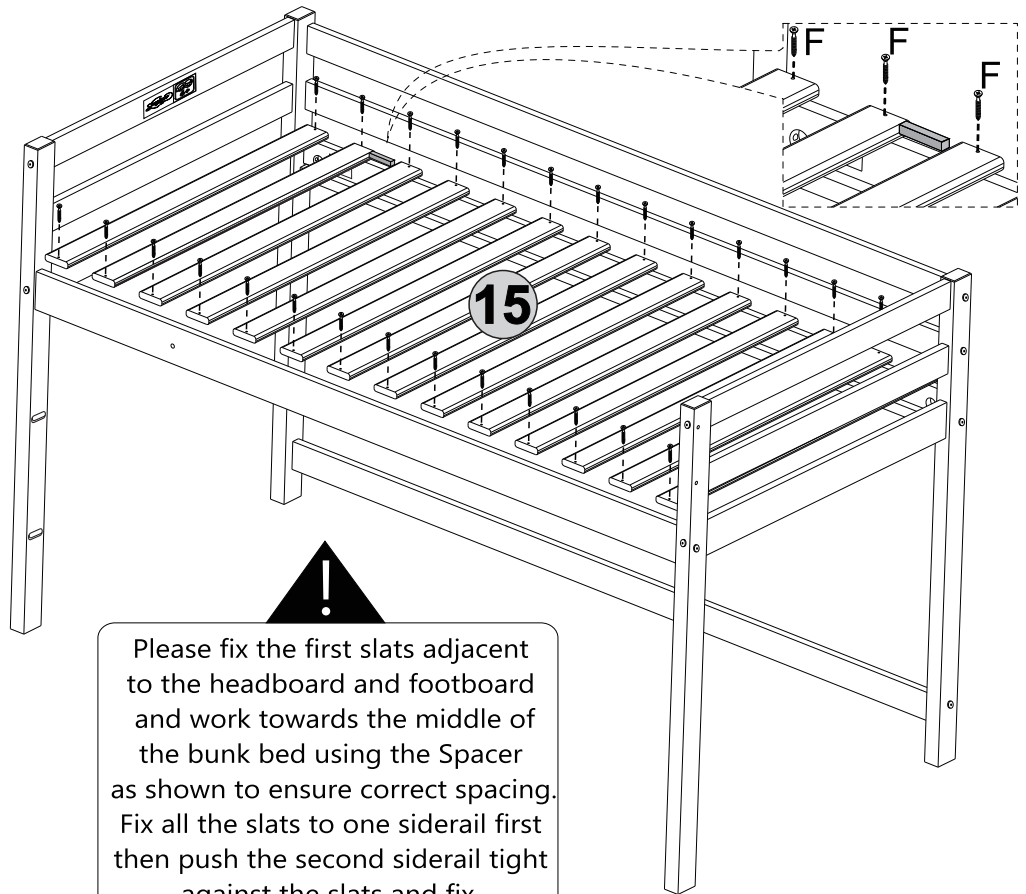
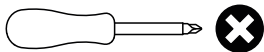

**!**  
Please fix the first slats adjacent to the headboard and footboard and work towards the middle of the bunk bed using the Spacer as shown to ensure correct spacing. Fix all the slats to one siderail first then push the second siderail tight against the slats and fix.

# STEP 10

## PARTS REQUIRED

11 - LADDER STEPS (NATURAL) x2

14 - LADDER UPRIGHT (BLACK) x1

## HARDWARE REQUIRED

E  02  
7 x 40mm

K  01

## TOOLS REQUIRED

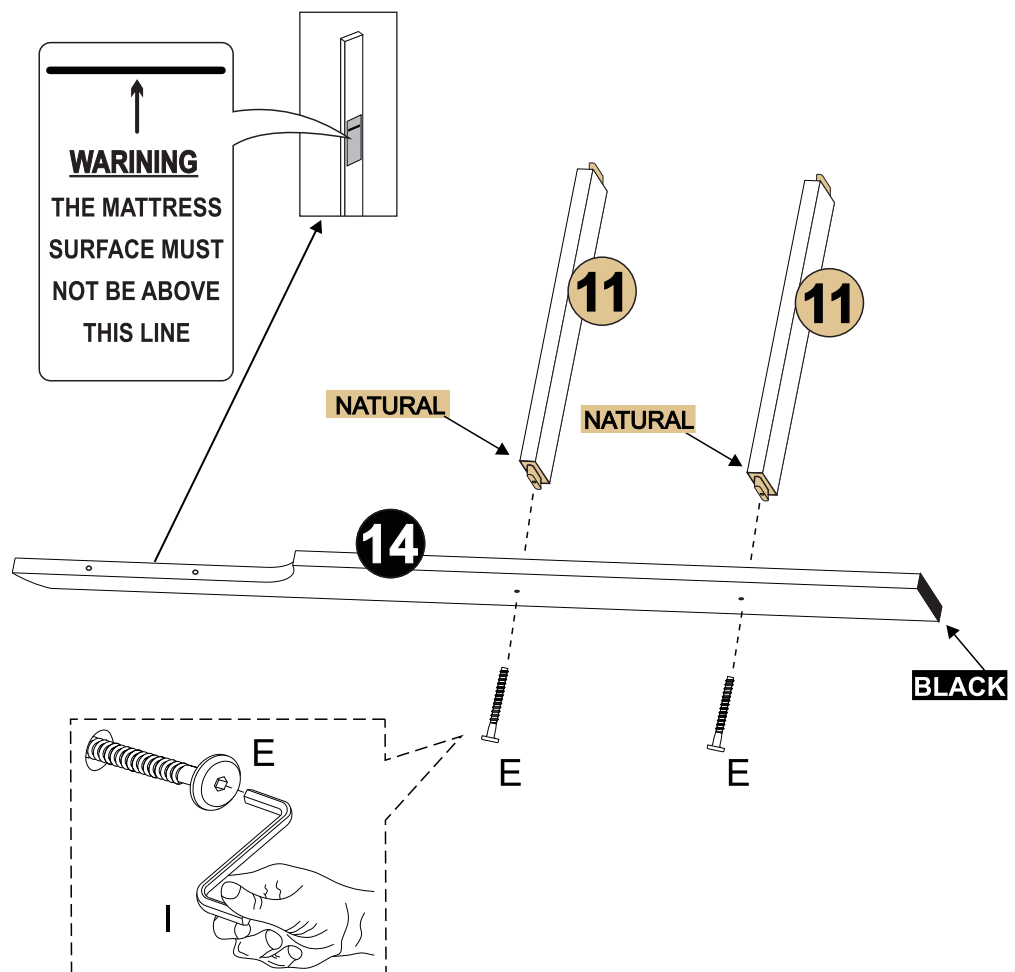
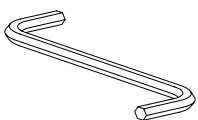



# STEP 11

**PARTS REQUIRED**

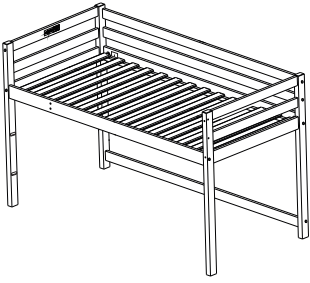

**HARDWARE REQUIRED**

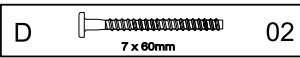

**TOOLS REQUIRED**

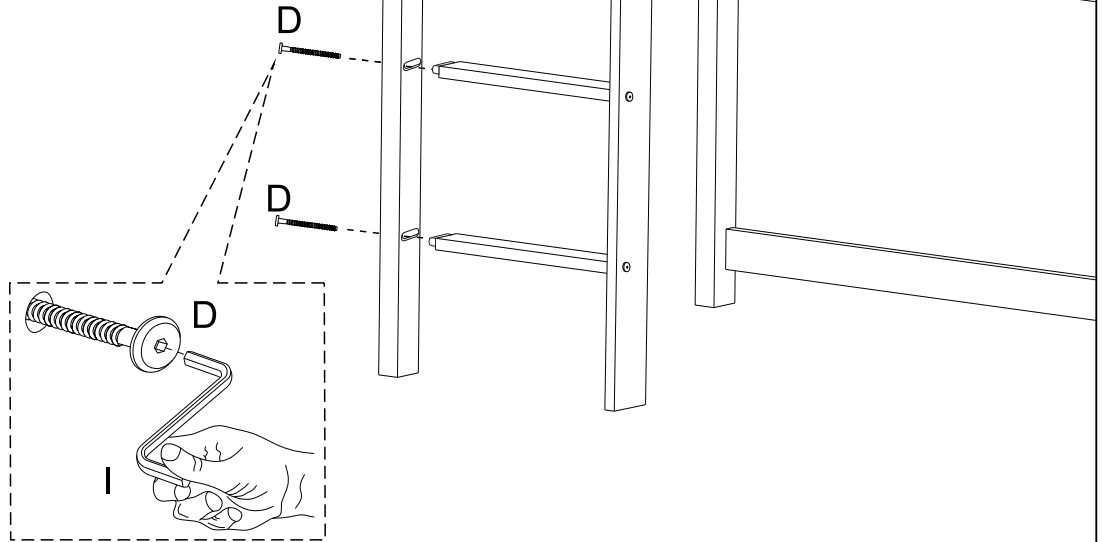
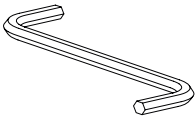
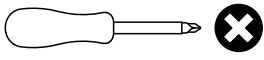

# STEP 12

**PARTS REQUIRED**

12- SHORT SAFETY RAIL (BLUE) x2

**HARDWARE REQUIRED**

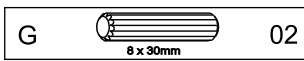

**TOOLS REQUIRED**

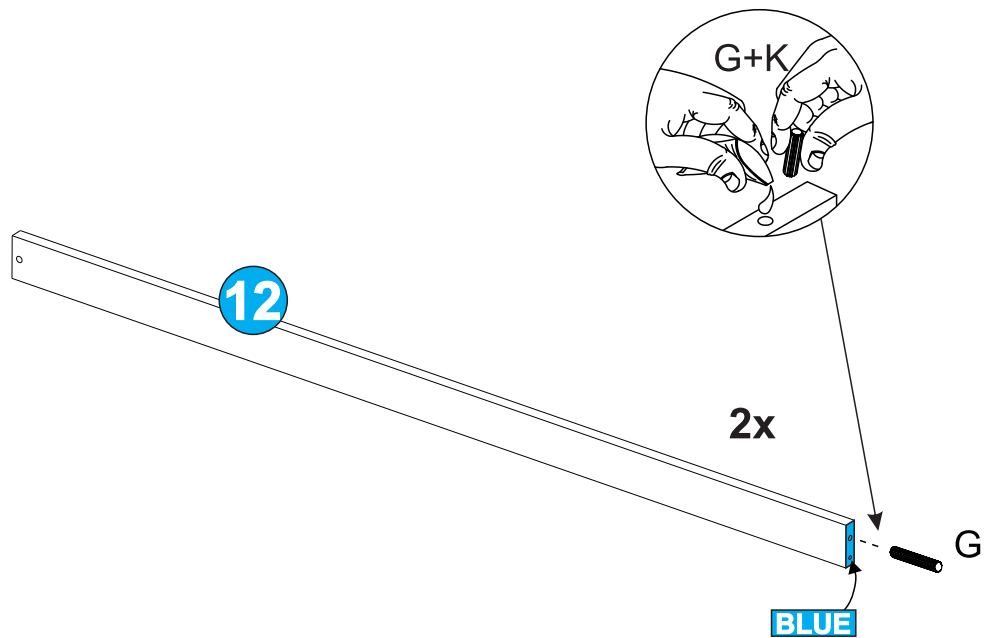

# STEP 13

## PARTS REQUIRED

12- SHORT SAFETY RAIL (BLUE) x2

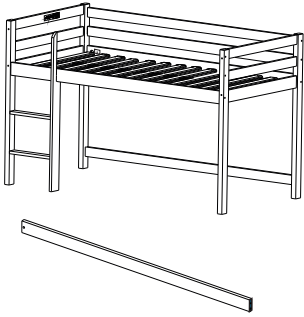

## HARDWARE REQUIRED

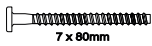
C  02  
7 x 60mm

E  03  
7 x 40mm

## TOOLS REQUIRED

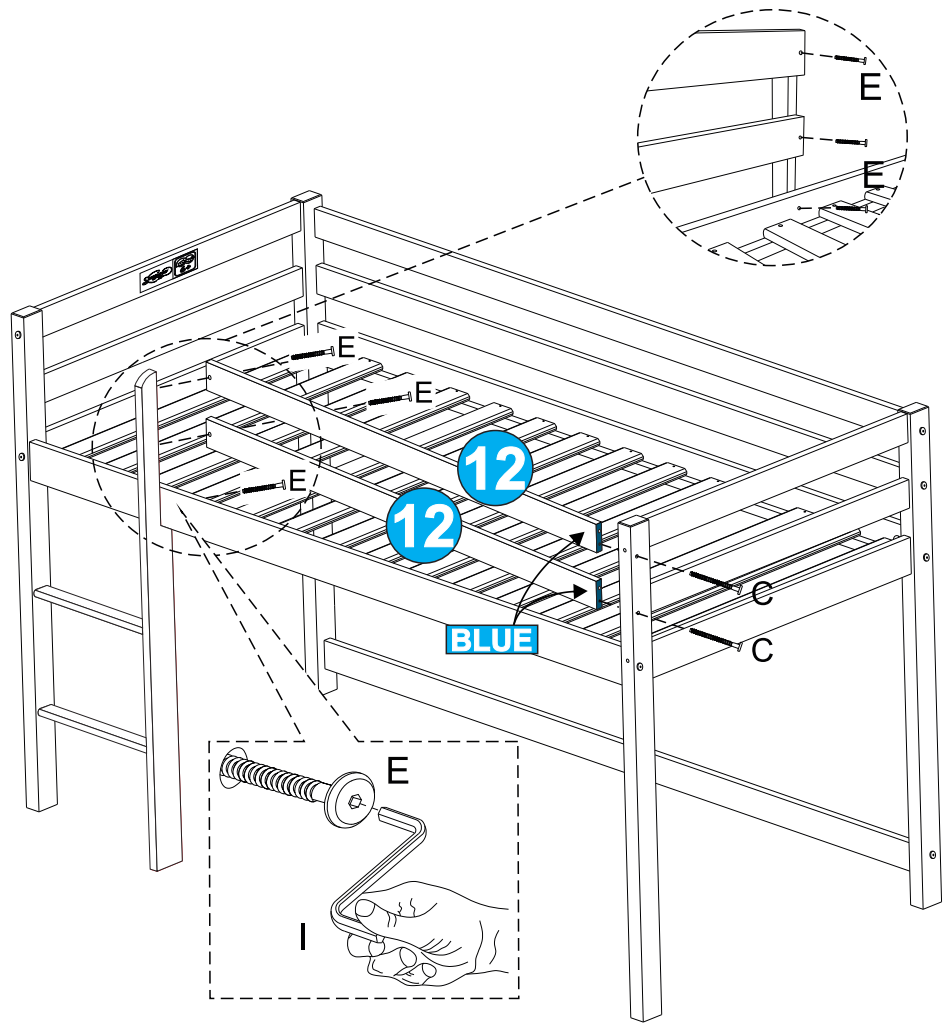
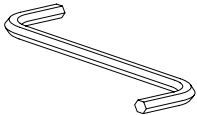

# STEP 14

13- SUPPORT BRACE(WITH HOLES) (WHITE) x2

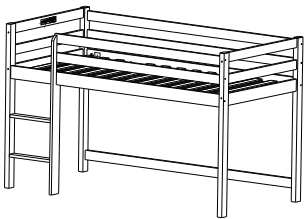

## HARDWARE REQUIRED

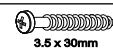
H  06  
3.5 x 30mm

## TOOLS REQUIRED

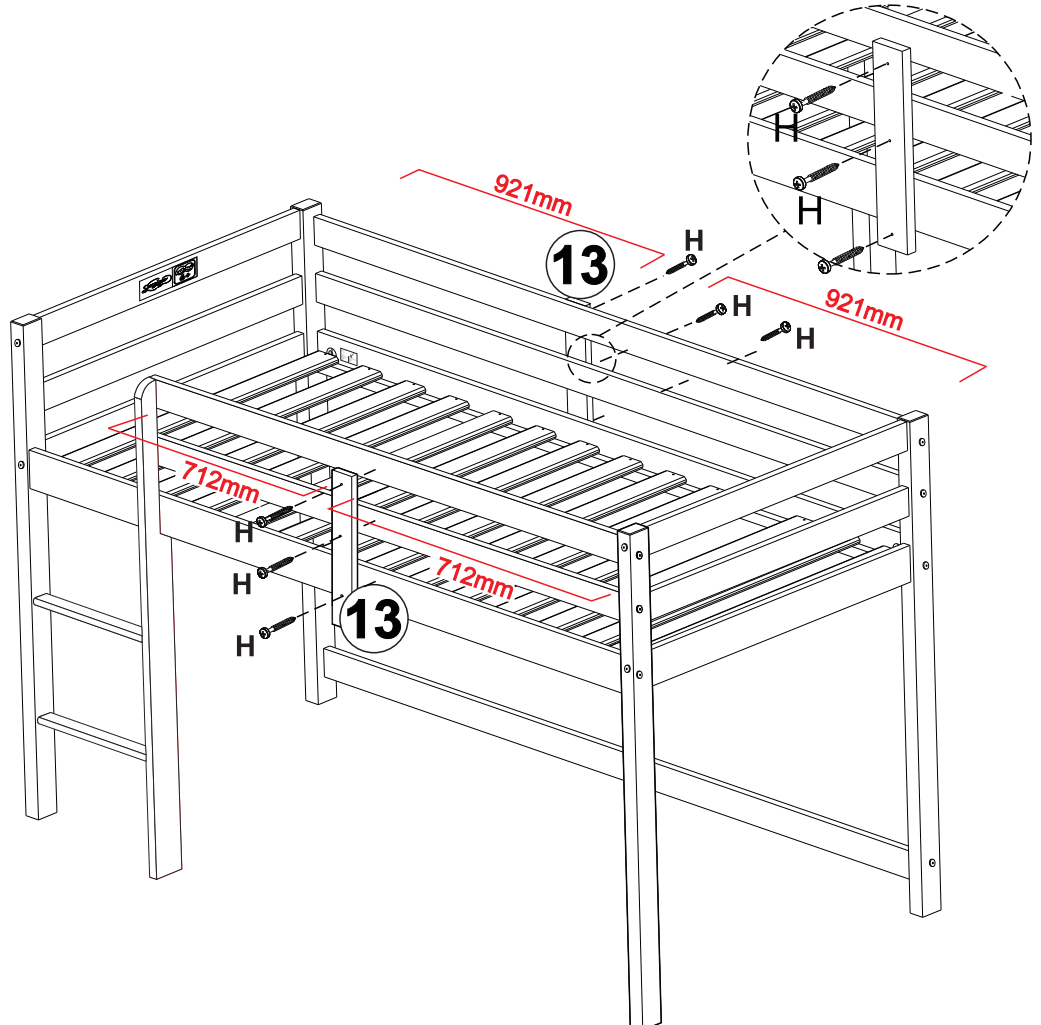
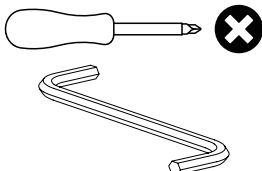

INFORMATIONS IMPORTANTES (FRENCH)	INFORMACIÓN IMPORTANTE (SPANISH)
<p style="text-align: center;"><b>IMPORTANTE POUR USAGE DOMESTIQUE UNIQUEMENT VEUILLEZ LIRE AVANT DE CONTINUER</b></p> <p>AVERTISSEMENT Les lits hauts et le lit supérieur des lits superposés ne conviennent pas aux enfants de moins de six ans en raison du risque de blessure en cas de chute.</p> <p>AVERTISSEMENT Les lits superposés et les lits hauts peuvent présenter un risque sérieux de blessure par strangulation s'ils ne sont pas utilisés correctement. Ne jamais attacher ou suspendre des objets à une partie du lit superposé qui ne sont pas conçus pour être utilisés avec le lit, par exemple, mais sans s'y limiter ; des cordes, des ficelles, des crochets, des ceintures et des sacs.</p> <p>AVERTISSEMENT Les enfants peuvent se retrouver coincés entre le lit et le mur, une pente de toit, le plafond, des meubles adjacents (par exemple des placards) et autres. Pour éviter tout risque de blessure grave, la distance entre la barrière de sécurité supérieure et la structure adjacente ne doit pas dépasser 75 mm ou être supérieure à 230 mm.</p> <p>AVERTISSEMENT N'utilisez pas le lit superposé/lit haut si une pièce structurelle est cassée ou manquante.</p> <p>La taille de matelas recommandée pour ce lit superposé est de 1900 mm x 915 mm x 150 mm.</p> <p>La hauteur maximale du matelas est de 160 mm.</p> <p>La hauteur maximale du matelas est clairement indiquée sur le lit superposé et <b>NE DOIT PAS ÊTRE DÉPASSÉE</b>.</p> <p>En fonction de l'utilisation que ce produit reçoit, il peut être nécessaire de resserrer les fixations de temps en temps, ce qui est tout à fait normal pour les meubles en kit. <b>NE SERREZ PAS TROP LES FIXATIONS.</b></p> <p>N'utilisez en aucun cas un outil électrique pour assembler ce produit. Deux personnes sont nécessaires pour assembler ce lit superposé. Assemblez-le aussi près que possible de sa position finale. Assemblez-le sur une surface douce et propre.</p> <p>Pour le nettoyage, vous pouvez utiliser un chiffon humide (pas mouillé). La pièce dans laquelle le lit est placé doit être ventilée pour éviter la moisissure dans et autour du lit.</p> <p>Ce lit superposé est fabriqué conformément à la norme BS EN 747:2012+A1:2015</p>	<p style="text-align: center;"><b>IMPORTANTE SOLO PARA USO DOMÉSTICO LEER ANTES DE CONTINUAR</b></p> <p>ADVERTENCIA Las camas altas y la cama superior de las literas no son adecuadas para niños menores de seis años debido al riesgo de lesiones por caídas.</p> <p>ADVERTENCIA Las literas y las camas altas pueden presentar un riesgo grave de lesiones por estrangulamiento si no se utilizan correctamente. Nunca fije ni cuelgue elementos en ninguna parte de la litera que no estén diseñados para usarse con la cama, por ejemplo, pero no limitado a; cuerdas, cordones, ganchos, cinturones y bolsos.</p> <p>ADVERTENCIA Los niños pueden quedar atrapados entre la cama y la pared, un techo inclinado, el techo, muebles adyacentes (por ejemplo, armarios) y similares. Para evitar el riesgo de lesiones graves, la distancia entre la barrera de seguridad superior y la estructura adyacente no debe superar los 75 mm ni los 230 mm.</p> <p>ADVERTENCIA No utilice la litera/cama alta si alguna pieza estructural está rota o falta.</p> <p>El tamaño de colchón recomendado para esta litera es de 1900 mm x 915 mm x 150 mm.</p> <p>La altura máxima del colchón es de 160 mm.</p> <p>La altura máxima del colchón está claramente marcada en la litera y <b>NO SE DEBE SOBREPASAR</b>.</p> <p>Dependiendo de la cantidad de uso que reciba este producto, puede ser necesario apretar las fijaciones de vez en cuando, esto es completamente normal en muebles modulares. <b>NO APRIETE DEMASIADO LAS FIJACIONES.</b></p> <p>No utilice bajo ningún concepto una herramienta eléctrica para ensamblar este producto.</p> <p>Se necesitan dos personas para ensamblar esta litera.</p> <p>Ensamble lo más cerca posible de su posición final.</p> <p>Ensamble sobre una superficie suave y limpia.</p> <p>Para la limpieza, puede usar un paño húmedo (no mojado).</p> <p>La habitación en la que se coloca la cama debe estar ventilada para evitar la formación de moho dentro y alrededor de la cama.</p> <p>Esta litera está fabricada de acuerdo con la norma BS EN 747:2012+A1:2015.</p>
WICHTIGE INFORMATIONEN (GERMAN)	INFORMAZIONI IMPORTANTI (ITALIAN)
<p style="text-align: center;"><b>WICHTIGNUR FÜR DEN HAUSHALTSGEBRAUCH BITTE LESEN SIE, BEVOR SIE FORTFAHREN</b></p> <p>WARNUNG Hochbetten und das obere Bett von Etagenbetten sind aufgrund der Verletzungsgefahr durch Stürze nicht für Kinder unter sechs Jahren geeignet.</p> <p>WARNUNG Etagenbetten und Hochbetten können bei unsachgemäßer Verwendung eine ernsthafte Verletzungsgefahr durch Strangulation darstellen. Befestigen oder hängen Sie niemals Gegenstände an Teilen des Etagenbetts auf, die nicht für die Verwendung mit dem Bett vorgesehen sind, beispielsweise, aber nicht beschränkt auf, Seile, Schnüre, Haken, Gürtel und Taschen.</p> <p>WARNUNG Kinder können zwischen dem Bett und der Wand, einer Dachschräge, der Decke, angrenzenden Möbelstücken (z. B. Schränken) und dergleichen eingeklemmt werden. Um das Risiko schwerer Verletzungen zu vermeiden, darf der Abstand zwischen der oberen Sicherheitsbarriere und der angrenzenden Struktur 75 mm nicht überschreiten oder muss mehr als 230 mm betragen.</p> <p>WARNUNG Verwenden Sie das Etagenbett/Hochbett nicht, wenn ein Strukturteil gebrochen ist oder fehlt.</p> <p>Die empfohlene Matratzengröße für dieses Etagenbett beträgt 1900 mm x 915 mm x 150 mm.</p> <p>Die maximale Matratzenhöhe beträgt 160 mm.</p> <p>Die maximale Matratzenhöhe ist auf dem Etagenbett deutlich gekennzeichnet und <b>DARF NICHT ÜBERSCHRITTEN WERDEN</b>.</p> <p>Je nachdem, wie häufig dieses Produkt verwendet wird, kann es von Zeit zu Zeit erforderlich sein, die Befestigungen festzuziehen. Dies ist bei Möbeln aus dem Bausatz völlig normal. <b>ZIEHEN SIE DIE BEFESTIGUNGEN NICHT ZU FEST.</b></p> <p>Verwenden Sie zum Zusammenbau dieses Produkts unter keinen Umständen ein Elektrowerkzeug.</p> <p>Zum Zusammenbau dieses Etagenbetts sind zwei Personen erforderlich. So nah wie möglich an der endgültigen Position zusammenbauen.</p> <p>Auf einer weichen, sauberen Oberfläche zusammenbauen.</p> <p>Zum Reinigen können Sie ein feuchtes Tuch (nicht nass) verwenden.</p> <p>Der Raum, in dem das Bett steht, sollte belüftet sein, um Schimmel im und um das Bett herum zu verhindern. Dieses Etagenbett wird gemäß BS EN 747:2012+A1:2015 hergestellt.</p>	<p style="text-align: center;"><b>IMPORTANTE, SOLO PER USO DOMESTICO SI PREGA DI LEGGERE PRIMA DI CONTINUARE OLTRE</b></p> <p>ATTENZIONE I letti alti e il letto superiore dei letti a castello non sono adatti ai bambini di età inferiore ai sei anni a causa del rischio di lesioni da caduta.</p> <p>ATTENZIONE I letti a castello e i letti alti possono presentare un grave rischio di lesioni da strangolamento se non utilizzati correttamente. Non attaccare o appendere mai oggetti a nessuna parte del letto a castello che non siano progettati per essere utilizzati con il letto, ad esempio, ma non limitati a; corde, spaghi, ganci, cinture e borse.</p> <p>ATTENZIONE I bambini possono rimanere intrappolati tra il letto e il muro, una pendenza del tetto, il soffitto, mobili adiacenti (ad esempio armadi) e simili. Per evitare il rischio di lesioni gravi, la distanza tra la barriera di sicurezza superiore e la struttura adiacente non deve superare i 75 mm o deve essere superiore a 230 mm.</p> <p>ATTENZIONE Non utilizzare il letto a castello/letto alto se una parte strutturale è rotta o mancante.</p> <p>Le dimensioni del materasso consigliate per questo letto a castello sono 1900 mm x 915 mm x 150 mm.</p> <p>L'altezza massima del materasso è 160 mm. L'altezza massima del materasso è chiaramente indicata sul letto a castello e <b>NON DEVE ESSERE SUPERATA</b>.</p> <p>A seconda della quantità di utilizzo di questo prodotto, potrebbe essere necessario stringere i fissaggi di tanto in tanto, il che è del tutto normale per i mobili in kit. <b>NON STRINGERE ECCESSIVAMENTE I FISSAGGI.</b></p> <p>Non utilizzare per nessun motivo un elettroutensile per montare questo prodotto.</p> <p>Per montare questo letto a castello sono necessarie due persone.</p> <p>Montare il più vicino possibile alla sua posizione finale.</p> <p>Montare su una superficie morbida e pulita.</p> <p>Per la pulizia, è possibile utilizzare un panno umido (non bagnato).</p> <p>La stanza in cui è posizionato il letto deve essere ventilata per evitare la formazione di muffa dentro e intorno al letto.</p> <p>Questo letto a castello è prodotto in conformità alla norma BS EN 747:2012+A1:2015</p>