

GREY

NAPLES COFFEE TABLE

ASSEMBLY INSTRUCTIONS



IMPORTANT FOR DOMESTIC USE ONLY

PLEASE READ BEFORE YOU CONTINUE FURTHER

CARE AND MAINTENANCE

After unpacking this product please keep the original packaging in case it needs to be returned for any reason.

- Please ensure all fittings and parts are present before commencing with assembly.
- Never drag or push products as this could cause damage to the joints making it inferior.
- We strongly recommend that you keep children away from your work area.
- We recommend that you lay a blanket or sheet on the floor to avoid damage to both your floor and the product.
- Assemble this product as close to its final position as possible.
- Do not place this product next to a radiator or in direct sunlight.
- Do not drag or push items across your high gloss furniture as this may cause the surface to scratch
- Wood is a natural product and may expand if subjected to damp and may shrink or crack if subjected to heat. Therefore it is recommended that room temperature is maintained, with no sudden temperature fluctuations.
- Make sure any spillage is wiped off immediately.
- Do not place hot or chilled items directly on to the surface, use a place mat or marking will occur.
- For general cleaning use a soft cotton or micro fibre cloth, and do not use detergents of any kind.
- From time to time it may be necessary to tighten fittings, regular inspections should be carried out.
- Do not place on a wet or damp floor as staining may occur to your floor.

TOOLS REQUIRED

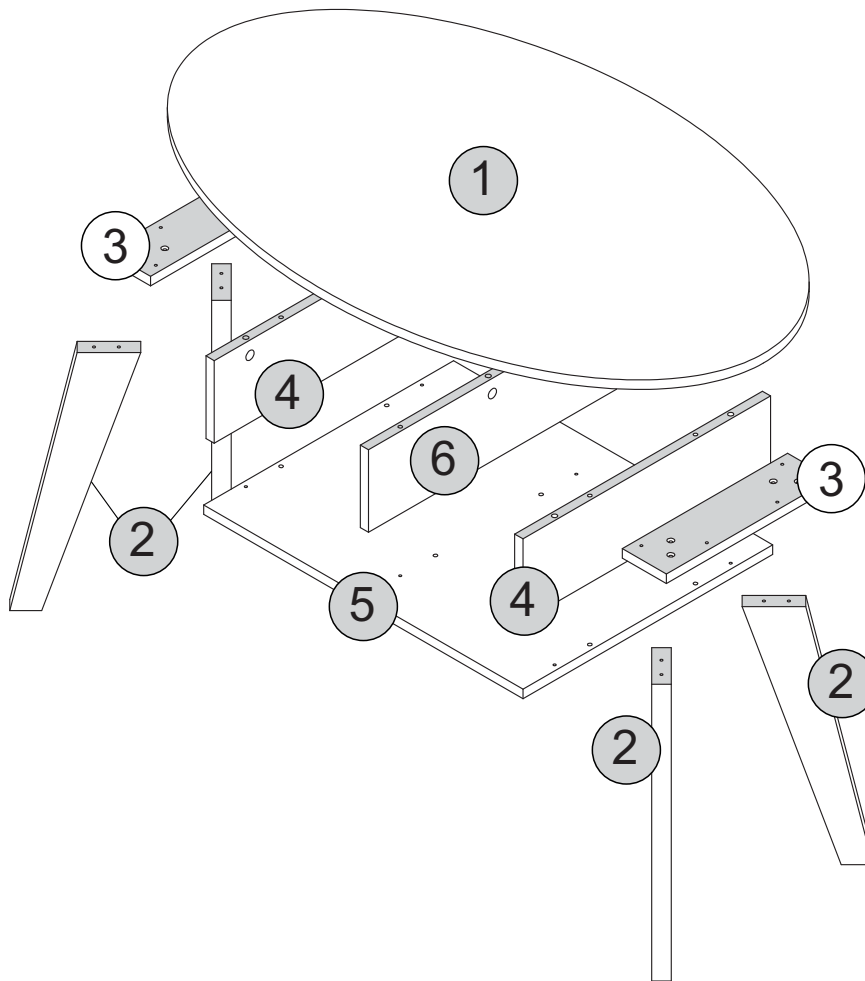
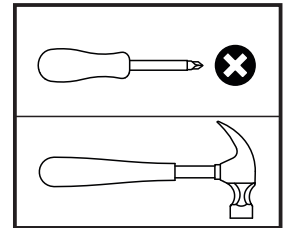





PARTS LIST

Please Note:

The below parts have all been stamped with the part number to help identify them during assembly.

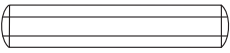
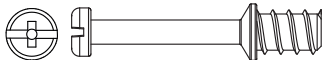
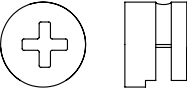
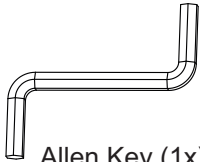
| Part Number | Part Code | Part Description | Quantity | Carton |
|-------------|---------------------|------------------|----------|--------|
| 1 | S300-301-061-AY1-01 | Top | 1 | 1/1 |
| 2 | S300-301-061-AY1-02 | Leg | 4 | 1/1 |
| 3 | S300-301-061-AY1-03 | Leg Support | 2 | 1/1 |
| 4 | S300-301-061-AY1-04 | Side Panel | 2 | 1/1 |
| 5 | S300-301-061-AY1-05 | Shelf | 1 | 1/1 |
| 6 | S300-301-061-AY1-06 | Division Panel | 1 | 1/1 |

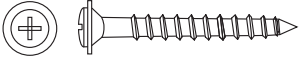
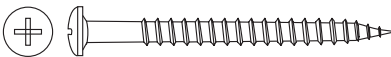
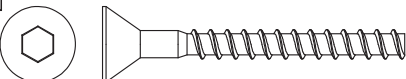
FITTINGS LIST

| | | | |
|---|---|---|---|
| <p>A</p>  <p>2/+ Dowel Ø6,0 x 30mm (12x)</p> | <p>B</p>  <p>1/+ Cam Bolt (5x)</p> | <p>C</p>  <p>1/+ Cam Nut (5x)</p> | <p>D</p>  <p>Allen Key (1x)</p> |
| <p>E</p>  <p>1/+ Plastic Foot 5X10mm (4x)</p> | <p>F</p>  <p>1/+ Flan Head Screw Ø4 x 25mm (8x)</p> | <p>G</p>  <p>1/+ Pan Head Screw Ø3,5 x 40mm (6x)</p> | |
| <p>H</p>  <p>1/+ Flat Head Screw Ø5 x 40mm (8x)</p> | <p>I</p>  <p>Glue (1x)</p> | <p>J</p>  <p>1/+ Hole Plugs (5x)</p> | |

TIPS FOR FITTINGS CAM-LOCKS

WHEN FITTING CAM NUT. ENSURE STARTING POSITION IS CORRECT BEFORE YOU INSERT CONNECTING CAM BOLT TURN CLOCKWISE UNTIL SECURE

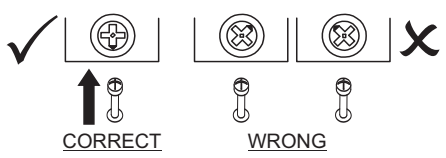

↑
↑
↑

CORRECT
WRONG

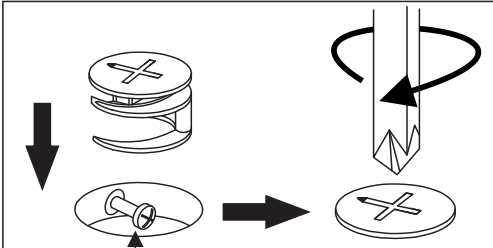

Cam bolt head needs to be in centre

CAMBOLT

Tighten until shoulder in flush with panel. Do not overtighten or undertighten (see example below)

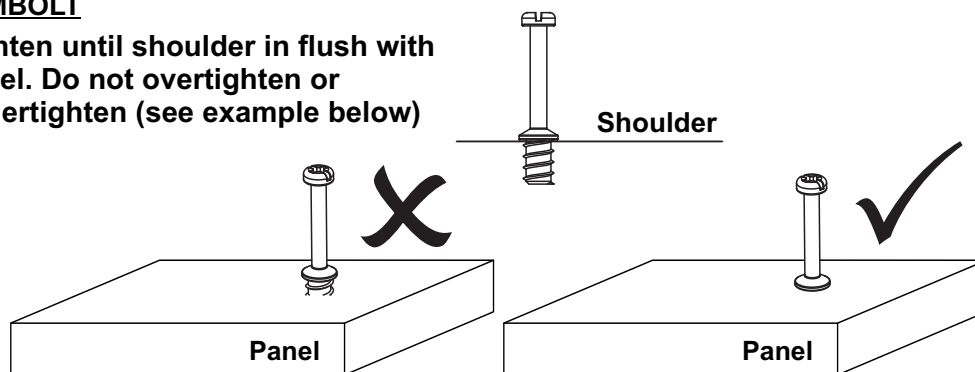

STEP 1

PARTS REQUIRED

1 - TOP x1

HARDWARE REQUIRED

B  05

TOOLS REQUIRED

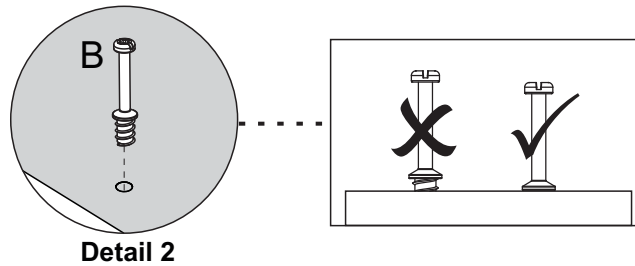
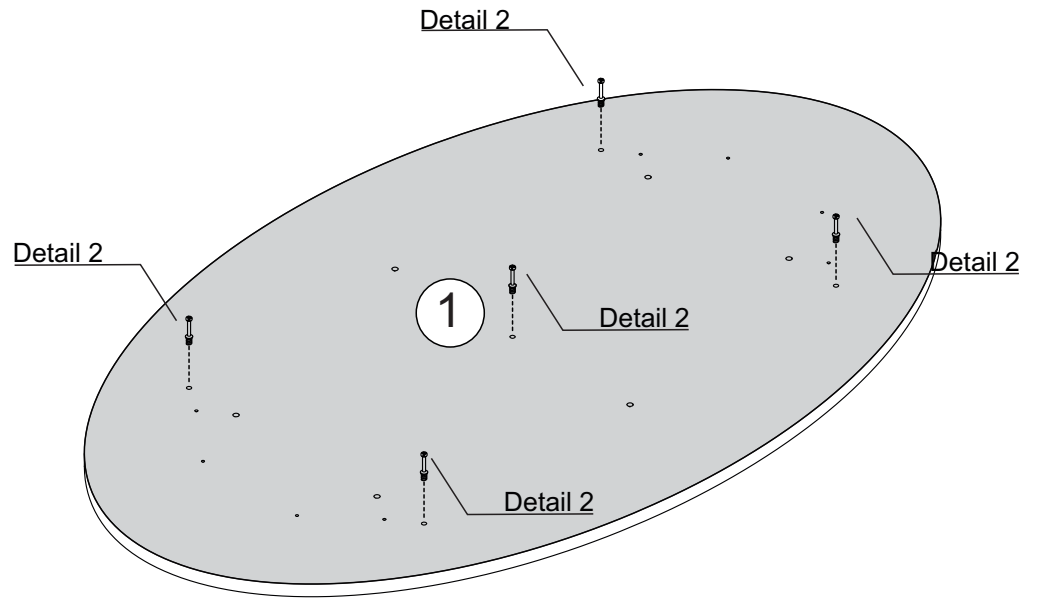
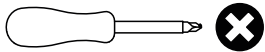

STEP 2

PARTS REQUIRED

4 - SIDE PANEL x2

HARDWARE REQUIRED

A  08

I  01

TOOLS REQUIRED

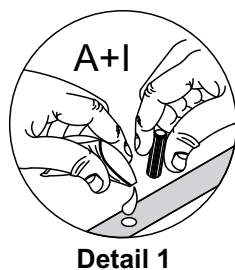
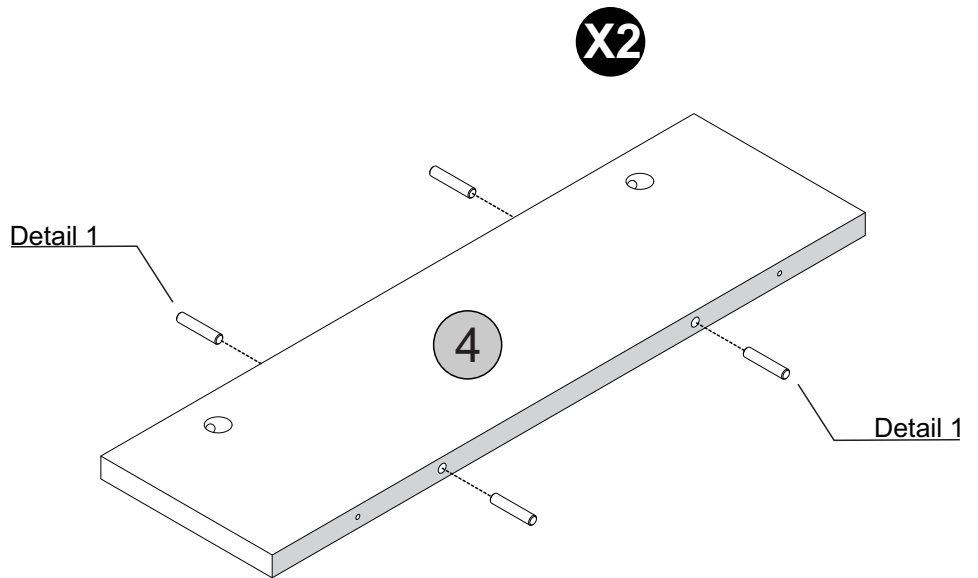
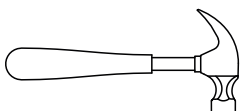

STEP 3

PARTS REQUIRED

6 - DIVISION PANEL x1

HARDWARE REQUIRED

A  04

I  GLUE 01

TOOLS REQUIRED

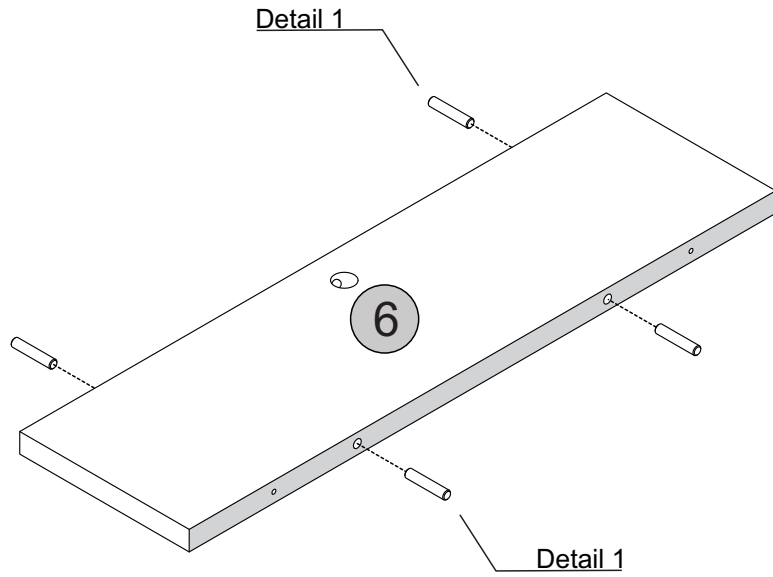
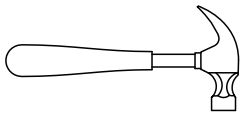

Detail 1

STEP 4

PARTS REQUIRED

2 - LEG x4

HARDWARE REQUIRED

E  04

TOOLS REQUIRED

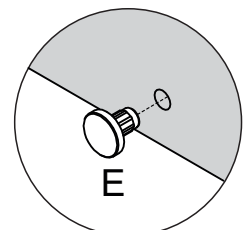
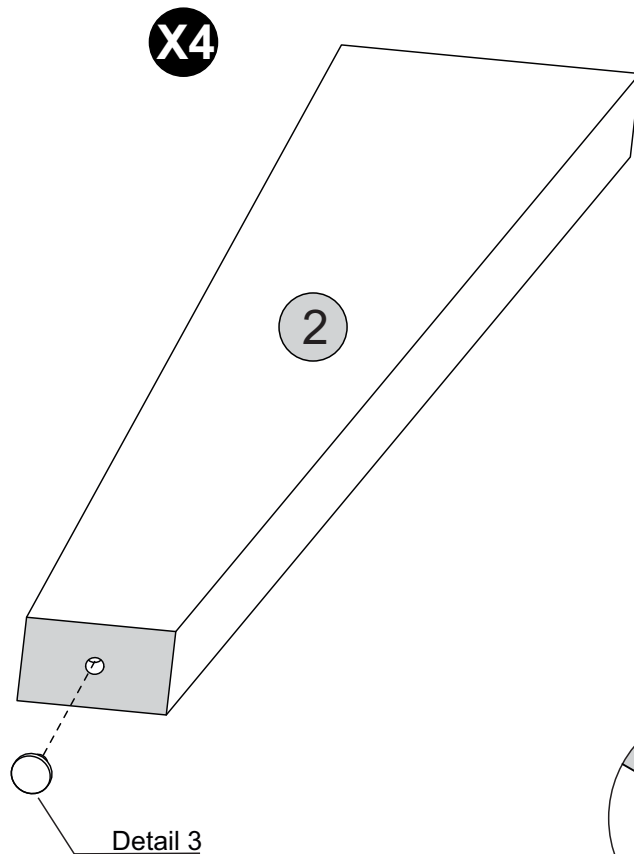
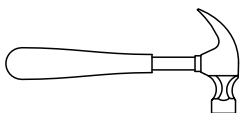

Detail 3

STEP 5

PARTS REQUIRED

2 - LEG x4

3 - LEG SUPPORT x2

HARDWARE REQUIRED

H  08

TOOLS REQUIRED

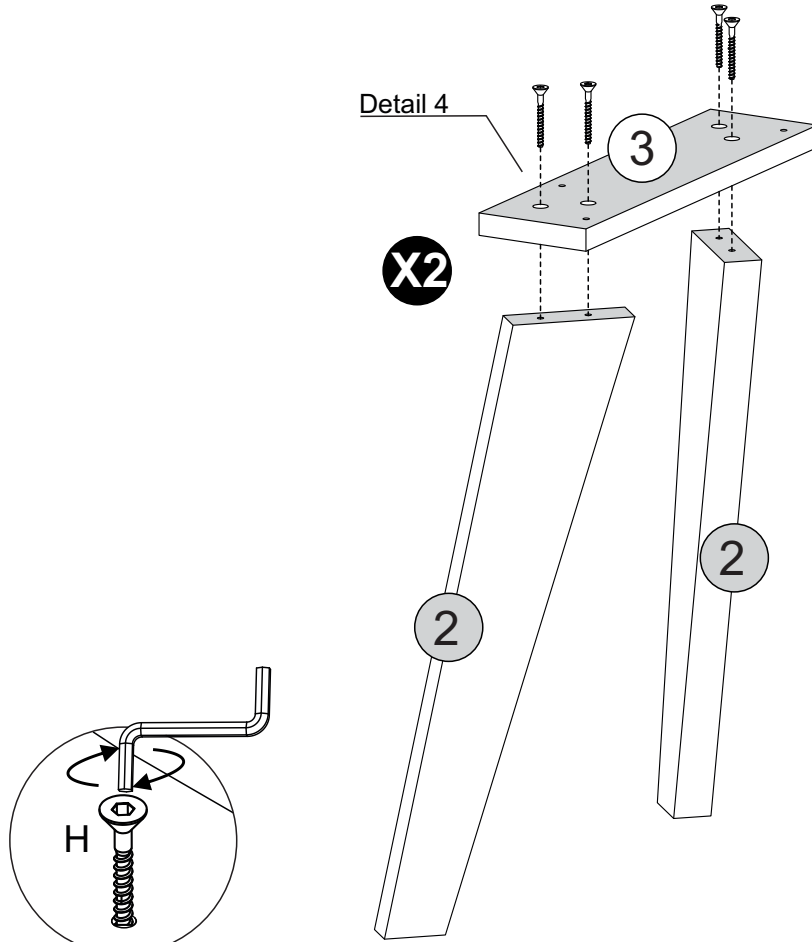
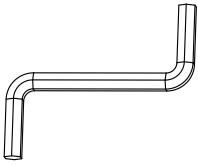

Detail 4

STEP 6

PARTS REQUIRED

1 - TOP x1

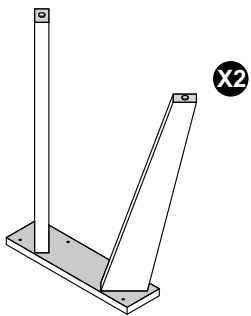

HARDWARE REQUIRED

F  08

TOOLS REQUIRED

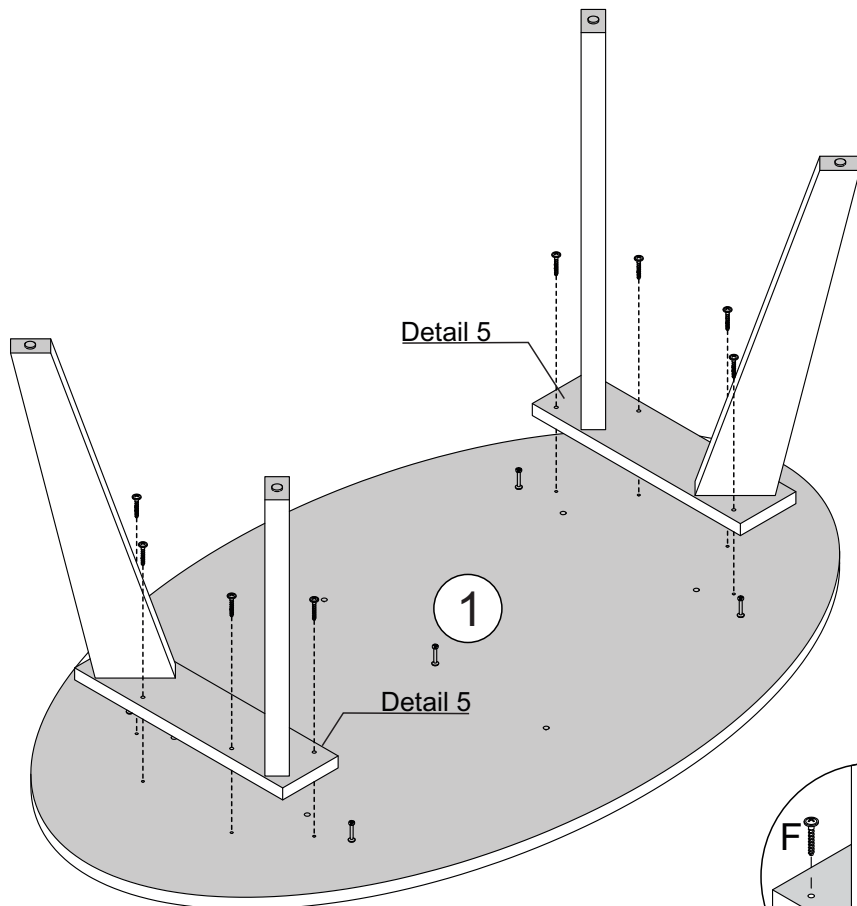
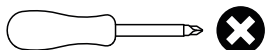

Detail 5

STEP 7

PARTS REQUIRED

4 - SIDE PANEL x2

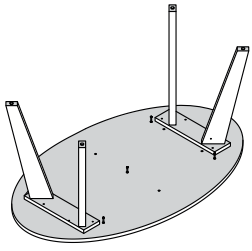

HARDWARE REQUIRED

C   04

I  01

J  04

TOOLS REQUIRED

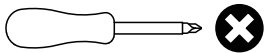

Detail 8

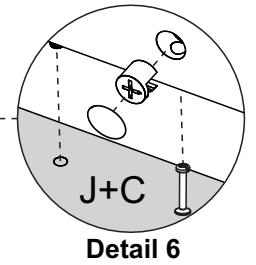
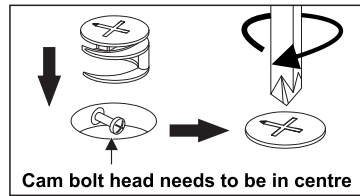
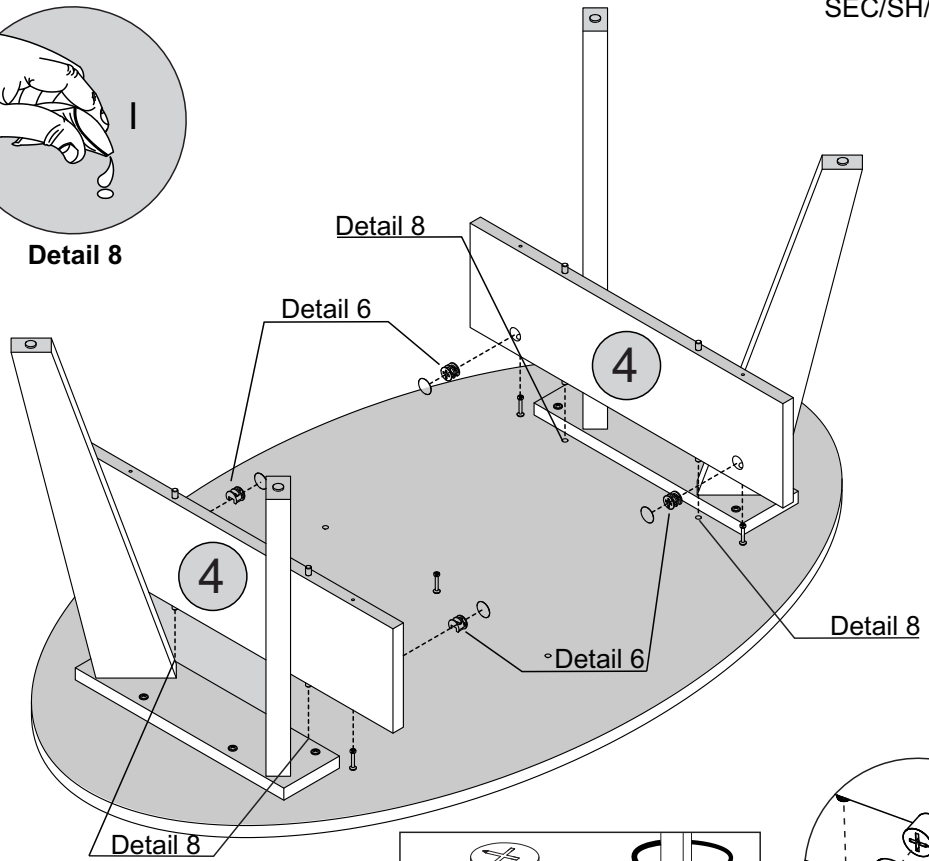



STEP 8

PARTS REQUIRED

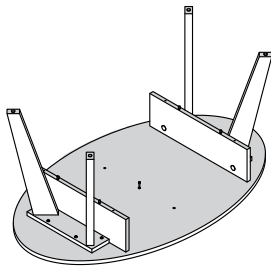
6 - DIVISION PANEL x1



HARDWARE REQUIRED

C   01

I  01

J  01

TOOLS REQUIRED

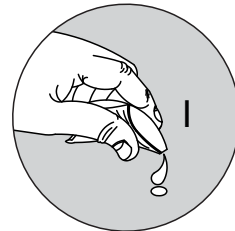
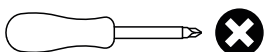

Detail 8

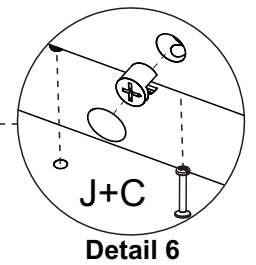
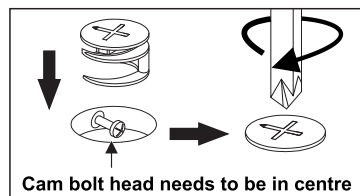
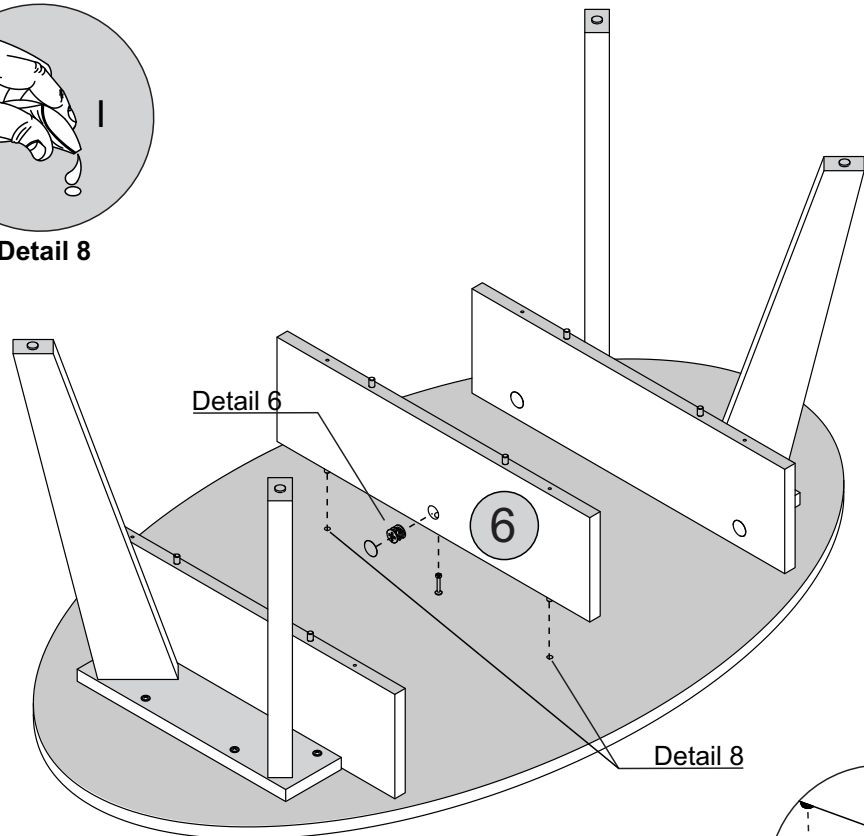

STEP 9

PARTS REQUIRED

5 - SHELF x1

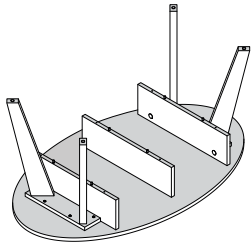

HARDWARE REQUIRED

G 06

I 01

TOOLS REQUIRED

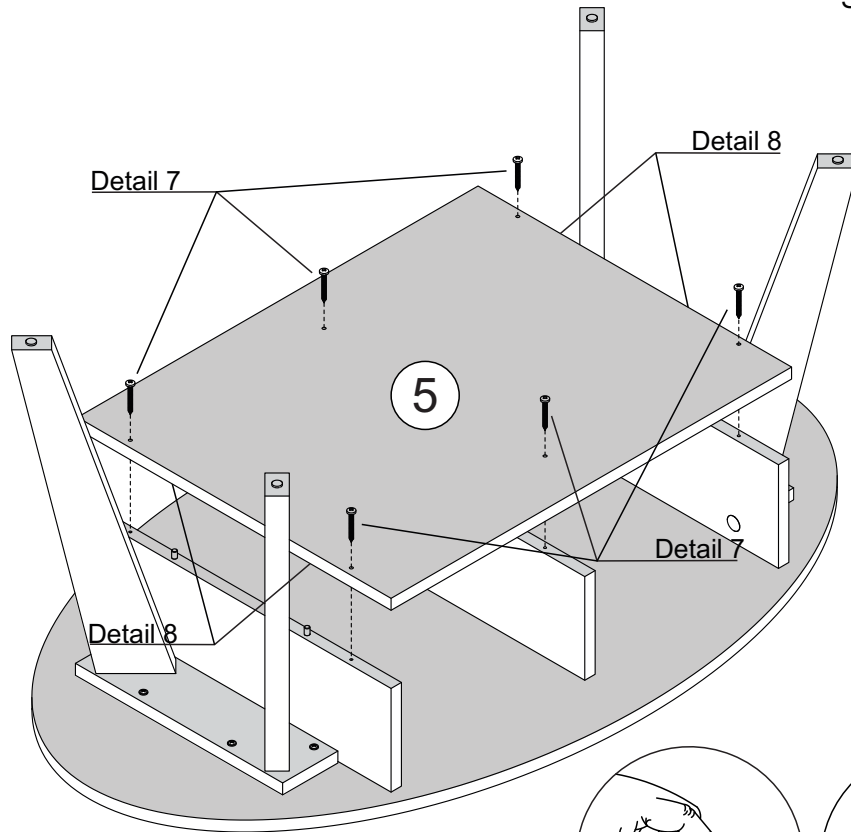
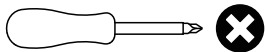

Detail 8

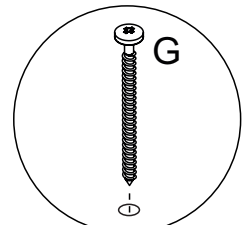

Detail 7

STEP 10

PARTS REQUIRED



HARDWARE REQUIRED

TOOLS REQUIRED

TIP
 If desired, after assembly use an alcohol cleaner to erase the number printed on the parts.

