

# BLACK/PINE EFFECT NAPLES PLANT STAND/SIDE TABLE ASSEMBLY INSTRUCTIONS

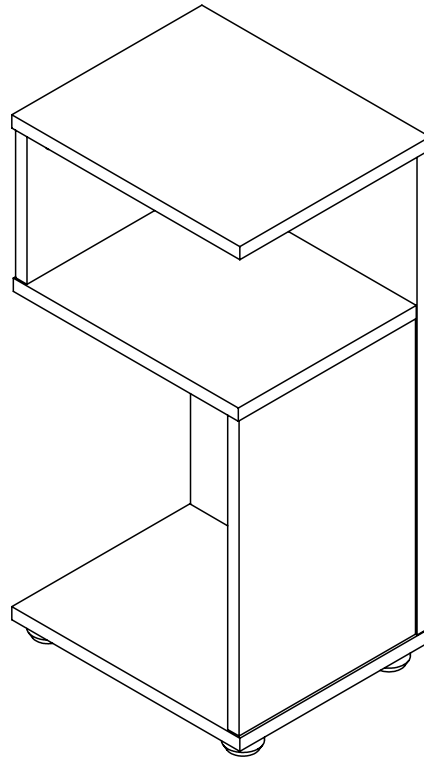
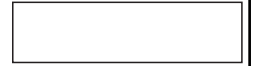

**IMPORTANT  
FOR DOMESTIC USE ONLY  
PLEASE READ BEFORE YOU CONTINUE FURTHER**

## CARE AND MAINTENANCE

After unpacking this product please keep the original packaging in case it needs to be returned for any reason.

- Please ensure all fittings and parts are present before commencing with assembly.
- Never drag or push products as this could cause damage to the joints making it inferior.
- We strongly recommend that you keep children away from your work area.
- We recommend that you lay a blanket or sheet on the floor to avoid damage to both your floor and the product.
- Assemble this product as close to its final position as possible.
- Do not place this product next to a radiator or in direct sunlight.
- Do not drag or push items across your high gloss furniture as this may cause the surface to scratch
- Wood is a natural product and may expand if subjected to damp and may shrink or crack if subjected to heat. Therefore it is recommended that room temperature is maintained, with no sudden temperature fluctuations.
- Make sure any spillage is wiped off immediately.
- Do not place hot or chilled items directly on to the surface, use a place mat or marking will occur.
- For general cleaning use a soft cotton or micro fibre cloth, and do not use detergents of any kind.
- From time to time it may be necessary to tighten fittings, regular inspections should be carried out.
- Do not place on a wet or damp floor as staining may occur to your floor.

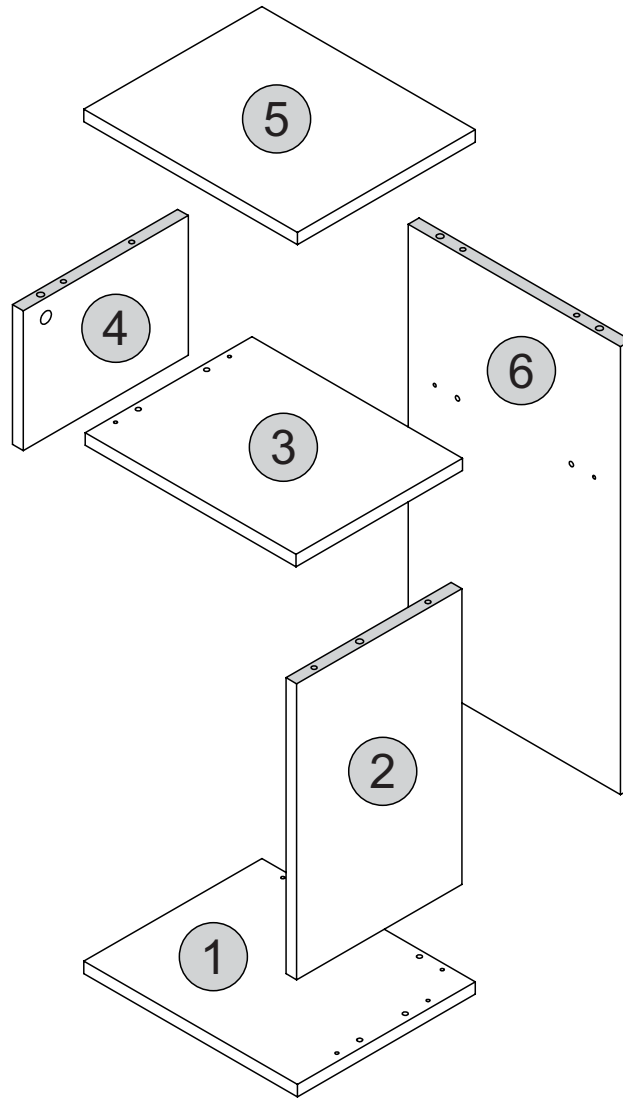

**TOOLS REQUIRED**

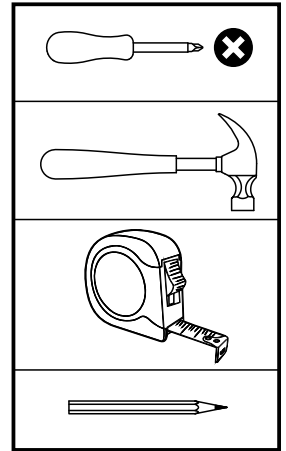





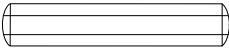

**PARTS LIST**

***Please Note:***  
The below parts have all been stamped with the part number to help identify them during assembly.

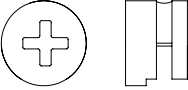
<b>Part Number</b>	<b>Part Code</b>	<b>Part Description</b>	<b>Quantity</b>	<b>Carton</b>
1	S300-302-053-AY1-01	Base Panel	1	1/1
2	S300-302-053-AY1-02	Right Side Panel	1	1/1
3	S300-302-053-AY1-03	Shelf	1	1/1
4	S300-302-053-AY1-04	Left Side Panel	1	1/1
5	S300-302-053-AY1-05	Top Panel	1	1/1
6	S300-302-053-AY1-06	Back Panel	1	1/1

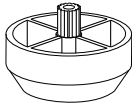
### FITTINGS LIST

<p><b>A</b></p>  <p>2/+ Dowel Ø6,0 x 30mm (14x)</p>	<p><b>B</b></p>  <p>1/+ Cam Bolt (4x)</p>	<p><b>C</b></p>  <p>1/+ Cam Nut (4x)</p>	<p><b>D</b></p>  <p>1/+ PanHead Screw Ø3,5 x 40mm (8x)</p>
<p><b>E</b></p>  <p>Plastic Foot 40x18mm (4x)</p>	<p><b>F</b></p>  <p>1/+ Hole Plugs (4x)</p>	<p><b>G</b></p>  <p>Glue (1x)</p>	

### TIPS FOR FITTINGS CAM-LOCKS

WHEN FITTING CAM NUT. ENSURE STARTING POSITION IS CORRECT BEFORE YOU INSERT CONNECTING CAM BOLT TURN CLOCKWISE UNTIL SECURE

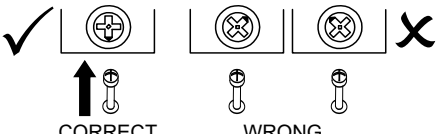

**CORRECT**      **WRONG**

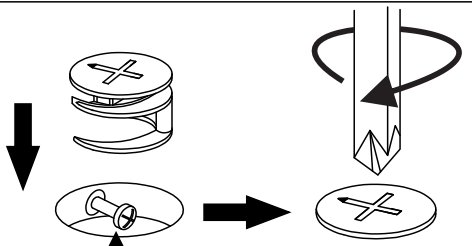

Cam bolt head needs to be in centre

#### CAMBOLT

Tighten until shoulder in flush with panel. Do not overtighten or undertighten (see example below)

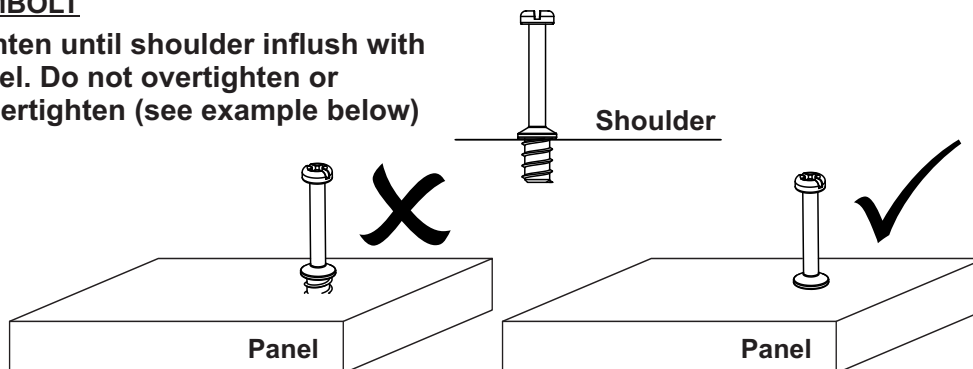

Shoulder

Panel

Panel

# STEP 1

**PARTS REQUIRED**

1 - BASE PANEL x1

**HARDWARE REQUIRED**

E  04

**TOOLS REQUIRED**

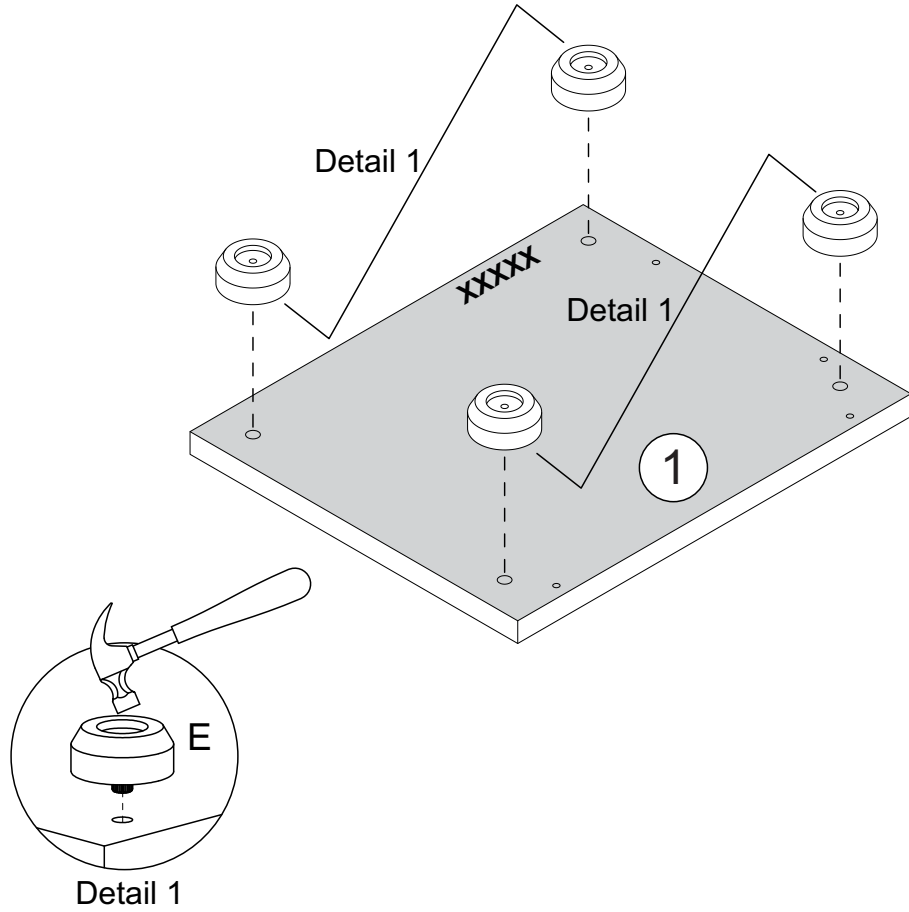
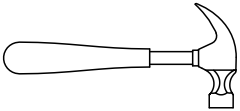

# STEP 2

**PARTS REQUIRED**

2 - RIGHT SIDE PANEL x1

**HARDWARE REQUIRED**

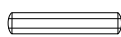
A  04

G  01

**TOOLS REQUIRED**

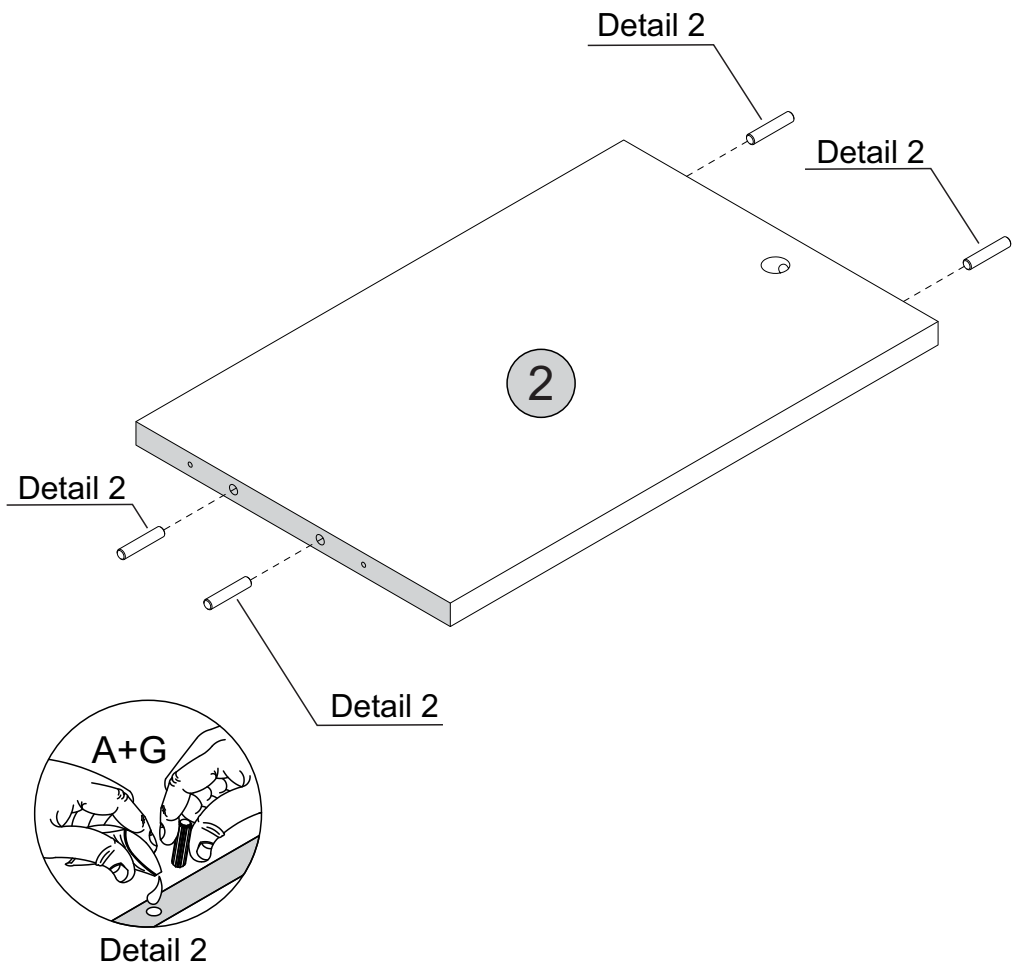
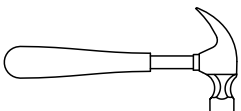

# STEP 3

**PARTS REQUIRED**

5 - TOP PANEL x1

**HARDWARE REQUIRED**

B  03

**TOOLS REQUIRED**

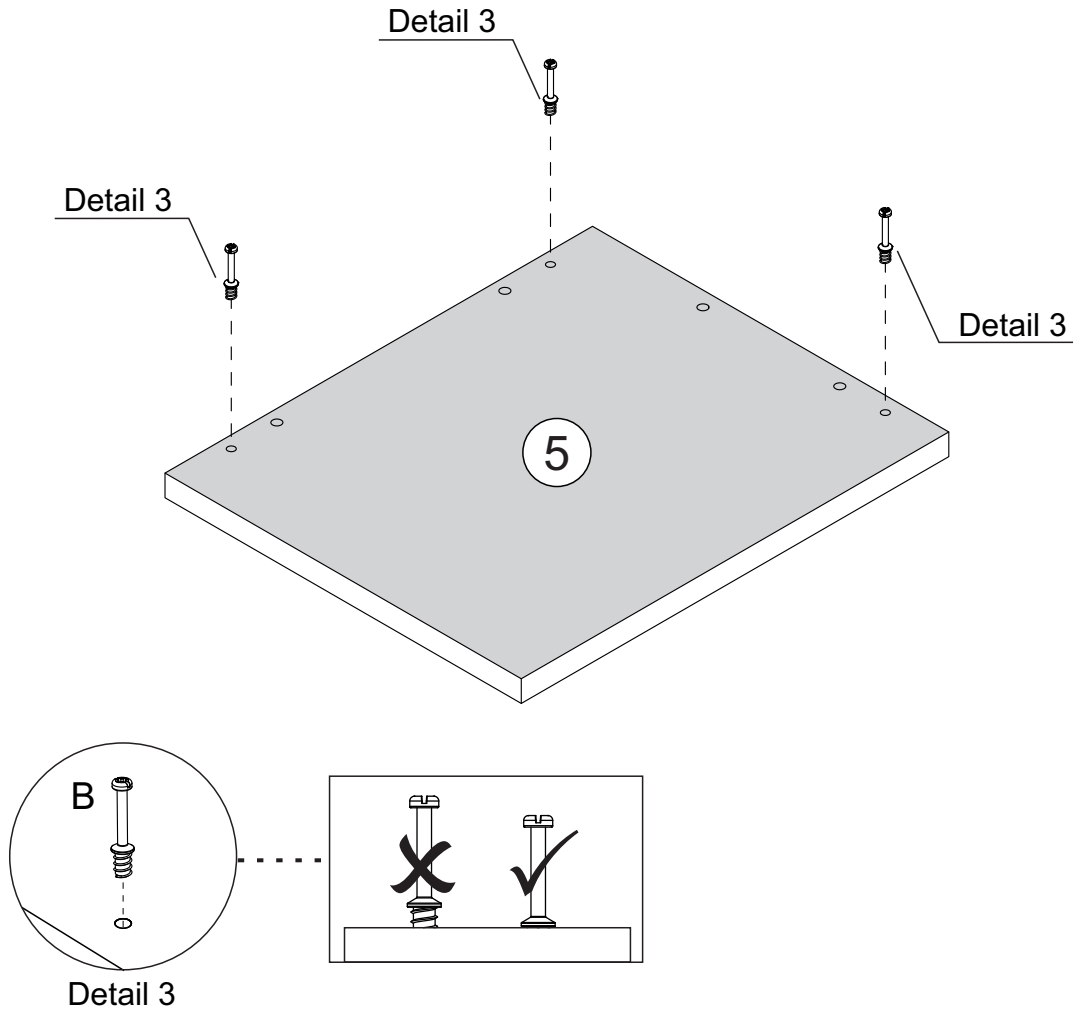
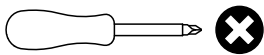

# STEP 4

**PARTS REQUIRED**

6 - BACK PANEL x1

**HARDWARE REQUIRED**

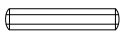
A  04

G  01

**TOOLS REQUIRED**

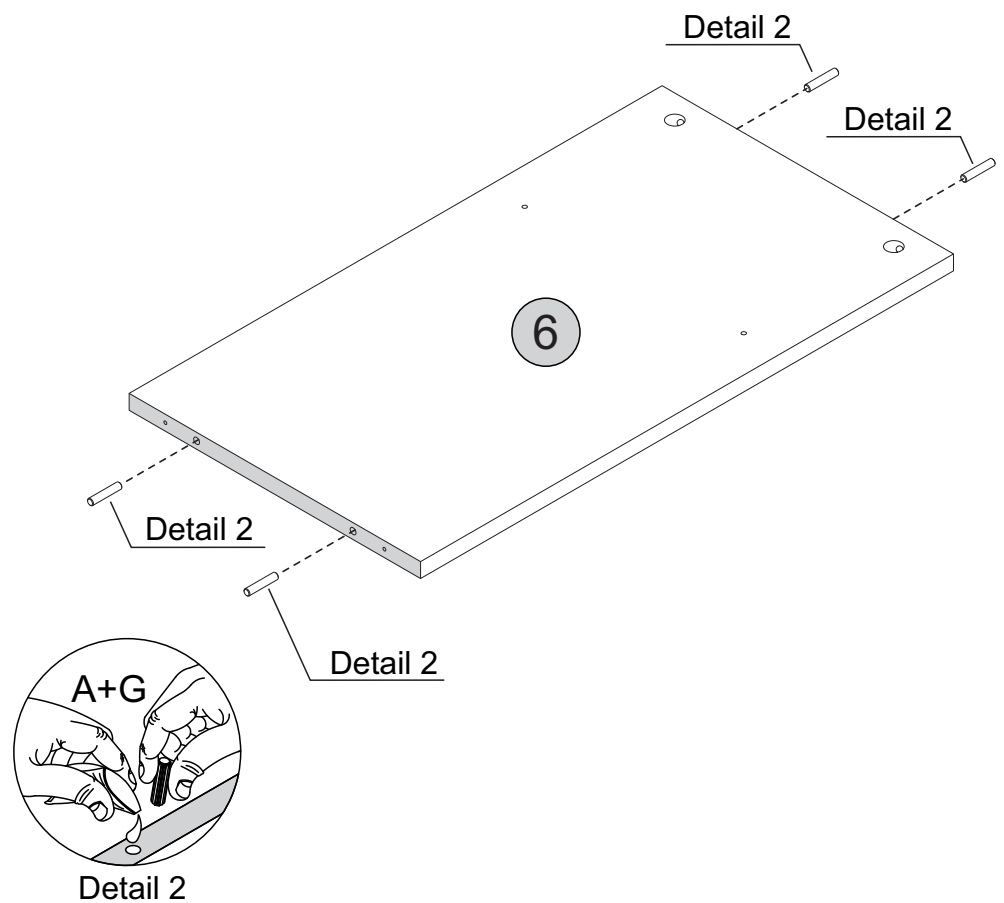
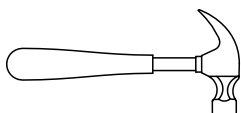

# STEP 5

## PARTS REQUIRED

3 - SHELF x1

## HARDWARE REQUIRED

A  02

B  01

G  01

## TOOLS REQUIRED

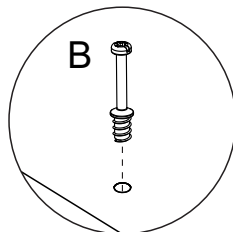
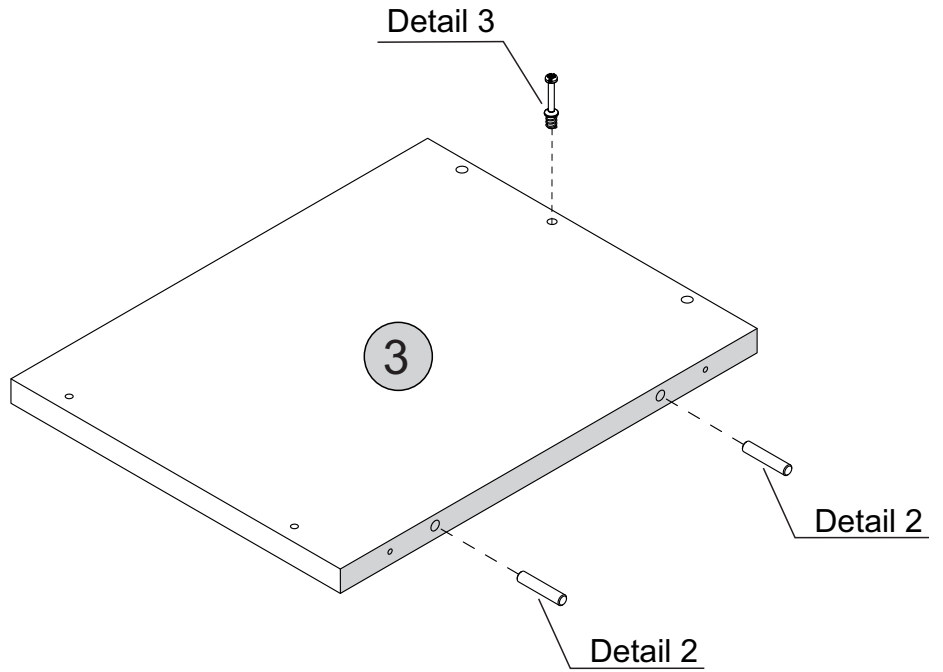
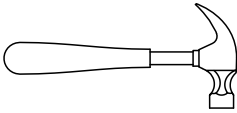
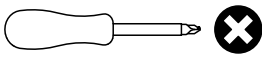

Detail 3

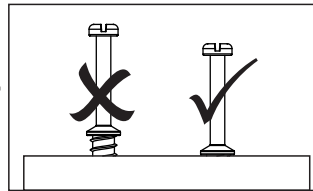

Detail 2

# STEP 6

## PARTS REQUIRED

4 - LEFT SIDE PANEL x1

## HARDWARE REQUIRED

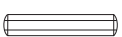
A  04

G  01

## TOOLS REQUIRED

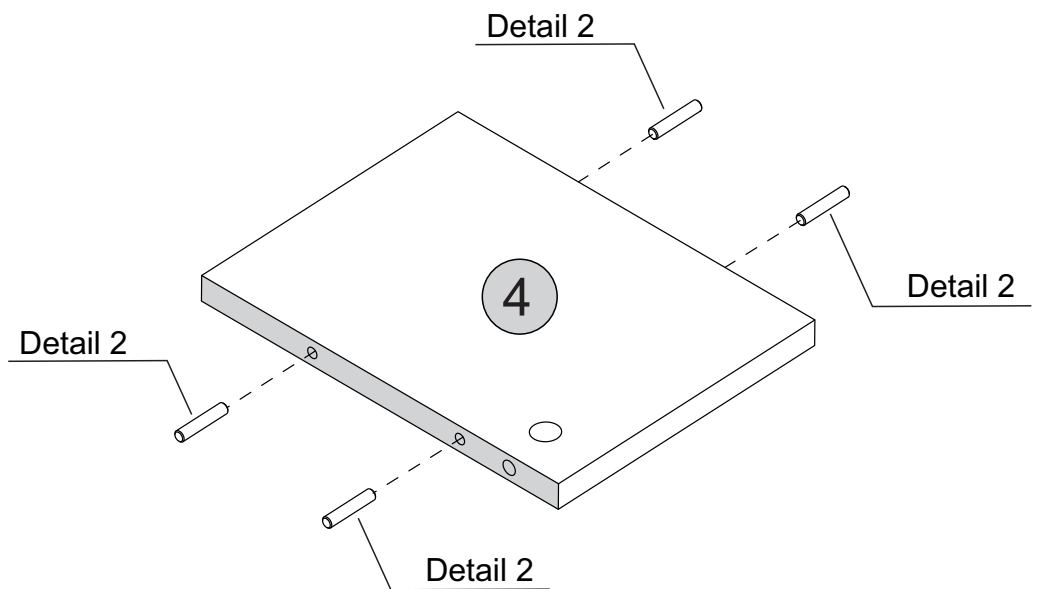
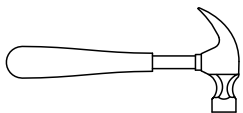

Detail 2

# STEP 7

## PARTS REQUIRED

3 - SHELF x1

4 - LEFT SIDE PANEL x1

## HARDWARE REQUIRED

D  02

G  01

## TOOLS REQUIRED

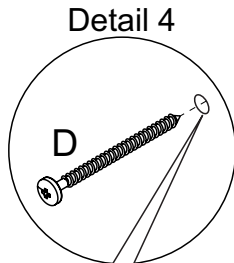
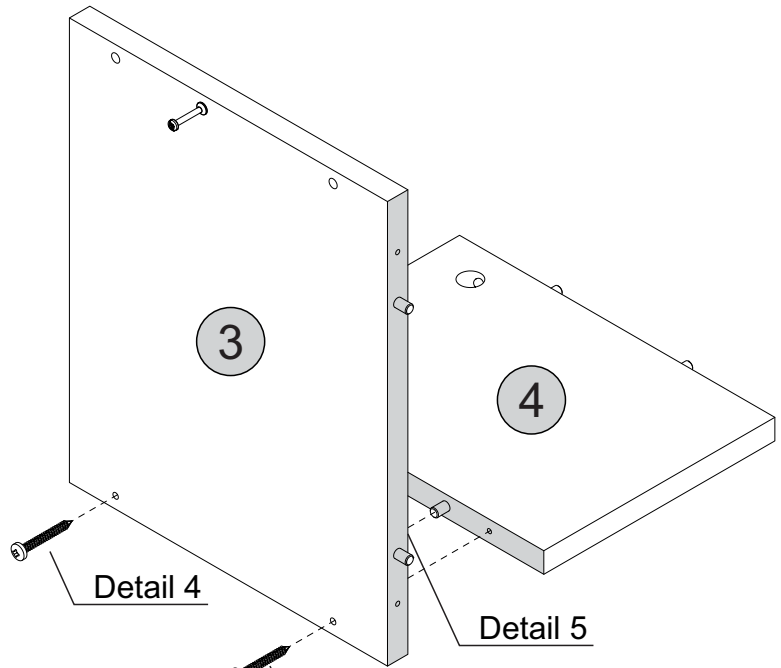
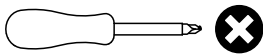

Please note:  
Pre-marked  
Holes



Detail 5

# STEP 8

## PARTS REQUIRED

6 - BACK PANEL x1

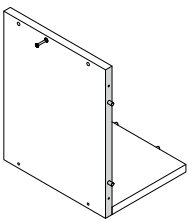

## HARDWARE REQUIRED

D  02

G  01

## TOOLS REQUIRED

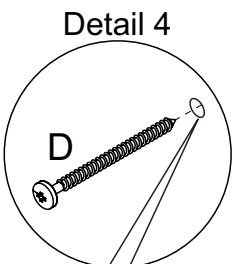
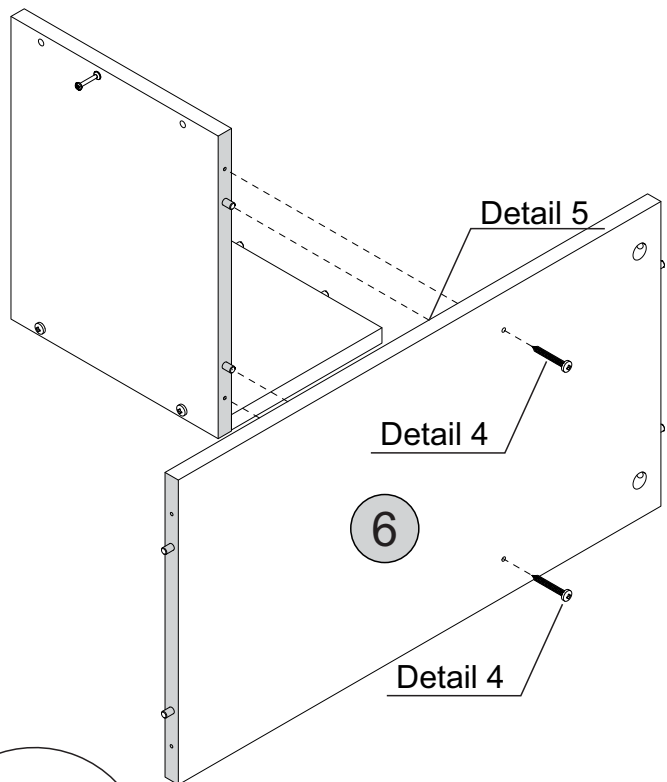
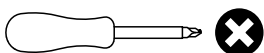

Please note:  
Pre-marked  
Holes

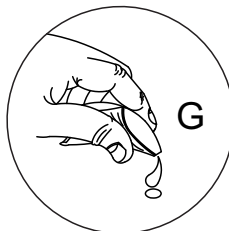

Detail 5

# STEP 9

## PARTS REQUIRED

2 - RIGHT SIDE PANEL x1

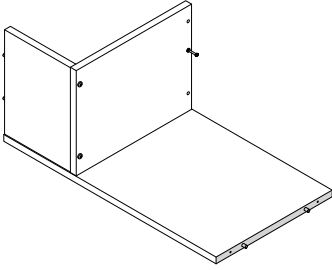

## HARDWARE REQUIRED

C  01

F  01

G  01

## TOOLS REQUIRED

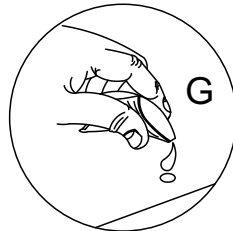
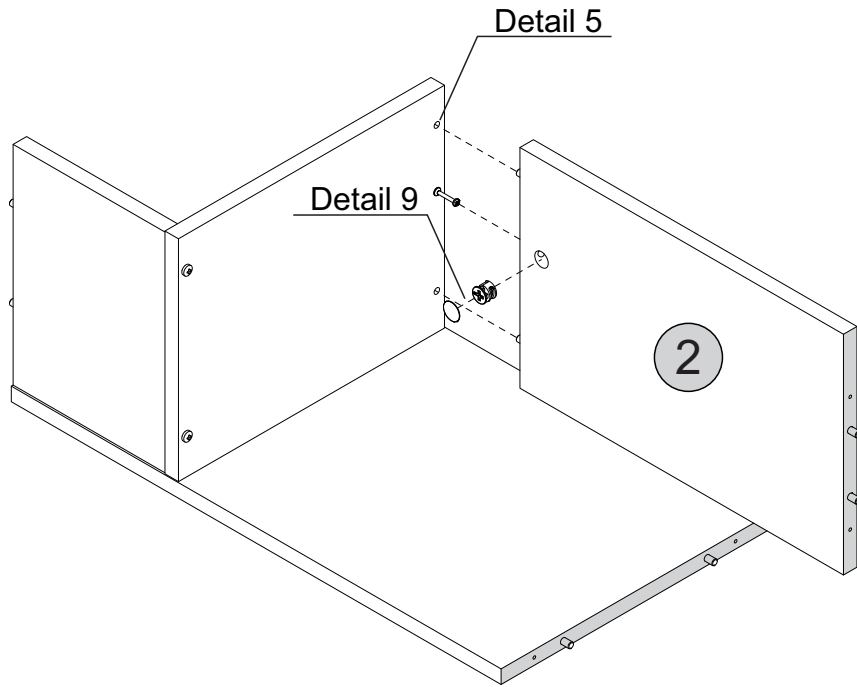
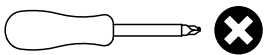

Detail 5

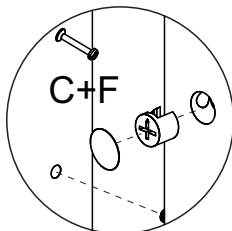

Detail 9

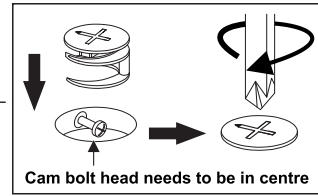

Cam bolt head needs to be in centre

# STEP 10

## PARTS REQUIRED

1 - BASE PANEL x1

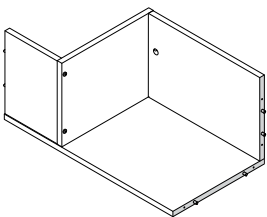

## HARDWARE REQUIRED

D  04

G  01

## TOOLS REQUIRED

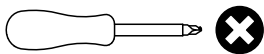

For your future reference order number should be here

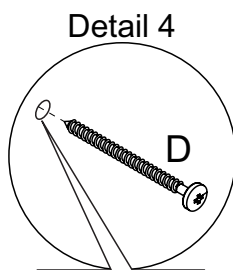
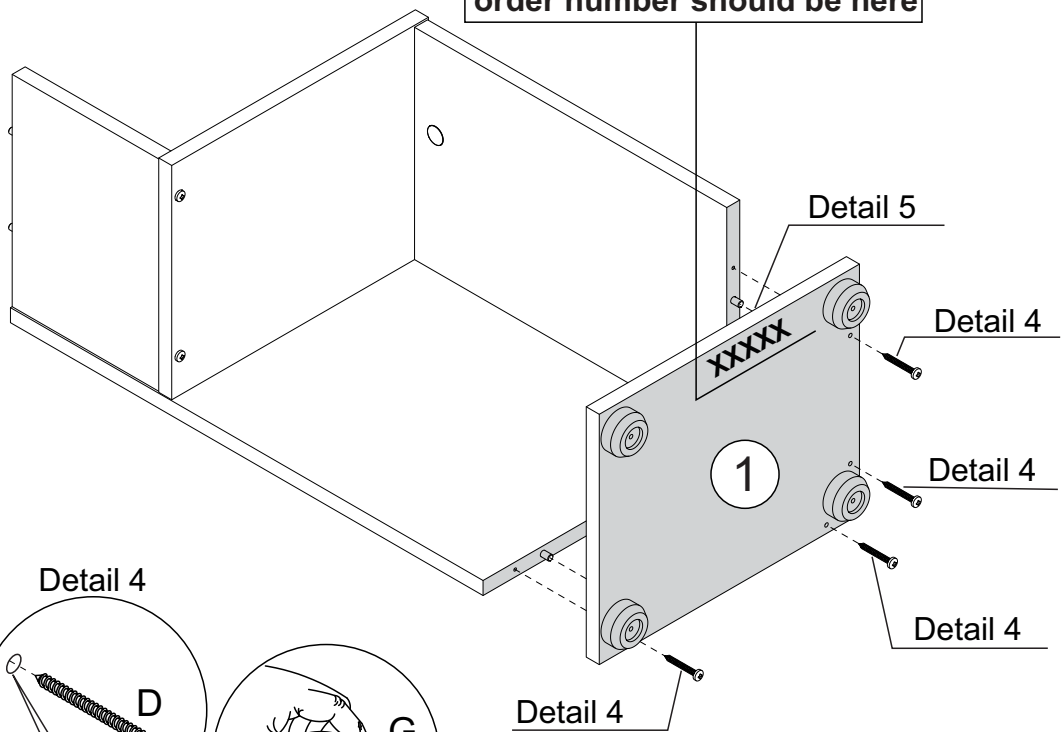

Detail 4

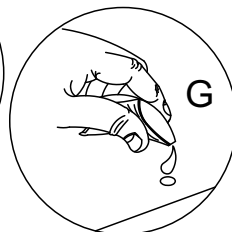

Detail 5

Please note:  
Pre-marked  
Holes



# STEP 11

**PARTS REQUIRED**

5 - TOP x1

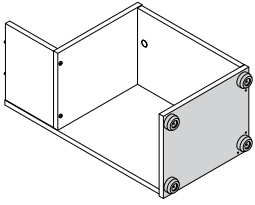

**HARDWARE REQUIRED**

C  03

F  03

G  01

**TOOLS REQUIRED**

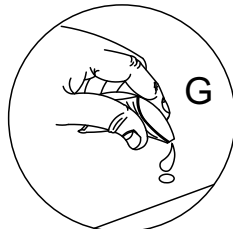
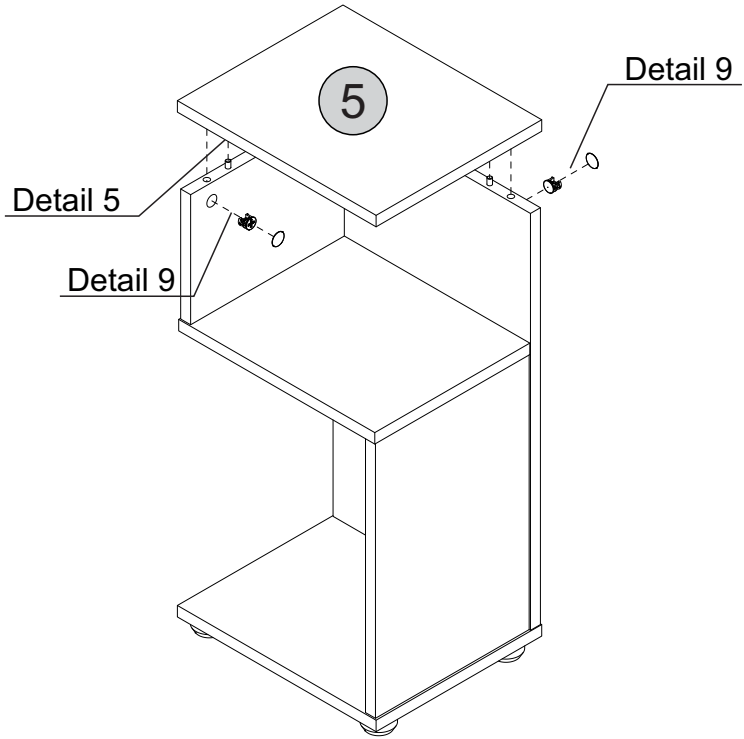
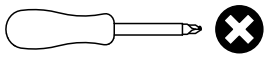

Detail 5

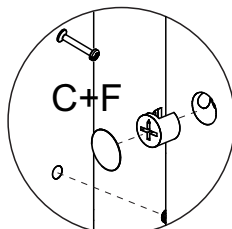

Detail 9

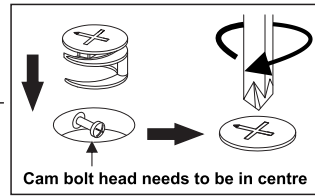

# STEP 12

**PARTS REQUIRED**

**HARDWARE REQUIRED**

**TOOLS REQUIRED**

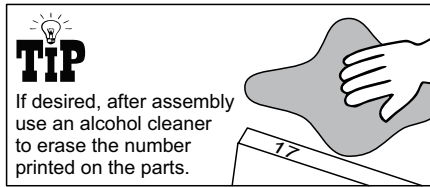

**TIP**

If desired, after assembly use an alcohol cleaner to erase the number printed on the parts.

