

CORONA CORNER TV CABINET ASSEMBLY INSTRUCTIONS

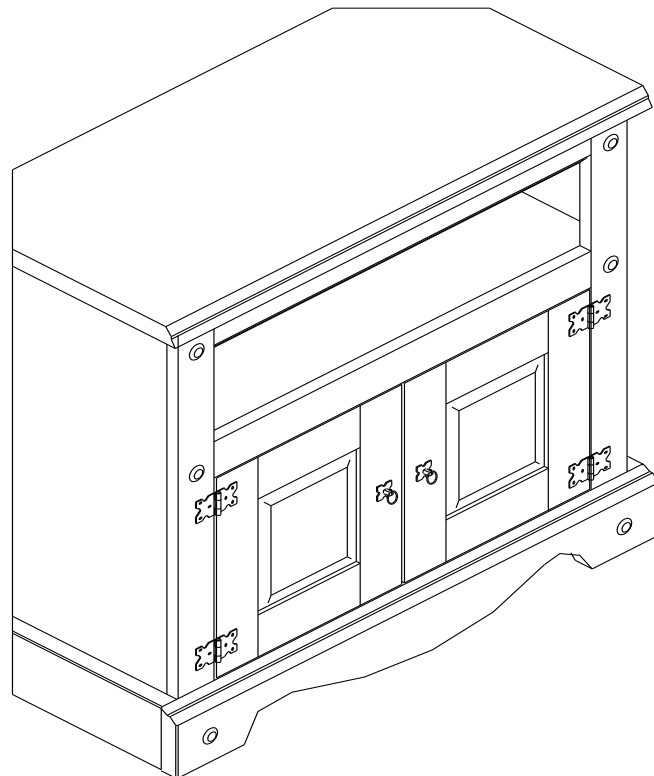

IMPORTANT PLEASE READ BEFORE YOU CONTINUE FURTHER FOR DOMESTIC USE ONLY CARE AND MAINTENANCE

After unpacking this product please keep the original packaging in case it needs to be returned for any reason.

- Please ensure all fittings and parts are present before commencing with assembly.
- We recommend that you lay a blanket or sheet on the floor to avoid damage to both your floor and the product.
- We strongly recommend that you keep children away from your work area.
- Assemble this product as close to its final position as possible.
- Never drag or push products as this could cause damage to the joints making it inferior.
- Do not place this product next to a radiator or in direct sunlight.
- Wood is a natural product and may expand if subjected to damp and may shrink or crack if subjected to heat. Therefore it is recommended that room temperature is maintained, with no sudden temperature fluctuations.
- Make sure any spillage is wiped off immediately.
- Do not place hot or chilled items directly on to the surface, use a place mat or marking will occur.
- For general cleaning use a duster, and do not use detergents of any kind. However, the surface will need to be retreated from time to time. This can be done by using block wax (unperfumed) and rubbing it over the whole item.
- From time to time it may be necessary to tighten fittings, regular inspections should be carried out.

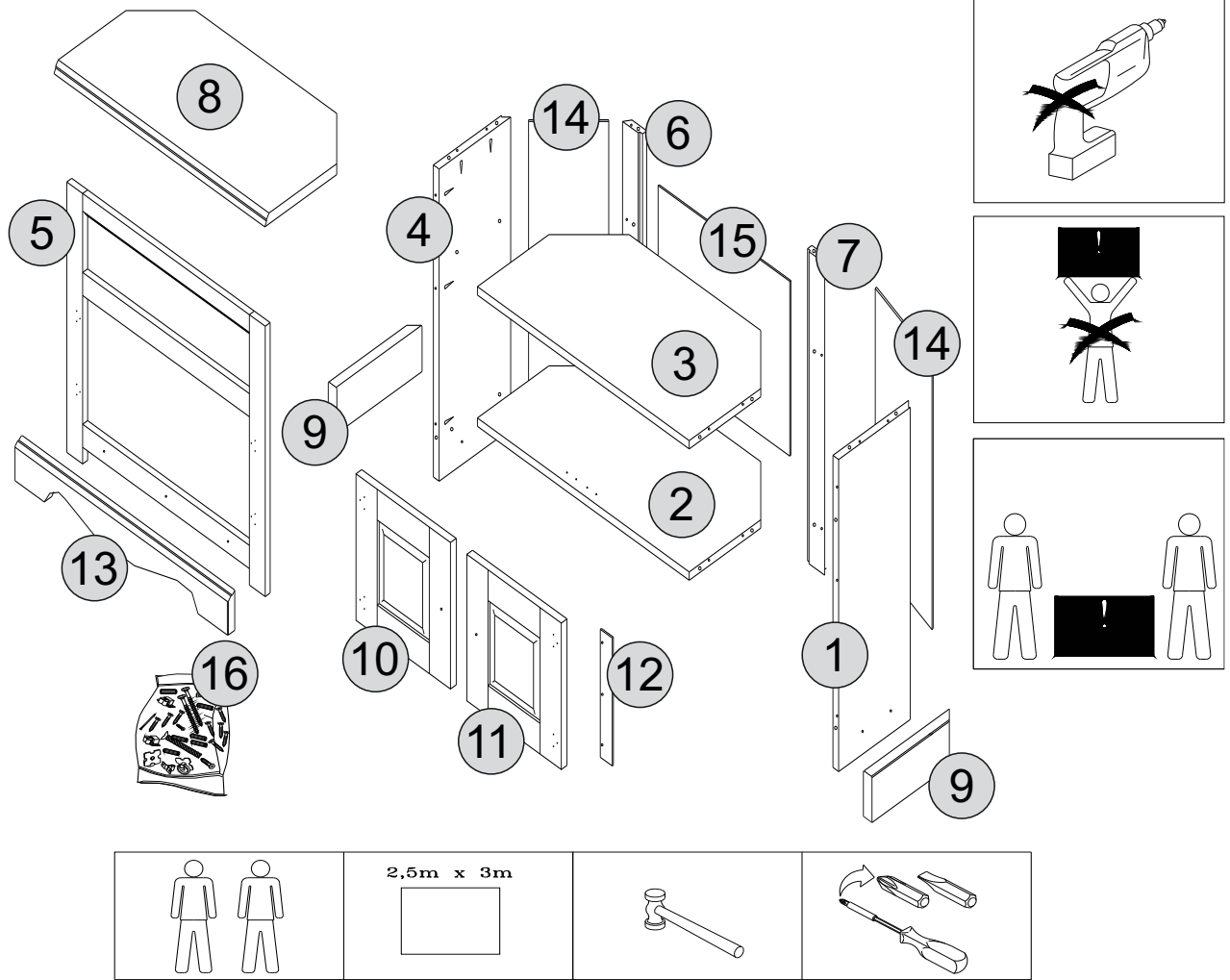









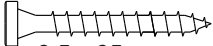

*** Use of power tools to assemble this product will invalidate any claim and damage this product making it unsafe !!!**
*** Please assemble on a clean soft surface to avoid damage.**

*** Please check contents and read the instructions before commencing assembly.**
*** Assemble this product following the enclosed instructions carefully.**
*** Please take care to avoid damaging panels during assembly.**

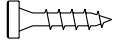
PARTS LIST

Part Number	Part Code	Part Description	Quantity	Carton
1	S300-305-009-MY1-01	Right Side Panel	1	1/1
2	S300-305-009-MY1-02	Base	1	1/1
3	S300-305-009-MY1-03	Fixed Shelf	1	1/1
4	S300-305-009-MY1-04	Left Side Panel	1	1/1
5	S300-305-009-MY1-05	Front Frame	1	1/1
6	S300-305-009-MY1-06	Left Side Back Upright	1	1/1
7	S300-305-009-MY1-07	Right Side Back Upright	1	1/1
8	S300-305-009-MY1-08	Top Panel	1	1/1
9	S300-305-009-MY1-09	Side Plinth	2	1/1
10	S300-305-009-MY1-10	Left Door	1	1/1
11	S300-305-009-MY1-11	Right Door	1	1/1
12	S300-305-009-MY1-12	Door Strip	1	1/1
13	S300-305-009-MY1-13	Front Plinth	1	1/1
14	S300-305-009-MY1-14	Small Back Panel	2	1/1
15	S300-305-009-MY1-15	Large Back Panel	1	1/1
16	S300-305-009-MY1-16	Hardware Kit	1	1/1

FITTINGS

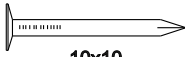
A	  3,5 x 35	31	F	 8,0 x 30	22
B		02	G		06
C	  3,5x16	35	H		04
D	 	02	I	   2x 1x	01
E	 10x10	30			



- * Please check contents and read the instructions before commencing assembly.
- * Assemble this product following the enclosed instructions carefully.
- * Please take care to avoid damaging parts during assembly.

STEP 1

PARTS REQUIRED

1 - RIGHT SIDE PANEL	x1
2 - BASE	x1
3 - FIXED SHELF	x1

HARDWARE REQUIRED

F		16
8,0 x 30		

TOOLS REQUIRED

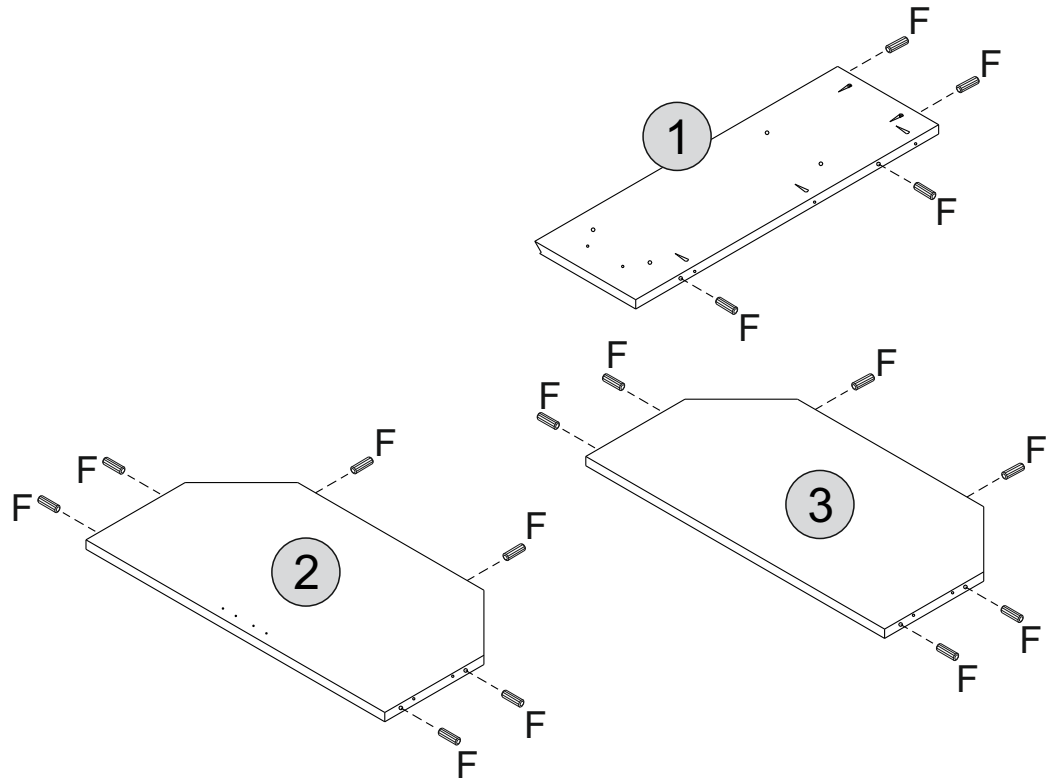

 Please assemble on a clean soft surface to avoid damage.

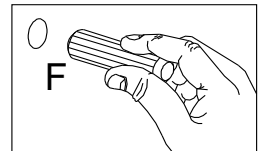

STEP 2

PARTS REQUIRED

4 - LEFT SIDE PANEL	x1
6 - LEFT SIDE BACK UPRIGHT	x1
7 - RIGHT SIDE BACK UPRIGHT	x1

HARDWARE REQUIRED

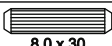
F		06
8,0 x 30		

TOOLS REQUIRED

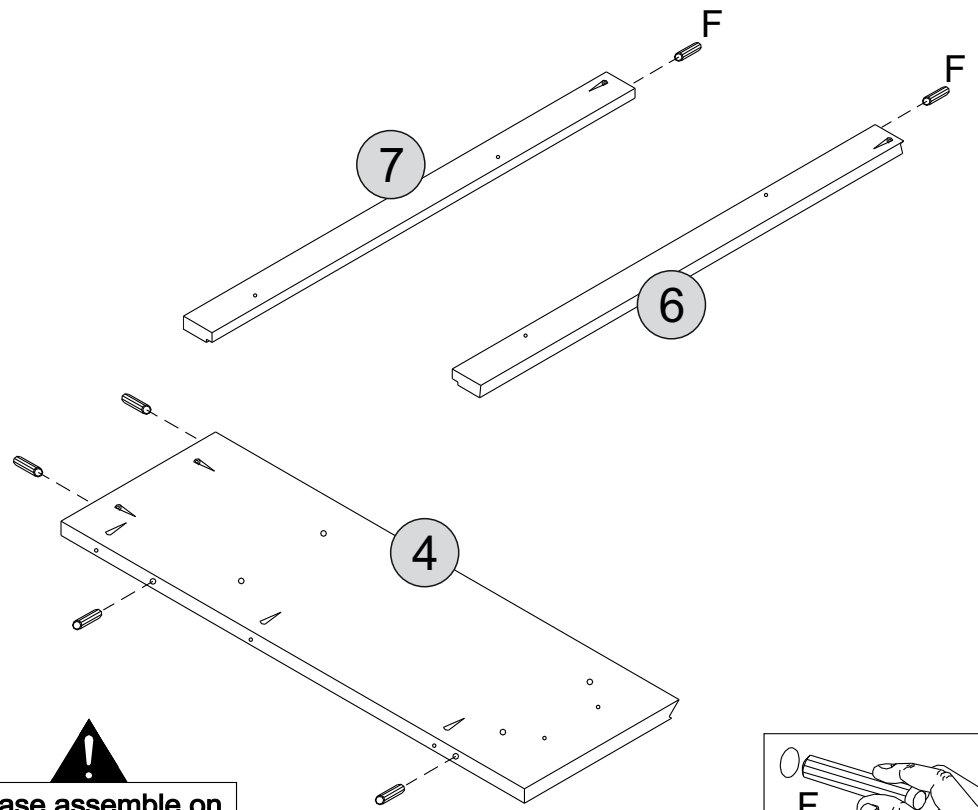

 Please assemble on a clean soft surface to avoid damage.

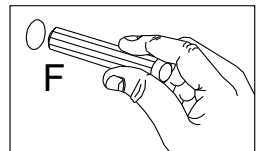

STEP 3

PARTS REQUIRED

- 1 - RIGHT SIDE PANEL x1
- 2 - BASE x1
- 3 - FIXED SHELF x1
- 4 - LEFT SIDE PANEL x1

HARDWARE REQUIRED

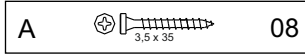

TOOLS REQUIRED

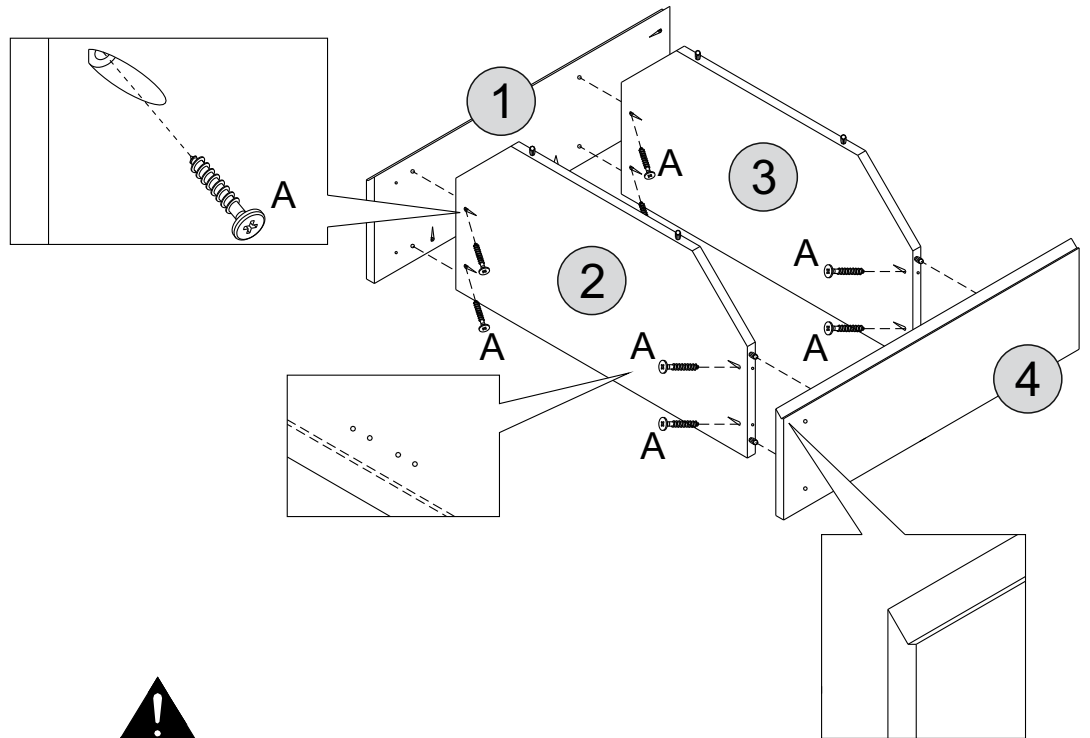
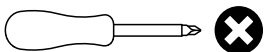

!
Please assemble on a clean soft surface to avoid damage.

STEP 4

PARTS REQUIRED

- 5 - FRONT FRAME x1

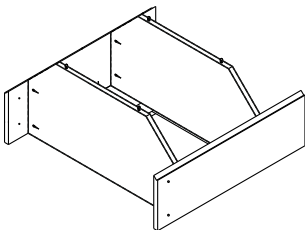

HARDWARE REQUIRED

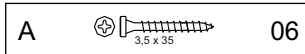

TOOLS REQUIRED

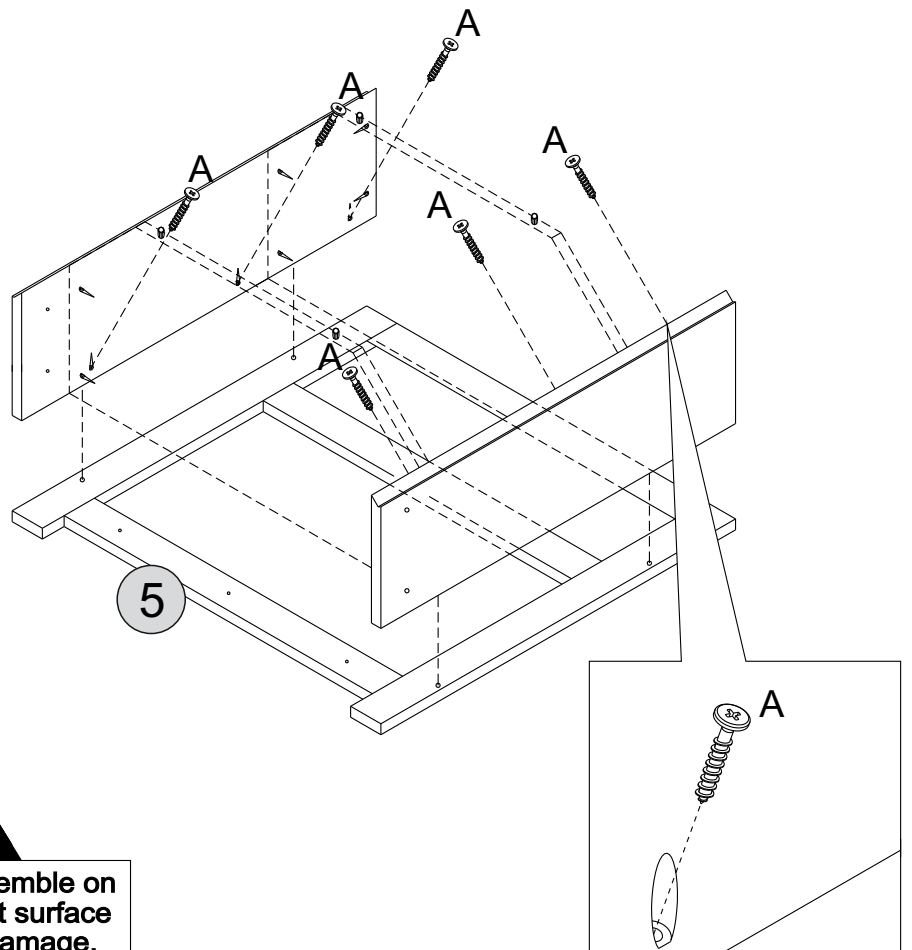
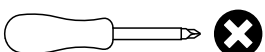

!
Please assemble on a clean soft surface to avoid damage.

STEP 5

PARTS REQUIRED

6 - LEFT SIDE BACK UPRIGHT x1

7 - RIGHT SIDE BACK UPRIGHT x1

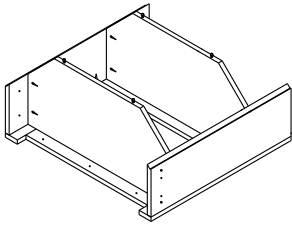

HARDWARE REQUIRED

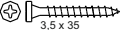
A  04
3,5 x 35

TOOLS REQUIRED

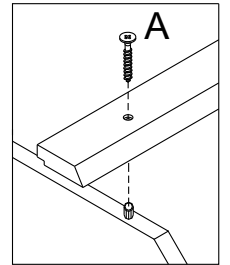
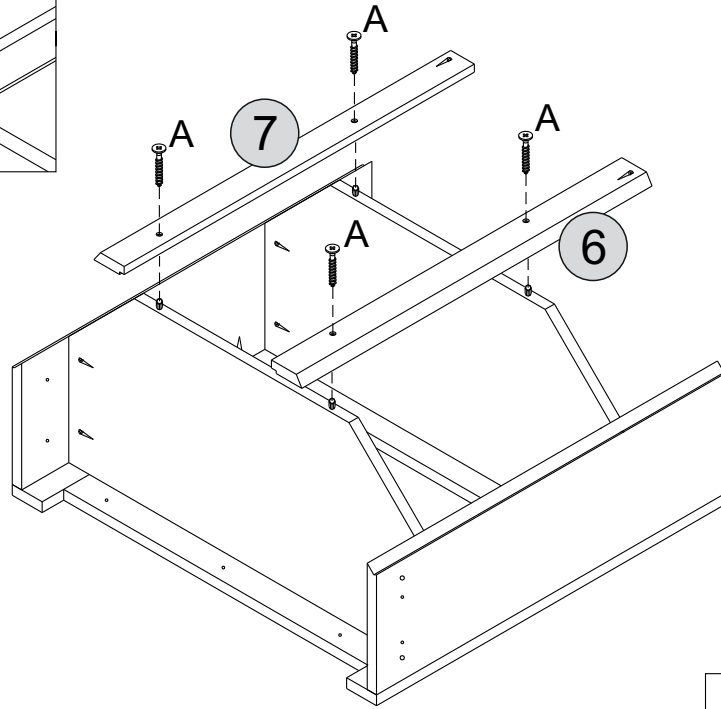
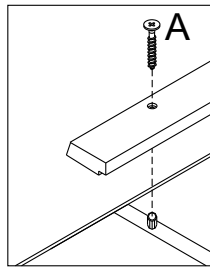
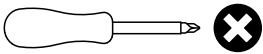

Please assemble on a clean soft surface to avoid damage.

STEP 6

PARTS REQUIRED

8 - TOP PANEL x1

9 - SIDE PLINTH x2

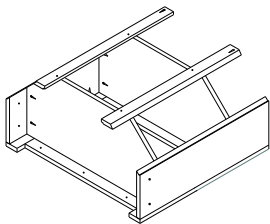

HARDWARE REQUIRED

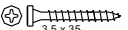
A  10
3,5 x 35

TOOLS REQUIRED

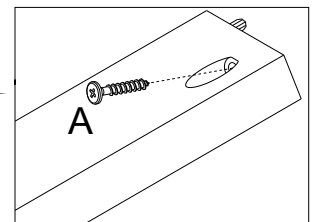
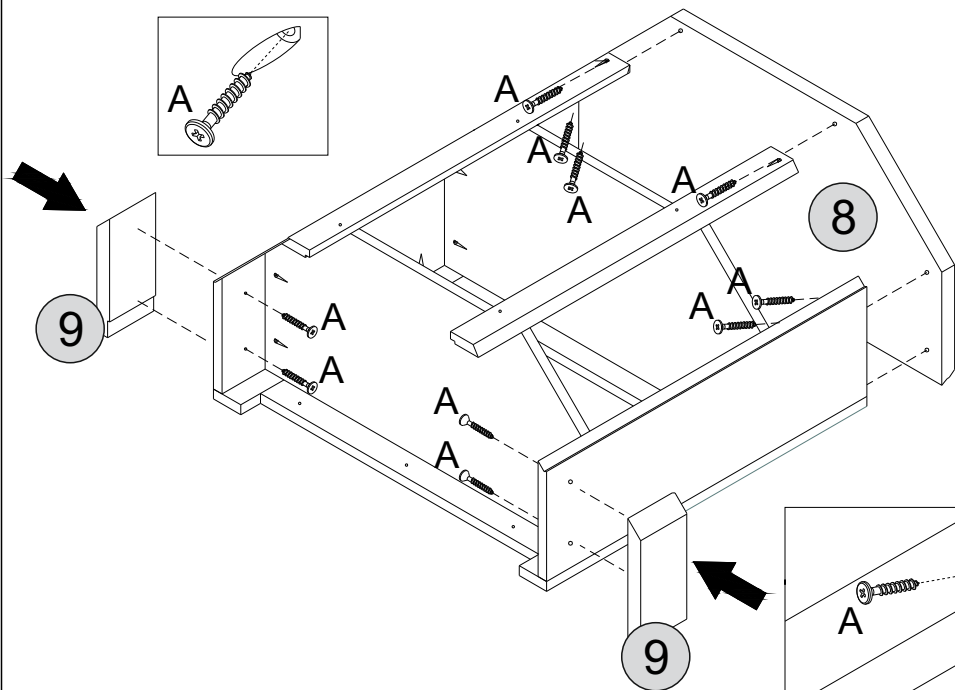
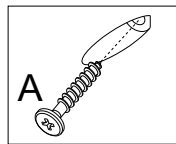
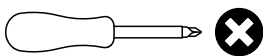

Please assemble on a clean soft surface to avoid damage.

STEP 7

PARTS REQUIRED

14 - SMALL BACK PANEL x2

15 - LARGE BACK PANEL x1

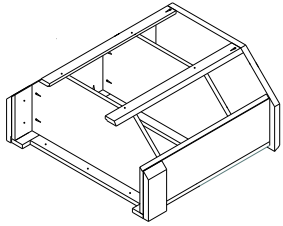

HARDWARE REQUIRED

E  30
10x10

TOOLS REQUIRED

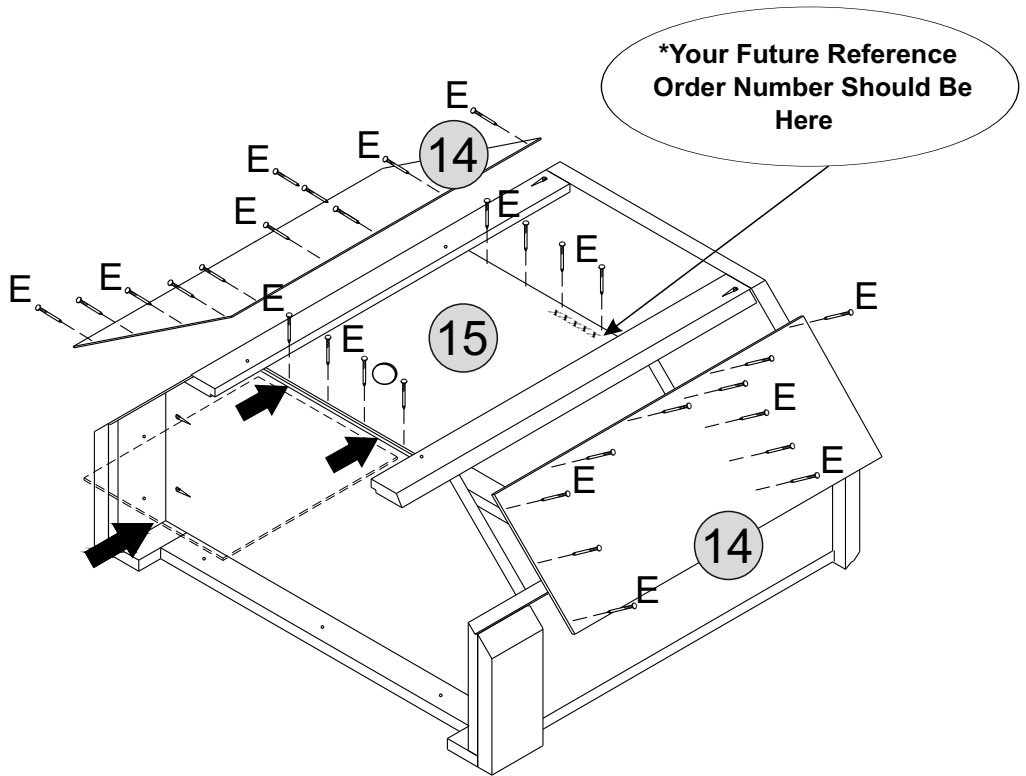
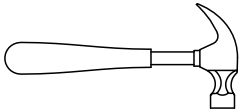

 Please assemble on a clean soft surface to avoid damage.

STEP 8

PARTS REQUIRED

13 - FRONT PLINTH x1

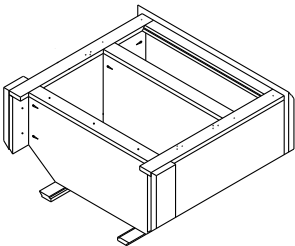

HARDWARE REQUIRED

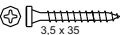
A  03
3,5 x 35

TOOLS REQUIRED

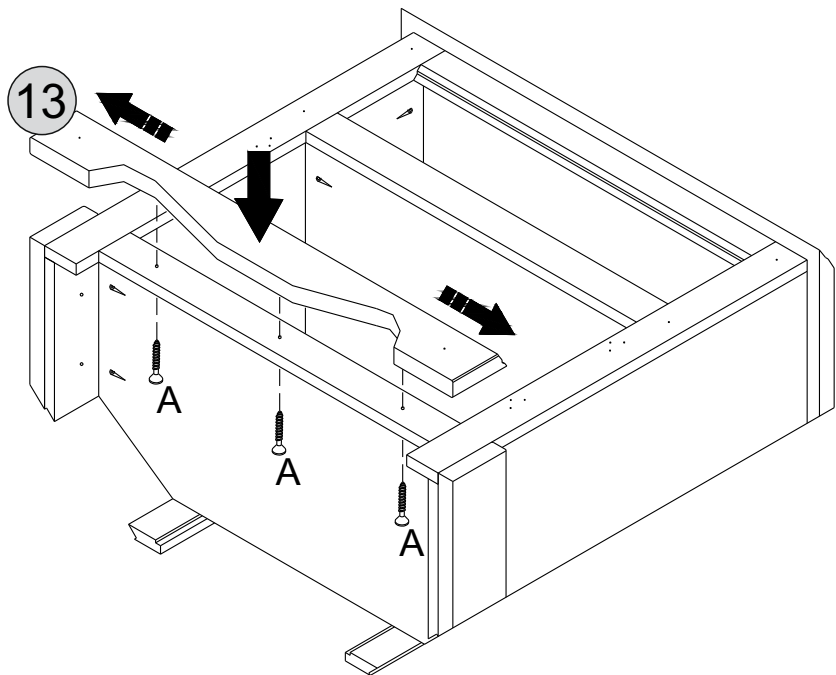
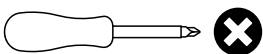

 Please assemble on a clean soft surface to avoid damage.

STEP 9

PARTS REQUIRED

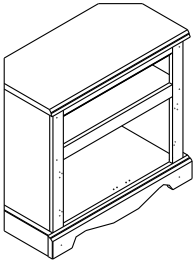

HARDWARE REQUIRED

B		02
C		04
G		06

TOOLS REQUIRED

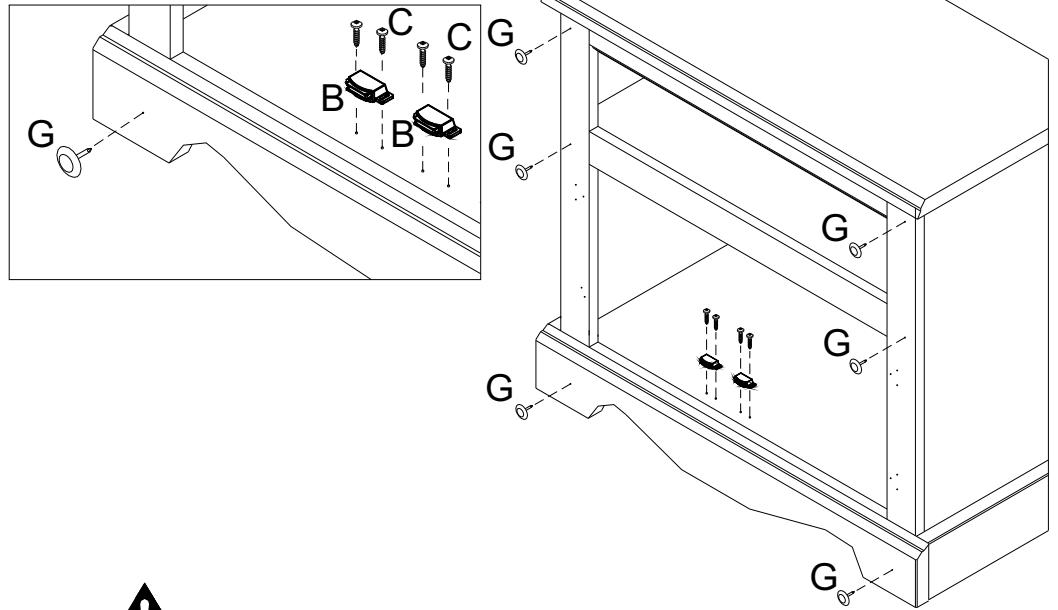
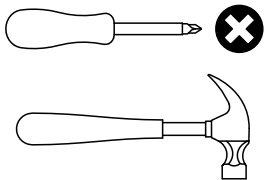

!
Please assemble on a clean soft surface to avoid damage.

STEP 10

PARTS REQUIRED

10 - LEFT DOOR	x1
12 - DOOR STRIP	x1

HARDWARE REQUIRED

B		01
C		11
D		01
H		02

TOOLS REQUIRED

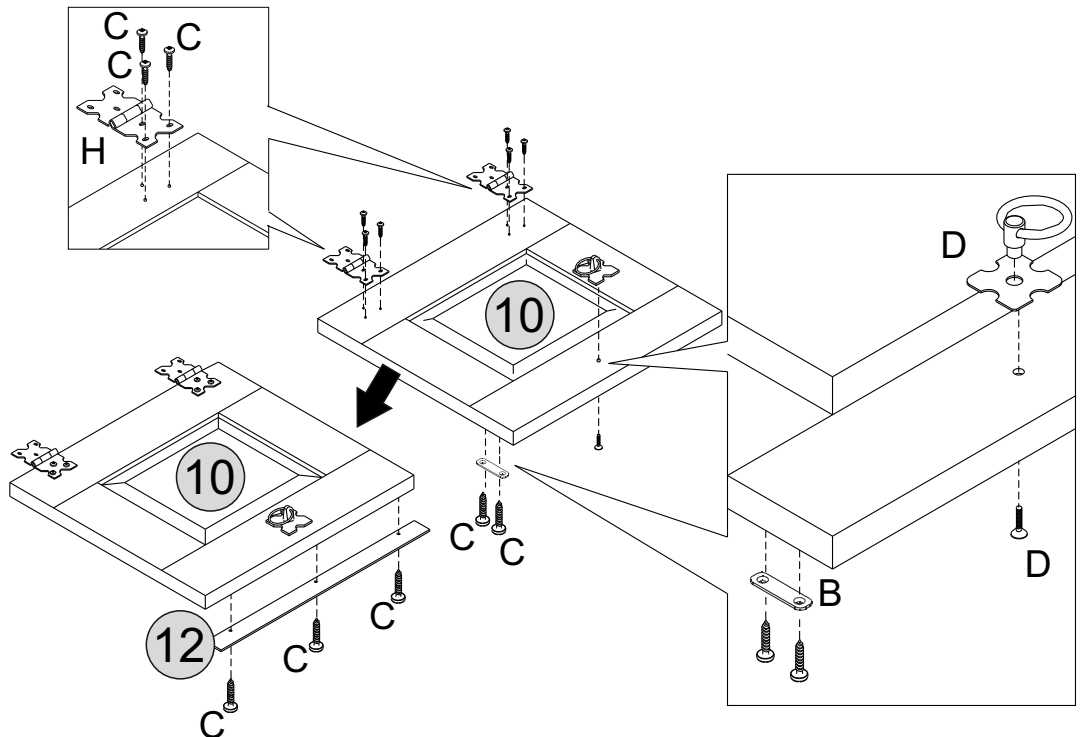
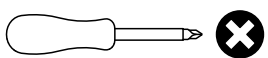



!
Please assemble on a clean soft surface to avoid damage.

STEP 11

PARTS REQUIRED

11 - RIGHT DOOR x1

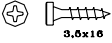
HARDWARE REQUIRED

- B  01
- C  08
- D  01
- H  02

TOOLS REQUIRED

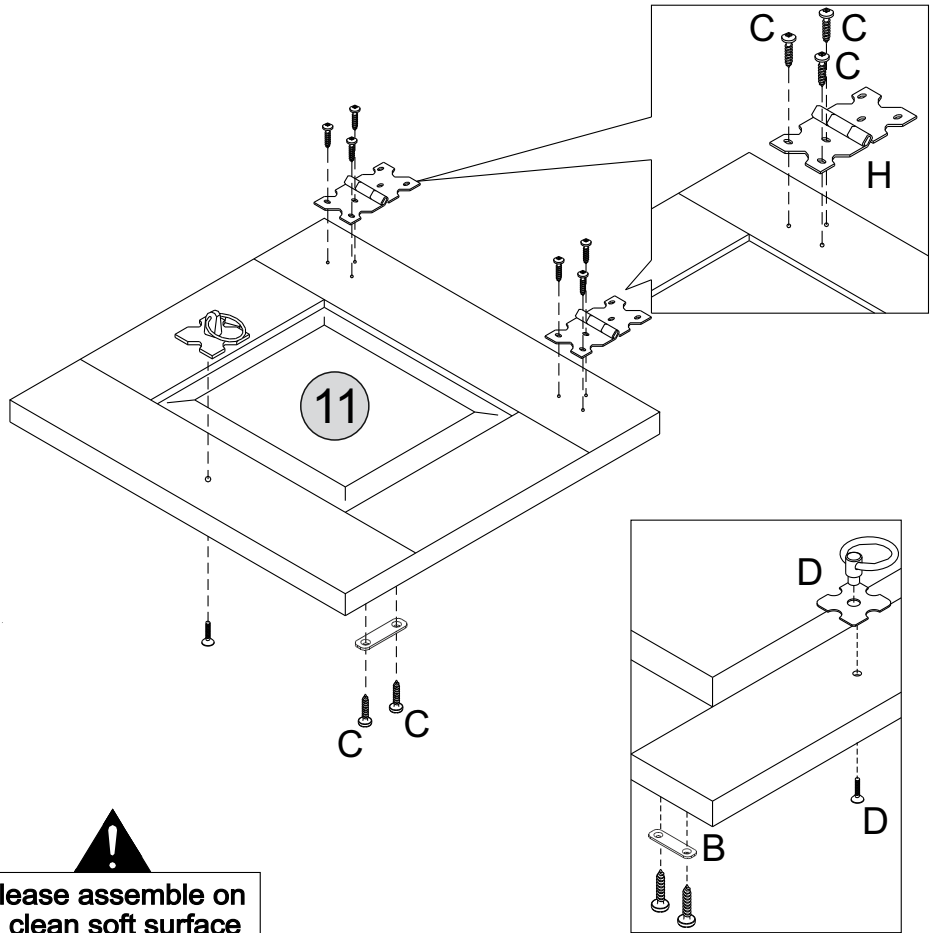
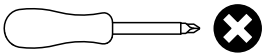

 Please assemble on a clean soft surface to avoid damage.

STEP 12

PARTS REQUIRED

10 - LEFT DOOR x1

11 - RIGHT DOOR x1

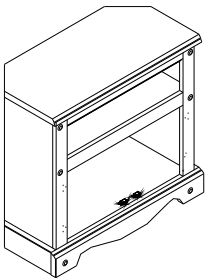

HARDWARE REQUIRED

- C  12

TOOLS REQUIRED

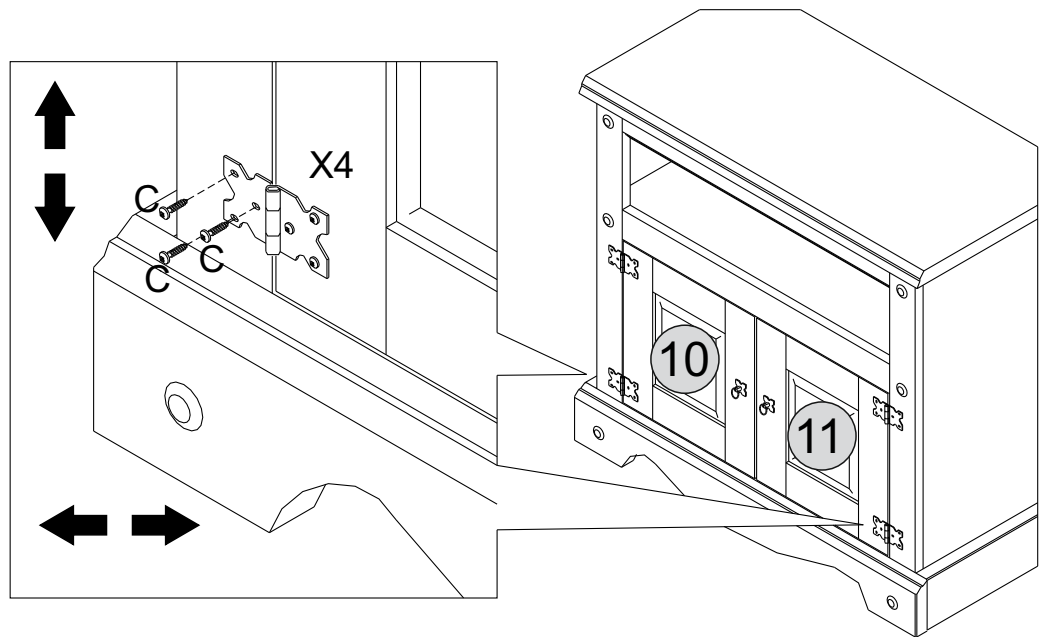
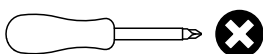

 Please assemble on a clean soft surface to avoid damage.

WARNING

Serious or fatal injuries can occur from furniture tipping over. To prevent the furniture from tipping over we recommend that it is permanently fixed to the wall.

Wall fixings are not supplied with this product as different wall materials require different types of fixing devices.
Please make sure you use fixings suitable for the walls in your home.

I - HARDWARE LIST



Strap (Anti-Tip Kit)
(1x)



Wood Screw (Anti-Tip Kit)
3,5 x 25mm (1x)



Washer (Anti-Tip Kit)
(2x)

