

LEON 2 DOOR TV UNIT ASSEMBLY INSTRUCTIONS

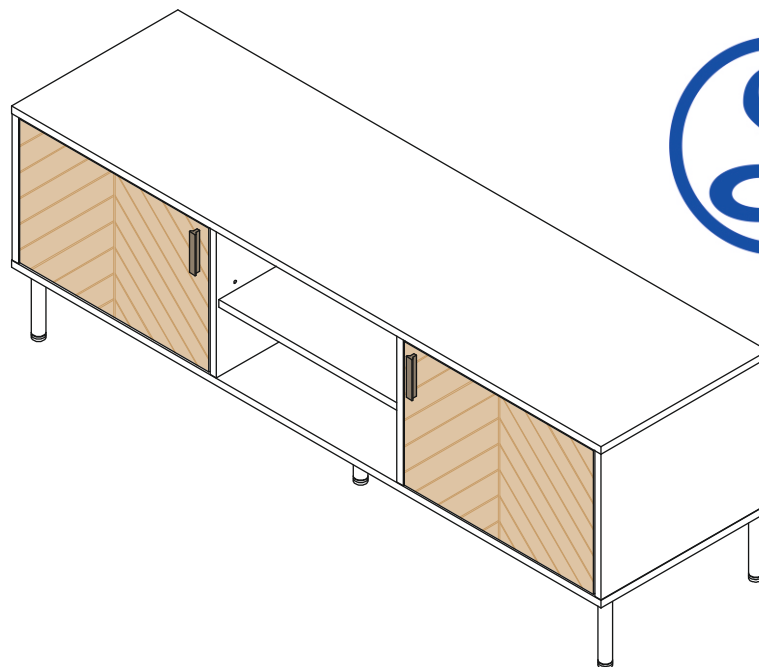

FOR DOMESTIC USE ONLY IMPORTANT PLEASE READ BEFORE YOU CONTINUE FURTHER

THE PRODUCT YOU HAVE PURCHASED WILL GIVE YOU MANY YEARS OF SERVICE IF YOU FOLLOW THE GUIDELINES FOR ITS SAFE ASSEMBLY AND PERIODIC MAINTENANCE AND CLEANING.

ASSEMBLE ON A SOFT CLEAN SURFACE.

DO NOT USE ANY TOOLS OTHER THAN THOSE SHOWN.

ANY SPANNERS OR ALLEN KEYS REQUIRED ARE INCLUDED WITH THE FITTING KIT.

DO NOT FOR ANY REASON USE A POWER TOOL TO ASSEMBLE THIS PRODUCT. ITS USE WILL INVALIDATE ANY CLAIM YOU MAY HAVE AND COULD MAKE THIS PRODUCT UNSAFE.

DEPENDING ON THE AMOUNT OF USE THIS PRODUCT RECEIVES, IT MAY BE NECESSARY TO TIGHTEN UP THE FIXINGS FROM TIME TO TIME. THIS IS COMPLETELY NORMAL FOR ANY FLAT PACK FURNITURE. DO NOT OVERTIGHTEN FIXINGS.

FOR CLEANING, YOU MAY USE A DAMP CLOTH (NOT WET). DO NOT USE POLISH, DETERGENT OR CHEMICAL CLEANERS.



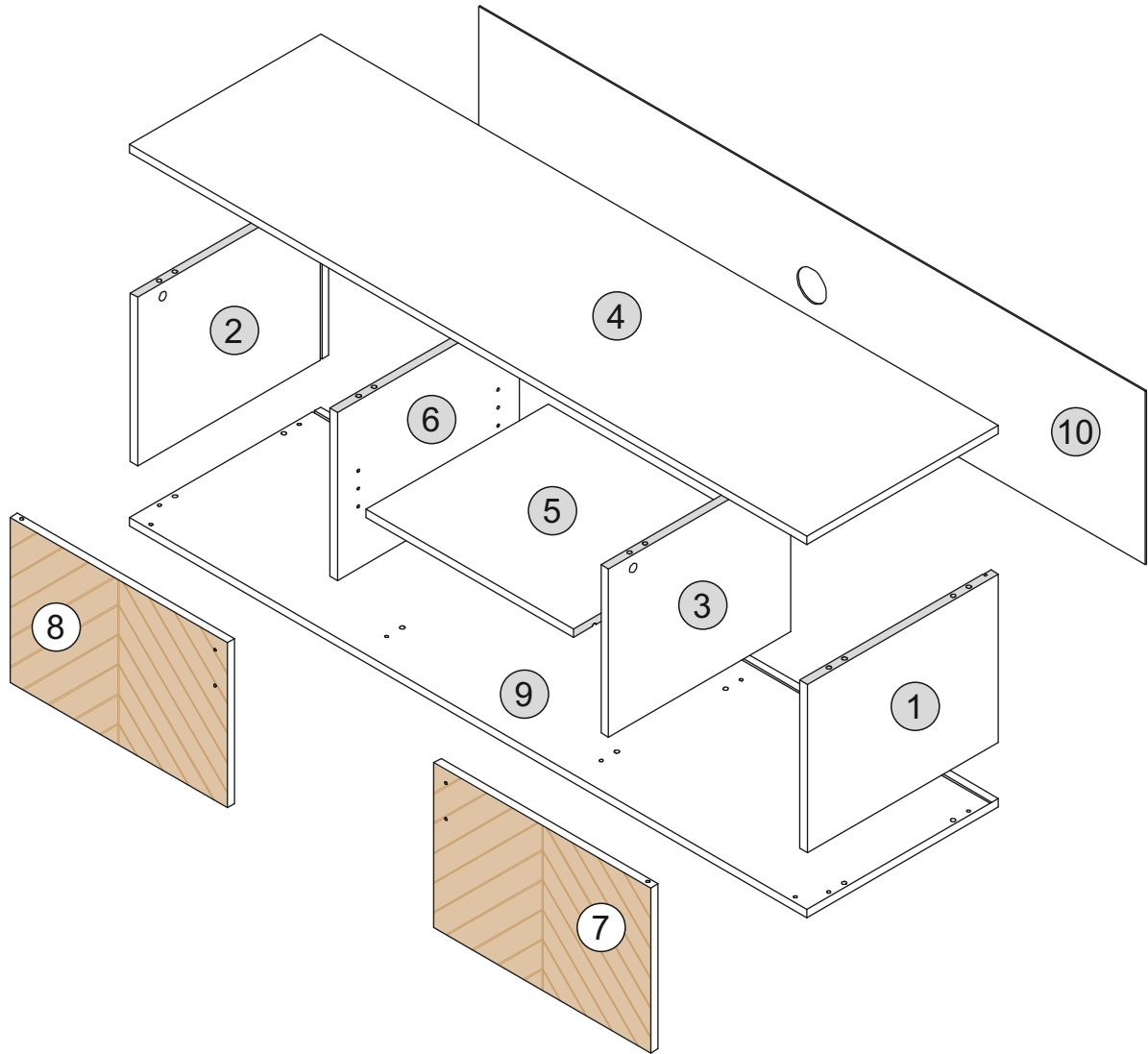













THIS SURFACE OF THIS ITEM IS NOT HEAT RESISTANT. ALWAYS USE A PLACE MAT UNDER HOT OR COLD ITEMS TO PREVENT MARKING.



PART LIST

Part Number	Part Code	Part Description	Quantity	Carton
1	S300-305-055-ZF1-01	Right Side Panel	1	1/1
2	S300-305-055-ZF1-02	Left Side Panel	1	1/1
3	S300-305-055-ZF1-03	Right Centre Panel	1	1/1
4	S300-305-055-ZF1-04	Top Panel	1	1/1
5	S300-305-055-ZF1-05	Adjustable Shelf Panel	1	1/1
6	S300-305-055-ZF1-06	Left Centre Panel	1	1/1
7	S300-305-055-ZF1-07	Right Door	1	1/1
8	S300-305-055-ZF1-08	Left Door	1	1/1
9	S300-305-055-ZF1-09	Bottom Panel	1	1/1
10	S300-305-055-ZF1-10	Back Panel	1	1/1

HARDWARE LIST

No	Part Name		Qty	Carton
A	M8x30mm Wooden Dowel		x16	1
B	Minifix Cam Bolt (8032t)		x8	1
C	Minifix Cam Nut (1512)		x8	1
D	M3.5x16mm Screw		x20	1
E	M4x45mm Screw		x8	1
F	Iron Leg (150mm) - Black		x5	1
G	20mm Handle Screw		x4	1
H	Handle (64mm)		x2	1
I	Metal Door		x4	1
J	Corner Support (AC101)		x2	1
K	M4x20mm Screw		x4	1
L	M3.5x14mm Screw		x2	1
M	Magnet		x2	1
N	Plate		x2	1
O	Nail		x8	1
P	Iron Shelf Support		x4	1

TIPS FOR FITTINGS CAM-LOCKS

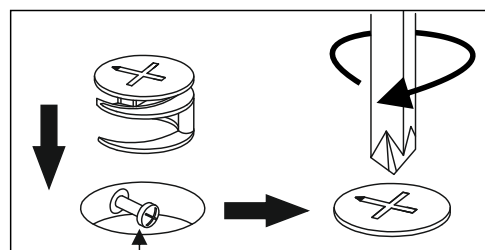
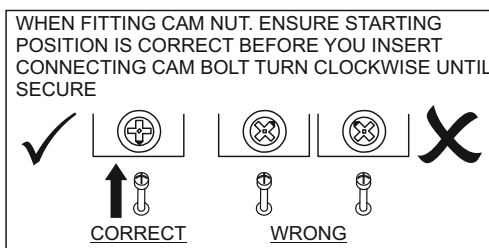

Cam bolt head needs to be in centre

CAMBOLT

Tighten until shoulder in flush with panel. Do not overtighten or undertighten (see example below)

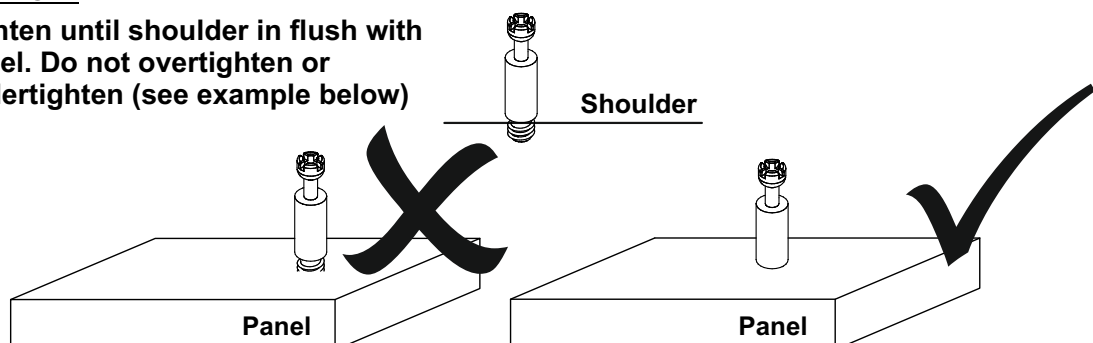

STEP 1

PARTS REQUIRED

1 - RIGHT SIDE PANEL x1

2 - LEFT SIDE PANEL x1

HARDWARE REQUIRED

A  08

C  04

TOOLS REQUIRED

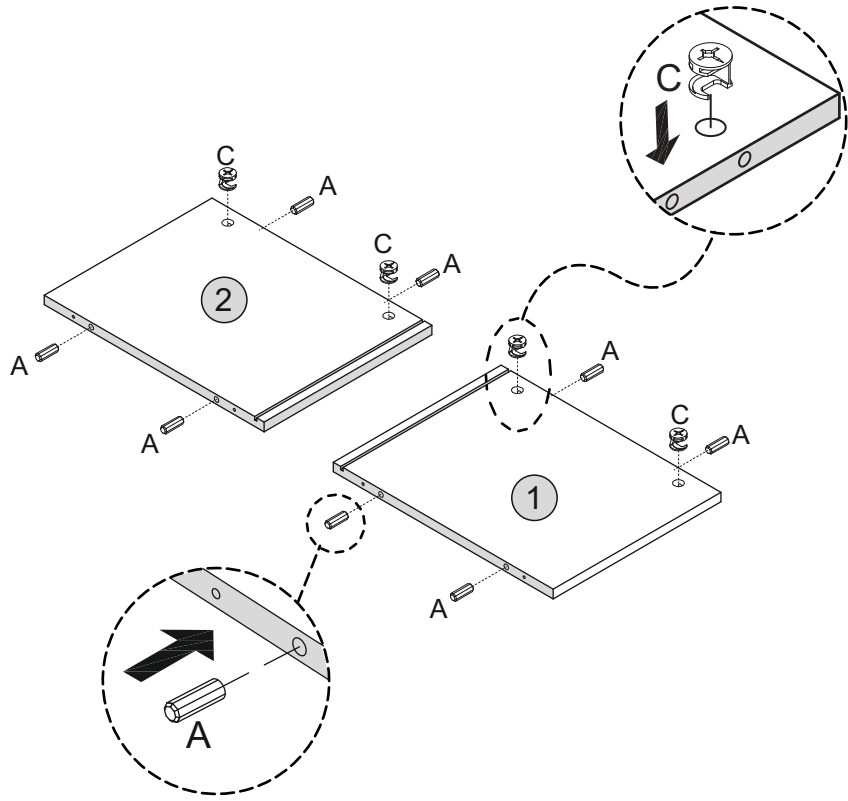
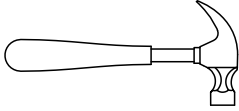

STEP 2

PARTS REQUIRED

3 - RIGHT CENTRE PANEL x1

6 - LEFT CENTRE PANEL x1

HARDWARE REQUIRED

A  08

C  04

P  04

TOOLS REQUIRED

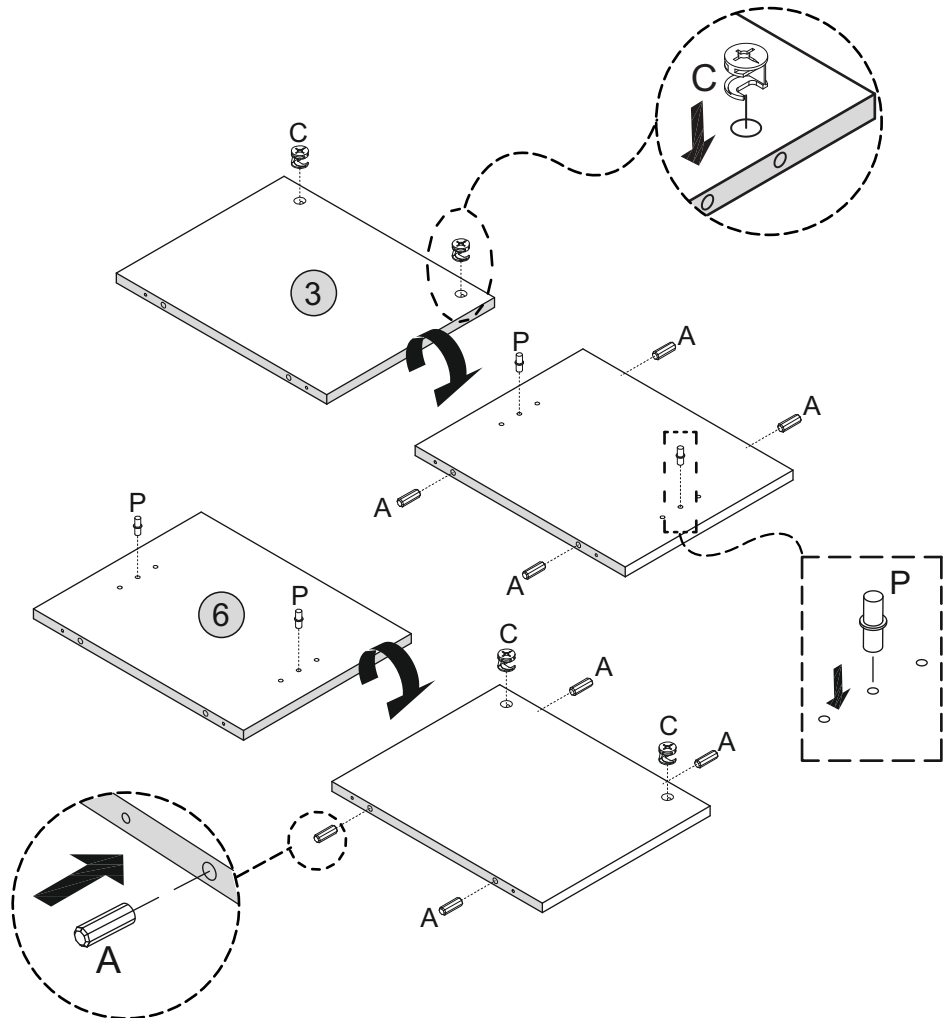
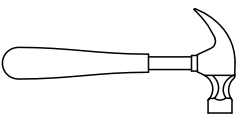

STEP 3

PARTS REQUIRED

4 - TOP PANEL x1

HARDWARE REQUIRED

B  08

M  02

TOOLS REQUIRED

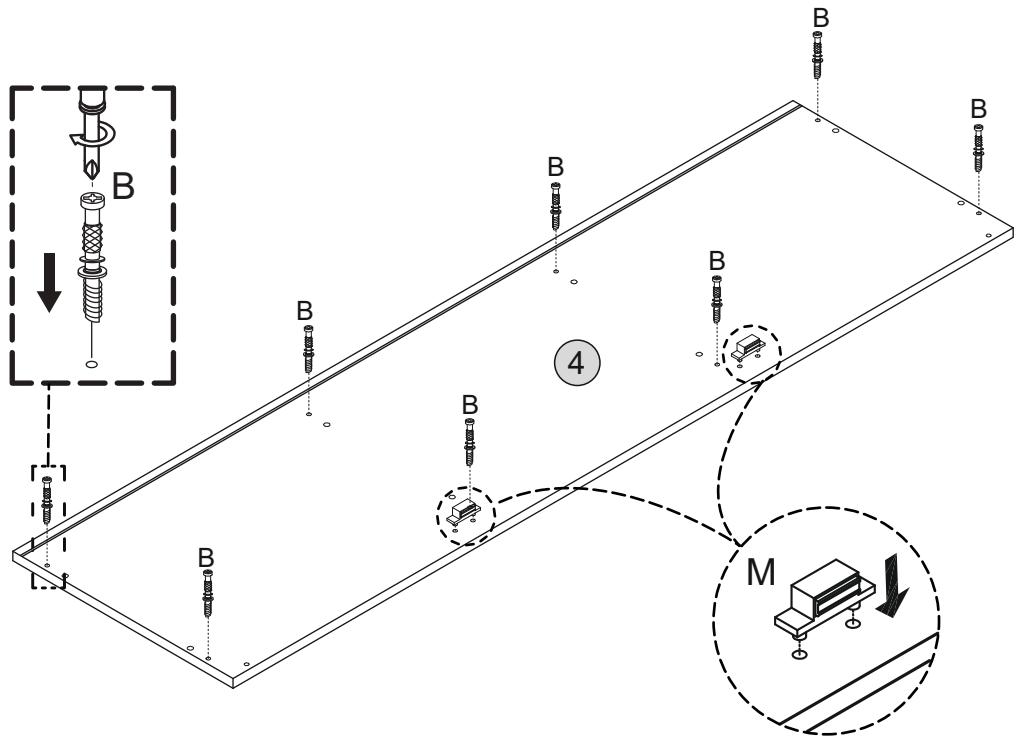
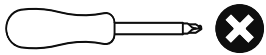

STEP 4

PARTS REQUIRED

7 - RIGHT DOOR x1

8 - LEFT DOOR x1

HARDWARE REQUIRED

I  04

L  3.5x14mm 02

N  02

TOOLS REQUIRED

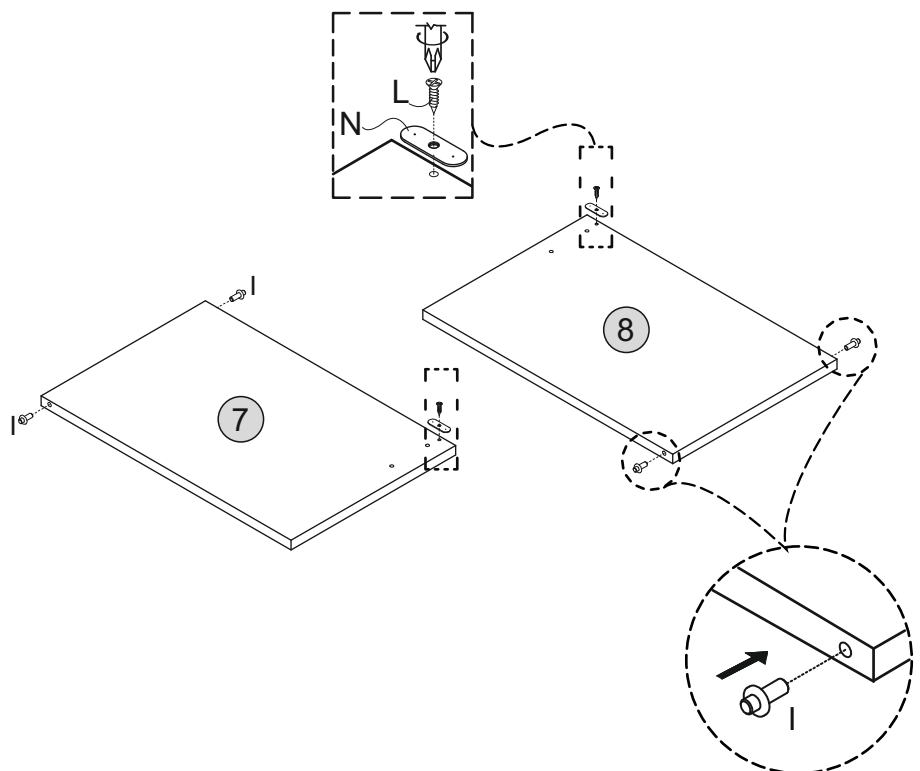
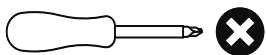

STEP 5

PARTS REQUIRED

- 1 - RIGHT SIDE PANEL x1
- 2 - LEFT SIDE PANEL x1
- 3 - RIGHT CENTRE PANEL x1
- 4 - TOP PANEL x1
- 6 - LEFT CENTRE PANEL x1

HARDWARE REQUIRED

TOOLS REQUIRED

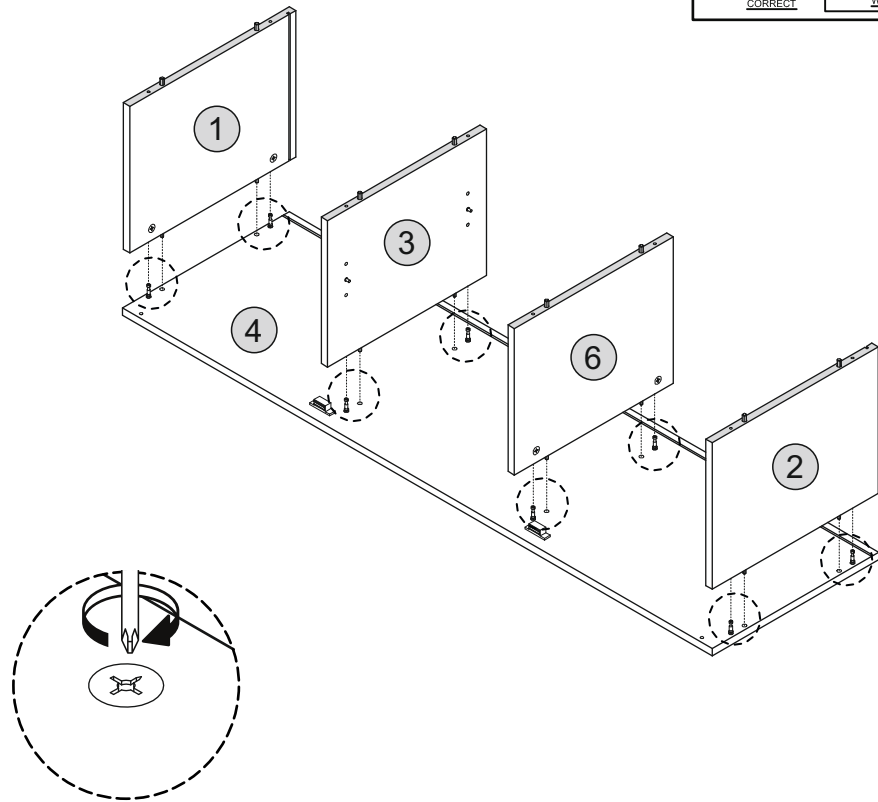
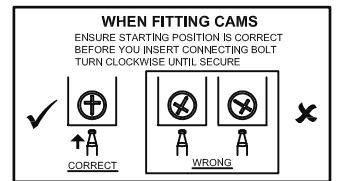
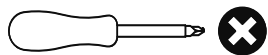

STEP 6

PARTS REQUIRED

- 10 - BACK PANEL x1

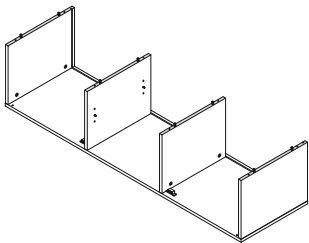

HARDWARE REQUIRED

TOOLS REQUIRED

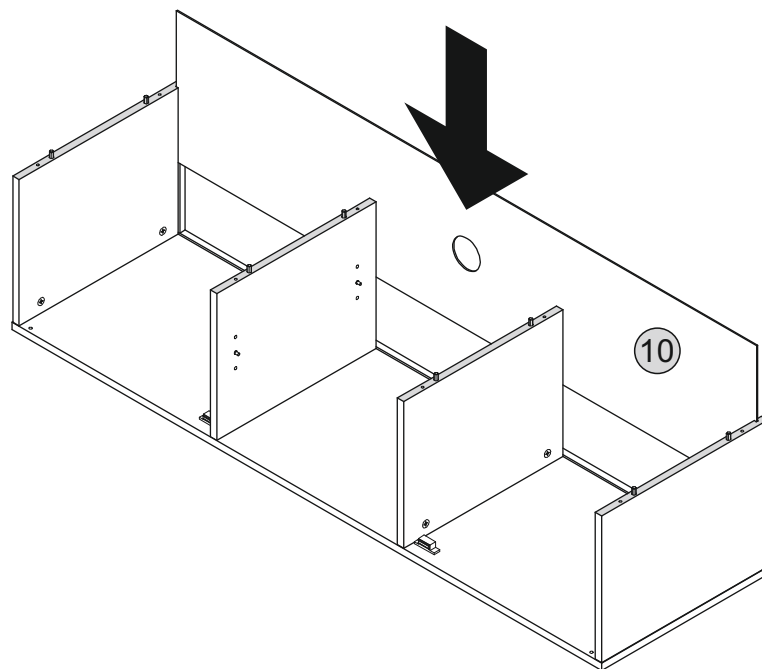

STEP 7

PARTS REQUIRED

7 - RIGHT DOOR x1

8 - LEFT DOOR x1

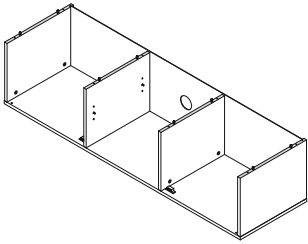

HARDWARE REQUIRED

G  04

H  02

TOOLS REQUIRED

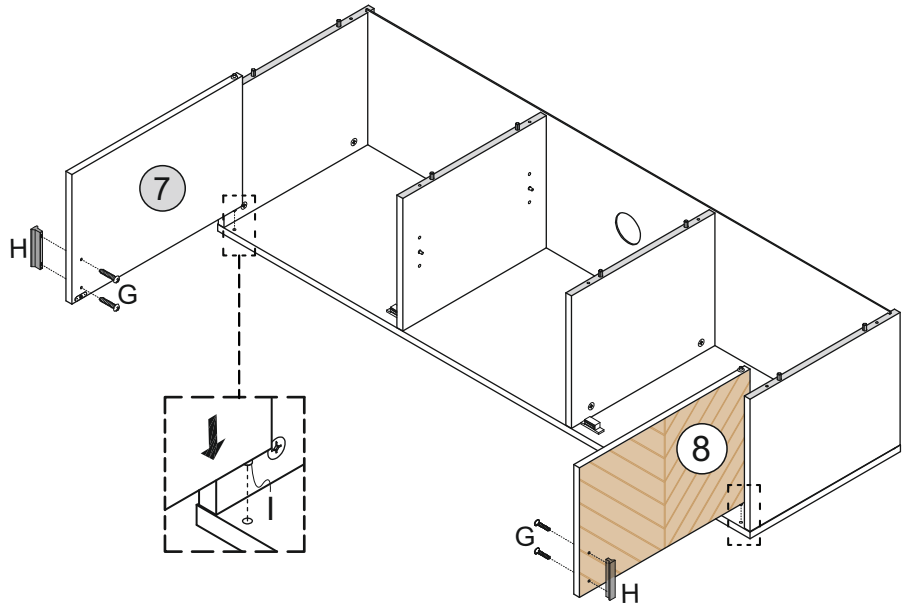
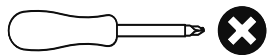

STEP 8

PARTS REQUIRED

9 - BOTTOM PANEL x1

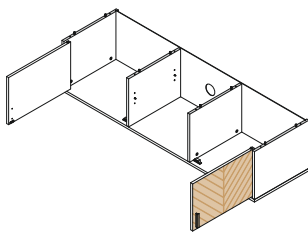

HARDWARE REQUIRED

E  4x45mm 08

TOOLS REQUIRED

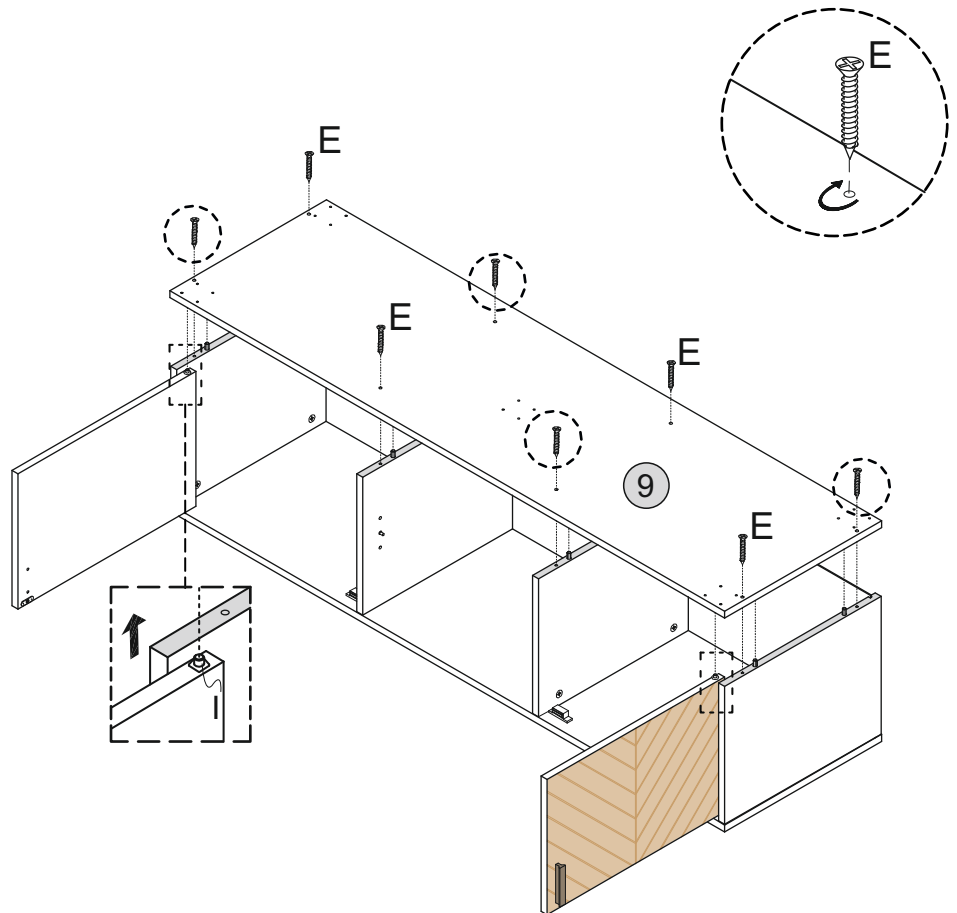
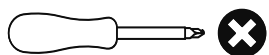

STEP 9

PARTS REQUIRED

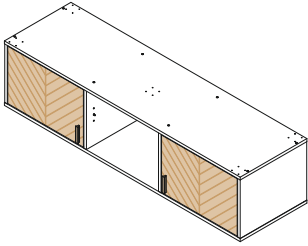

HARDWARE REQUIRED

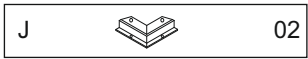

TOOLS REQUIRED

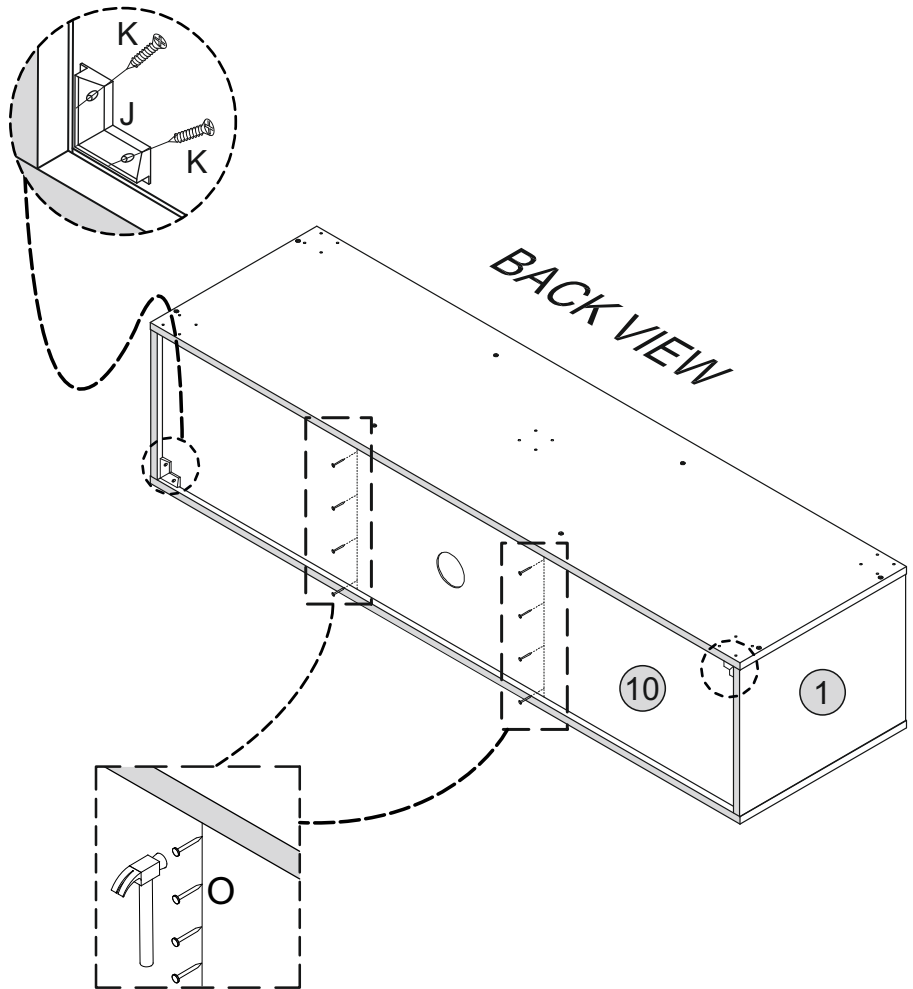
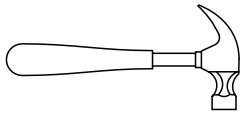
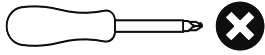

STEP 10

PARTS REQUIRED

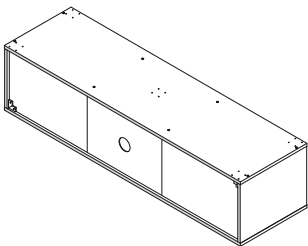

HARDWARE REQUIRED

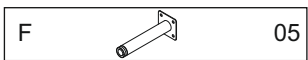
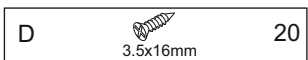

TOOLS REQUIRED

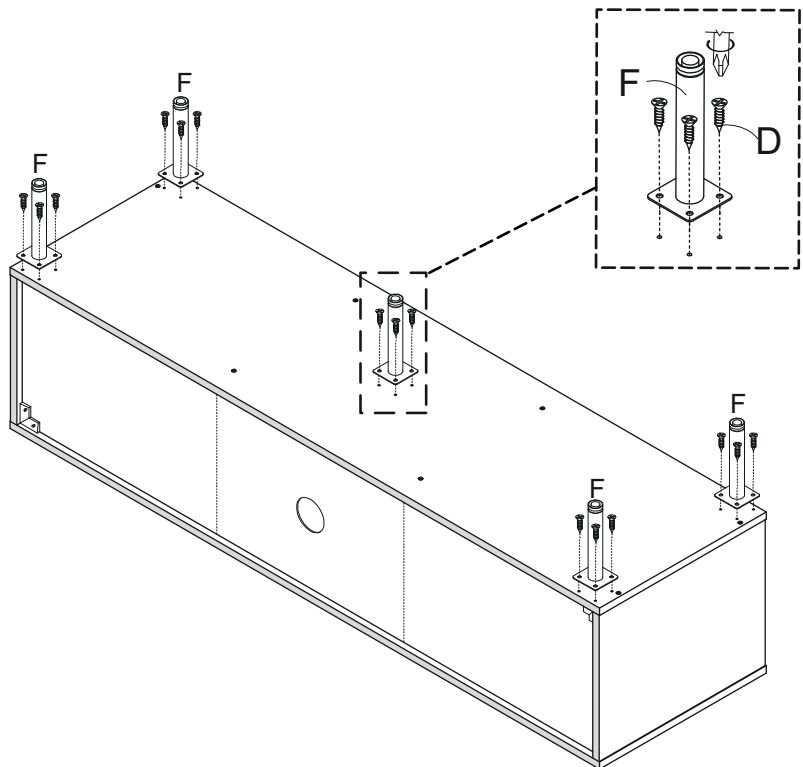
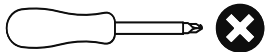

STEP 11

PARTS REQUIRED

5 - ADJUSTABLE SHELF PANEL x1

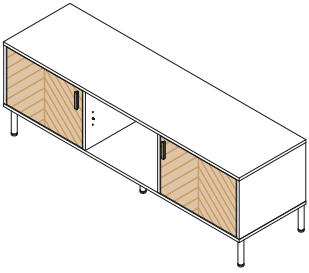

HARDWARE REQUIRED

TOOLS REQUIRED

