

CORONA TALL BOOKCASE ASSEMBLY INSTRUCTIONS

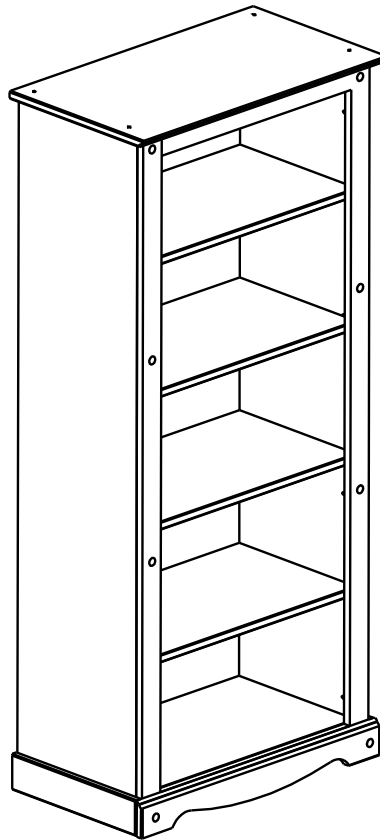

IMPORTANT PLEASE READ BEFORE YOU CONTINUE FURTHER **FOR DOMESTIC USE ONLY** **CARE AND MAINTENANCE**

After unpacking this product please keep the original packaging in case it needs to be returned for any reason.

- Please ensure all fittings and parts are present before commencing with assembly.
- We recommend that you lay a blanket or sheet on the floor to avoid damage to both your floor and the product.
- We strongly recommend that you keep children away from your work area.
- Assemble this product as close to its final position as possible.
- Never drag or push products as this could cause damage to the joints making it inferior.
- Do not place this product next to a radiator or in direct sunlight.
- Wood is a natural product and may expand if subjected to damp and may shrink or crack if subjected to heat. Therefore it is recommended that room temperature is maintained, with no sudden temperature fluctuations.
- Make sure any spillage is wiped off immediately.
- Do not place hot or chilled items directly on to the surface, use a place mat or marking will occur.
- For general cleaning use a duster, and do not use detergents of any kind. However, the surface will need to be retreated from time to time. This can be done by using block wax (unperfumed) and rubbing it over the whole item.
- From time to time it may be necessary to tighten fittings, regular inspections should be carried out.

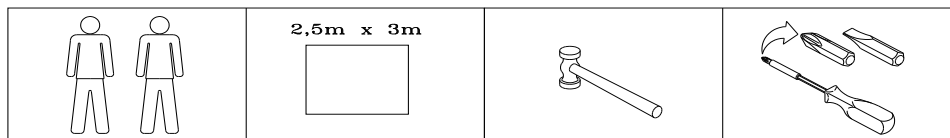
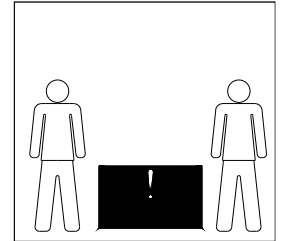
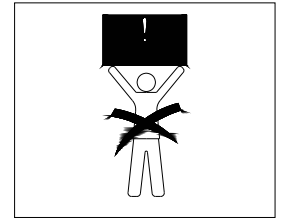
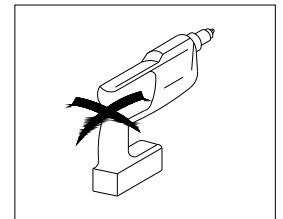
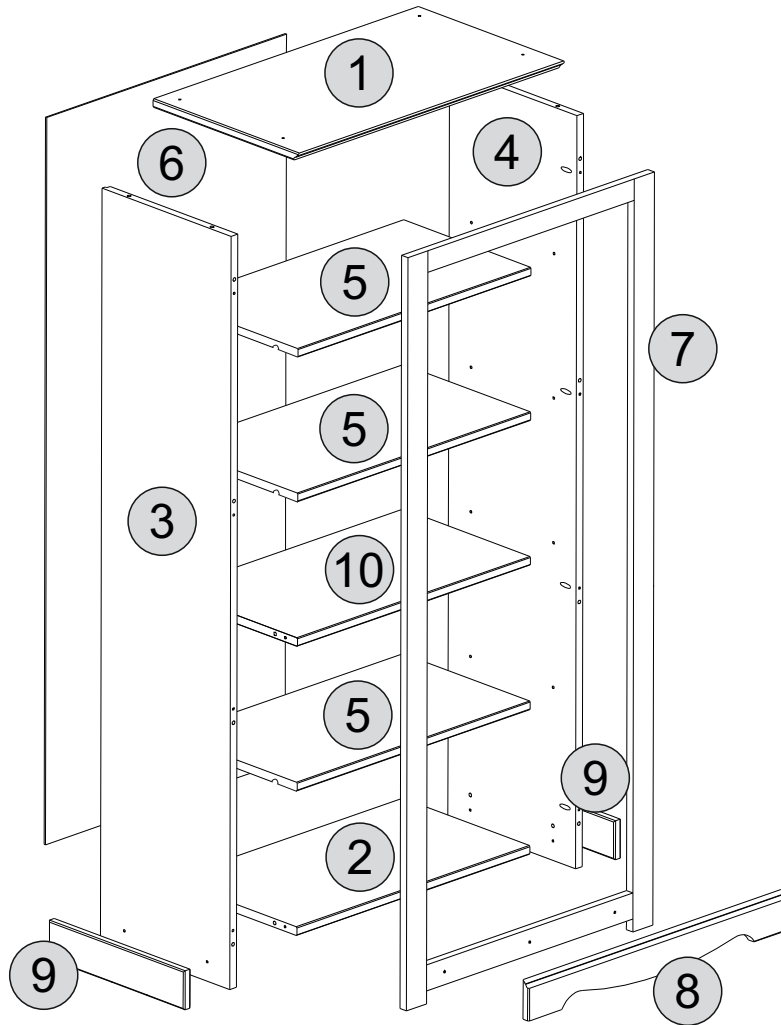

* Use of power tools to assemble this product will invalidate any claim and damage this product making it unsafe !!!
 * Please assemble on a clean soft surface to avoid damage.

* Please check contents and read the instructions before commencing assembly.
 * Assemble this product following the enclosed instructions carefully.
 * Please take care to avoid damaging panels during assembly.





PARTS LIST

Part Number	Part Code	Part Description	Quantity	Carton
1	S300-306-008-MY1-01	Top Panel	1	1/1
2	S300-306-008-MY1-02	Base	1	1/1
3	S300-306-008-MY1-03	Left Side Panel	1	1/1
4	S300-306-008-MY1-04	Right Side Panel	1	1/1
5	S300-306-008-MY1-05	Adjustable Shelf	3	1/1
6	S300-306-008-MY1-06	Back Panel	1	1/1
7	S300-306-008-MY1-07	Front Frame	1	1/1
8	S300-306-008-MY1-08	Front Plinth	1	1/1
9	S300-306-008-MY1-09	Side Plinth	2	1/1
10	S300-306-008-MY1-10	Fixed Shelf	1	1/1

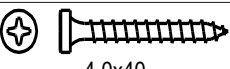
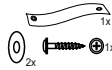

- * Please check contents and read the instructions before commencing assembly.
- * Assemble this product following the enclosed instructions carefully.
- * Please take care to avoid damaging parts during assembly.

FITTINGS



A	 $\varnothing 8 \times 30$	20	E		08
B	 $3,5 \times 30$	24	F	 10×10	40
C	 $4,0 \times 40$	04	G	 $1 \times$  $2 \times$	01
D		12			

STEP 1

PARTS REQUIRED

2 - BASE	x1
3 - LEFT SIDE PANEL	x1
4 - RIGHT SIDE PANEL	x1
10 - FIXED SHELF	x1

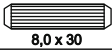
HARDWARE REQUIRED

A	 8,0 x 30	20
D		12

TOOLS REQUIRED

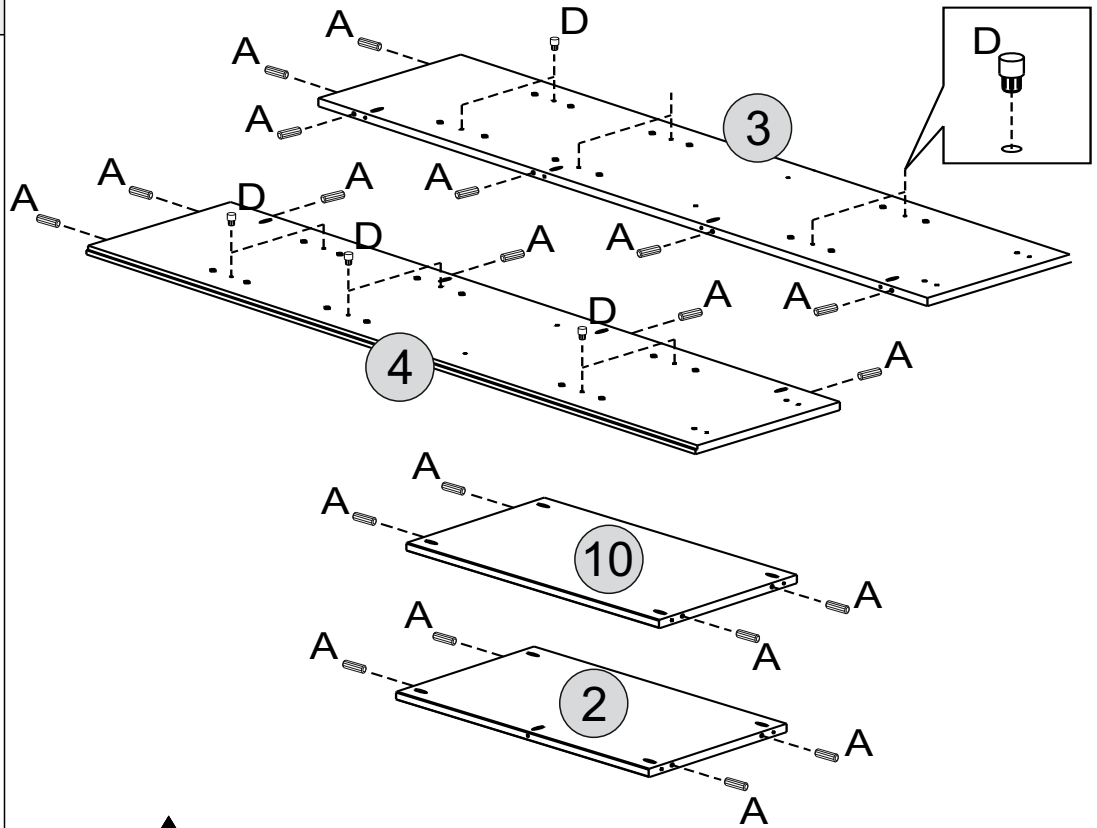

 Please assemble on a clean soft surface to avoid damage.

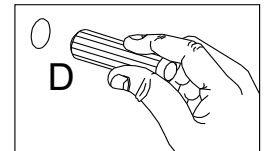

STEP 2

PARTS REQUIRED

2 - BASE	x1
4 - RIGHT SIDE PANEL	x1
10 - FIXED SHELF	x1

HARDWARE REQUIRED

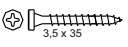
B	 3,5 x 35	04
---	--	----

TOOLS REQUIRED

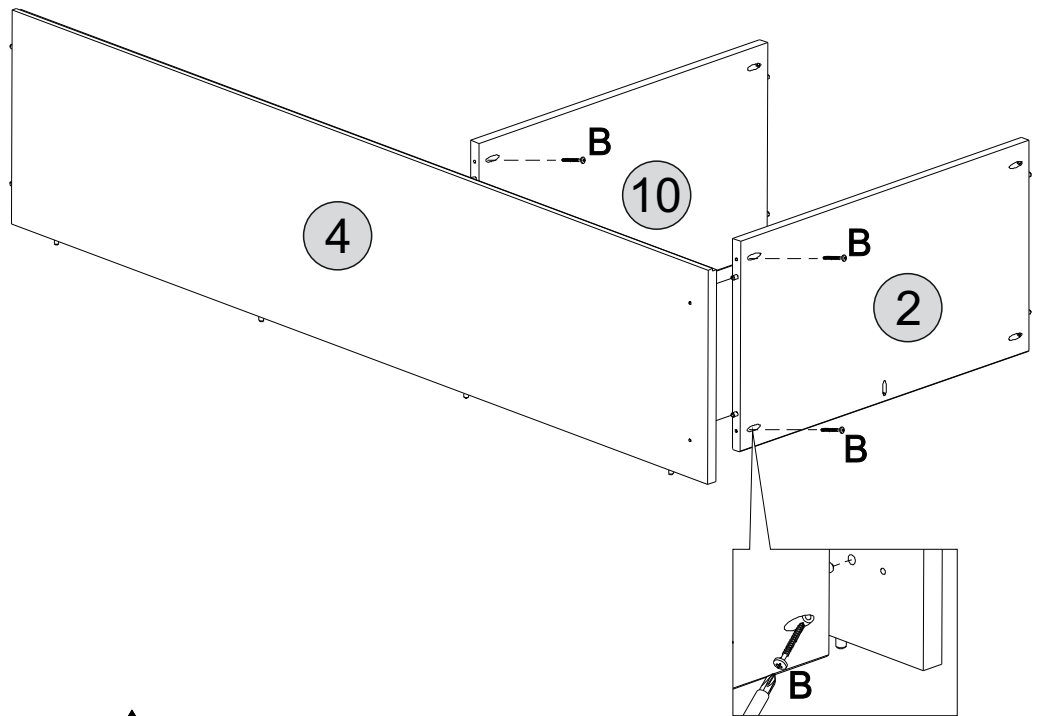
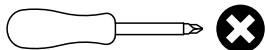

 Please assemble on a clean soft surface to avoid damage.

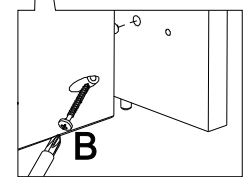

STEP 3

PARTS REQUIRED

- 1 - TOP PANEL x1
- 3 - LEFT SIDE PANEL x1

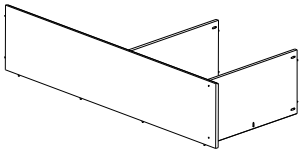

HARDWARE REQUIRED

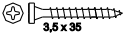
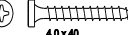
- B  04
- C  04

TOOLS REQUIRED

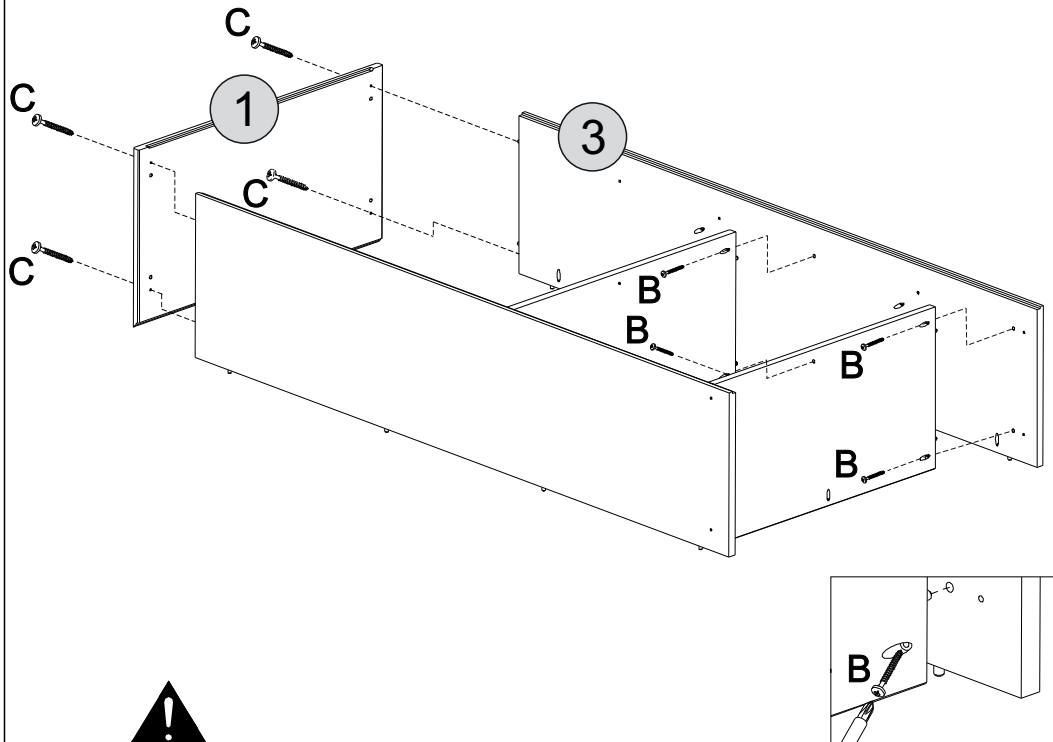
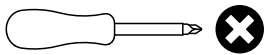

!
Please assemble on a clean soft surface to avoid damage.

STEP 4

PARTS REQUIRED

- 7 - FRONT FRAME x1

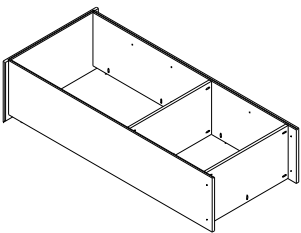

HARDWARE REQUIRED

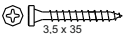
- B  09

TOOLS REQUIRED

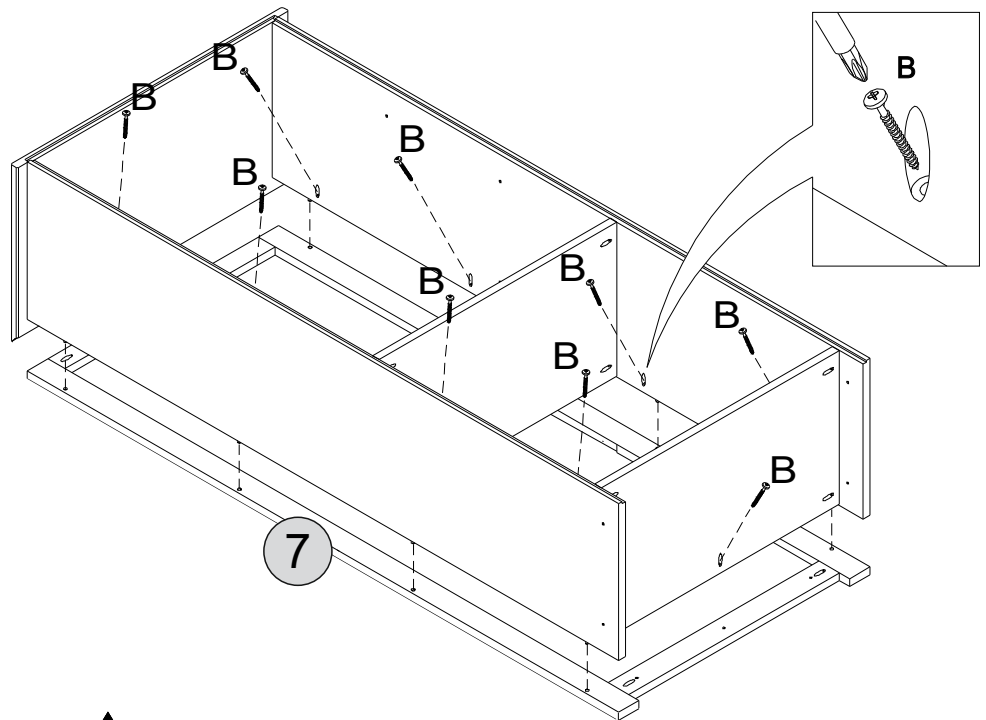
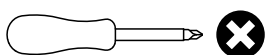

!
Please assemble on a clean soft surface to avoid damage.

STEP 5

PARTS REQUIRED

8 - FRONT PLINTH x1

9 - SIDE PLINTH x2

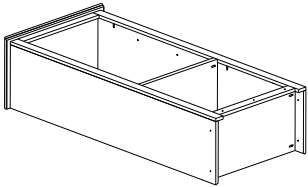

HARDWARE REQUIRED

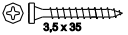
B  07
3,5 x 35

TOOLS REQUIRED

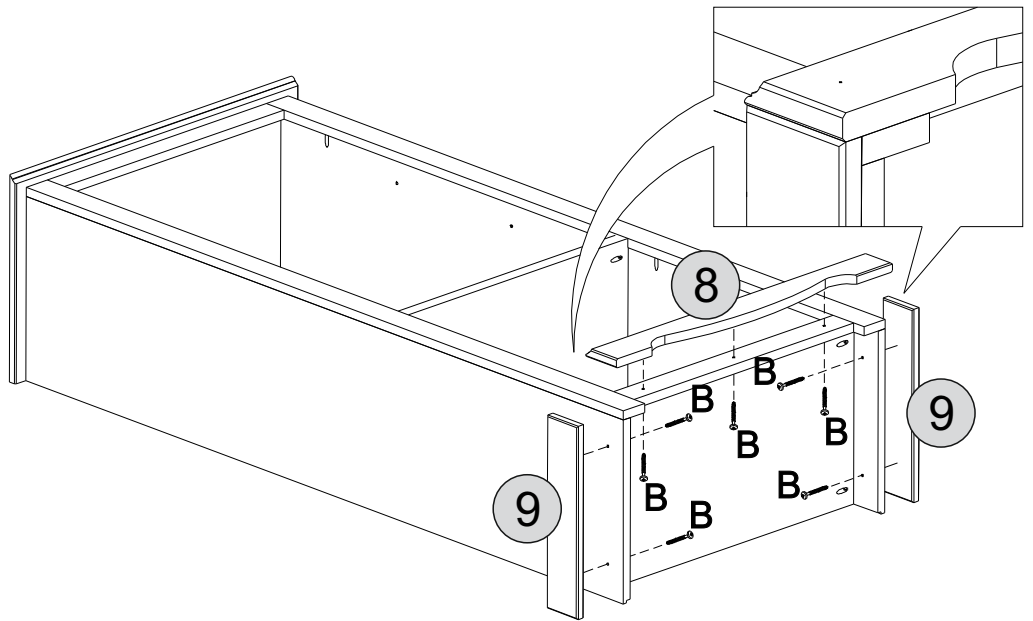
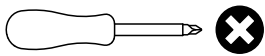

 Please assemble on a clean soft surface to avoid damage.

STEP 6

PARTS REQUIRED

6 - BACK PANEL x1

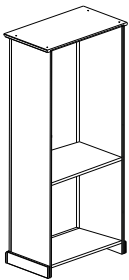

HARDWARE REQUIRED

F  26
10x10

TOOLS REQUIRED

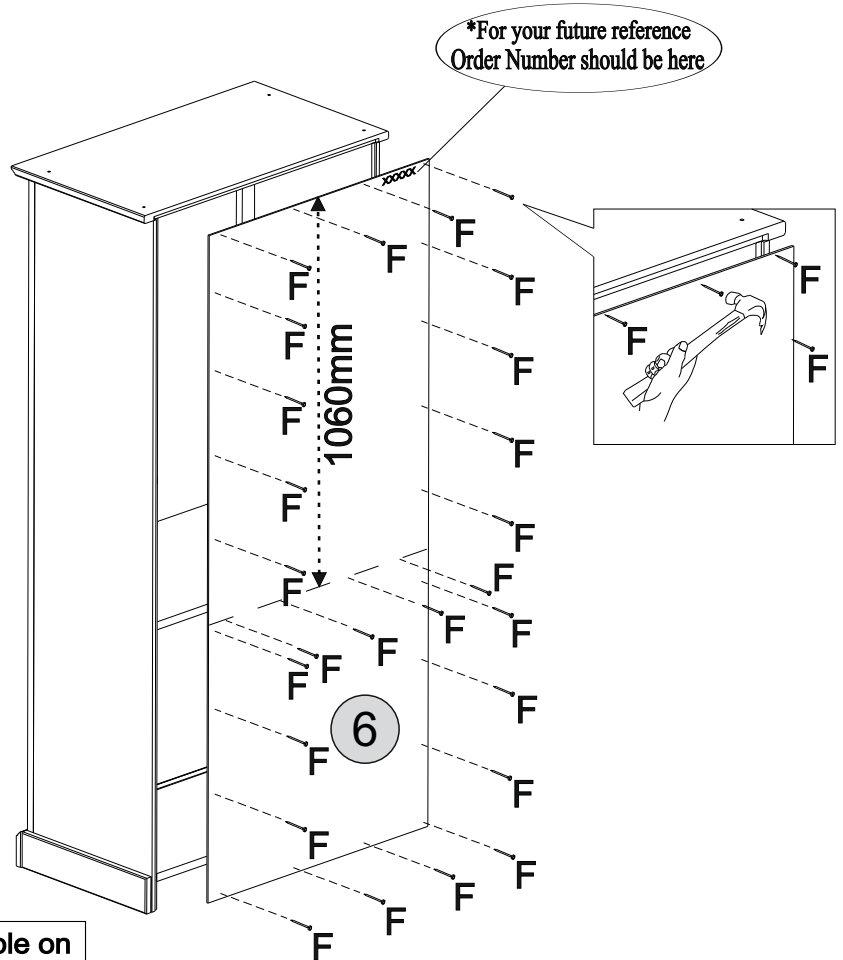
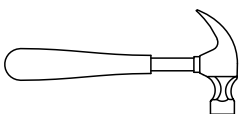

 Please assemble on a clean soft surface to avoid damage.

STEP 7

PARTS REQUIRED

5 - ADJUSTABLE SHELF x3

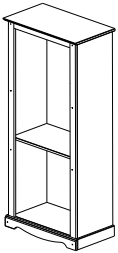

HARDWARE REQUIRED

E  08

TOOLS REQUIRED

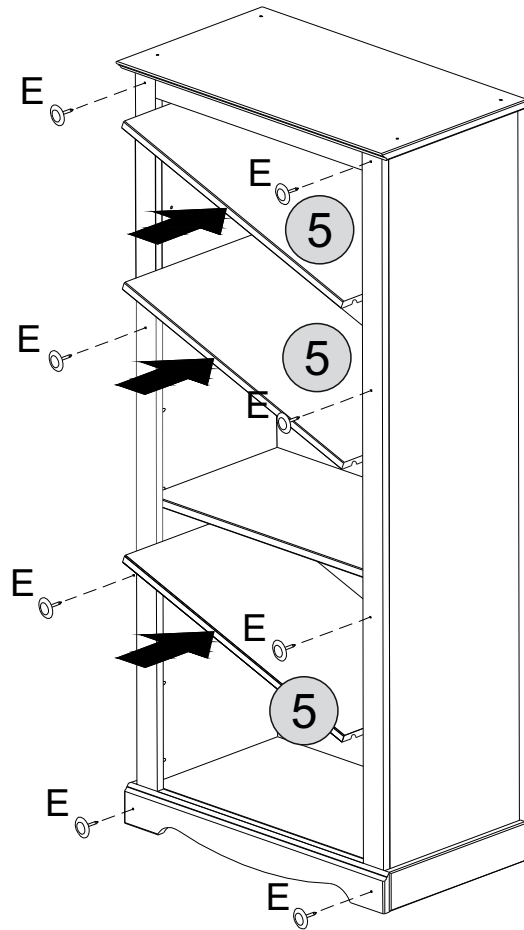
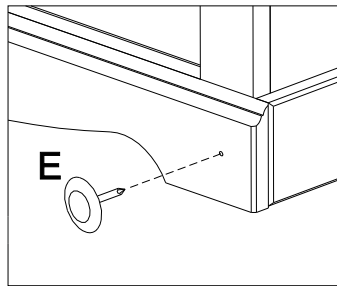
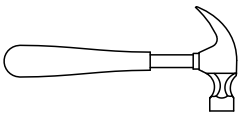

 Please assemble on a clean soft surface to avoid damage.

STEP 8

PARTS REQUIRED

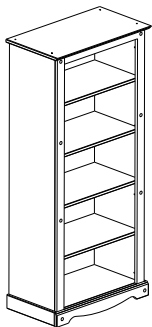

HARDWARE REQUIRED

G  01

TOOLS REQUIRED

WARNING

Serious or fatal injuries can occur from furniture tipping over. To prevent the furniture from tipping over we recommend that it is permanently fixed to the wall.

Wall fixings are not supplied with this product as different wall materials require different types of fixing devices. Please make sure you use fixings suitable for the walls in your home.

