

OAK EFFECT NAPLES MEDIUM BOOKCASE ASSEMBLY INSTRUCTIONS

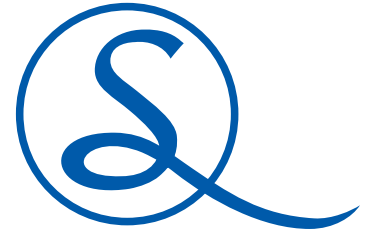
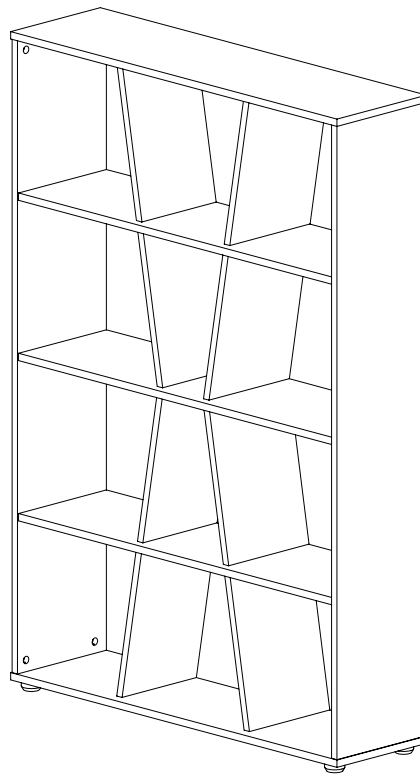

IMPORTANT FOR DOMESTIC USE ONLY

PLEASE READ BEFORE YOU CONTINUE FURTHER

CARE AND MAINTENANCE

After unpacking this product please keep the original packaging in case it needs to be returned for any reason.

- Please ensure all fittings and parts are present before commencing with assembly.
- Never drag or push products as this could cause damage to the joints making it inferior.
- We strongly recommend that you keep children away from your work area.
- We recommend that you lay a blanket or sheet on the floor to avoid damage to both your floor and the product.
- Assemble this product as close to its final position as possible.
- Do not place this product next to a radiator or in direct sunlight.
- Do not drag or push items across your high gloss furniture as this may cause the surface to scratch
- Wood is a natural product and may expand if subjected to damp and may shrink or crack if subjected to heat. Therefore it is recommended that room temperature is maintained, with no sudden temperature fluctuations.
- Make sure any spillage is wiped off immediately.
- Do not place hot or chilled items directly on to the surface, use a place mat or marking will occur.
- For general cleaning use a soft cotton or micro fibre cloth, and do not use detergents of any kind.
- From time to time it may be necessary to tighten fittings, regular inspections should be carried out.
- Do not place on a wet or damp floor as staining may occur to your floor.

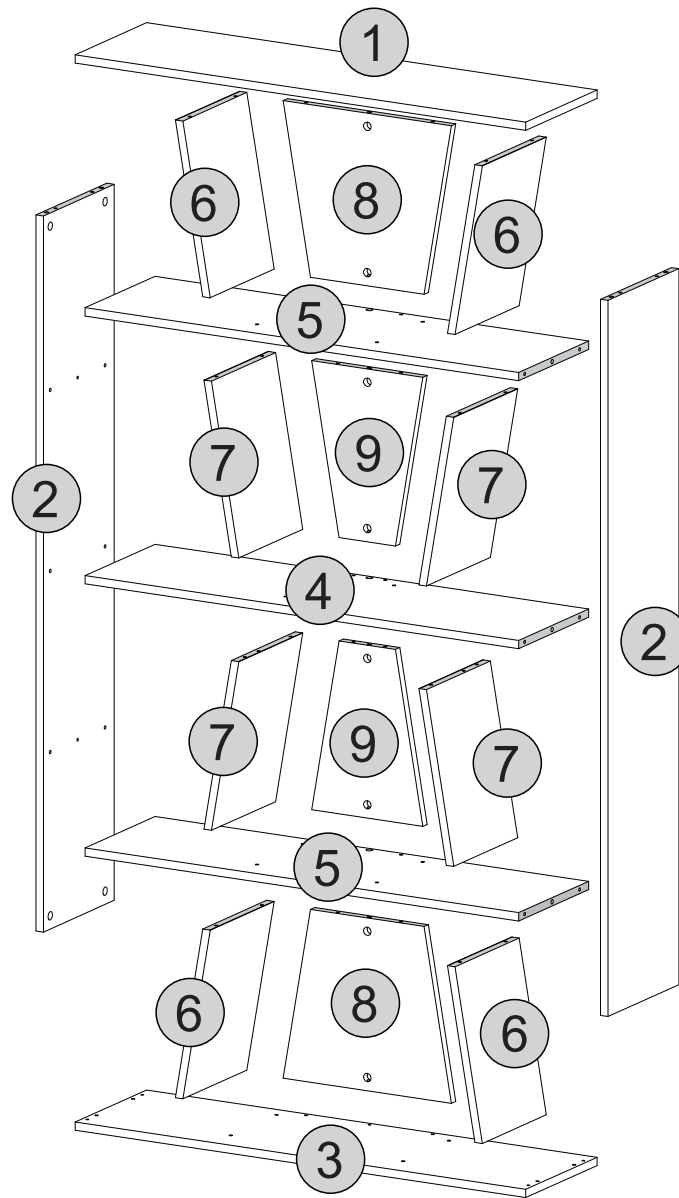

TOOLS REQUIRED

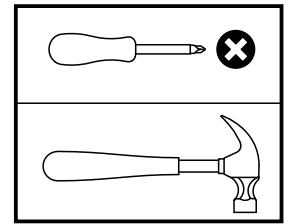





PARTS LIST

Please Note:

The below parts have all been stamped with the part number to help identify them during assembly.

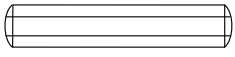
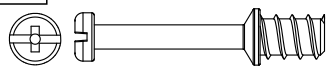
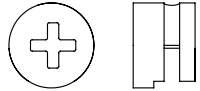
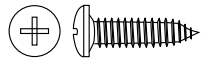
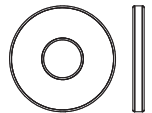
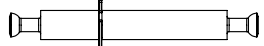
Part Number	Part Code	Part Description	Quantity	Carton
1	S300-306-046-AY1-01	Top Panel	1	1/1
2	S300-306-046-AY1-02	Side Panel	2	1/1
3	S300-306-046-AY1-03	Base Panel	1	1/1
4	S300-306-046-AY1-04	Centre Shelf Panel	1	1/1
5	S300-306-046-AY1-05	Outer Shelf Panel	2	1/1
6	S300-306-046-AY1-06	Outer Partition	4	1/1
7	S300-306-046-AY1-07	Centre Partition	4	1/1
8	S300-306-046-AY1-08	Large Back Panel	2	1/1
9	S300-306-046-AY1-09	Small Back Panel	2	1/1

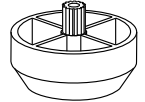
FITTINGS LIST

<p>A</p>  <p>2/+ Dowel Ø6,0 x 30mm (68x)</p>	<p>B</p>  <p>2/+ Cam Bolt (16x)</p>	<p>C</p>  <p>2/+ Cam Nut (22x)</p>	<p>D</p>  <p>1/+ FlatHead Screw Ø4 x 14mm (1x)</p>
<p>E</p>  <p>1/+ Washer (2x)</p>	<p>F</p>  <p>1/+ Double Rod Minifix (3x)</p>	<p>G</p>  <p>Glue (2x)</p>	<p>H</p>  <p>Plastic Foot 40x18mm (6x)</p>
<p>I</p>  <p>Strap (1x)</p>	<p>J</p>  <p>2/+ Hole Plugs (16x)</p>		

TIPS FOR FITTINGS CAM-LOCKS

WHEN FITTING CAM NUT. ENSURE STARTING POSITION IS CORRECT BEFORE YOU INSERT CONNECTING CAM BOLT TURN CLOCKWISE UNTIL SECURE

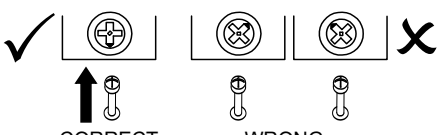

CORRECT **WRONG**

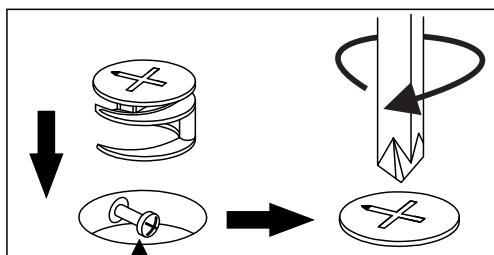

Cam bolt head needs to be in centre

CAMBOLT

Tighten until shoulder in flush with panel. Do not overtighten or undertighten (see example below)

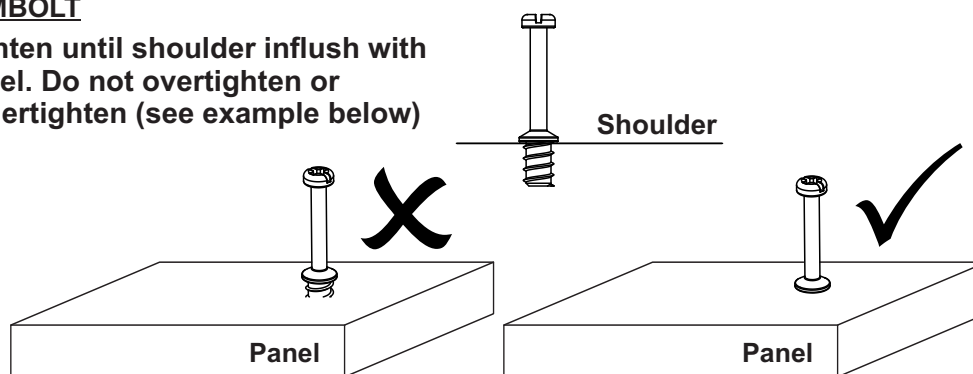

STEP 1

PARTS REQUIRED

1 - TOP PANEL x1

HARDWARE REQUIRED

B  05

TOOLS REQUIRED

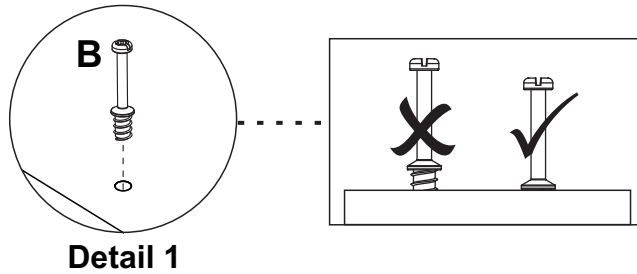
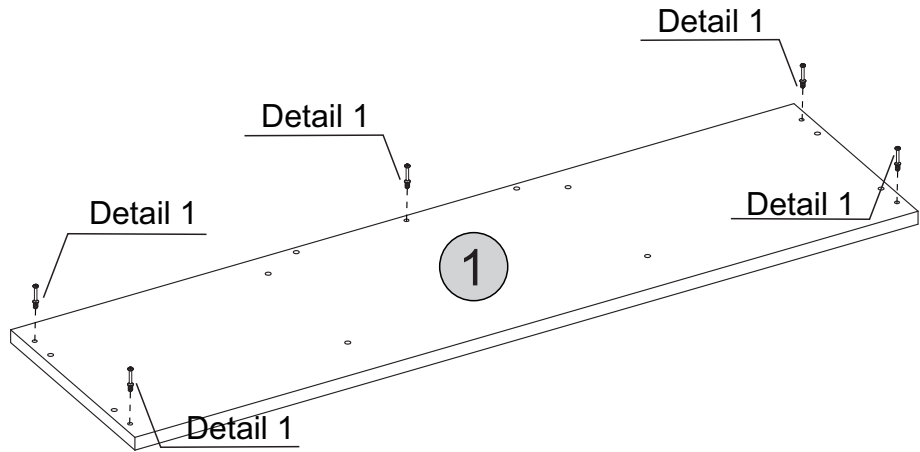
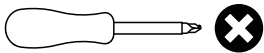

STEP 2

PARTS REQUIRED

3 - BASE PANEL x1

HARDWARE REQUIRED

B  05

H  06

TOOLS REQUIRED

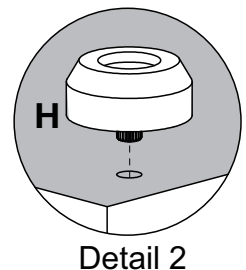
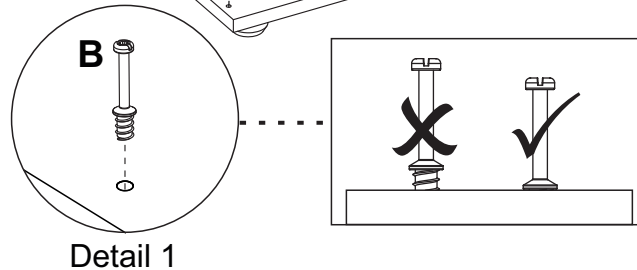
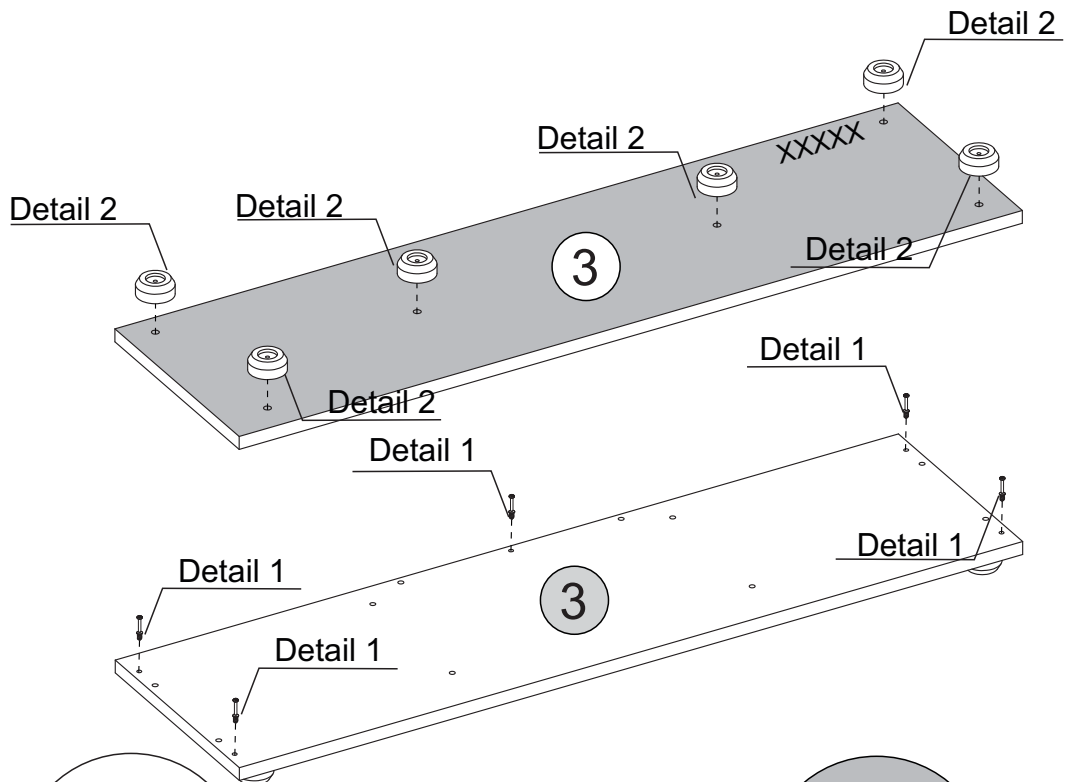
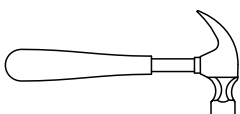
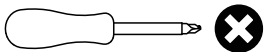

STEP 3

PARTS REQUIRED

4 - CENTRE SHELF PANEL x1

HARDWARE REQUIRED

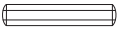
A  04

G  01

TOOLS REQUIRED

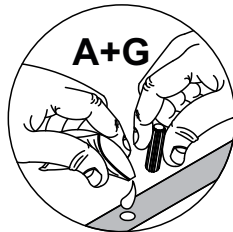
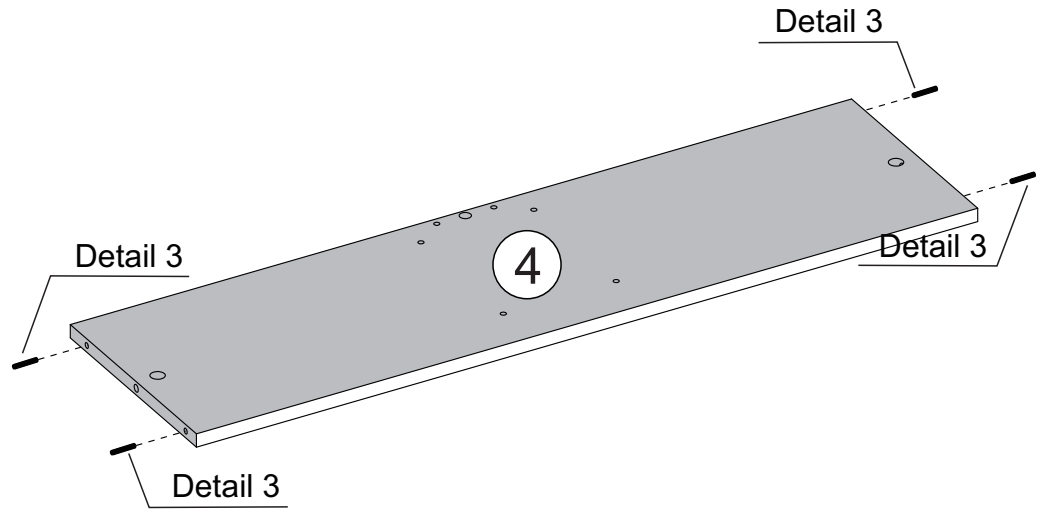
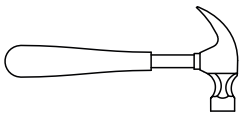

Detail 3

STEP 4

PARTS REQUIRED

5 - OUTER SHELF PANEL x2

HARDWARE REQUIRED

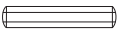
A  08

G  01

TOOLS REQUIRED

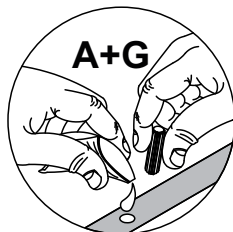
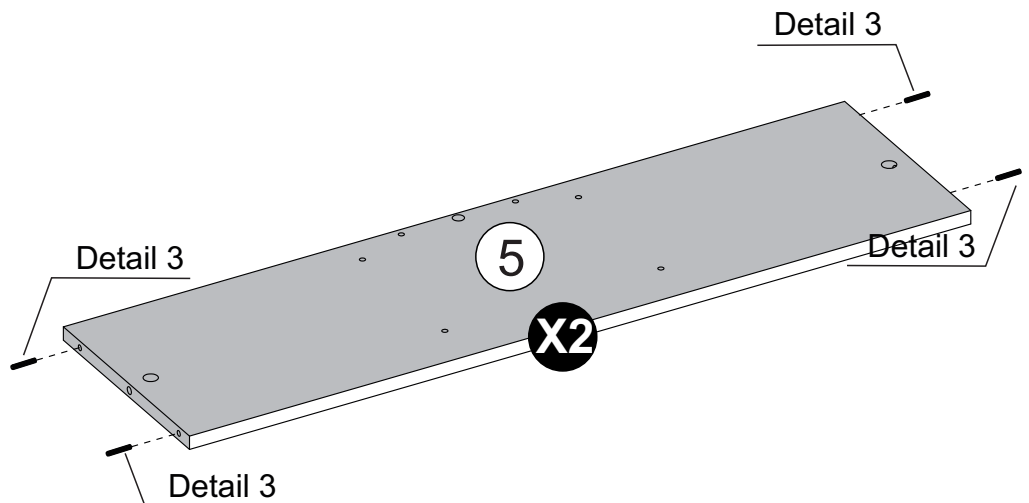
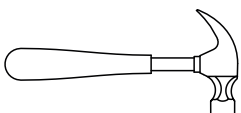

Detail 3

STEP 5

PARTS REQUIRED

2 - SIDE PANEL x2

HARDWARE REQUIRED

A  08

B  06

G  01

TOOLS REQUIRED

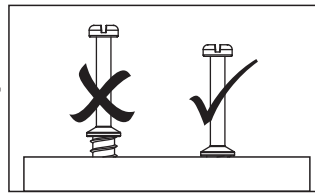
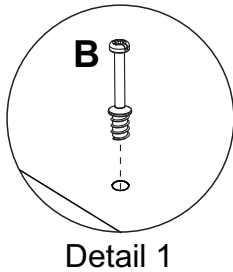
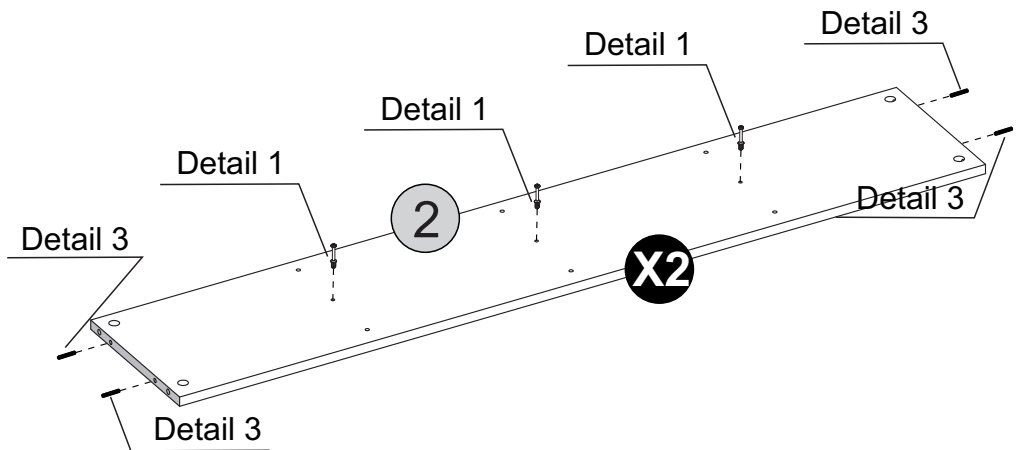
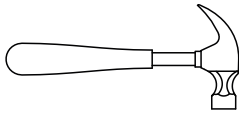
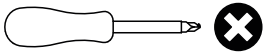

STEP 6

PARTS REQUIRED

6 - OUTER PARTITION x4

HARDWARE REQUIRED

A  16

G  01

TOOLS REQUIRED

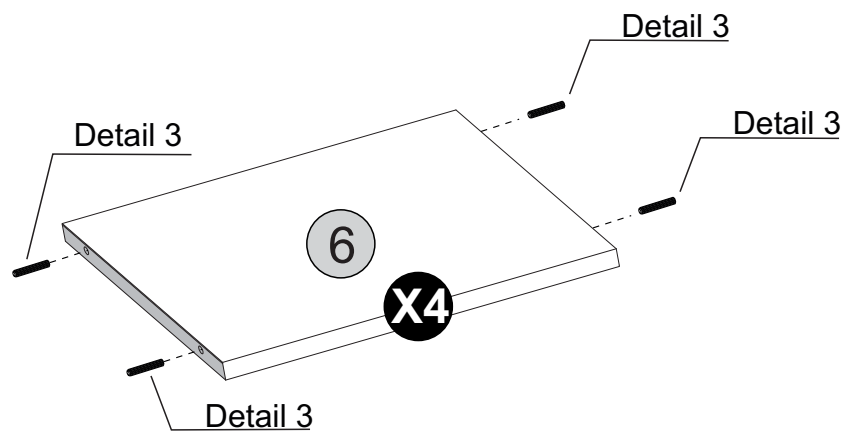
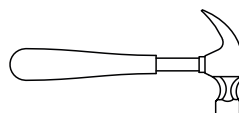

STEP 7

PARTS REQUIRED

7 - CENTRE PARTITION x4

HARDWARE REQUIRED

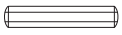
A  16

G  01

TOOLS REQUIRED

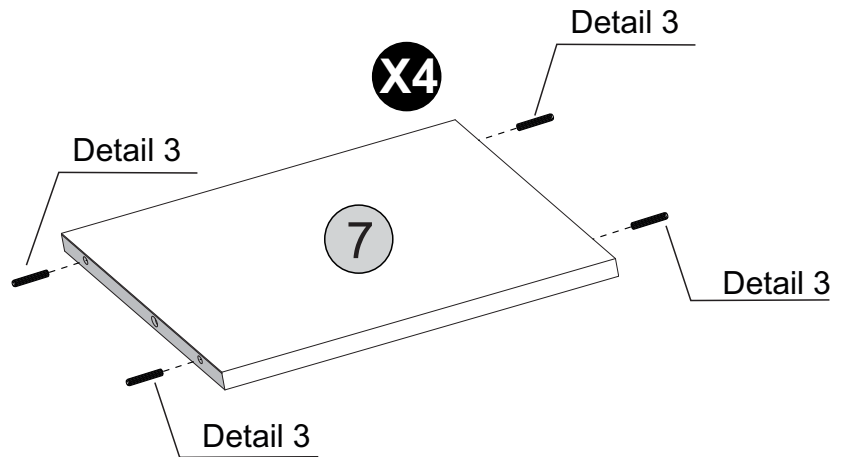
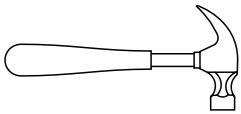

Detail 3

STEP 8

PARTS REQUIRED

8 - LARGE BACK PANEL x2

HARDWARE REQUIRED

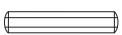
A  08

G  01

TOOLS REQUIRED

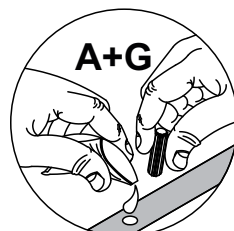
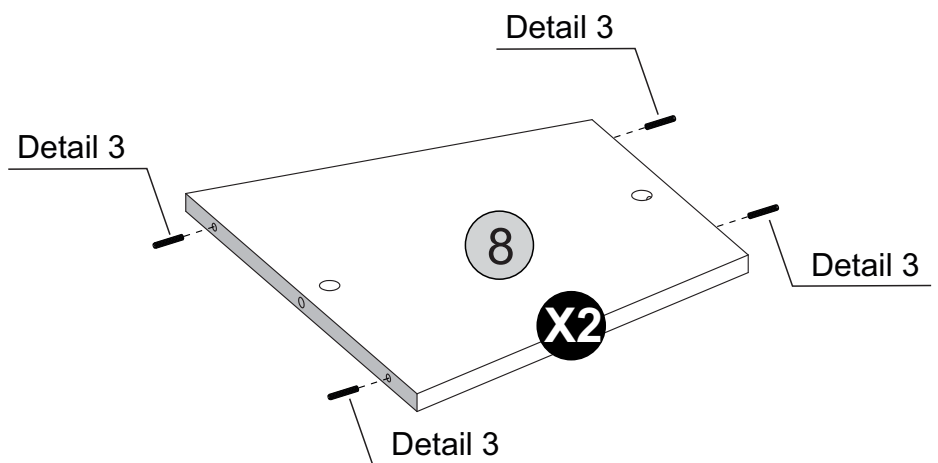
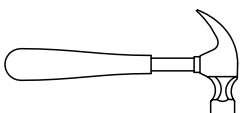

Detail 3

STEP 9

PARTS REQUIRED

9 - SMALL BACK PANEL x2

HARDWARE REQUIRED

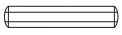
A  08

G  01

TOOLS REQUIRED

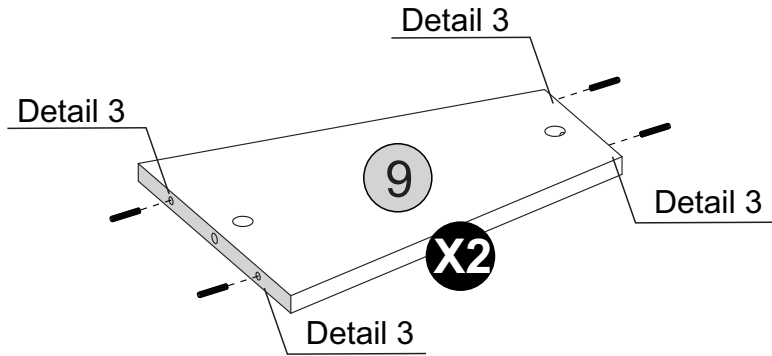
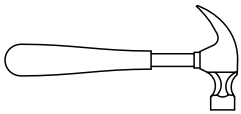

Detail 3

STEP 10

PARTS REQUIRED

1 - TOP PANEL x1

2 - SIDE PANEL x1

HARDWARE REQUIRED

C  02

G  01

TOOLS REQUIRED

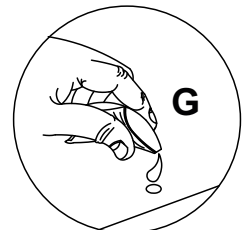
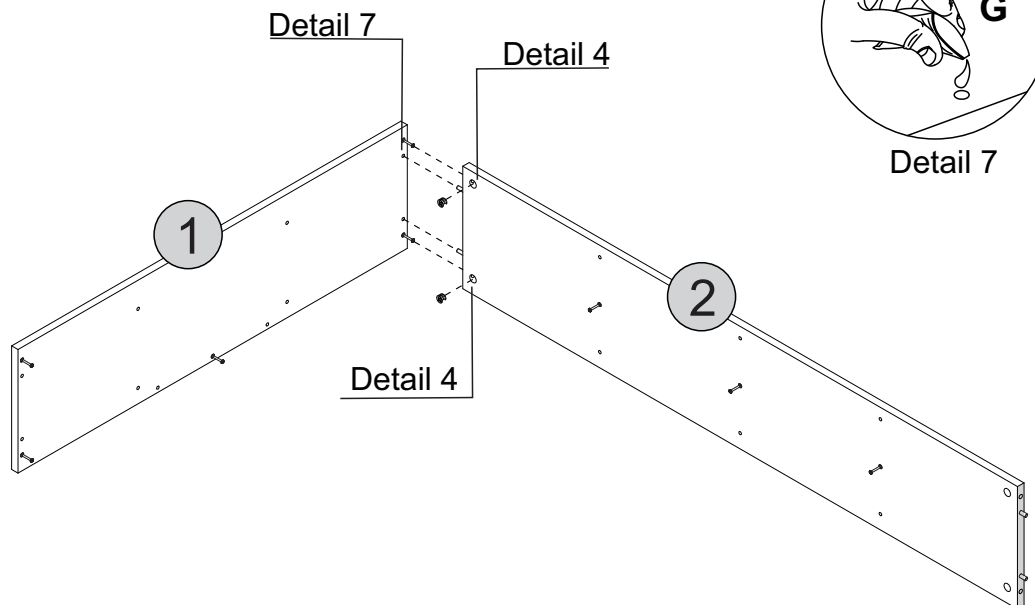
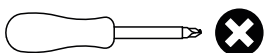

Detail 7

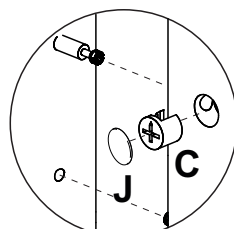

Detail 4

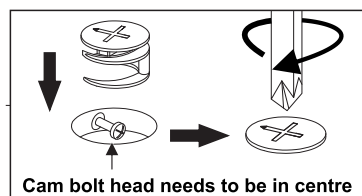

STEP 11

PARTS REQUIRED

8 - LARGE BACK PANEL x1

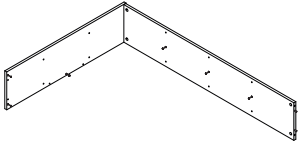

HARDWARE REQUIRED

C  01

G  01

J  01

TOOLS REQUIRED

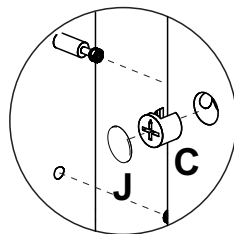
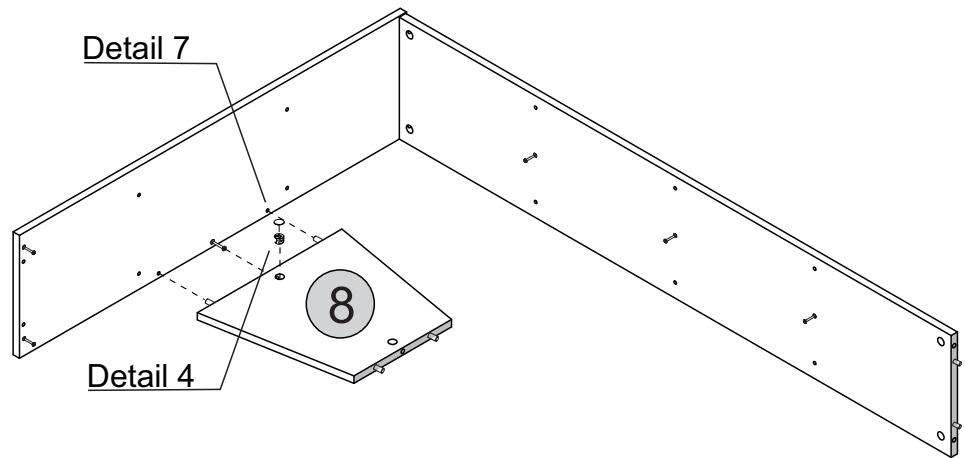
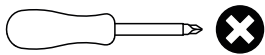

Detail 4

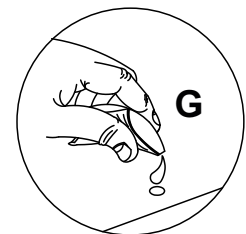
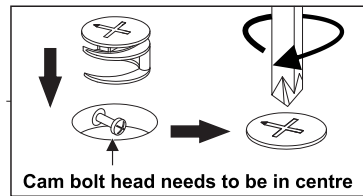

Detail 7

STEP 12

PARTS REQUIRED

6 - OUTER PARTITION x2

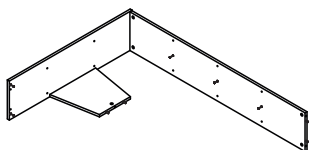

HARDWARE REQUIRED

TOOLS REQUIRED

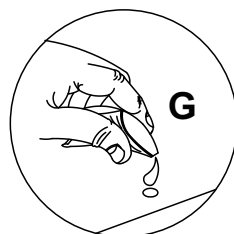
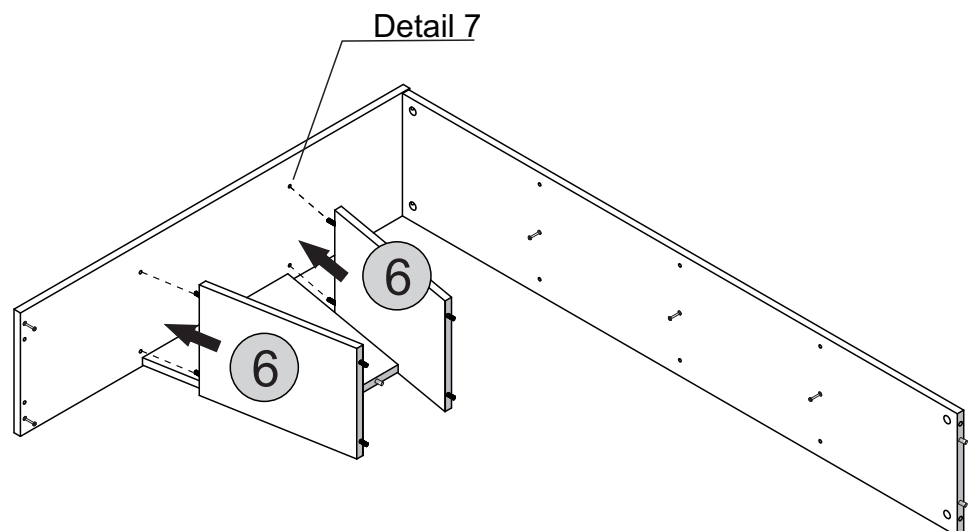

Detail 7

STEP 13

PARTS REQUIRED

5 - OUTER SHELF PANEL x2

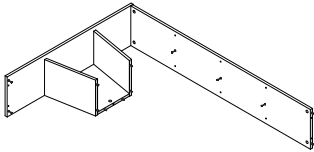

HARDWARE REQUIRED

C 02

F 01

G 01

J 01

TOOLS REQUIRED

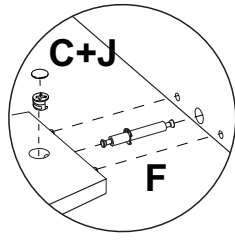
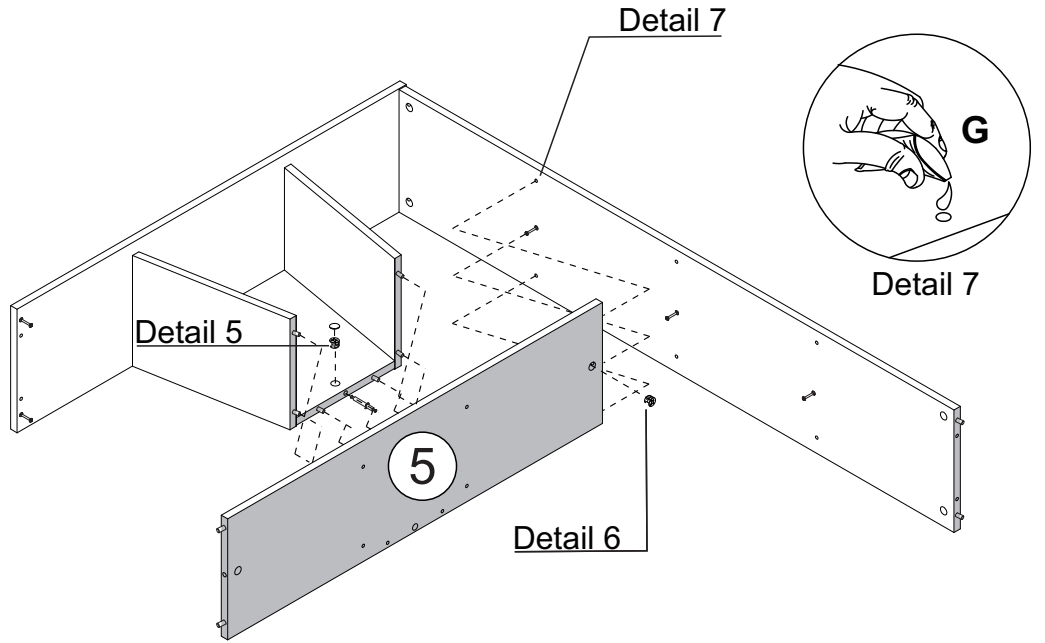
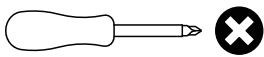

Detail 5

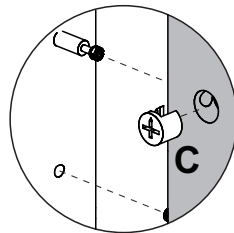

Detail 6

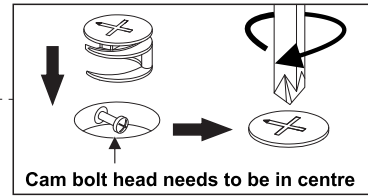

STEP 14

PARTS REQUIRED

9 - SMALL BACK PANEL x1

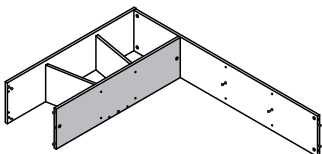

HARDWARE REQUIRED

C 01

G 01

J 01

TOOLS REQUIRED

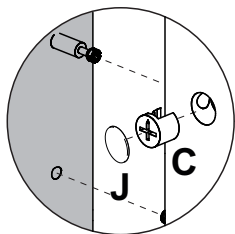
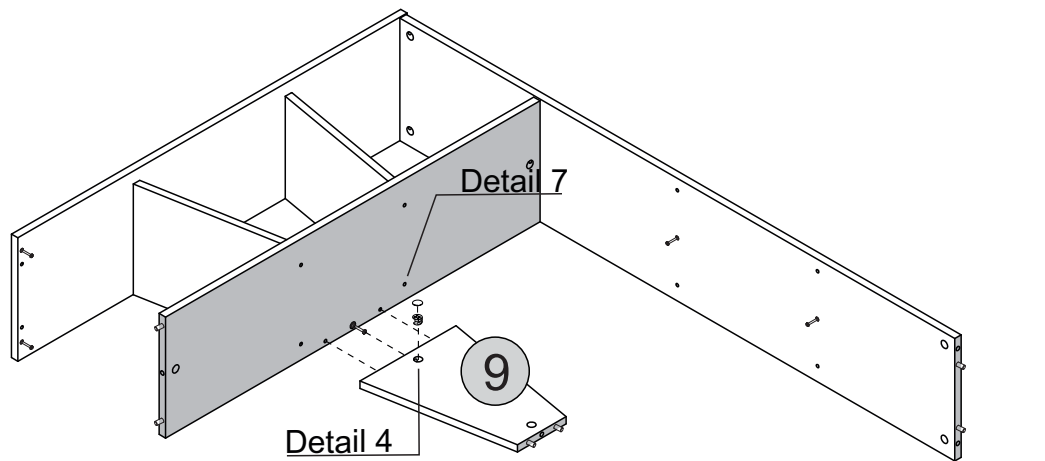
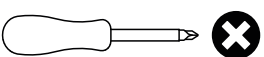

Detail 4

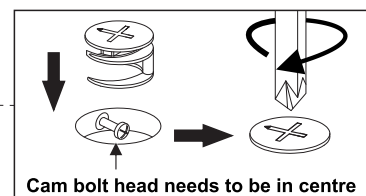

Detail 7

STEP 15

PARTS REQUIRED

7 - CENTRE PARTITION x2

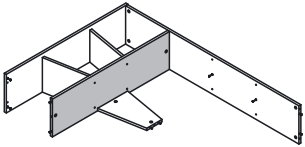

HARDWARE REQUIRED

G  01

TOOLS REQUIRED

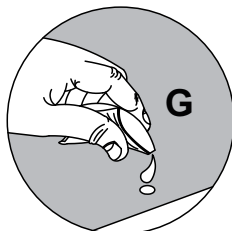
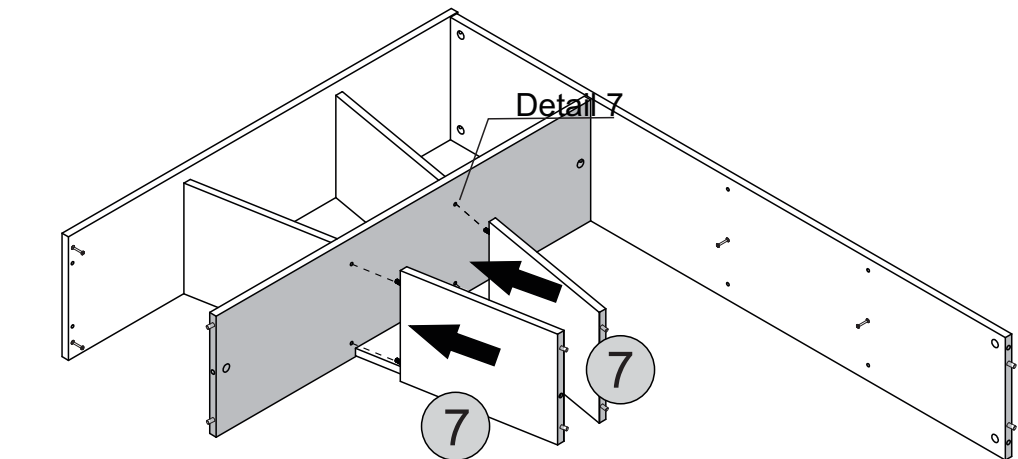

Detail 7

STEP 16

PARTS REQUIRED

4 - CENTRE SHELF PANEL x1

HARDWARE REQUIRED

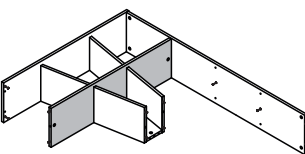

HARDWARE REQUIRED

C  02

F  01

G  01

J  01

TOOLS REQUIRED

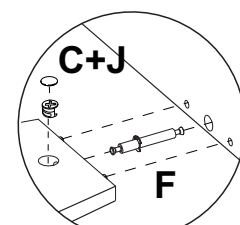
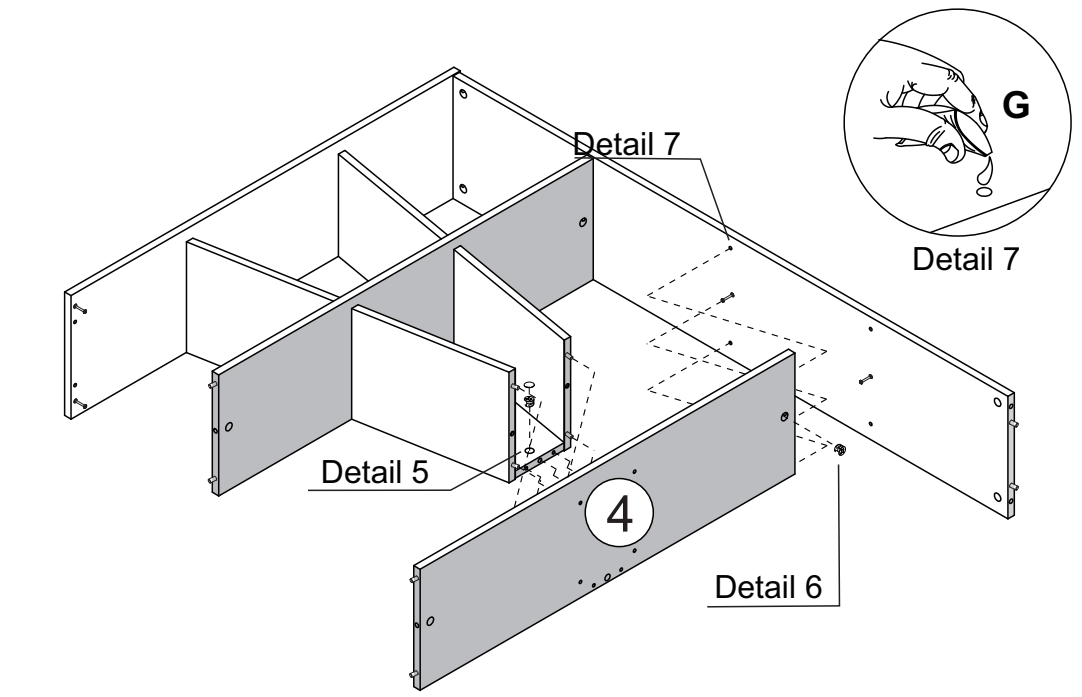
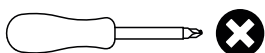

Detail 5

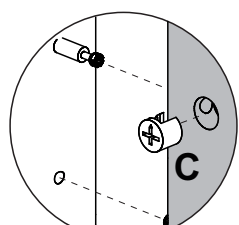

Detail 6

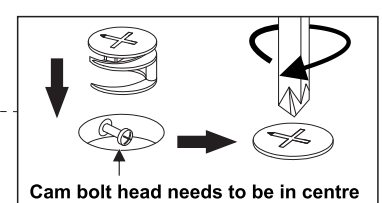

STEP 17

PARTS REQUIRED

9 - SMALL BACK PANEL x1

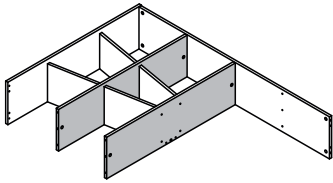

HARDWARE REQUIRED

C  01

G  01

TOOLS REQUIRED

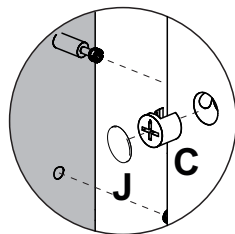
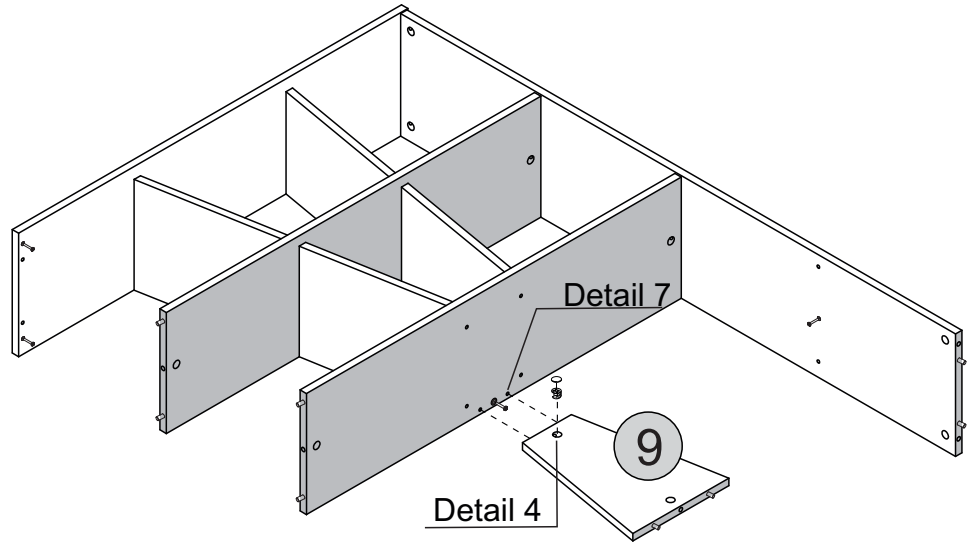
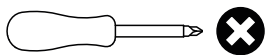

Detail 4

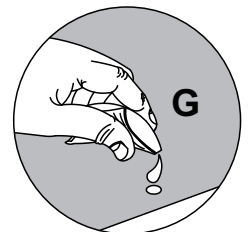
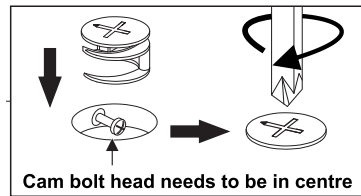

Detail 7

STEP 18

PARTS REQUIRED

7 - CENTRE PARTITION x2

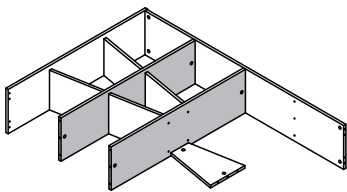

HARDWARE REQUIRED

G  01

TOOLS REQUIRED

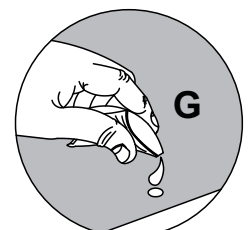
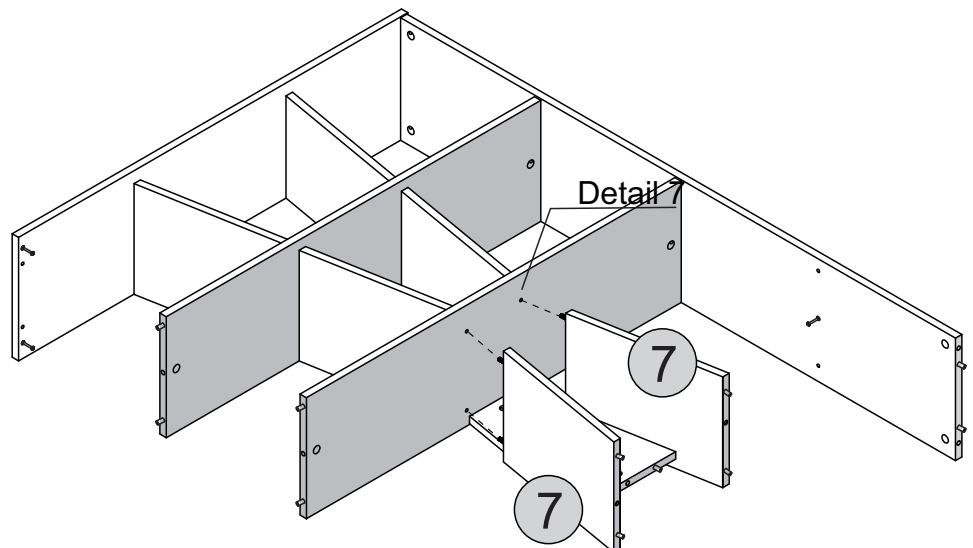

Detail 7

STEP 19

PARTS REQUIRED

5 - OUTER SHELF PANEL x1

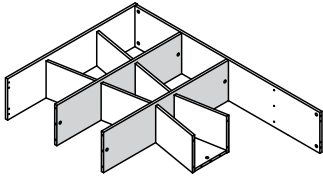

HARDWARE REQUIRED

C  02

F  01

G  01

J  02

TOOLS REQUIRED

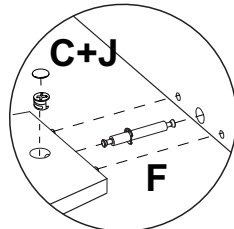
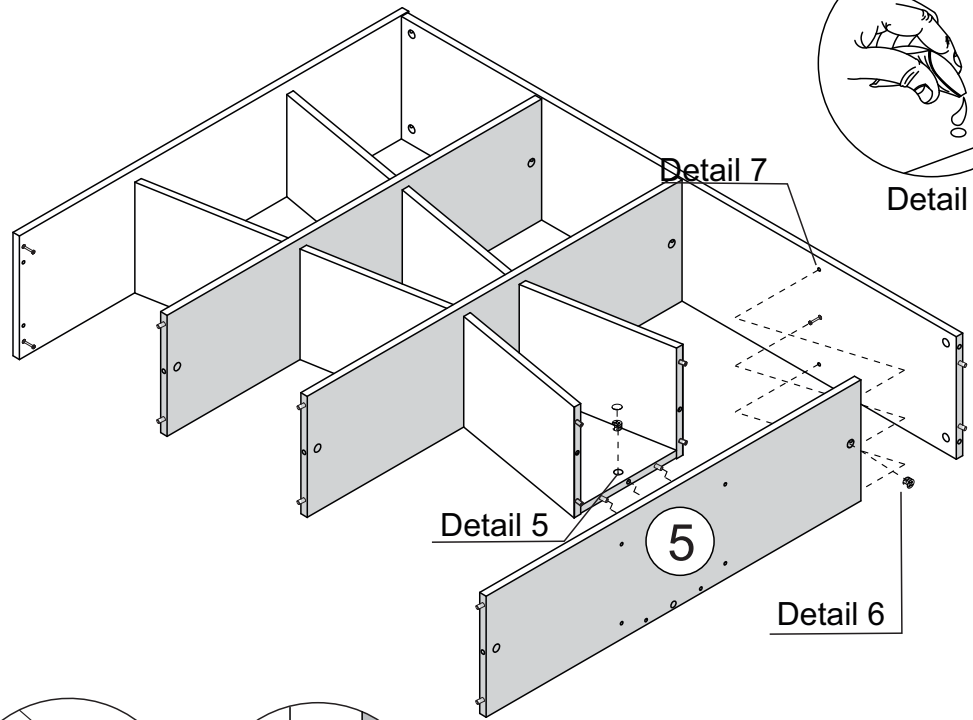
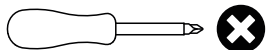

Detail 5

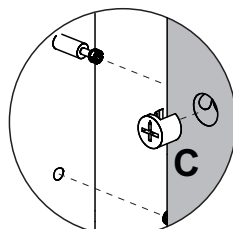

Detail 6

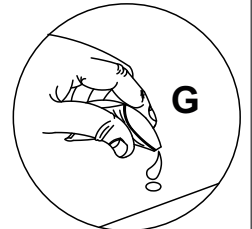
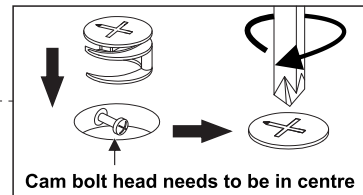

Detail 7

STEP 20

PARTS REQUIRED

8 - LARGE BACK PANEL x2

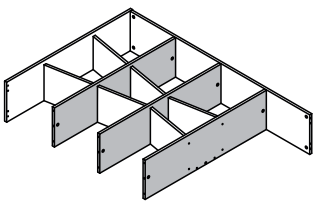

HARDWARE REQUIRED

C  01

G  01

J  01

TOOLS REQUIRED

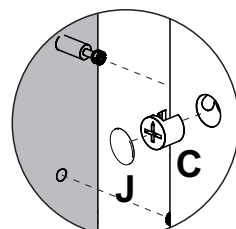
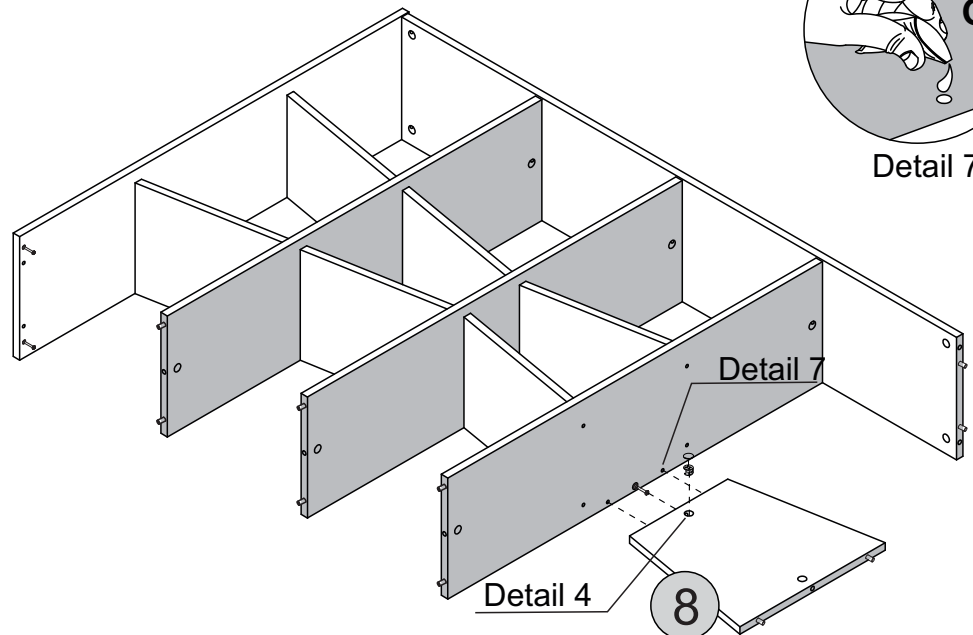
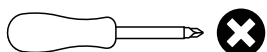

Detail 4

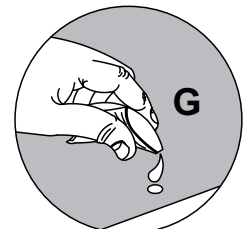
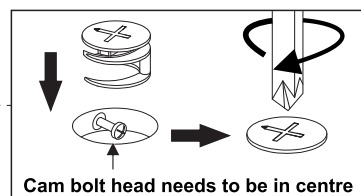

Detail 7

STEP 21

PARTS REQUIRED

2 - SIDE PANEL x1

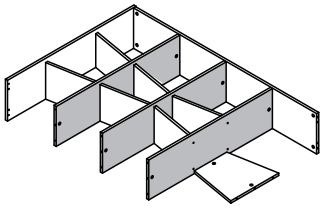

HARDWARE REQUIRED

C  05

G  01

TOOLS REQUIRED

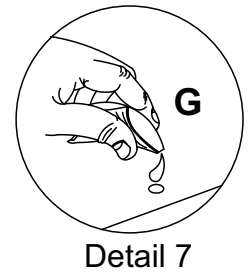
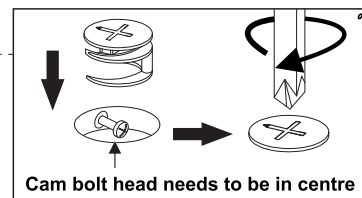
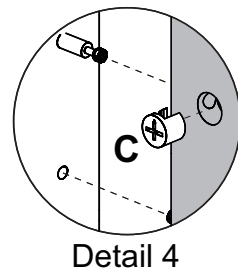
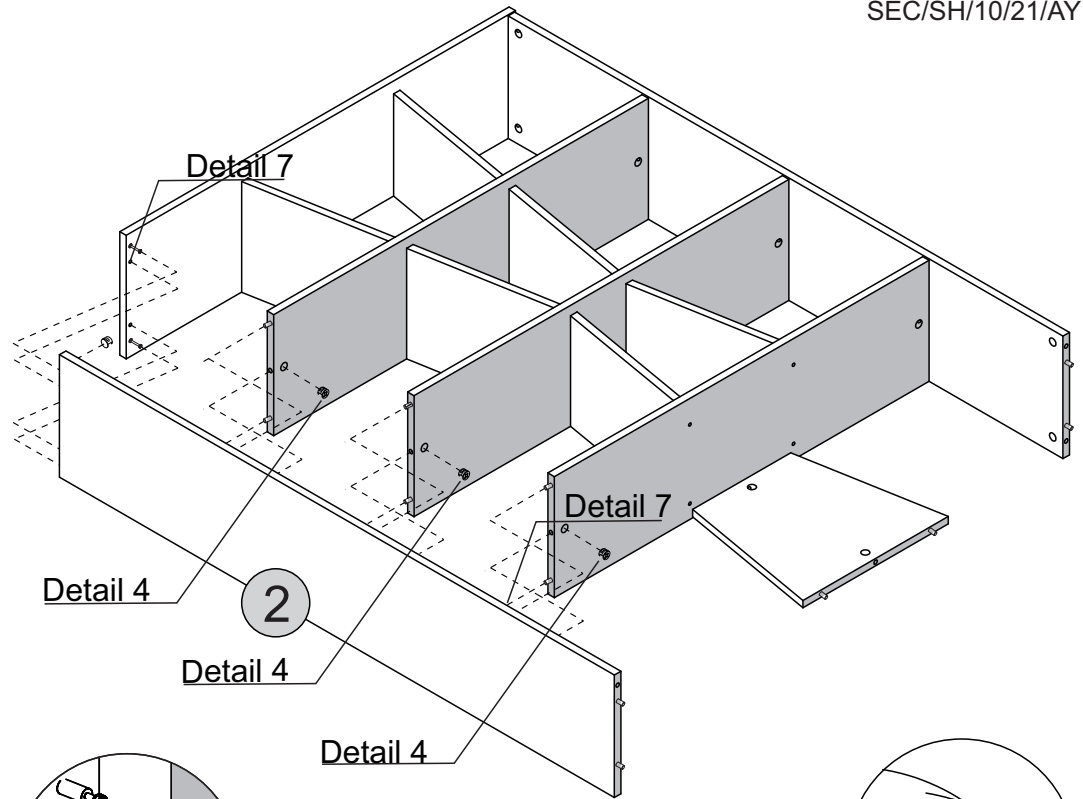
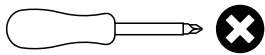

STEP 22

PARTS REQUIRED

6 - OUTER PARTITION x2

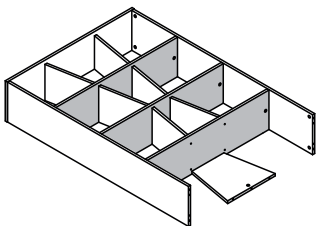

HARDWARE REQUIRED

G  01

TOOLS REQUIRED

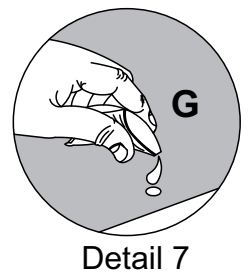
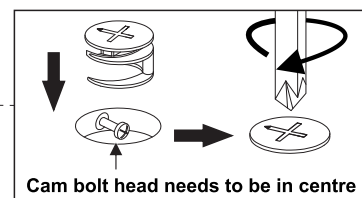
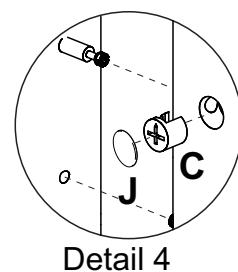
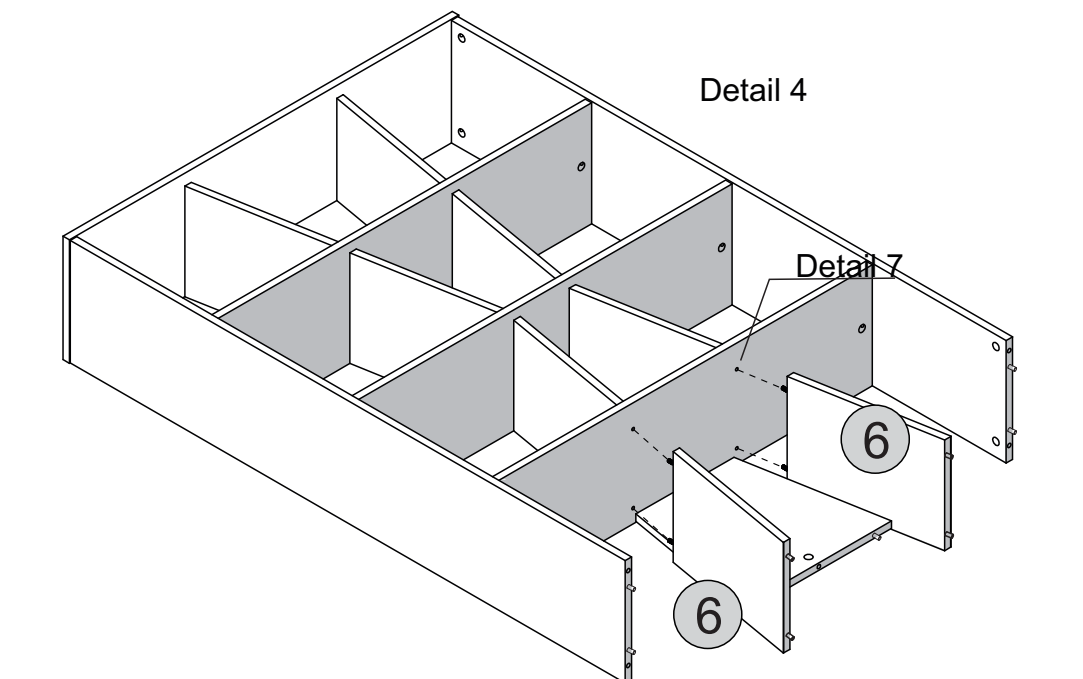
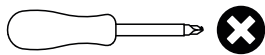

STEP 23

PARTS REQUIRED

3 - BASE PANEL x1

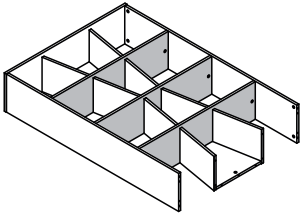

HARDWARE REQUIRED

C  05

G  01

TOOLS REQUIRED

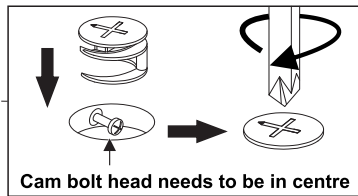
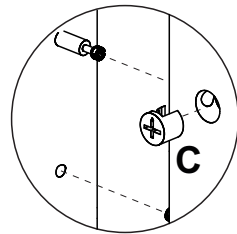
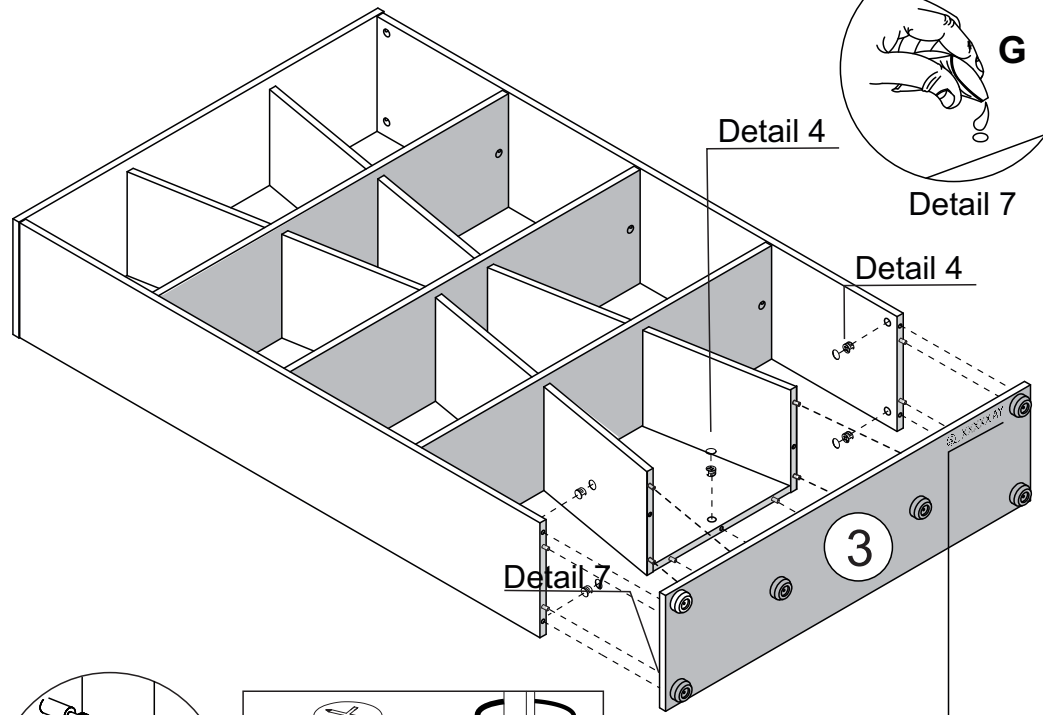
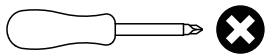

For your future reference order number should be here

Detail 4

STEP 24

PARTS REQUIRED

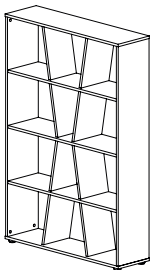

HARDWARE REQUIRED

J  08

TOOLS REQUIRED

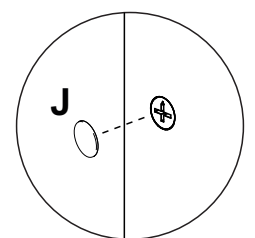
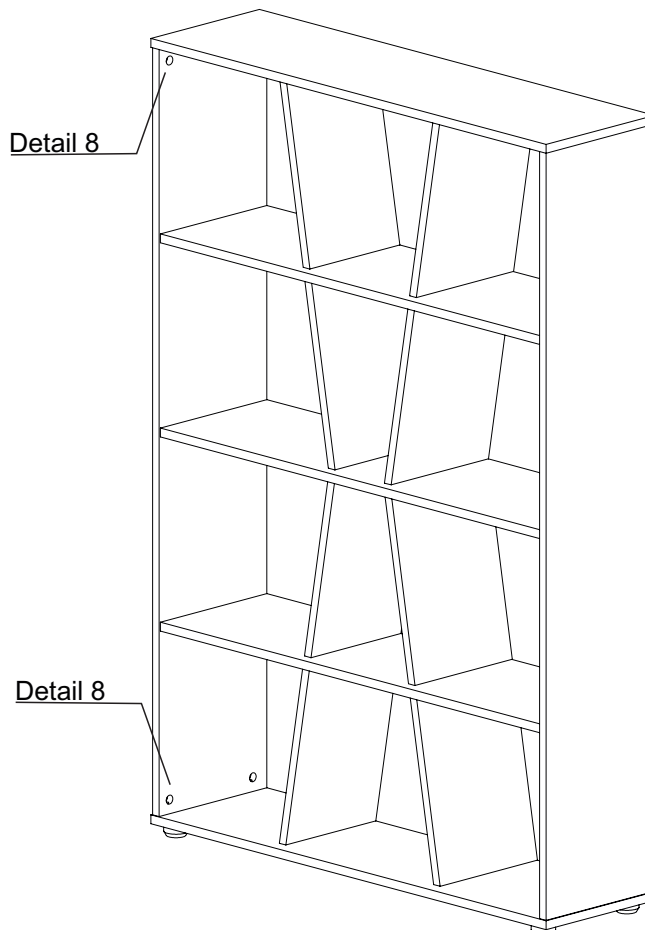

Detail 8

WARNING

Serious or fatal injuries can occur from furniture tipping over. To prevent the furniture from tipping over we recommend that it is permanently fixed to the wall.

Wall fixings are not supplied with this product as different wall materials require different types of fixing devices.

Please make sure you use fixings suitable for the walls in your home.

