

OAK EFFECT NAPLES BREAKFAST BAR/DRINKS CART ASSEMBLY INSTRUCTIONS

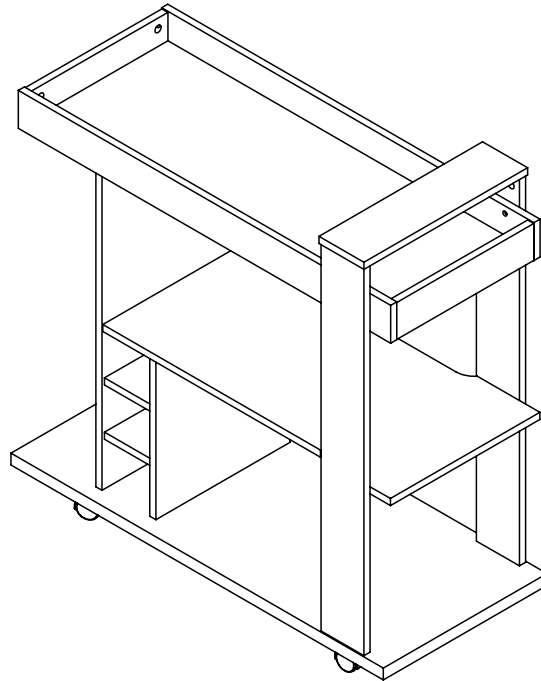

IMPORTANT FOR DOMESTIC USE ONLY

PLEASE READ BEFORE YOU CONTINUE FURTHER

CARE AND MAINTENANCE

After unpacking this product please keep the original packaging in case it needs to be returned for any reason.

- Please ensure all fittings and parts are present before commencing with assembly.
- Never drag or push products as this could cause damage to the joints making it inferior.
- We strongly recommend that you keep children away from your work area.
- We recommend that you lay a blanket or sheet on the floor to avoid damage to both your floor and the product.
- Assemble this product as close to its final position as possible.
- Do not place this product next to a radiator or in direct sunlight.
- Do not drag or push items across your high gloss furniture as this may cause the surface to scratch
- Wood is a natural product and may expand if subjected to damp and may shrink or crack if subjected to heat. Therefore it is recommended that room temperature is maintained, with no sudden temperature fluctuations.
- Make sure any spillage is wiped off immediately.
- Do not place hot or chilled items directly on to the surface, use a place mat or marking will occur.
- For general cleaning use a soft cotton or micro fibre cloth, and do not use detergents of any kind.
- From time to time it may be necessary to tighten fittings, regular inspections should be carried out.
- Do not place on a wet or damp floor as staining may occur to your floor.

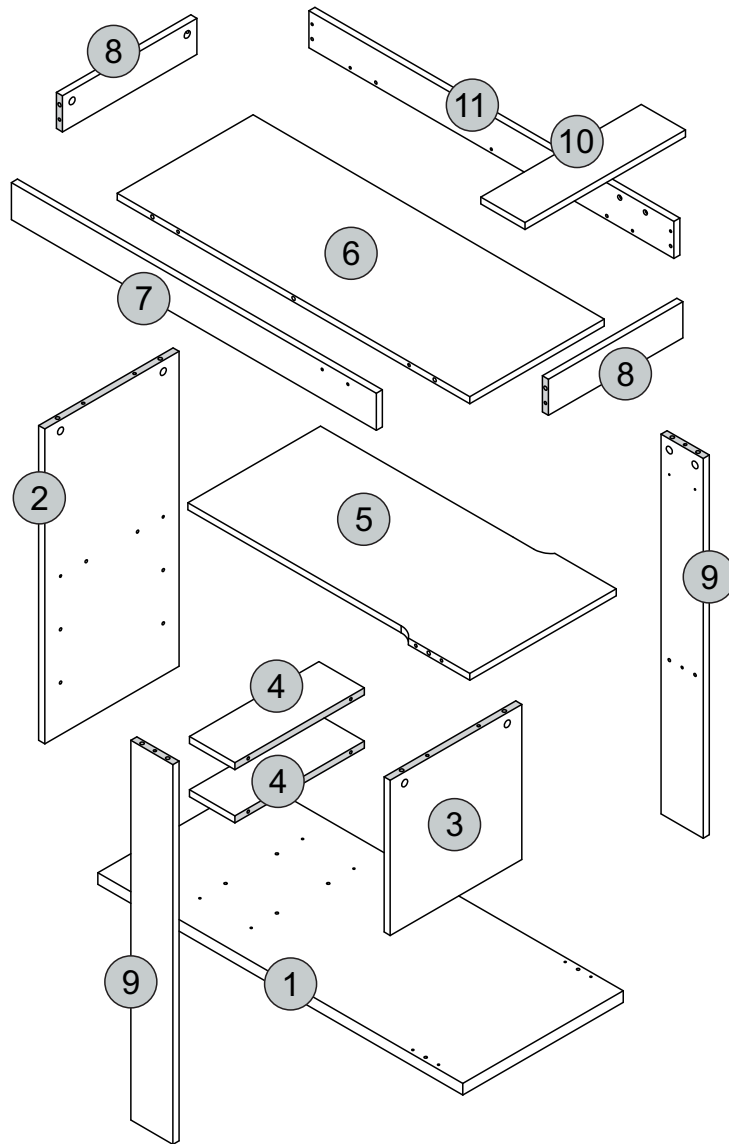

TOOLS REQUIRED

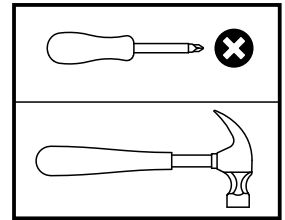





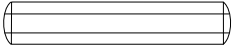
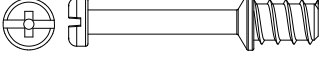
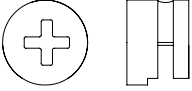

PARTS LIST

Please Note:
The below parts have all been stamped with the part number to help identify them during assembly.

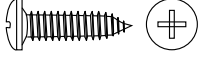
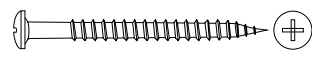
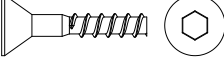
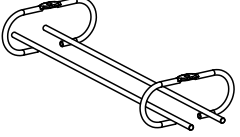
Part Number	Part Code	Part Description	Quantity	Carton
1	S300-320-028-AY1-01	Base Panel	1	1/1
2	S300-320-028-AY1-02	Side Panel	1	1/1
3	S300-320-028-AY1-03	Division Panel	1	1/1
4	S300-320-028-AY1-04	Small Shelf	2	1/1
5	S300-320-028-AY1-05	Large Shelf	1	1/1
6	S300-320-028-AY1-06	Top Panel	1	1/1
7	S300-320-028-AY1-07	Left Large Crossbeam	1	1/1
8	S300-320-028-AY1-08	Small Crossbeam	2	1/1
9	S300-320-028-AY1-09	Upright	2	1/1
10	S300-320-028-AY1-10	Top Crossbeam	1	1/1
11	S300-320-028-AY1-11	Right Large Crossbeam	1	1/1

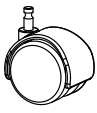
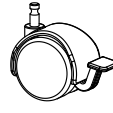
FITTINGS LIST

<p>A</p>  <p>2/+ Dowel Ø6,0 x 30mm (34x)</p>	<p>B</p>  <p>2/+ Cam Bolt (22x)</p>	<p>C</p>  <p>2/+ Cam Nut (22x)</p>	<p>D</p>  <p>Allen Key (1x)</p>
<p>E</p>  <p>1/+ PanHead Screw Ø4,0 x 14mm (4x)</p>	<p>F</p>  <p>1/+ PanHead Screw Ø3,5 x 40mm (8x)</p>	<p>G</p>  <p>1/+ FlatHead Screw Ø5,0 x 24mm (4x)</p>	<p>H</p>  <p>Cup Holder (2x)</p>
<p>J</p>  <p>2/+ Hole Plugs(16x)</p>	<p>K</p>  <p>1/+ Bushing Ø30x16mm (4x)</p>	<p>L</p>  <p>Rf40 Caster Without Lock 60x40mm - Plastic (2x)</p>	<p>M</p>  <p>Rf40 Caster With Lock 60x40mm - Plastic (2x)</p>
<p>N</p>  <p>Glue(2x)</p>			

TIPS FOR FITTINGS CAM-LOCKS

WHEN FITTING CAM NUT. ENSURE STARTING POSITION IS CORRECT BEFORE YOU INSERT CONNECTING CAM BOLT TURN CLOCKWISE UNTIL SECURE

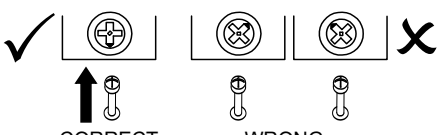

CORRECT **WRONG**

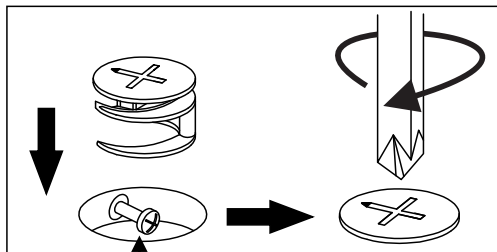

Cam bolt head needs to be in centre

CAMBOLT

Tighten until shoulder in flush with panel. Do not overtighten or undertighten (see example below)

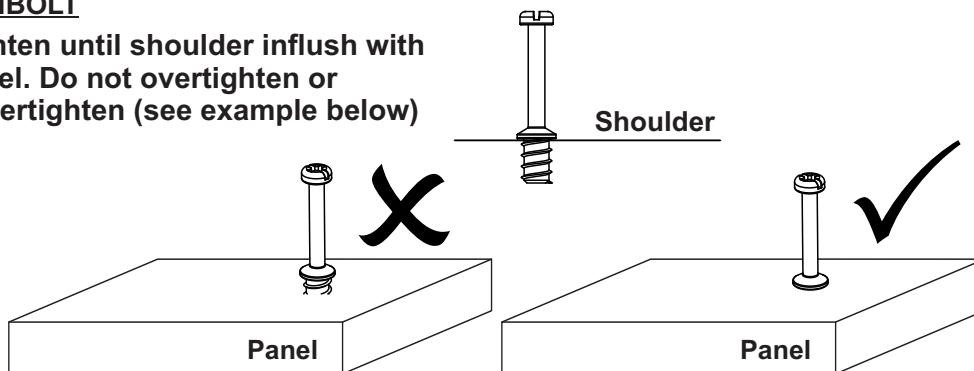

STEP 1

PARTS REQUIRED

1 - BASE PANEL x1

HARDWARE REQUIRED

K  04

L  02

M  02

TOOLS REQUIRED

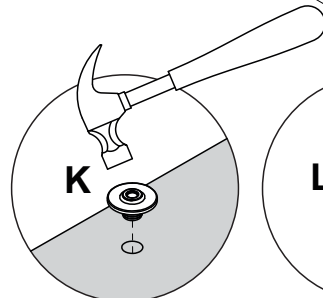
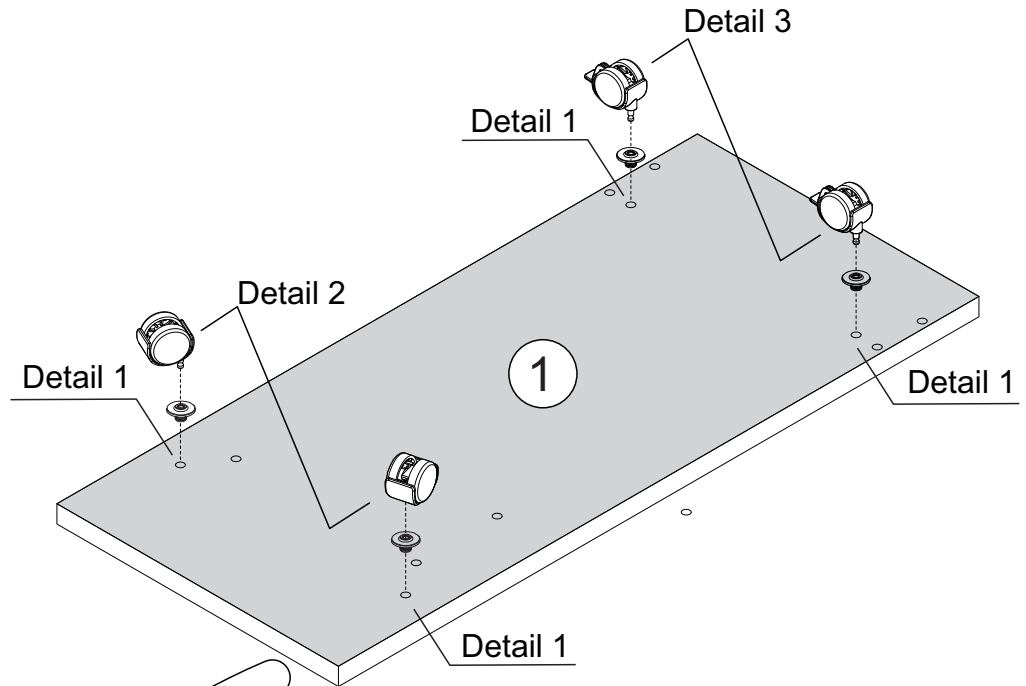
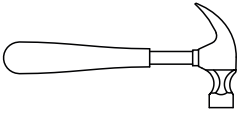

Detail 1

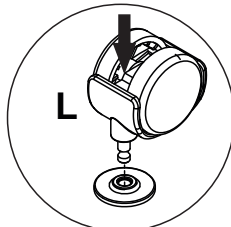

Detail 2

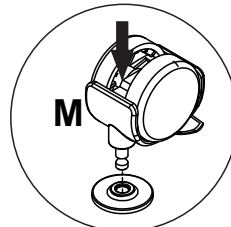

Detail 3

STEP 2

PARTS REQUIRED

2 - SIDE PANEL x1

HARDWARE REQUIRED

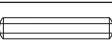
A  04

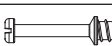
B  02

N  GLUE 01

TOOLS REQUIRED

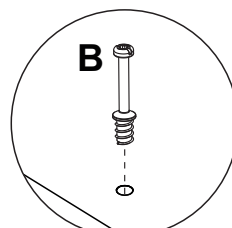
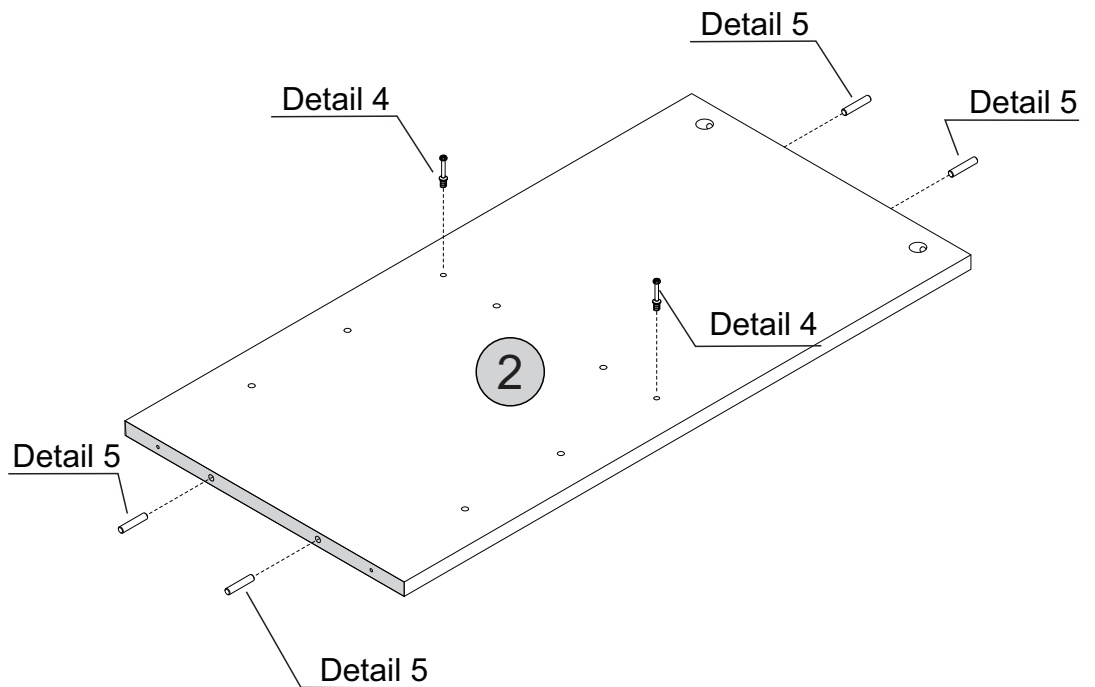
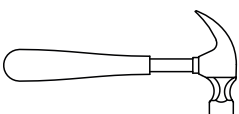
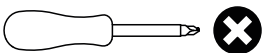

Detail 4

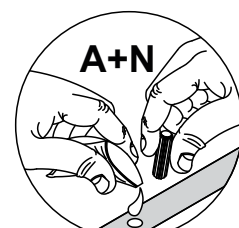
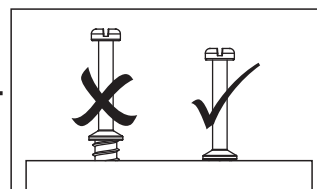



Detail 5

STEP 3

PARTS REQUIRED

3 - DIVISION PANEL x1

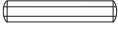
HARDWARE REQUIRED

- A  04
- N  01

TOOLS REQUIRED

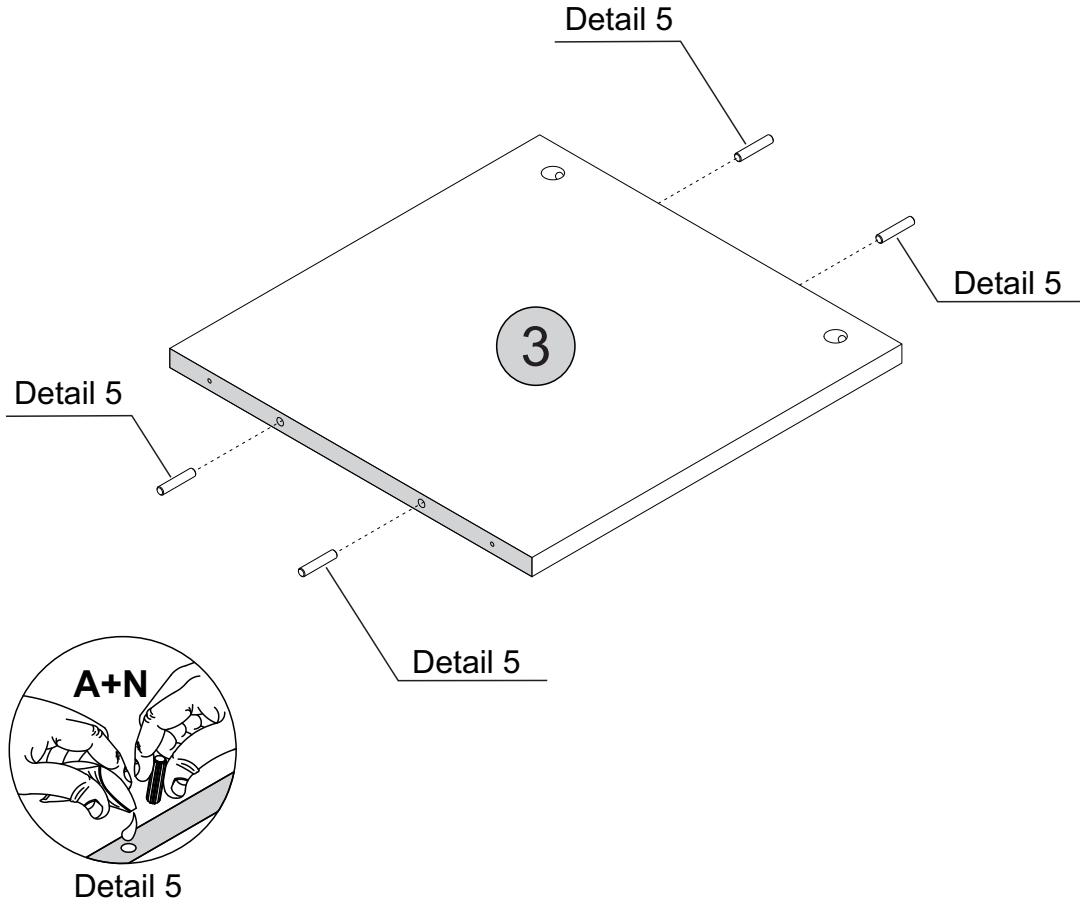
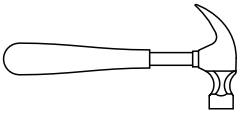



STEP 4

PARTS REQUIRED

4 - SMALL SHELF x2

HARDWARE REQUIRED

- A  08
- N  01

TOOLS REQUIRED

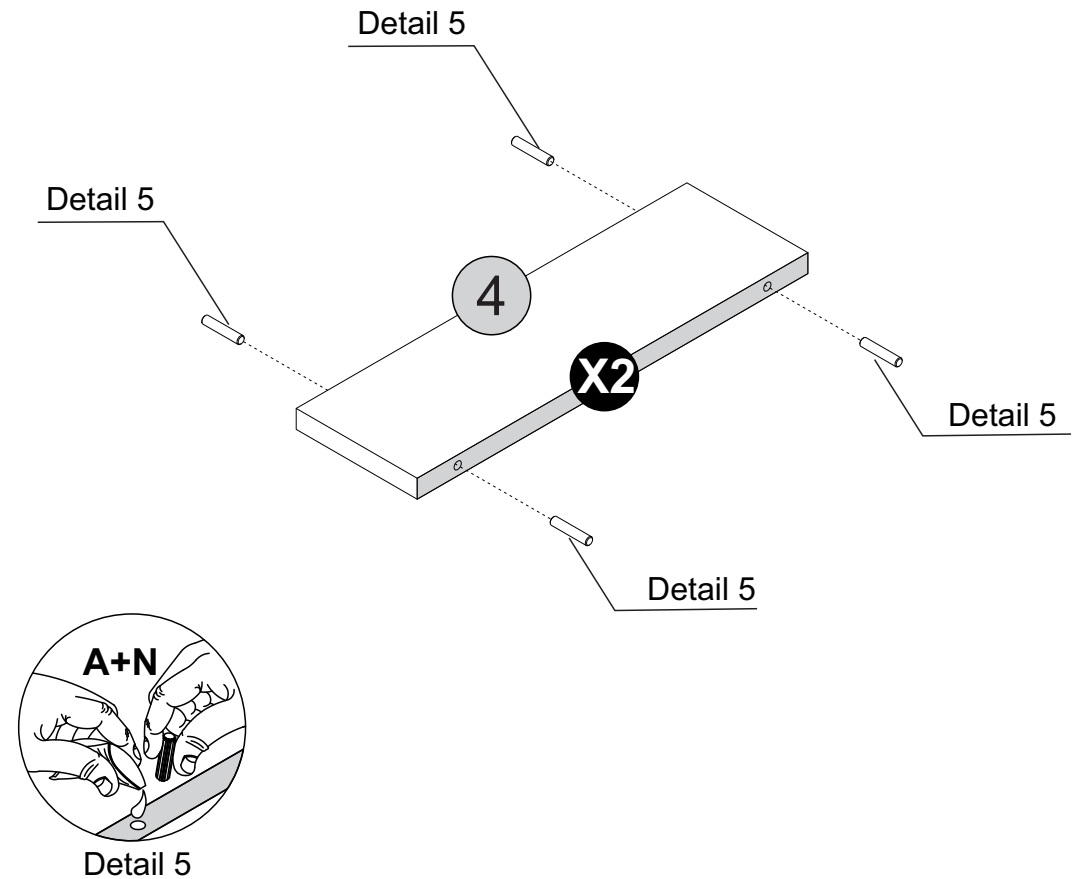
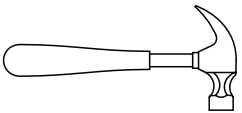



STEP 5

PARTS REQUIRED

5 - LARGE SHELF x1

HARDWARE REQUIRED

A  06

B  02

N  GLUE 01

TOOLS REQUIRED

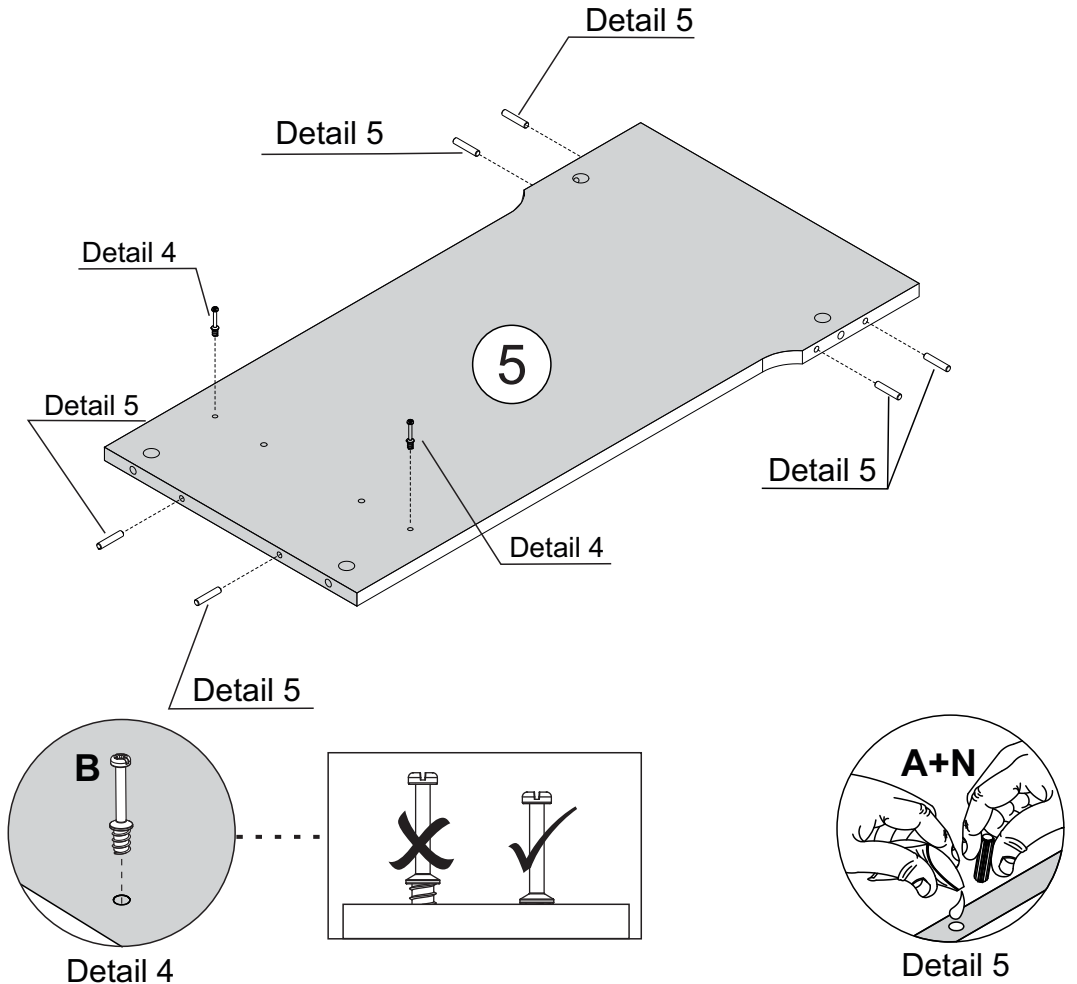
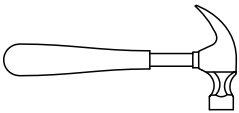
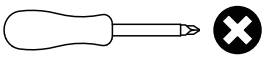

STEP 6

PARTS REQUIRED

6 - TOP PANEL x1

HARDWARE REQUIRED

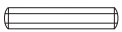
A  04

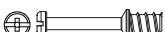
B  02

N  GLUE 01

TOOLS REQUIRED

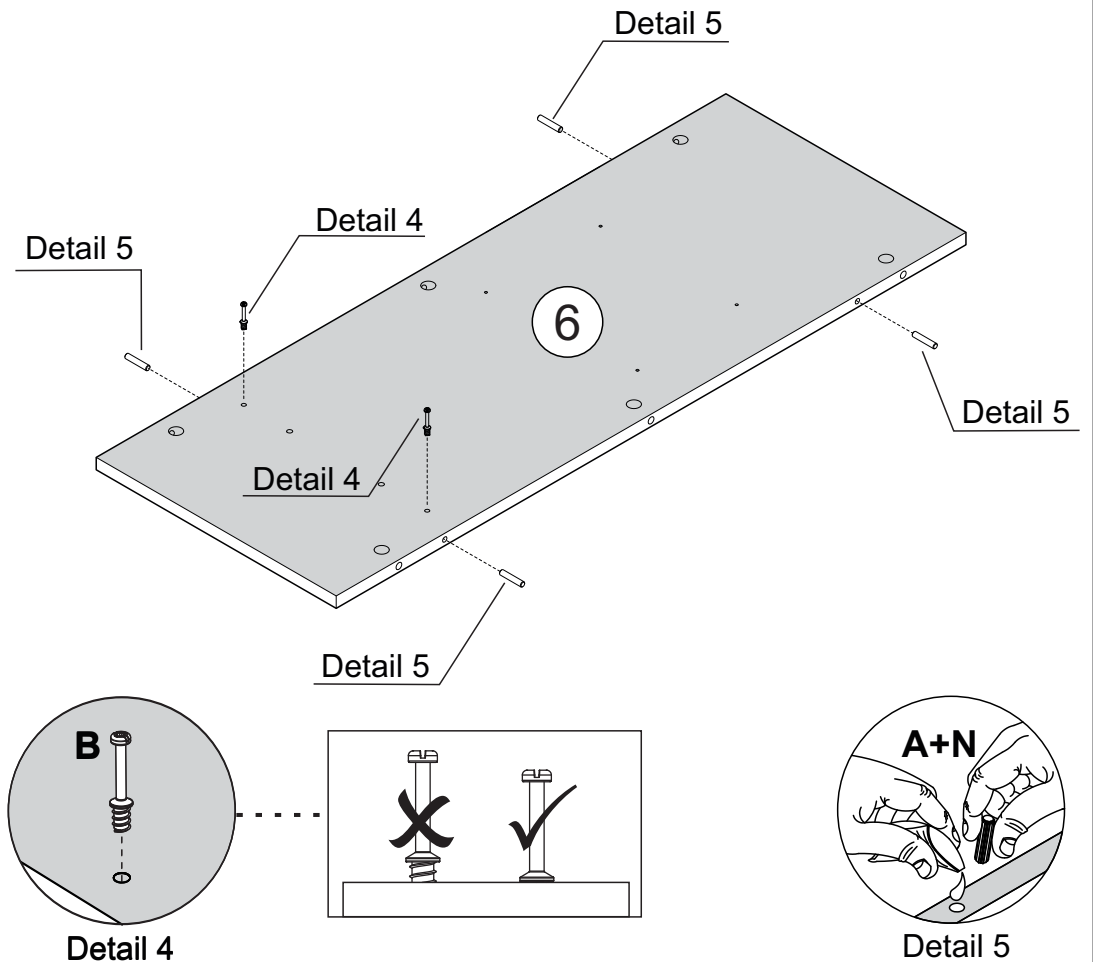
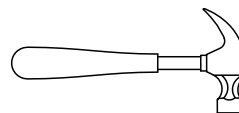
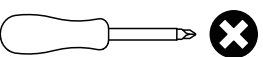

STEP 7

PARTS REQUIRED

6 - TOP PANEL x1

HARDWARE REQUIRED

E  04

H  02

TOOLS REQUIRED

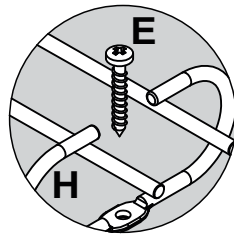
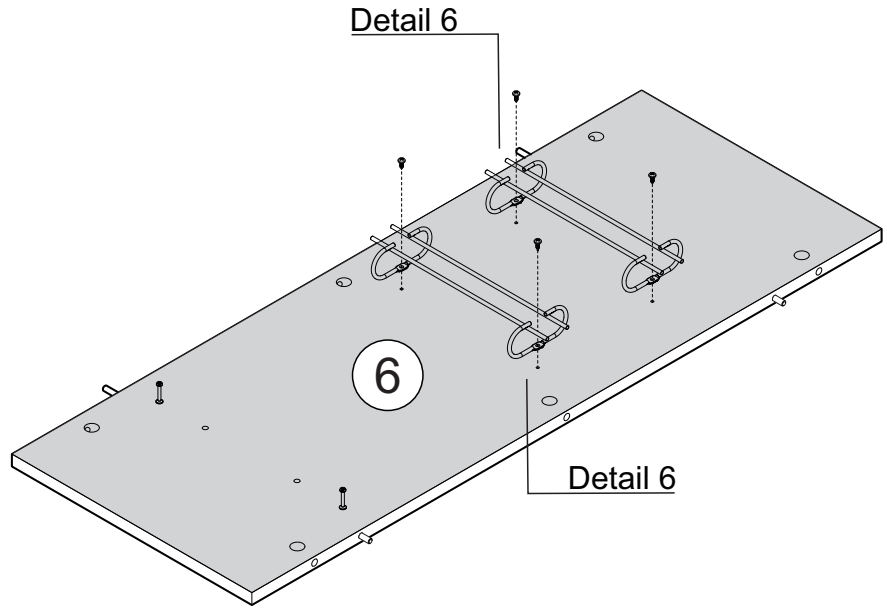
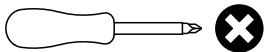

Detail 6

STEP 8

PARTS REQUIRED

7 - LEFT LARGE CROSSBEAM x1

HARDWARE REQUIRED

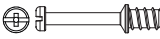
B  05

TOOLS REQUIRED

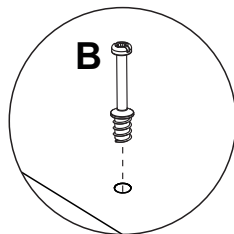
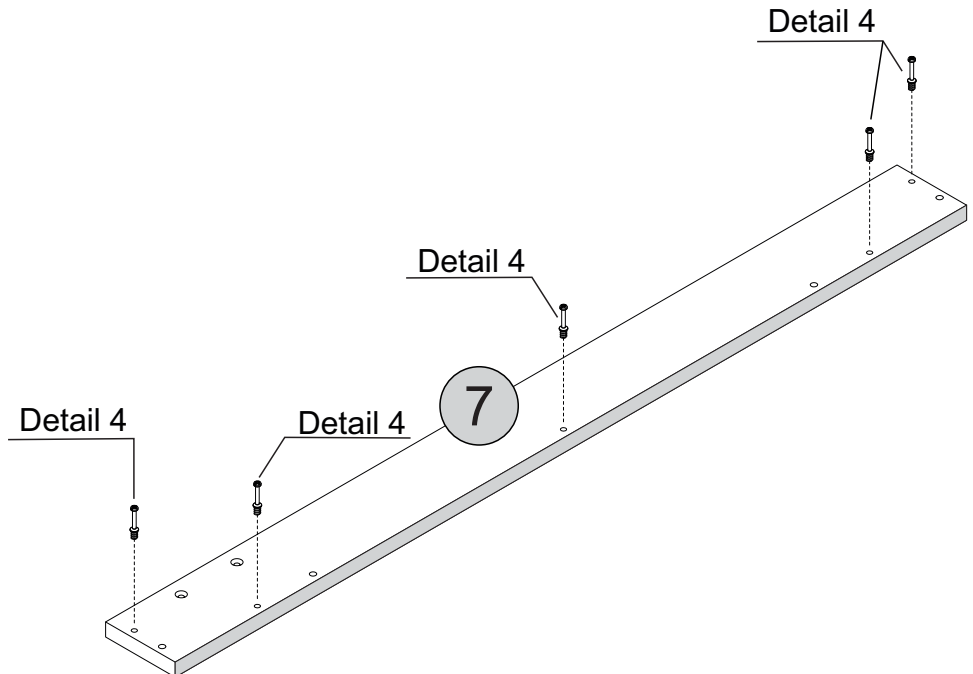
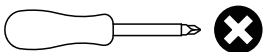

Detail 4

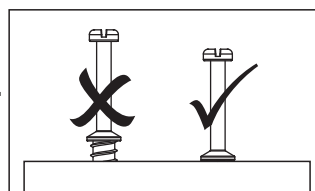

STEP 9

PARTS REQUIRED

8 - SMALL CROSSBEAM x2

HARDWARE REQUIRED

A  04

N  01

TOOLS REQUIRED

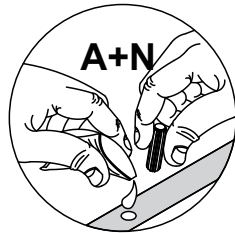
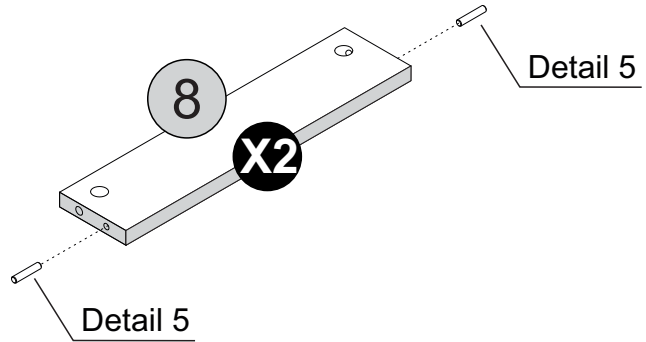
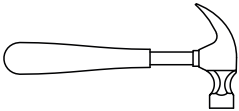

Detail 5

STEP 10

PARTS REQUIRED

9 - UPRIGHT x2

HARDWARE REQUIRED

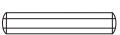
A  04

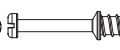
B  02

N  01

TOOLS REQUIRED

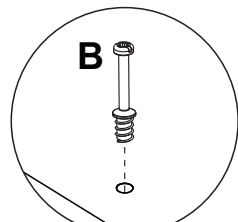
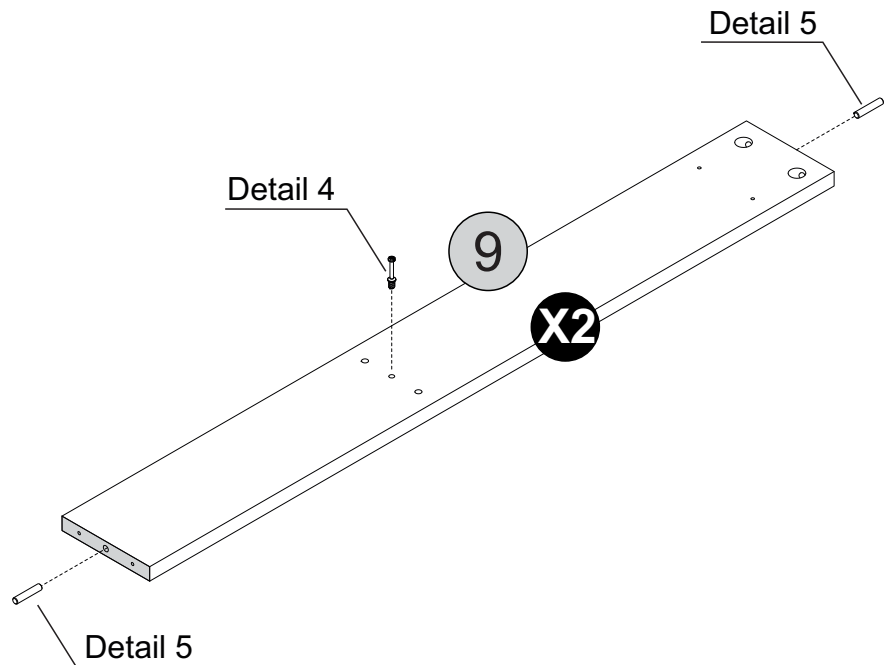
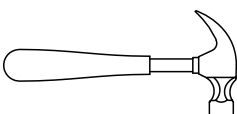
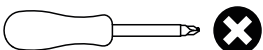

Detail 4

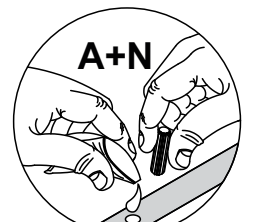
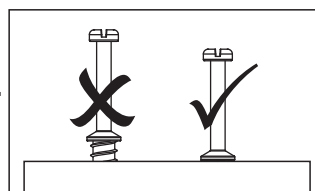

Detail 5

STEP 11

PARTS REQUIRED

10 - TOP CROSSBEAM x1

HARDWARE REQUIRED

B  04

TOOLS REQUIRED

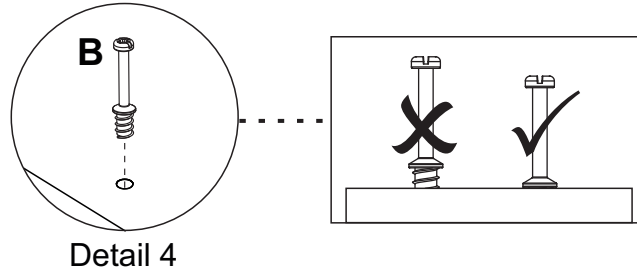
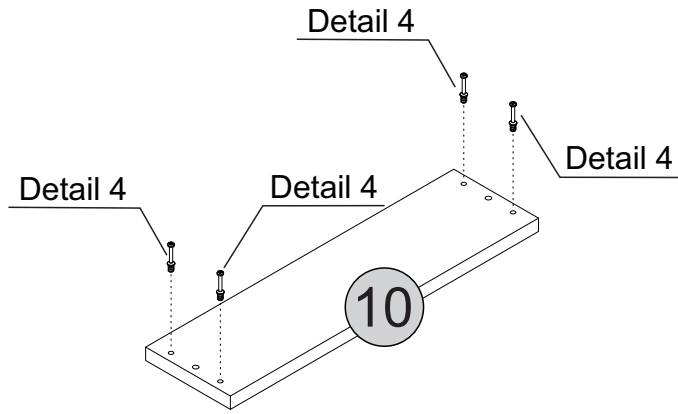
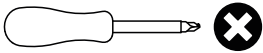

STEP 12

PARTS REQUIRED

11 - RIGHT LARGE CROSSBEAMx1

HARDWARE REQUIRED

B  05

TOOLS REQUIRED

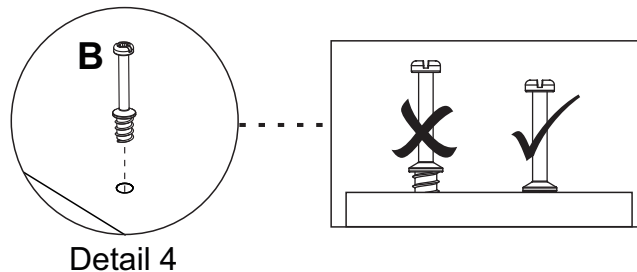
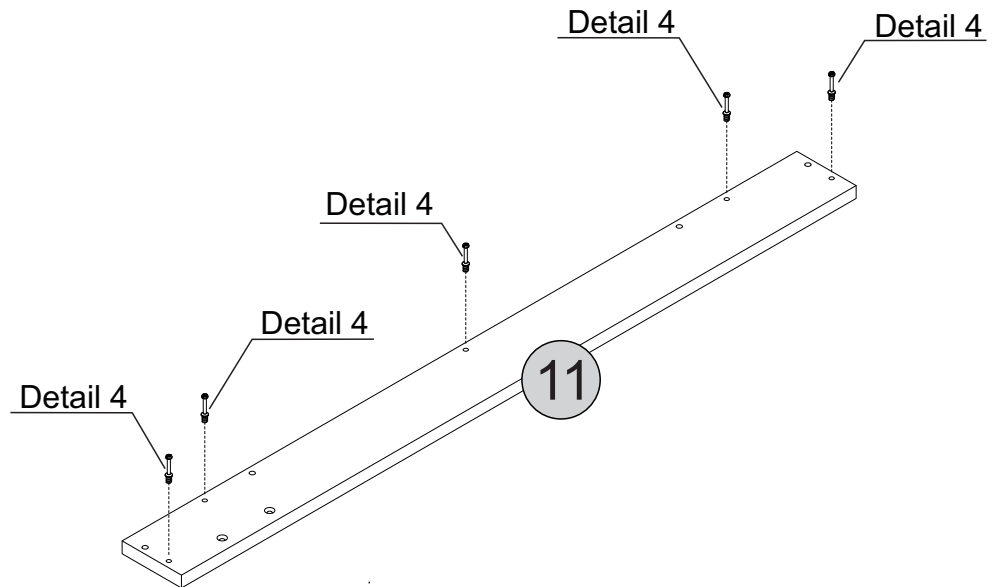
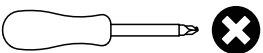

STEP 13

PARTS REQUIRED

6 - TOP x1

11 - RIGHT LARGE CROSSBEAM x1

HARDWARE REQUIRED

C  03

N  01

TOOLS REQUIRED

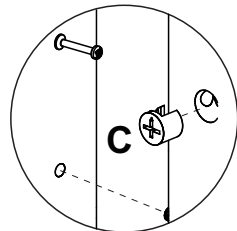
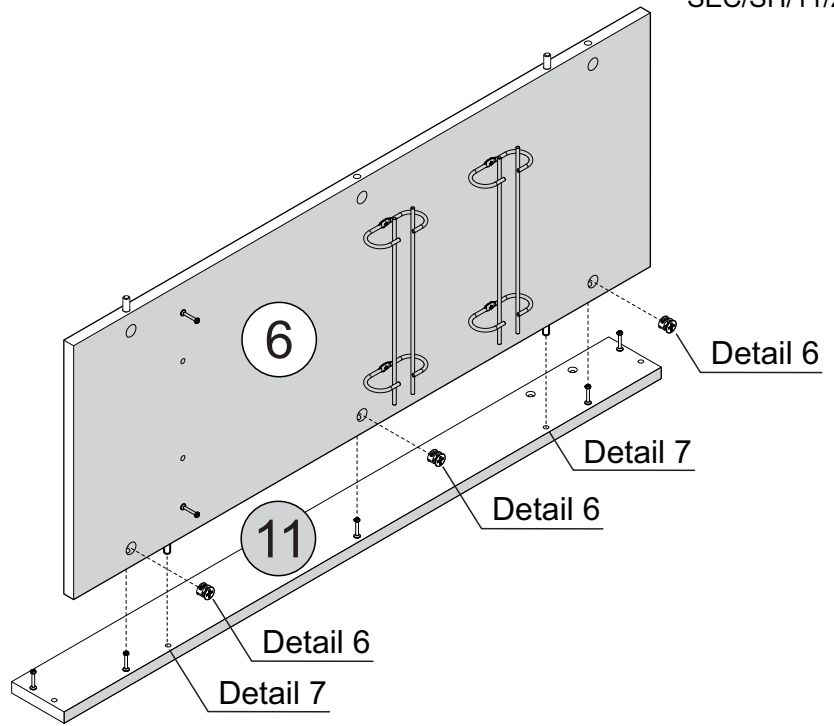
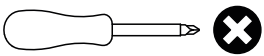

Detail 6

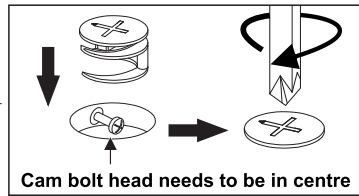

Cam bolt head needs to be in centre

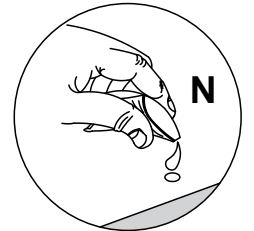

Detail 7

STEP 14

PARTS REQUIRED

8 - SMALL CROSSBEAM x2

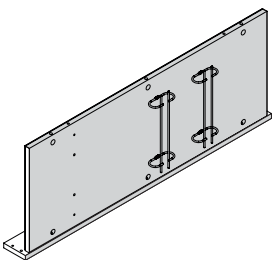

HARDWARE REQUIRED

TOOLS REQUIRED

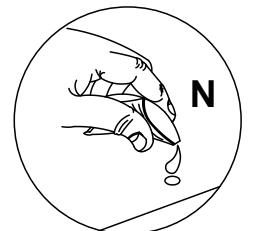
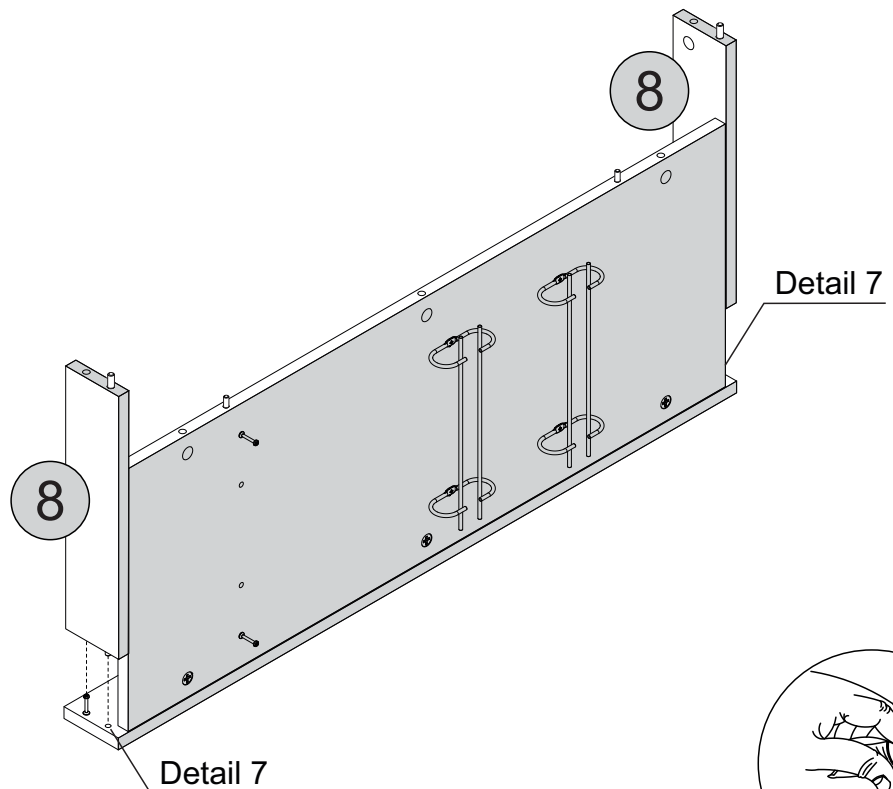

Detail 7



STEP 15

PARTS REQUIRED

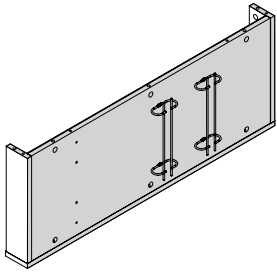
7 - LEFT LARGE CROSSBEAMx1



HARDWARE REQUIRED

C   03

N  01

TOOLS REQUIRED

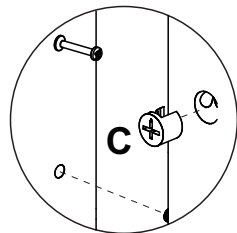
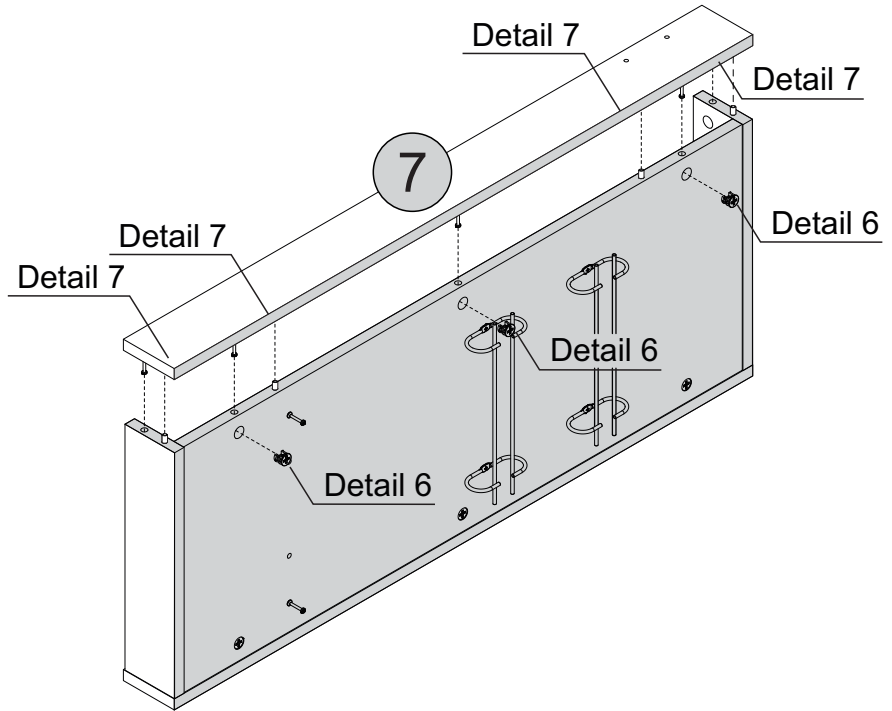
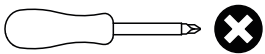

Detail 6

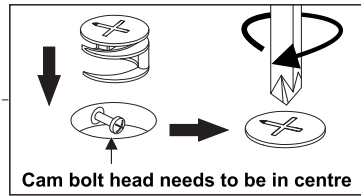

Detail 7

STEP 16

PARTS REQUIRED

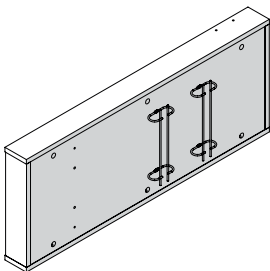

HARDWARE REQUIRED

C   04

J  04

TOOLS REQUIRED

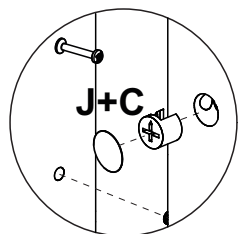
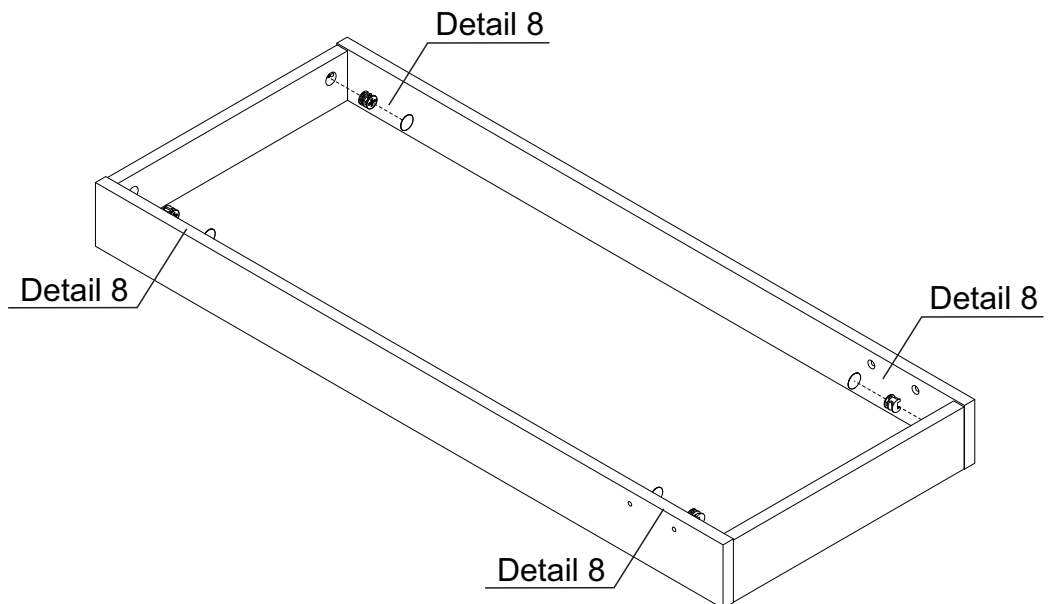
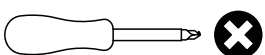

Detail 8

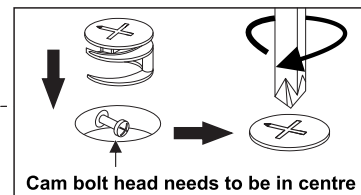



STEP 17

PARTS REQUIRED

- 2 - SIDE PANEL x1
- 5 - LARGE SHELF x1

HARDWARE REQUIRED

- C  02
- N  01

TOOLS REQUIRED

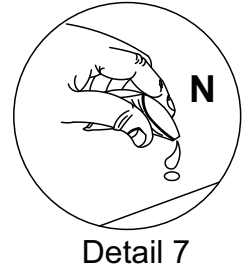
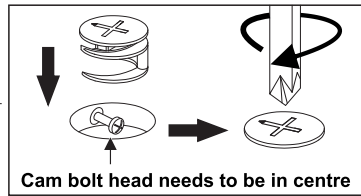
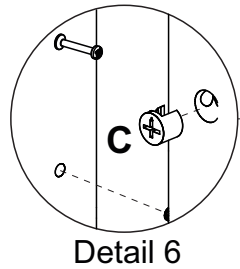
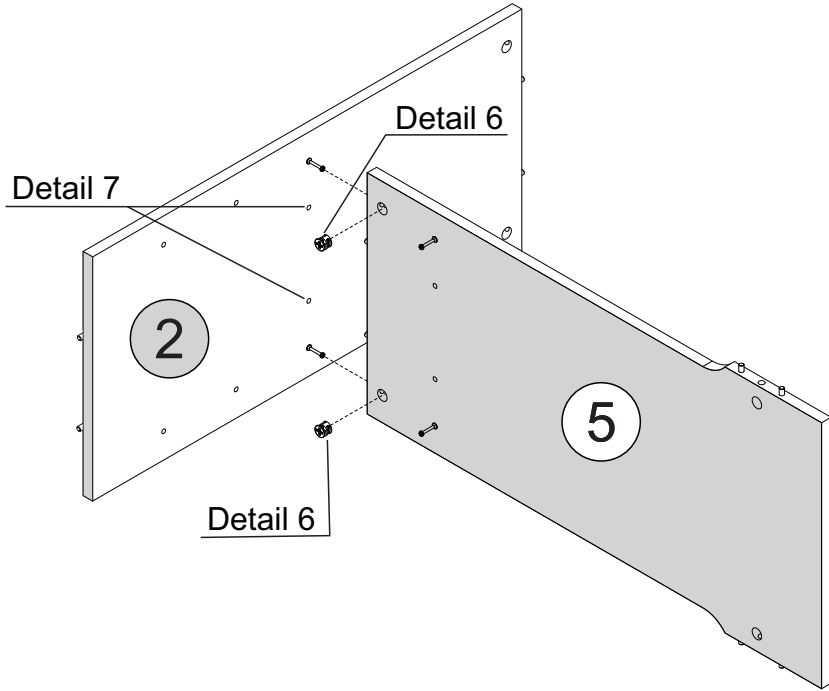
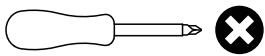

STEP 18

PARTS REQUIRED

- 4 - SMALL SHELF x2

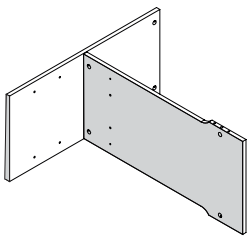

HARDWARE REQUIRED

- N  01

TOOLS REQUIRED

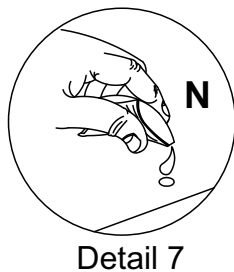
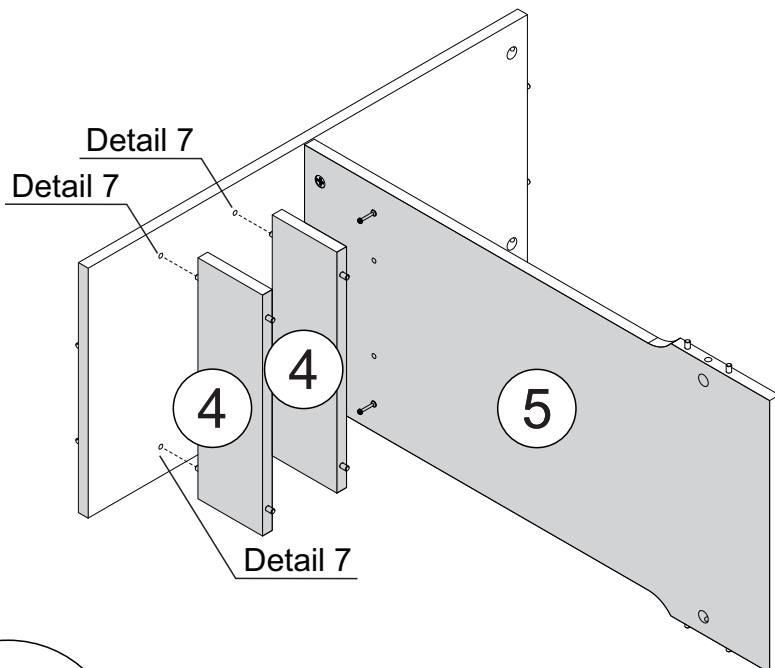

STEP 19

PARTS REQUIRED

3 - DIVISION PANEL x1

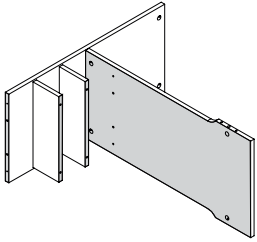

HARDWARE REQUIRED

C  02

J  02

N  01

TOOLS REQUIRED

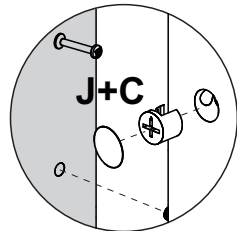
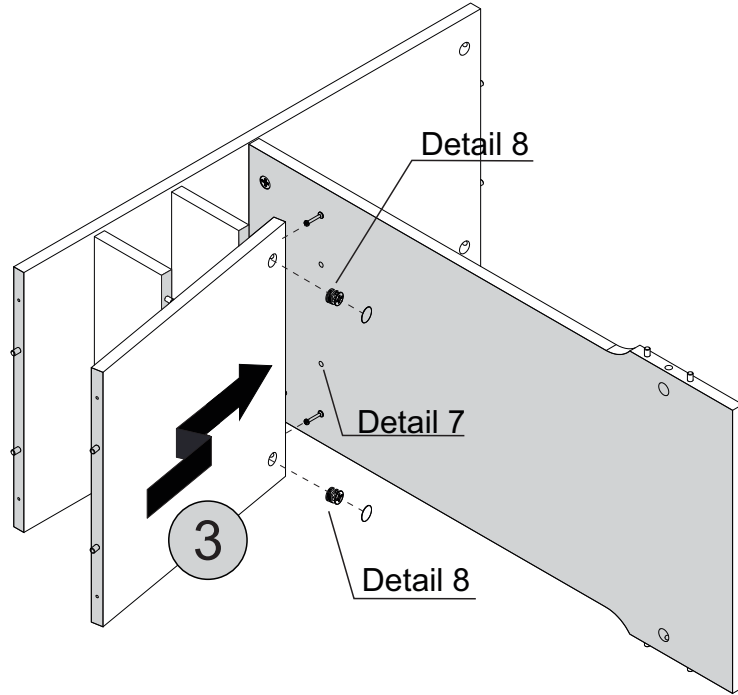
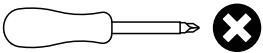

Detail 8

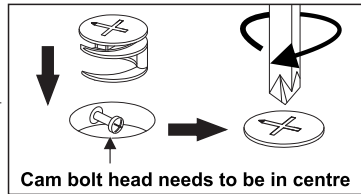

Cam bolt head needs to be in centre

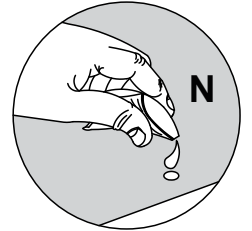

Detail 7

STEP 20

PARTS REQUIRED

9 - UPRIGHT x2

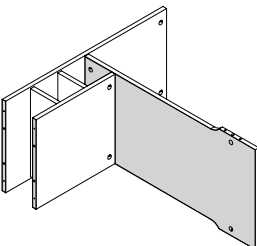

HARDWARE REQUIRED

C  02

N  01

TOOLS REQUIRED

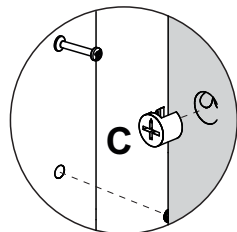
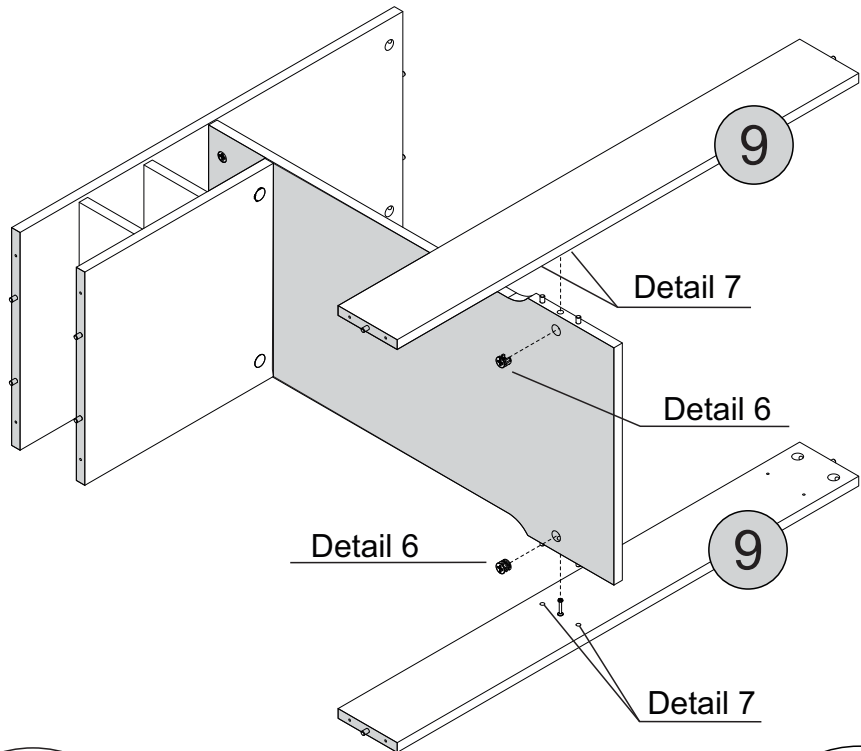
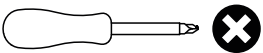

Detail 6

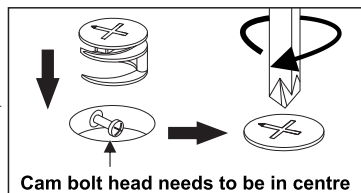

Cam bolt head needs to be in centre

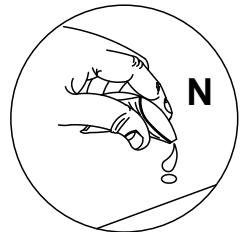

Detail 7

STEP 21

PARTS REQUIRED

1 - BASE PANEL x1

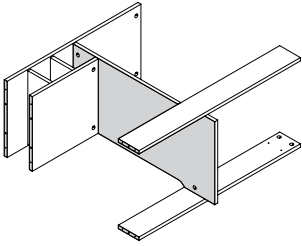

HARDWARE REQUIRED

F  08

TOOLS REQUIRED

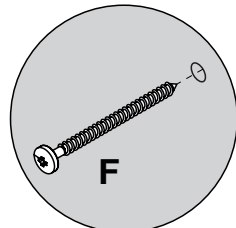
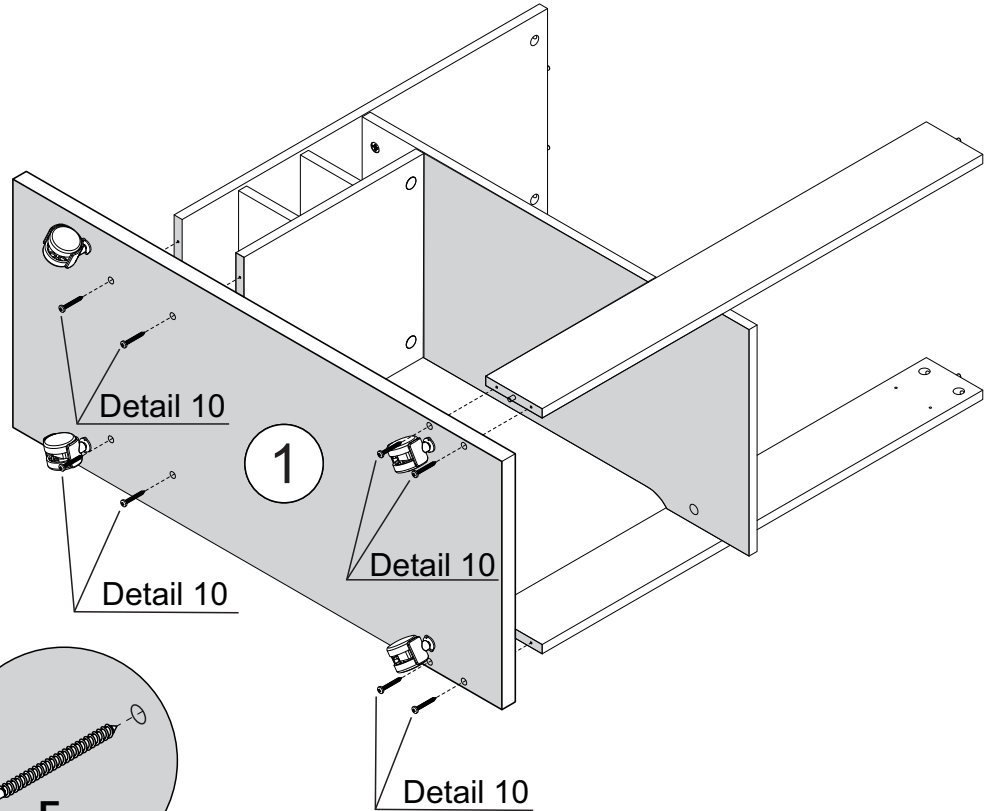
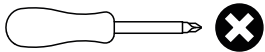

Detail 10

STEP 22

PARTS REQUIRED

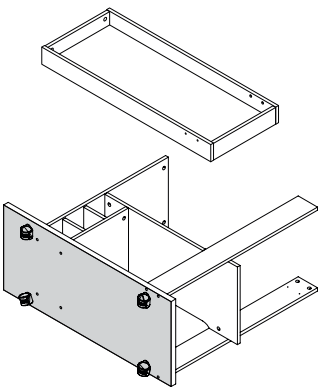

HARDWARE REQUIRED

C   02

J  02

N  01

TOOLS REQUIRED

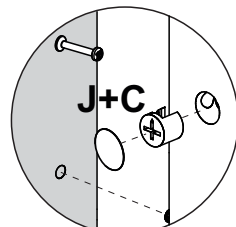
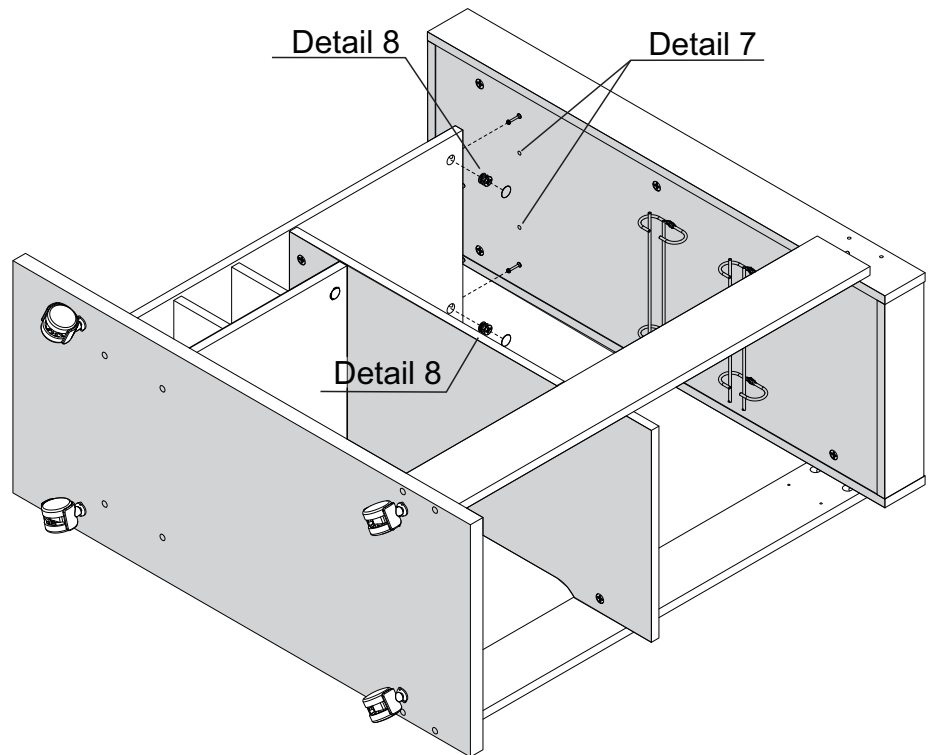
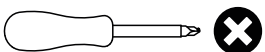

Detail 8

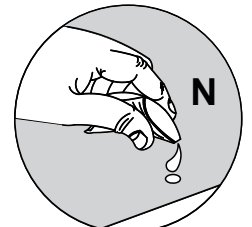
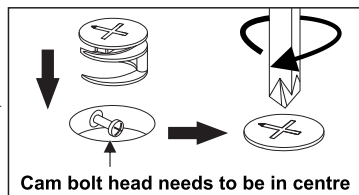

Detail 7

STEP 23

PARTS REQUIRED

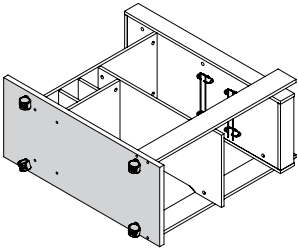

HARDWARE REQUIRED

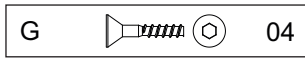

TOOLS REQUIRED

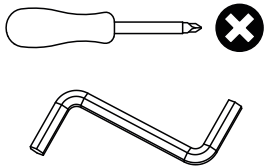

Detail 11+12

Detail 11+12

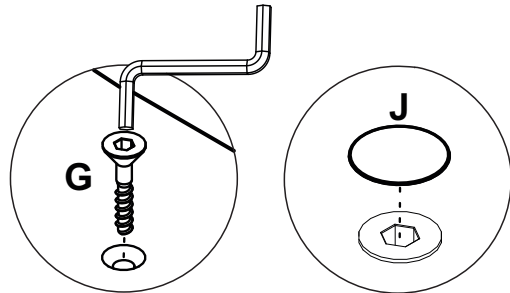

Detail 11

Detail 12

STEP 24

PARTS REQUIRED

10 - TOP CROSSBEAM x1

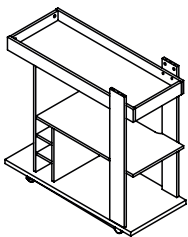

HARDWARE REQUIRED

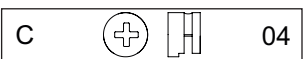

TOOLS REQUIRED

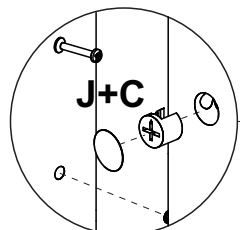
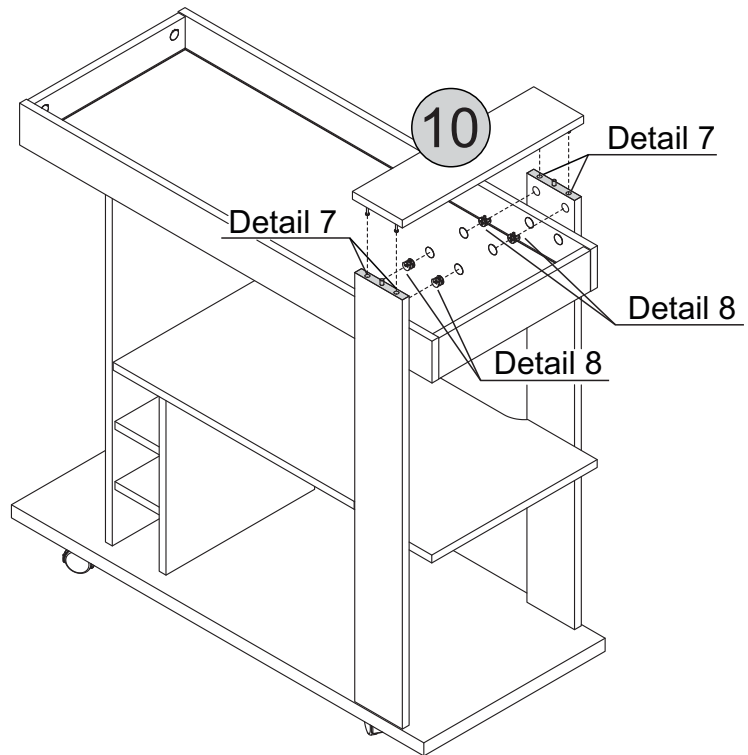
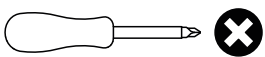

Detail 8

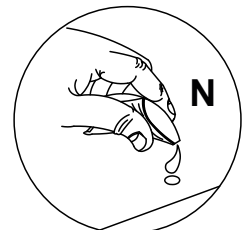
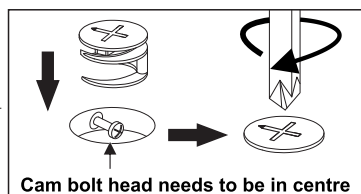

Detail 7

STEP 25

SEC/SH/11/21/AY1

PARTS REQUIRED

HARDWARE REQUIRED

TOOLS REQUIRED

