

# GREY SALVADOR 1+2 DINING CHAIR ASSEMBLY INSTRUCTIONS

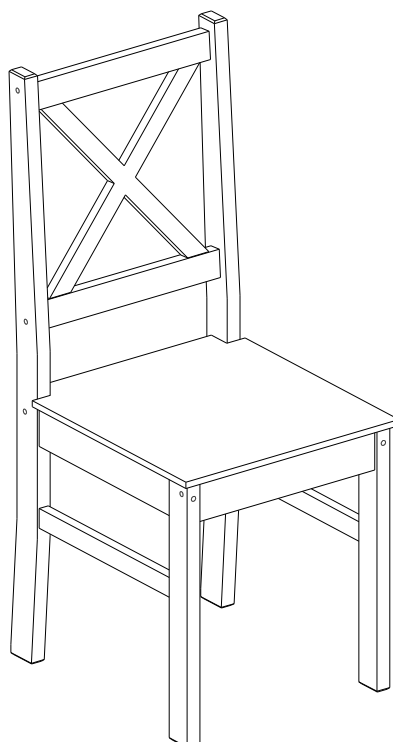
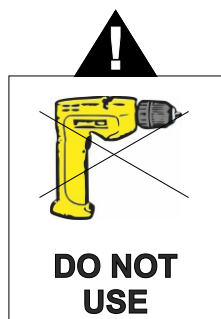

## **IMPORTANT FOR DOMESTIC USE ONLY**

**PLEASE READ BEFORE YOU CONTINUE FURTHER**

## **CARE AND MAINTENANCE**

After unpacking this product please keep the original packaging in case it needs to be returned for any reason.

- Please ensure all fittings and parts are present before commencing with assembly.
- We recommend that you lay a blanket or sheet on the floor to avoid damage to both your floor and the product.
- We strongly recommend that you keep children away from your work area.
- Assemble this product as close to its final position as possible.
- Never drag or push products as this could cause damage to the joints making it inferior.
- Do not place this product next to a radiator or in direct sunlight.
- Wood is a natural product and may expand if subjected to damp and may shrink or crack if subjected to heat. Therefore it is recommended that room temperature is maintained, with no sudden temperature fluctuations.
- Make sure any spillage is wiped off immediately.
- Do not place hot or chilled items directly on to the surface, use a place mat or marking will occur.
- For general cleaning use a duster, and do not use detergents of any kind. However, the surface will need to be retreated from time to time. This can be done by using block wax (unperfumed) and rubbing it over the whole item.
- From time to time it may be necessary to tighten fittings, regular inspections should be carried out.

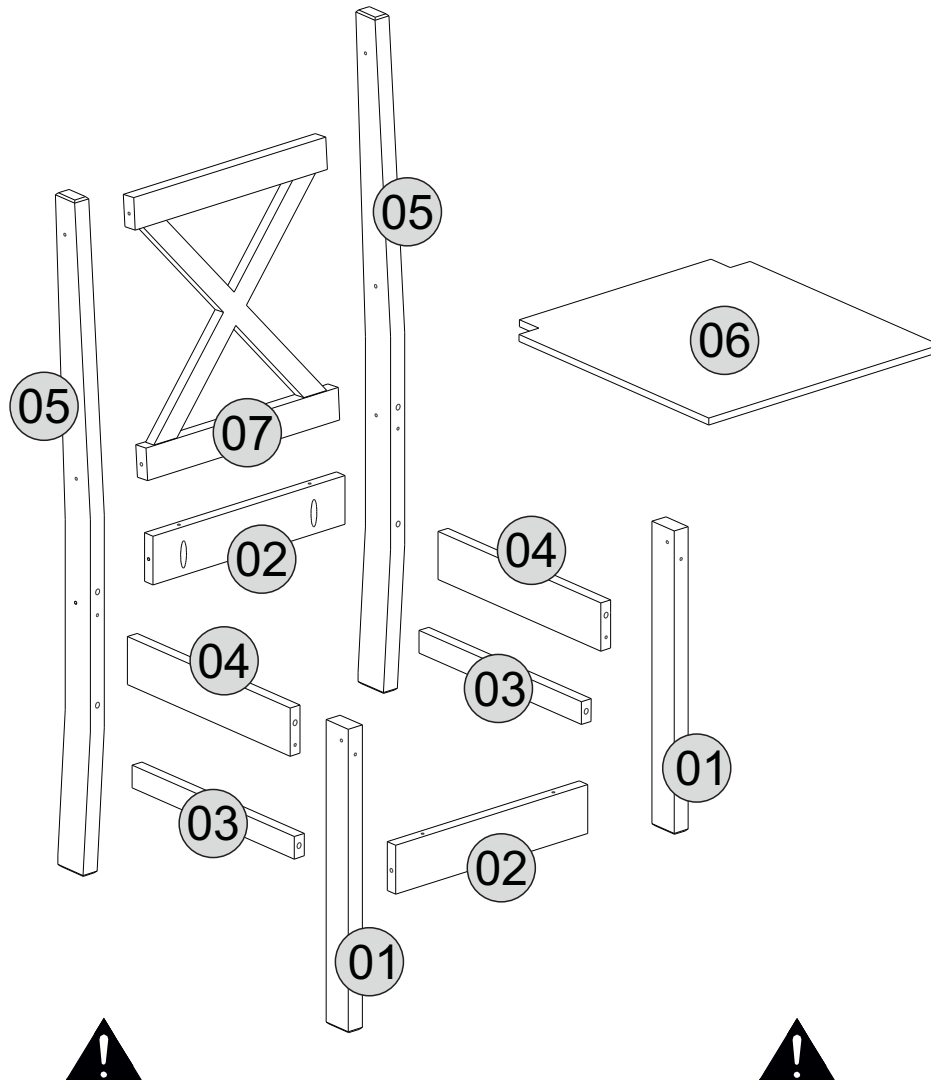



\* Use of power tools to assemble this product will invalidate any claim and damage this product making it unsafe !!!  
\* Please assemble on a clean soft surface to avoid damage.

\* Please check contents and read the instructions before commencing assembly.  
\* Assemble this product following the enclosed instructions carefully.  
\* Please take care to avoid damaging panels during assembly.

## PARTS LIST

Part Number	Part Code	Part Description	Quantity	Carton
01	S400-401-172-KK1-01C	Front Leg	2	1/1
02	S400-401-172-KK1-02C	Back/Front Rail	2	1/1
03	S400-401-172-KK1-03C	Stretcher	2	1/1
04	S400-401-172-KK1-04C	Side Seat Rail	2	1/1
05	S400-401-172-KK1-05C	Back Leg	2	1/1
06	S400-401-172-KK1-06C	Seat Pad	1	1/1
07	S400-401-172-KK1-07C	Back Rail	1	1/1

## FITTINGS

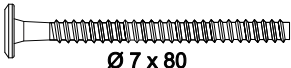
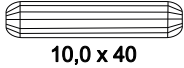
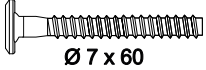
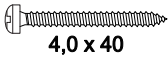
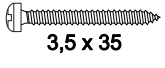
<b>A</b>	 GLUE	<b>01</b>	<b>E</b>		<b>01</b>
<b>B</b>	 Ø 7 x 80	<b>04</b>	<b>F</b>	 10,0 x 40	<b>08</b>
<b>C</b>	 Ø 7 x 60	<b>08</b>	<b>G</b>	 4,0 x 40	<b>04</b>
<b>D</b>	 3,5 x 35	<b>04</b>			

## TOOLS REQUIRED

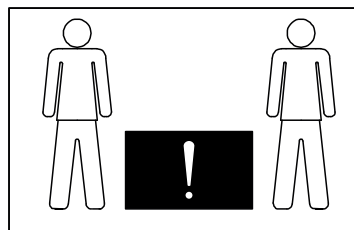
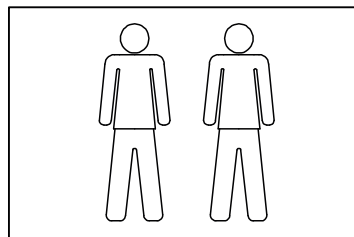
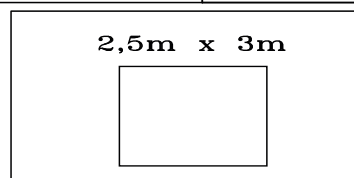
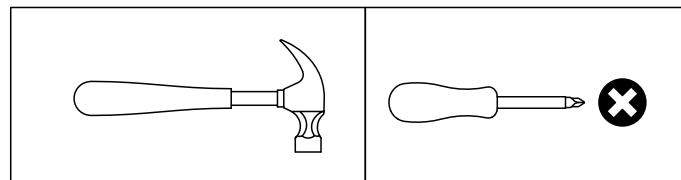

# STEP 1

## PARTS REQUIRED

03 - STRETCHER x2

04 - SIDE SEAT RAIL x2

## HARDWARE REQUIRED

A  01

F  10,0 x 40 08

## TOOLS REQUIRED

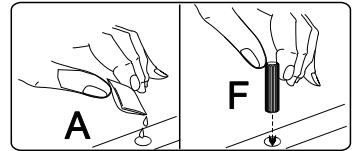

**ADD GLUE**

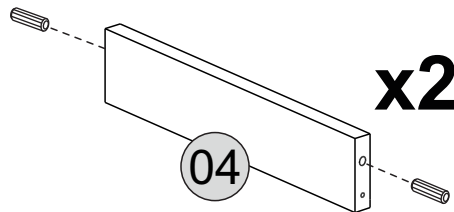
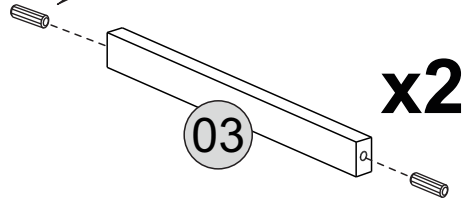

Please assemble on a clean soft surface to avoid damage.



Glue must be added to the dowel holes on parts 03 and 04.

# STEP 2

## PARTS REQUIRED

1 - FRONT LEG x2

3 - STRETCHER x2

4 - SIDE SEAT RAIL x2

5 - BACK LEG x2

## HARDWARE REQUIRED

A  01

B  Ø 7 x 80 04

G  4,0 x 40 04

## TOOLS REQUIRED

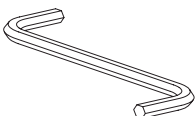

x2

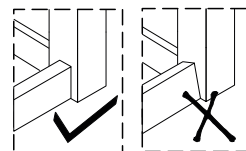
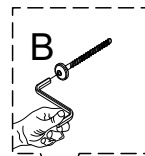

Ø 7 x 80



Ø 7 x 60

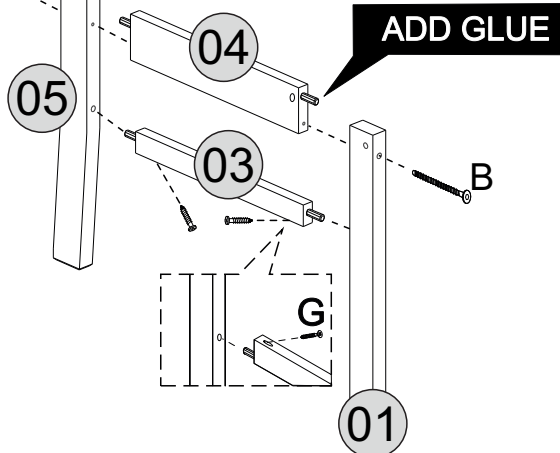

Please assemble on a clean soft surface to avoid damage.

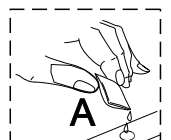

# STEP 3

## PARTS REQUIRED

2 - BACK/FRONT RAIL x2

7 - BACK RAIL x1

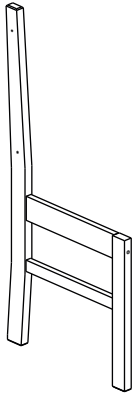

## HARDWARE REQUIRED

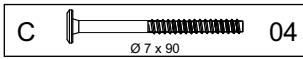

## TOOLS REQUIRED

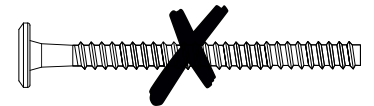
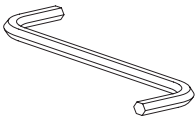

Ø 7 x 80



Ø 7 x 60

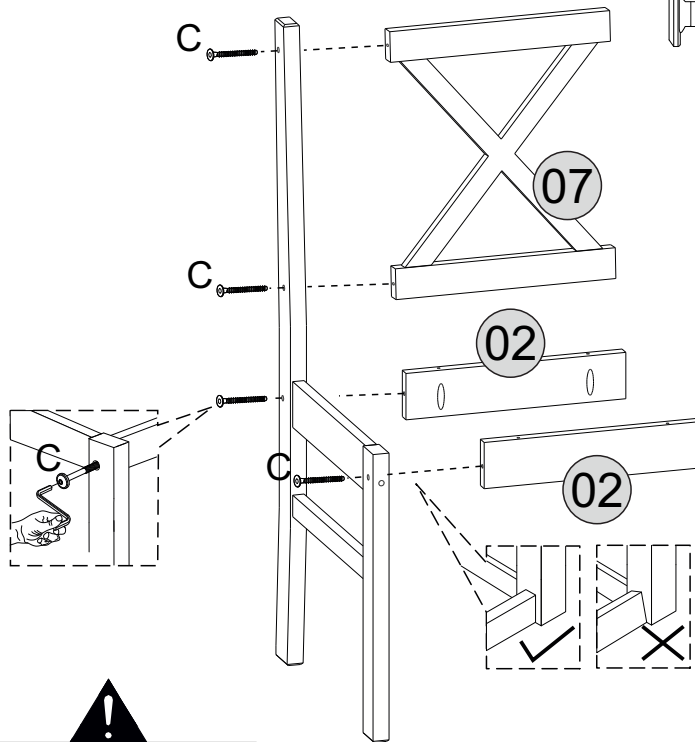

**Please assemble on a clean soft surface to avoid damage.**

# STEP 4

## PARTS REQUIRED

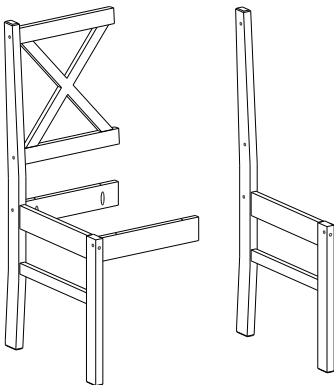

## HARDWARE REQUIRED

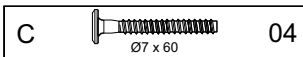

## TOOLS REQUIRED

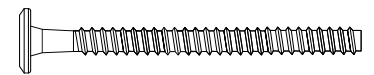
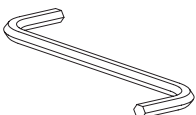

Ø 7 x 80



Ø 7 x 60

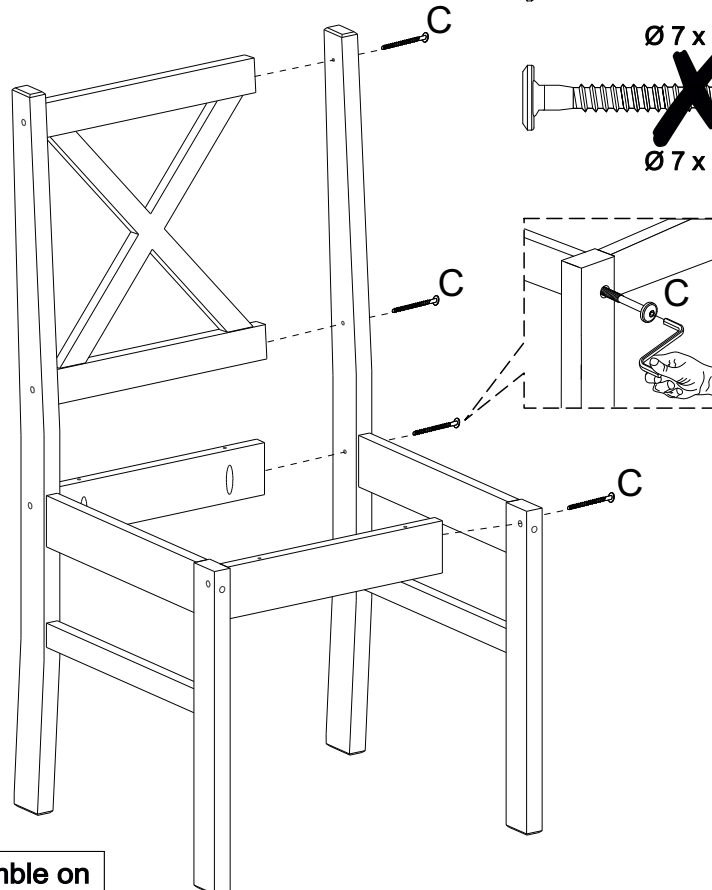

**Please assemble on a clean soft surface to avoid damage.**

# STEP 5

**PARTS REQUIRED**

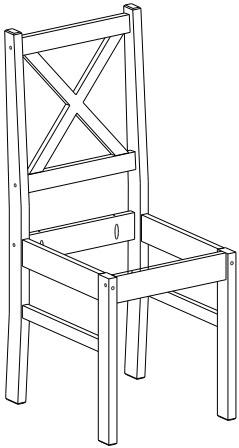

**HARDWARE REQUIRED**

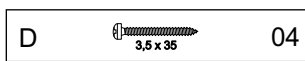

**TOOLS REQUIRED**

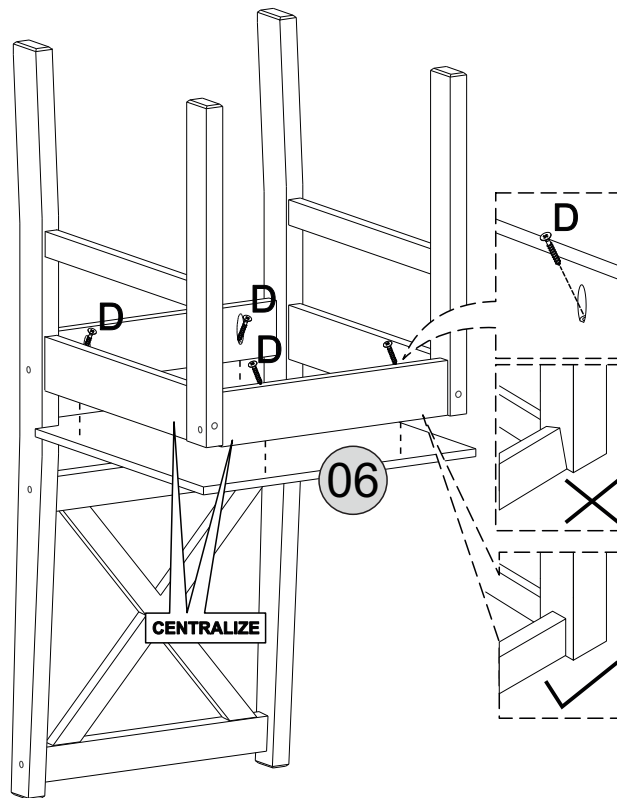
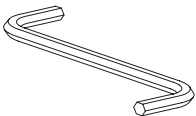

**!**  
Please assemble on a clean soft surface to avoid damage.

# STEP 6

**PARTS REQUIRED**

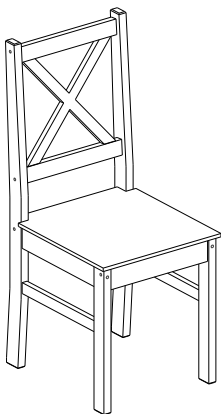

**HARDWARE REQUIRED**

**TOOLS REQUIRED**

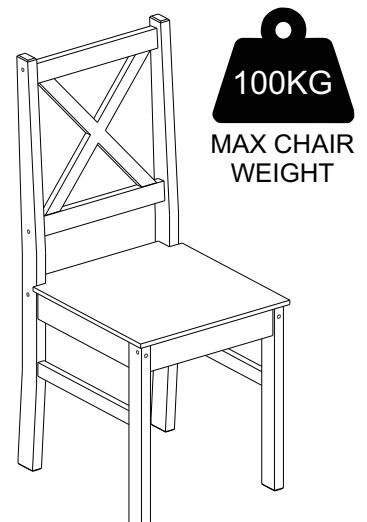
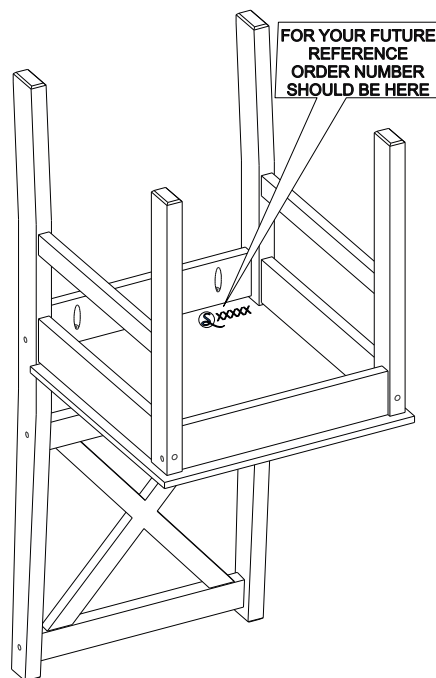

**!**  
Please assemble on a clean soft surface to avoid damage.

# GREY SALVADOR 1+2 TILE TOP DINING TABLE ASSEMBLY INSTRUCTIONS

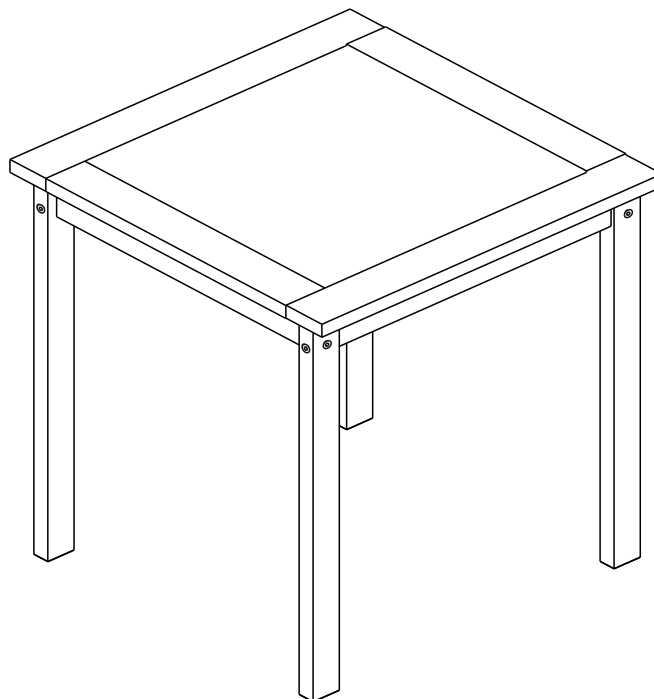
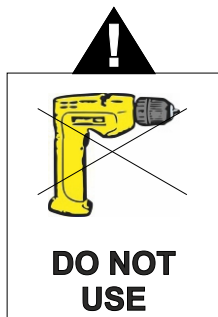

## IMPORTANT FOR DOMESTIC USE ONLY

PLEASE READ BEFORE YOU CONTINUE FURTHER

## CARE AND MAINTENANCE

After unpacking this product please keep the original packaging in case it needs to be returned for any reason.

- Please ensure all fittings and parts are present before commencing with assembly.
- We recommend that you lay a blanket or sheet on the floor to avoid damage to both your floor and the product.
- We strongly recommend that you keep children away from your work area.
- Assemble this product as close to its final position as possible.
- Never drag or push products as this could cause damage to the joints making it inferior.
- Do not place this product next to a radiator or in direct sunlight.
- Wood is a natural product and may expand if subjected to damp and may shrink or crack if subjected to heat. Therefore it is recommended that room temperature is maintained, with no sudden temperature fluctuations.
- Make sure any spillage is wiped off immediately.
- Do not place hot or chilled items directly on to the surface, use a place mat or marking will occur.
- For general cleaning use a duster, and do not use detergents of any kind. However, the surface will need to be retreated from time to time. This can be done by using block wax (unperfumed) and rubbing it over the whole item.
- From time to time it may be necessary to tighten fittings, regular inspections should be carried out.

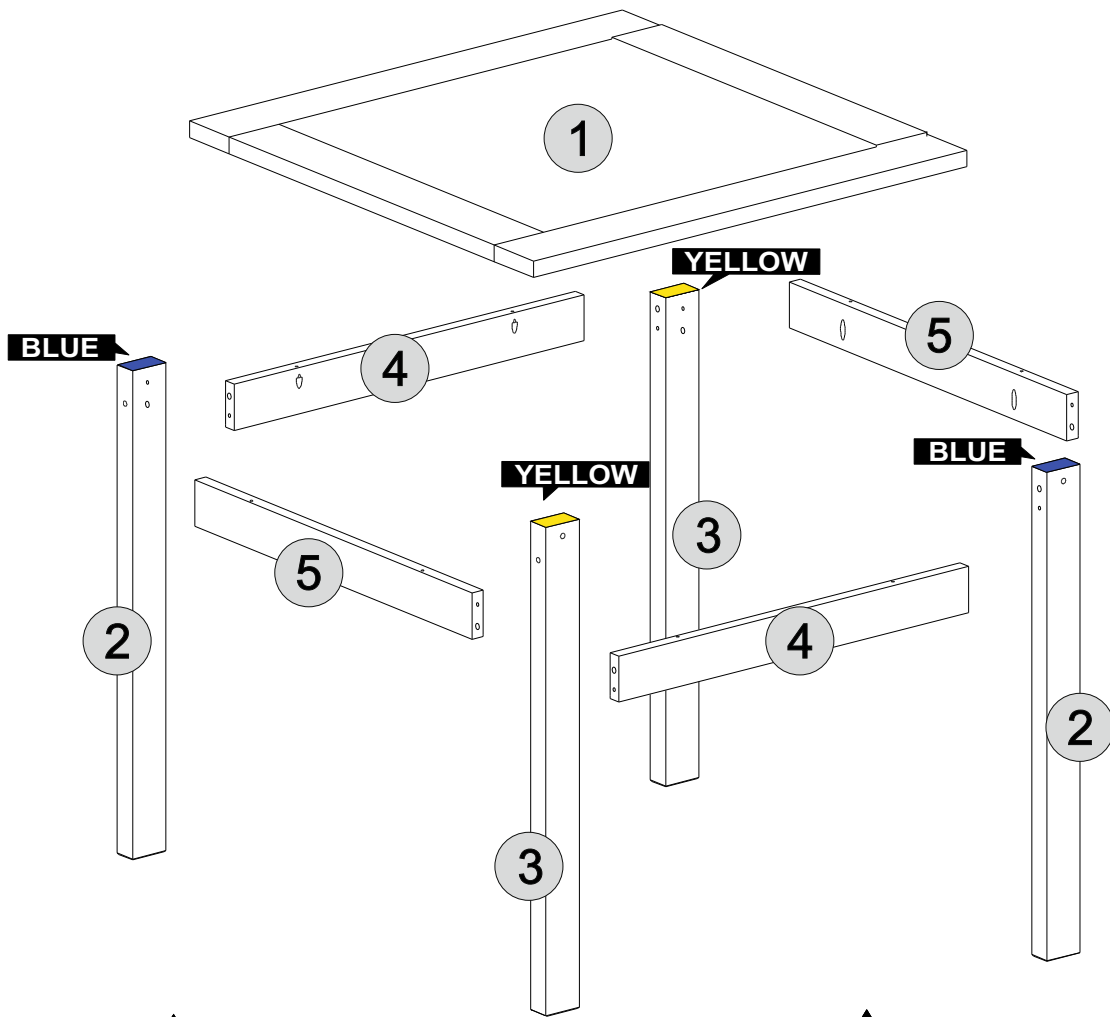

**!**

- \* Use of power tools to assemble this product will invalidate any claim and damage this product making it unsafe !!!
- \* Please assemble on a clean soft surface to avoid damage.

**!**

- \* Please check contents and read the instructions before commencing assembly.
- \* Assemble this product following the enclosed instructions carefully.
- \* Please take care to avoid damaging panels during assembly.







***Please Note:***  
 The below highlighted parts have been colour coded to help identify them during assembly.

### **PARTS LIST**

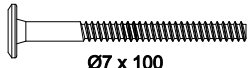
<b>Part Number</b>	<b>Part Code</b>	<b>Part Description</b>	<b>Quantity</b>	<b>Carton</b>
1	S400-401-172-KK1-01T	Table Top	1	1/1
2	S400-401-172-KK1-02T	Table Leg (Blue)	2	1/1
3	S400-401-172-KK1-03T	Table leg (Yellow)	2	1/1
4	S400-401-172-KK1-04T	Short Frame Side	2	1/1
5	S400-401-172-KK1-05T	Long Frame Side	2	1/1

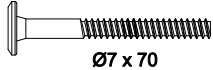

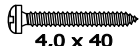
## FITTINGS

<b>A</b>	 Ø7 x 100	<b>04</b>	<b>D</b>	 GLUE	<b>01</b>
<b>B</b>	 Ø7 x 70	<b>04</b>	<b>E</b>		<b>01</b>
<b>C</b>	 4,0 x 40	<b>08</b>	<b>F</b>	 10 x 40	<b>08</b>

## TOOLS REQUIRED

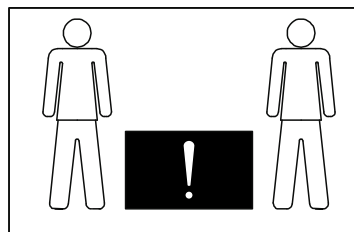
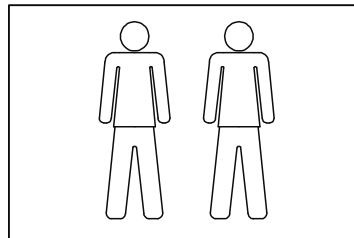
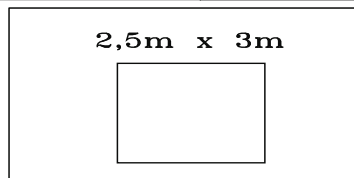
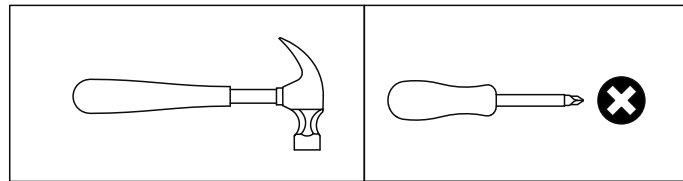

# STEP 1

## PARTS REQUIRED

4 - SHORT FRAME SIDE x2

5 - LONG FRAME SIDE x2

## HARDWARE REQUIRED

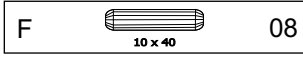

## TOOLS REQUIRED

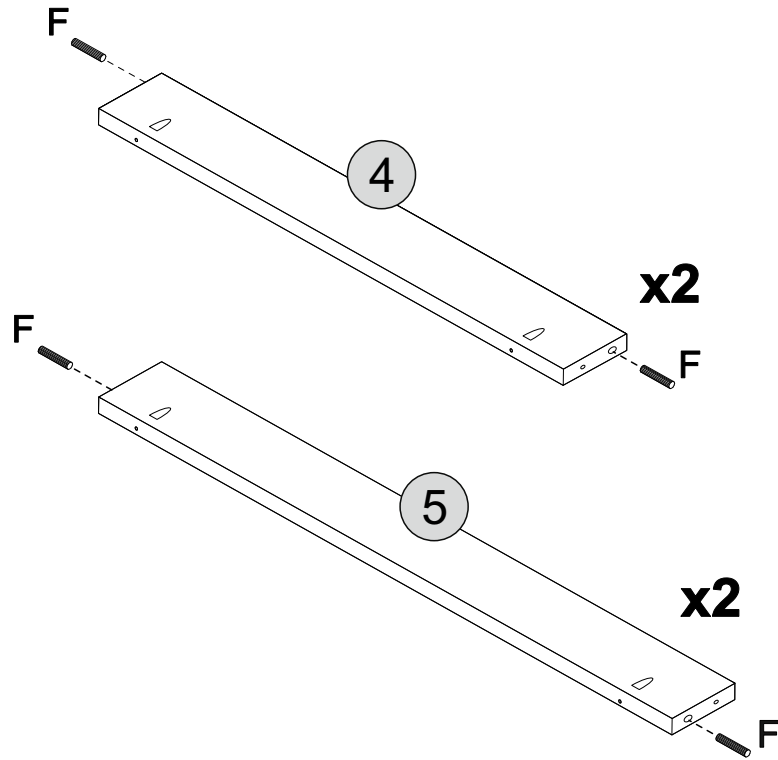

**!**  
Please assemble on a clean soft surface to avoid damage.

**!**  
Glue must be added to the dowel holes on parts 4 and 5.

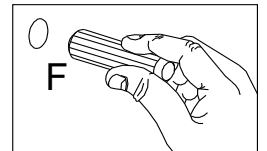

# STEP 2

## PARTS REQUIRED

2 - TABLE LEG (BLUE) x2

3 - TABLE LEG (YELLOW) x2

4 - SHORT FRAME SIDE x2

## HARDWARE REQUIRED

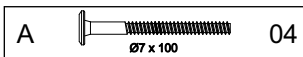

## TOOLS REQUIRED

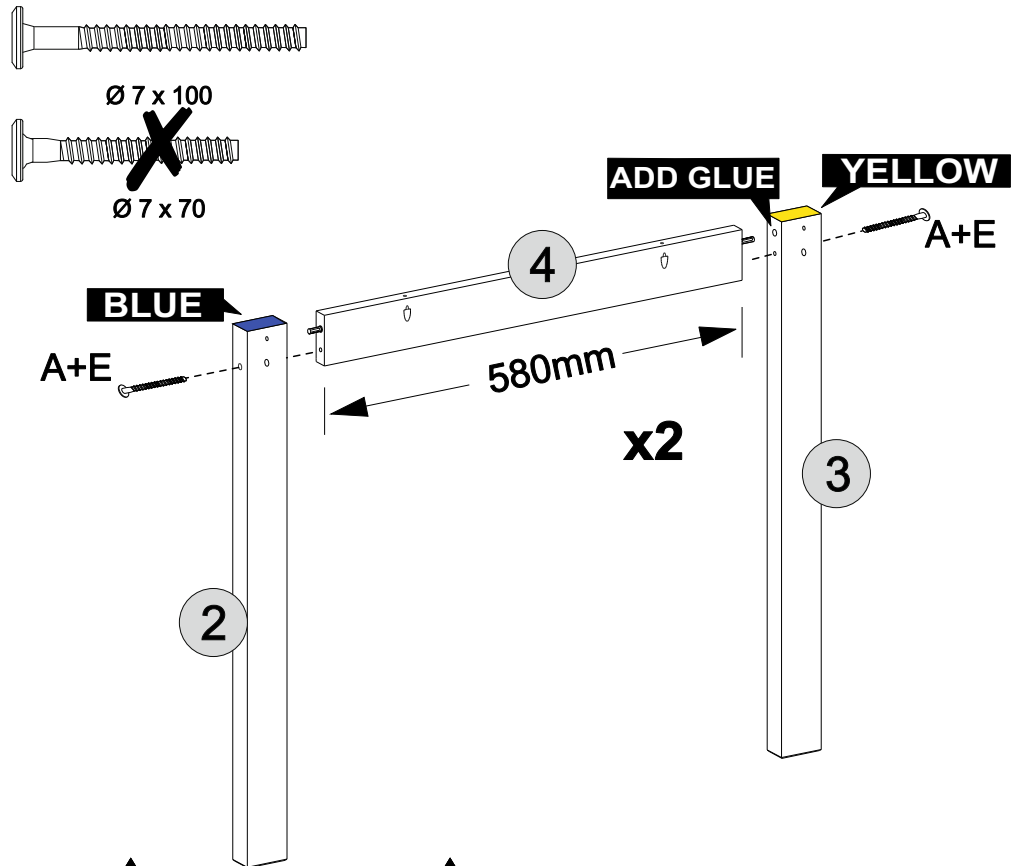
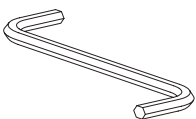

**!**  
Please assemble on a clean soft surface to avoid damage.

**!**  
Glue must be added to the dowel holes on parts 2 and 3.

# STEP 3

## PARTS REQUIRED

5 - LONG FRAME SIDE x2

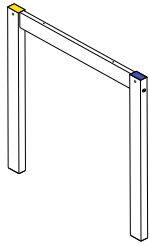

## HARDWARE REQUIRED

B  02  
Ø7 x 70

D  01  
GLUE

## TOOLS REQUIRED

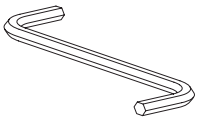

Ø7 x 100

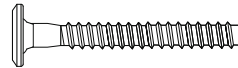

Ø7 x 70

**YELLOW**

B+E

5

**ADD GLUE**

5

B+E

**BLUE**



Please assemble on a clean soft surface to avoid damage.



Glue must be added to the dowel holes on parts 2 and 3.

# STEP 4

## PARTS REQUIRED

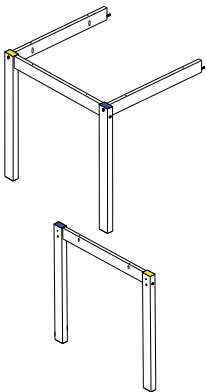

## HARDWARE REQUIRED

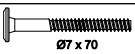
B  02  
Ø7 x 70

D  01  
GLUE

## TOOLS REQUIRED

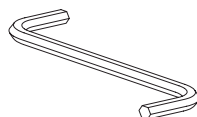

Ø7 x 100



Ø7 x 70

**BLUE**

B+E

**ADD GLUE**

B+E

**YELLOW**



Please assemble on a clean soft surface to avoid damage.



Glue must be added to the dowel holes on parts 2 and 3.

# STEP 5

PARTS REQUIRED

1 - TABLE TOP x1

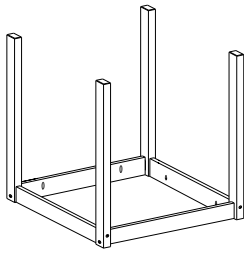

HARDWARE REQUIRED

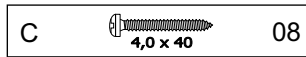

TOOLS REQUIRED

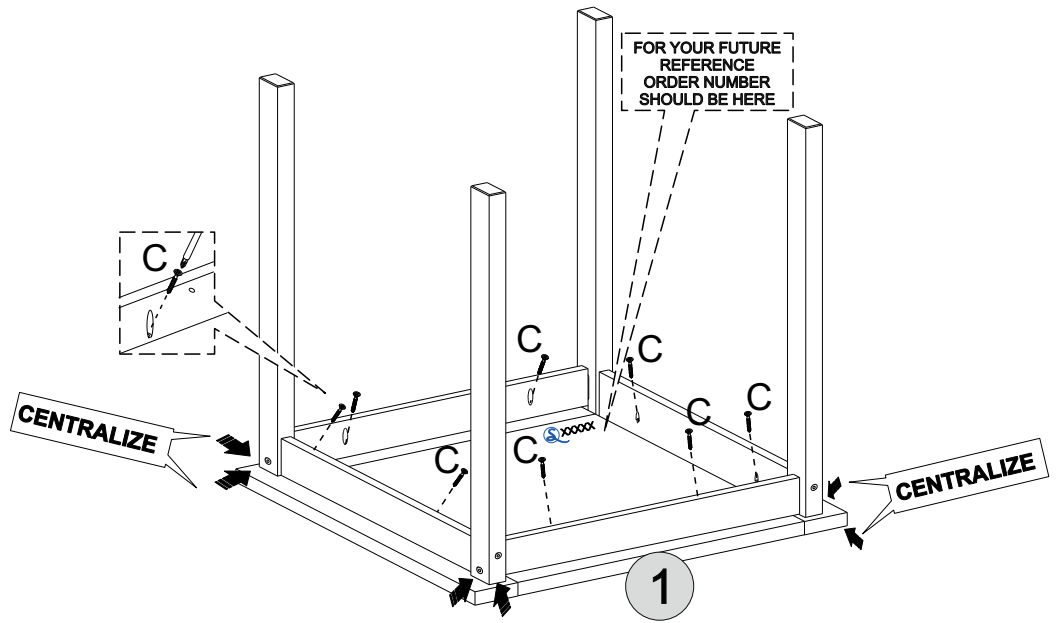
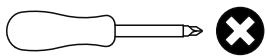

**!**  
Please assemble on a clean soft surface to avoid damage.

# STEP 6

PARTS REQUIRED

HARDWARE REQUIRED

TOOLS REQUIRED

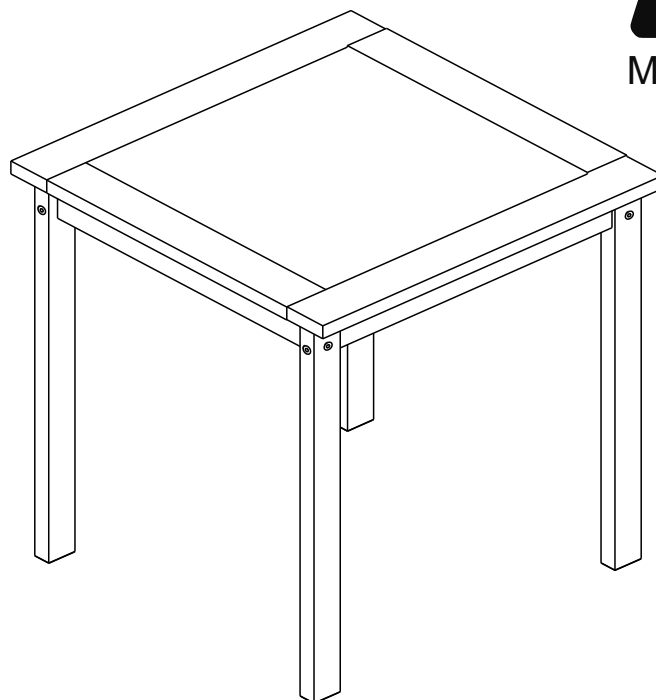

**40KG**  
MAX TABLE WEIGHT