

# SHELDON ROUND GLASS TOP DINING TABLE ASSEMBLY INSTRUCTIONS

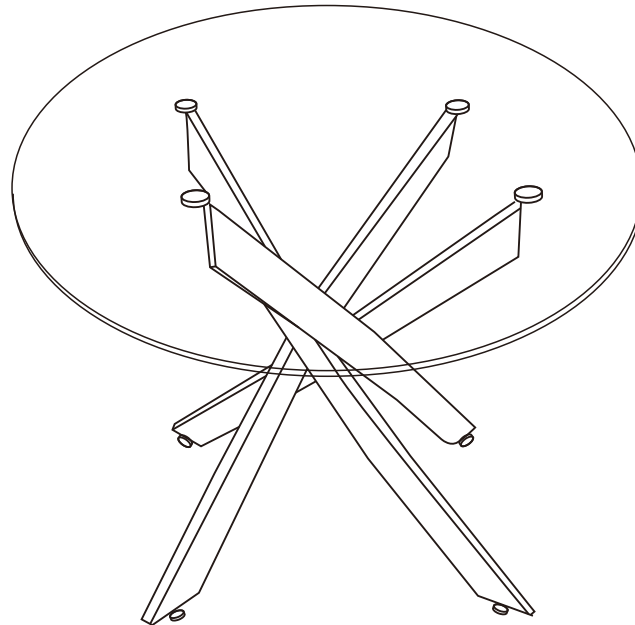

## **IMPORTANT FOR DOMESTIC USE ONLY PLEASE READ BEFORE YOU CONTINUE FURTHER**

THE PRODUCT YOU HAVE PURCHASED WILL GIVE YOU MANY YEARS OF SERVICE IF YOU FOLLOW THE GUIDELINES FOR ITS SAFE ASSEMBLY AND PERIODIC MAINTENANCE AND CLEANING .

ASSEMBLE ON A SOFT CLEAN SURFACE

DO NOT USE ANY TOOLS OTHER THAN THOSE SHOWN.

ANY SPANNERS OR ALLEN KEYS REQUIRED ARE INCLUDED WITH THE FITTINGS KIT.

DO NOT FOR ANY REASON USE A POWER TOOL TO ASSEMBLE THIS PRODUCT. ITS USE WILL INVALIDATE ANY CLAIM YOU MAY HAVE AND COULD MAKE THIS PRODUCT UNSAFE.

DEPENDING ON THE AMOUNT OF USE THIS PRODUCT RECEIVES IT MAY BE NECESSARY TO TIGHTEN UP THE FIXINGS FROM TIME TO TIME . THIS IS COMPLETELY NORMAL FOR ANY FLAT PACK FURNITURE.

DO NOT OVERTIGHTEN FIXINGS.

FOR CLEANING, YOU MAY USE A DAMP CLOTH (NOT WET) DO NOT USE POLISH, DETERGENT OR CHEMICAL CLEANERS.

THIS PRODUCT MAY STAIN OR MARK IF ALLOWED TO COME INTO CONTACT WITH WET OR DAMP OBJECTS.

THE SURFACE OF THIS ITEM IS NOT HEAT RESISTANT. ALWAYS USE A PLACE MAT UNDER HOT OR COLD ITEMS TO PREVENT MARKING.

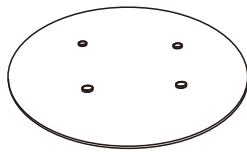

1

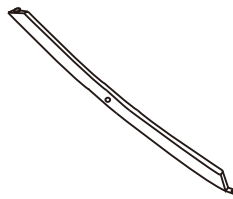

2

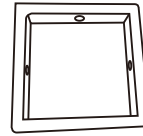





3

## **PARTS LIST**

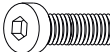
<b>Part Number</b>	<b>Part Code</b>	<b>Part Description</b>	<b>Quantity</b>	<b>Carton</b>
1	S400-403-067-LY1-01	Table Top	1	1/2
2	S400-403-067-LY1-02	Table Leg	4	2/2
3	S400-403-067-LY1-03	Metal Leg Support	1	2/2

## **HARDWARE LIST**

<b>REF</b>		<b>HARDWARE NAME</b>	<b>QTY</b>
<b>A</b>		Bolt M8 x 10mm	4 PCS
<b>B</b>		Bolt M8 x 16mm	4 PCS
<b>C</b>		Metal Washer	4 PCS
<b>D</b>		Allen Key M5	1 PC
<b>E</b>		Allen Key M6	1 PC
<b>F</b>		Adjusting Foot	4 PCS

**PLEASE CHECK THAT YOU HAVE ALL THE PARTS LISTED BEFORE YOU START ASSEMBLING. IF YOU DO FIND THAT SOMETHING IS MISSING, DO NOT CONTINUE ASSEMBLY. PLEASE CONTACT YOUR SUPPLIER IMMEDIATELY.**

# STEP 1

## PARTS REQUIRED

2 - TABLE LEG x2

3 - METAL LEG SUPPORT x1

## HARDWARE REQUIRED

B  02

## TOOLS REQUIRED

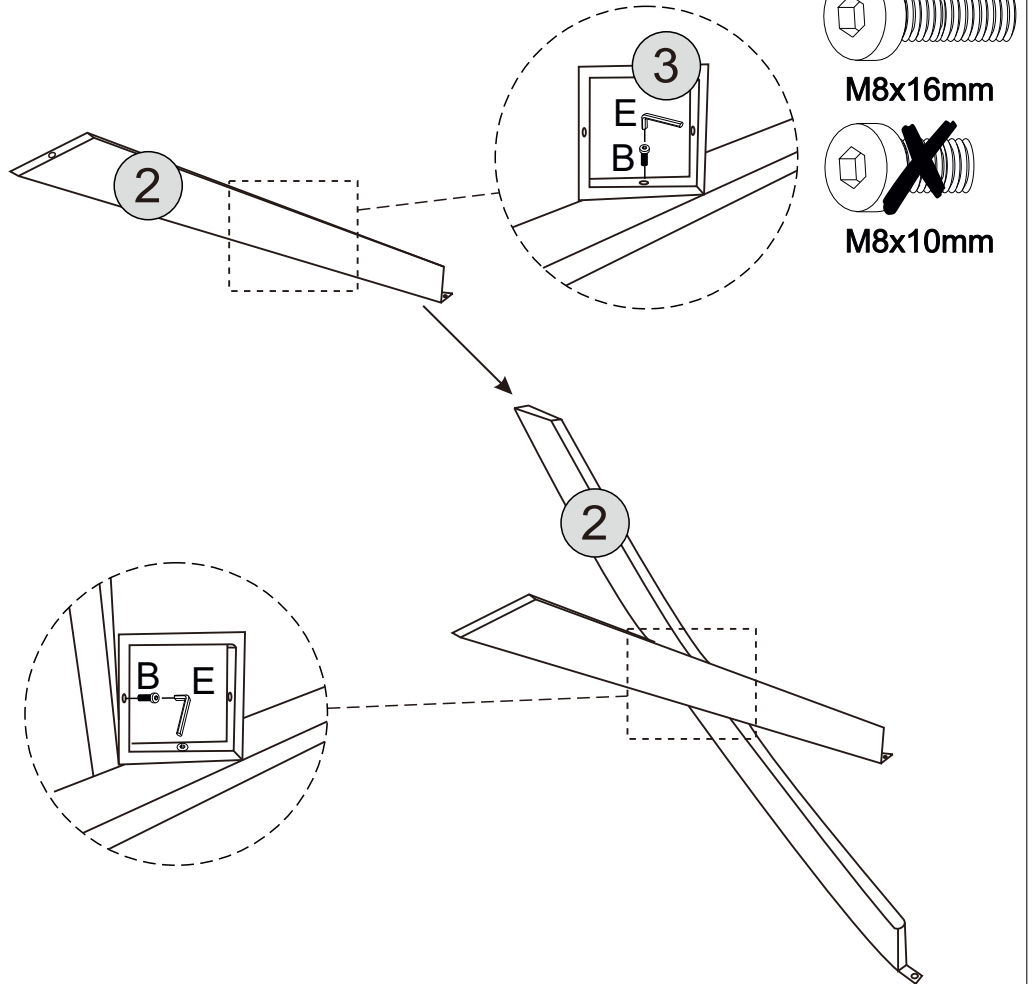
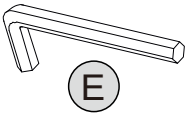

# STEP 2

## PARTS REQUIRED

2 - TABLE LEG x2

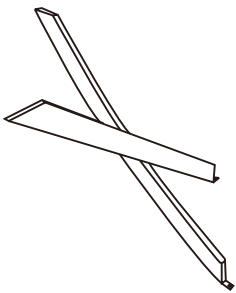

## HARDWARE REQUIRED

B  02

## TOOLS REQUIRED

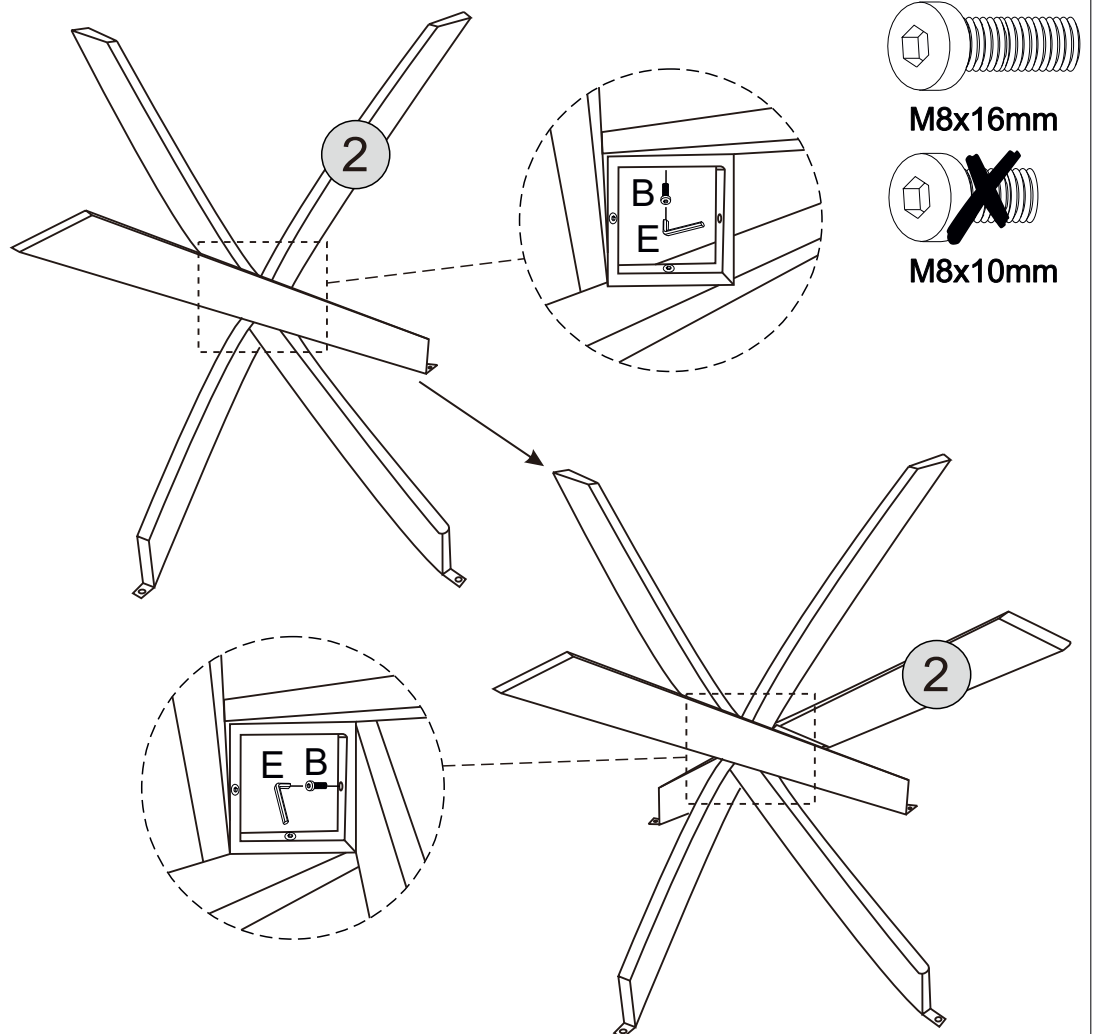
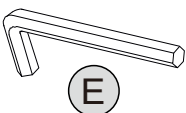

# STEP 3

## PARTS REQUIRED

1 - TABLE TOP x1

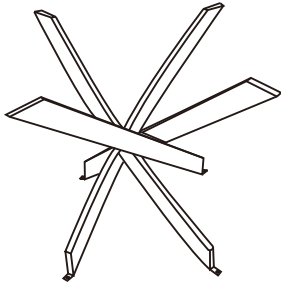

## HARDWARE REQUIRED

A  04

C  04

## TOOLS REQUIRED

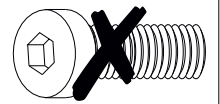
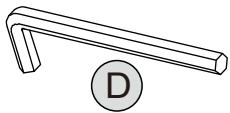

M8x16mm

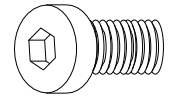

M8x10mm

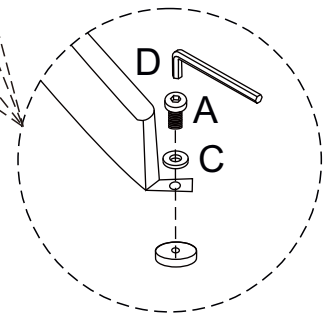
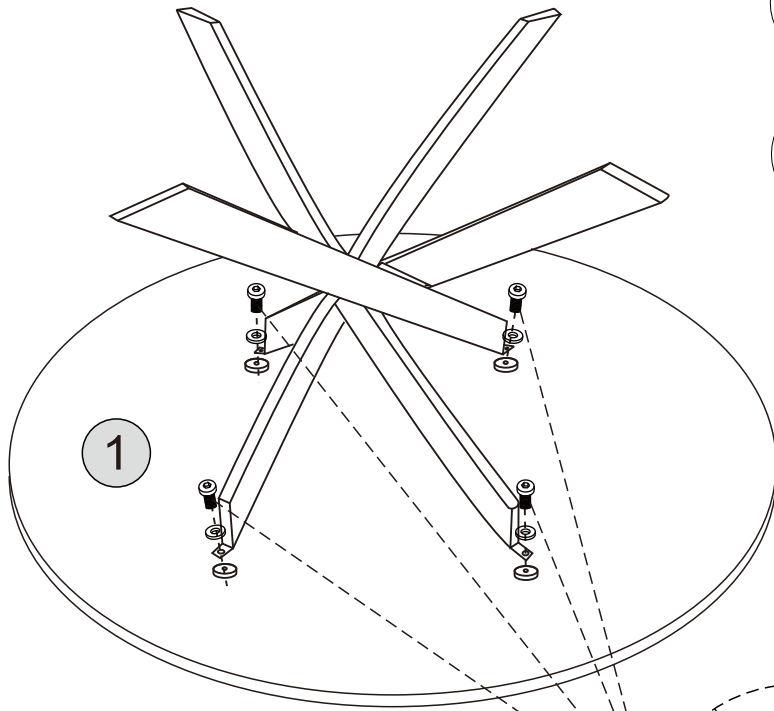

# STEP 4

## PARTS REQUIRED

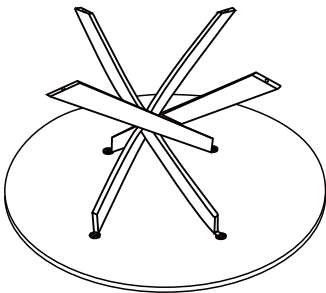

## HARDWARE REQUIRED

F  04

## TOOLS REQUIRED

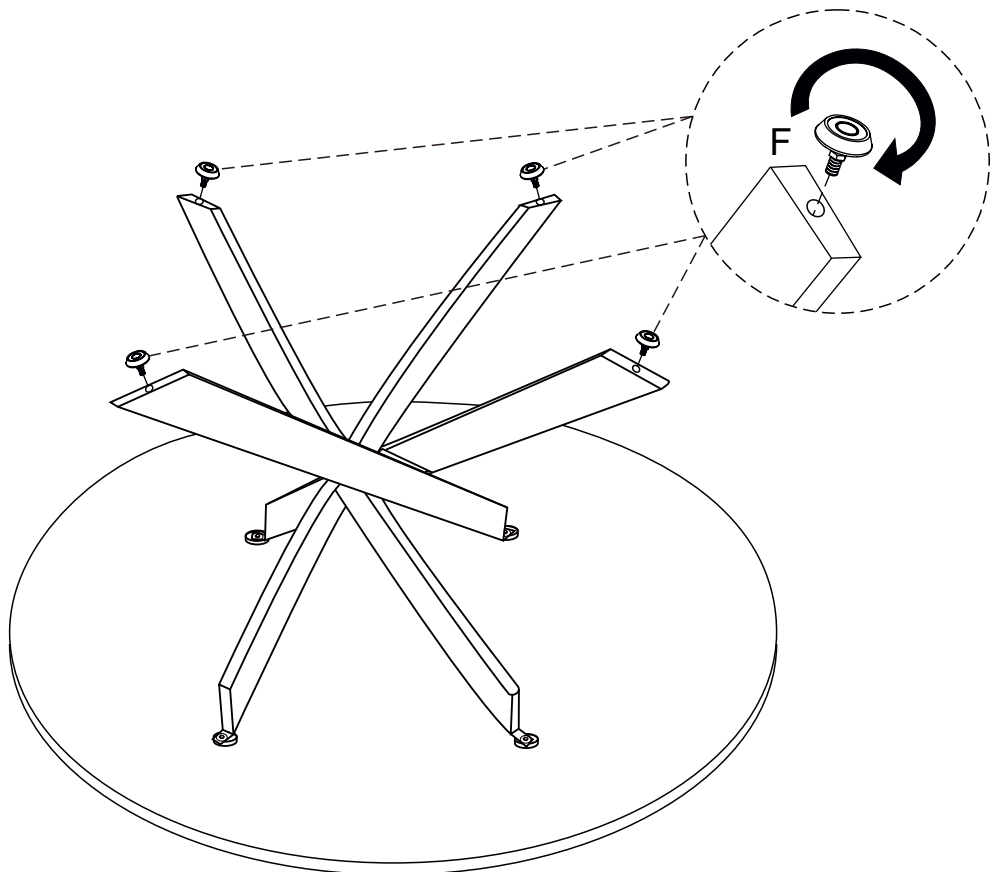

# SHELDON DINING CHAIR ASSEMBLY INSTRUCTIONS

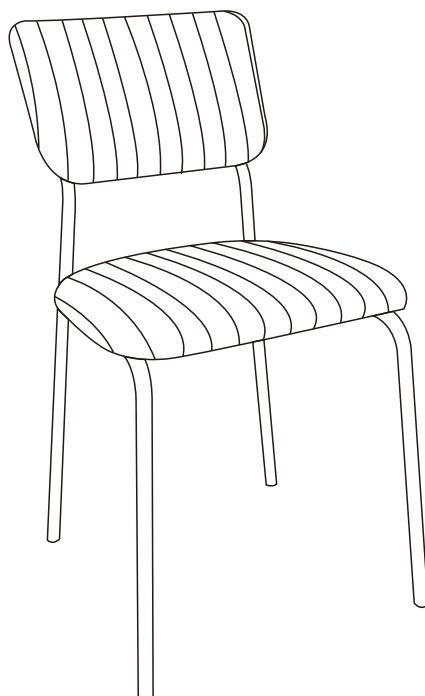

## **IMPORTANT FOR DOMESTIC USE ONLY PLEASE READ BEFORE YOU CONTINUE FURTHER**

THE PRODUCT YOU HAVE PURCHASED WILL GIVE YOU MANY YEARS OF SERVICE IF YOU FOLLOW THE GUIDELINES FOR ITS SAFE ASSEMBLY AND PERIODIC MAINTENANCE AND CLEANING .

ASSEMBLE ON A SOFT CLEAN SURFACE

DO NOT USE ANY TOOLS OTHER THAN THOSE SHOWN.

ANY SPANNERS OR ALLEN KEYS REQUIRED ARE INCLUDED WITH THE FITTINGS KIT.

DO NOT FOR ANY REASON USE A POWER TOOL TO ASSEMBLE THIS PRODUCT. ITS USE WILL INVALIDATE ANY CLAIM YOU MAY HAVE AND COULD MAKE THIS PRODUCT UNSAFE.

DEPENDING ON THE AMOUNT OF USE THIS PRODUCT RECEIVES IT MAY BE NECESSARY TO TIGHTEN UP THE FIXINGS FROM TIME TO TIME . THIS IS COMPLETELY NORMAL FOR ANY FLAT PACK FURNITURE.  
DO NOT OVERTIGHTEN FIXINGS.

FOR CLEANING, YOU MAY USE A DAMP CLOTH (NOT WET) DO NOT USE POLISH, DETERGENT OR CHEMICAL CLEANERS.

THIS PRODUCT MAY STAIN OR MARK IF ALLOWED TO COME INTO CONTACT WITH WET OR DAMP OBJECTS.

THE SURFACE OF THIS ITEM IS NOT HEAT RESISTANT. ALWAYS USE A PLACE MAT UNDER HOT OR COLD ITEMS TO PREVENT MARKING.

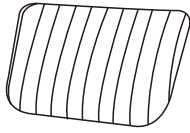

1

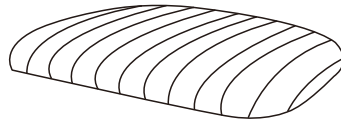

2

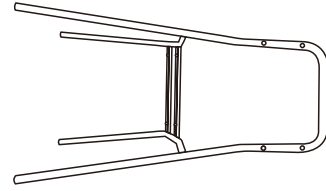

3

## PARTS LIST

Part Number	Part Description	Quantity	Carton
1	Chair Back	1	1/1
2	Chair Seat	1	1/1
3	Chair Leg	1	1/1

## HARDWARE LIST

REF		HARDWARE NAME	QTY
A		Bolts M6×35mm	4PCS
B		Bolts M6×30mm	4PCS
C		Allen Key	1PC

PLEASE CHECK THAT YOU HAVE ALL THE PARTS LISTED BEFORE YOU START ASSEMBLING. IF YOU DO FIND THAT SOMETHING IS MISSING, DO NOT CONTINUE ASSEMBLY. PLEASE CONTACT YOUR SUPPLIER IMMEDIATELY.

# STEP 1

## PARTS REQUIRED

2 - CHAIR SEAT x1

3 - CHAIR LEG x1

## HARDWARE REQUIRED

B  04

## TOOLS REQUIRED

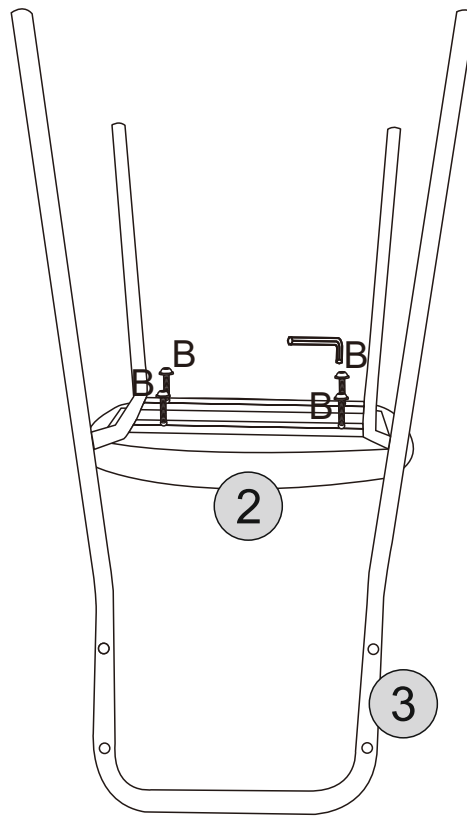

M6 x 35mm

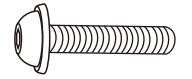

M6 x 30mm

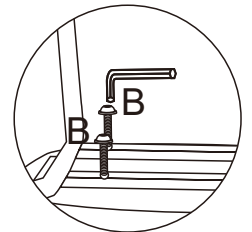

# STEP 2

## PARTS REQUIRED

1 - CHAIR BACK x1



## HARDWARE REQUIRED

A  04

## TOOLS REQUIRED

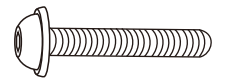
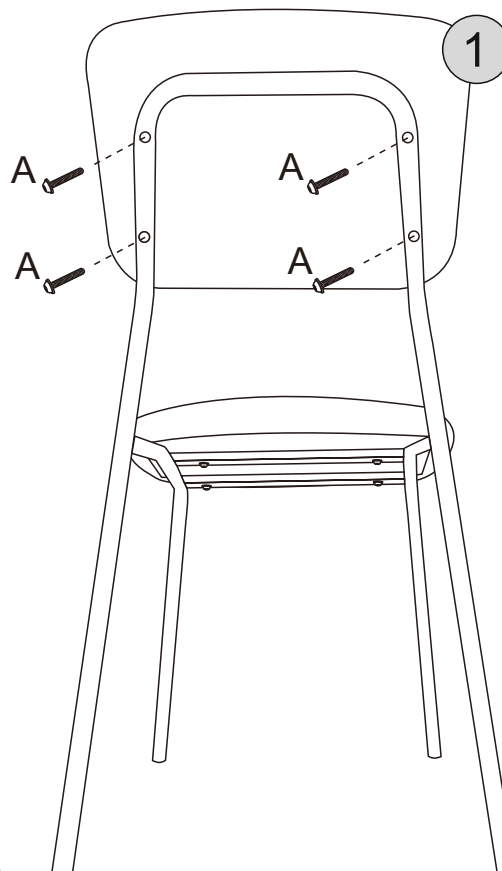

M6 x 35mm



M6 x 30mm

