

HAMILTON MEDIUM DINING TABLE ASSEMBLY INSTRUCTIONS



FOR DOMESTIC USE ONLY
IMPORTANT

PLEASE READ BEFORE YOU CONTINUE FURTHER

THE PRODUCT YOU HAVE PURCHASED WILL GIVE YOU MANY YEARS OF SERVICE IF YOU FOLLOW THE GUIDELINES FOR ITS SAFE ASSEMBLY AND PERIODIC MAINTENANCE AND CLEANING .

ASSEMBLE ON A SOFT CLEAN SURFACE

DO NOT USE ANY TOOLS OTHER THAN THOSE SHOWN.

ANY SPANNERS OR ALLEN KEYS REQUIRED ARE INCLUDED WITH THE FITTINGS KIT.

DO NOT FOR ANY REASON USE A POWER TOOL TO ASSEMBLE THIS PRODUCT. ITS USE WILL INVALIDATE ANY CLAIM YOU MAY HAVE AND COULD MAKE THIS PRODUCT UNSAFE.

DEPENDING ON THE AMOUNT OF USE THIS PRODUCT RECEIVES IT MAY BE NECESSARY TO TIGHTEN UP THE FIXINGS FROM TIME TO TIME . THIS IS COMPLETELY NORMAL FOR ANY FLAT PACK FURNITURE.
DO NOT OVERTIGHTEN FIXINGS.

FOR CLEANING, YOU MAY USE A DAMP CLOTH (NOT WET) DO NOT USE POLISH, DETERGENT OR CHEMICAL CLEANERS.

THIS PRODUCT MAY STAIN OR MARK IF ALLOWED TO COME INTO CONTACT WITH WET OR DAMP OBJECTS.

THE SURFACE OF THIS ITEM IS NOT HEAT RESISTANT. ALWAYS USE A PLACE MAT UNDER HOT OR COLD ITEMS TO PREVENT MARKING.

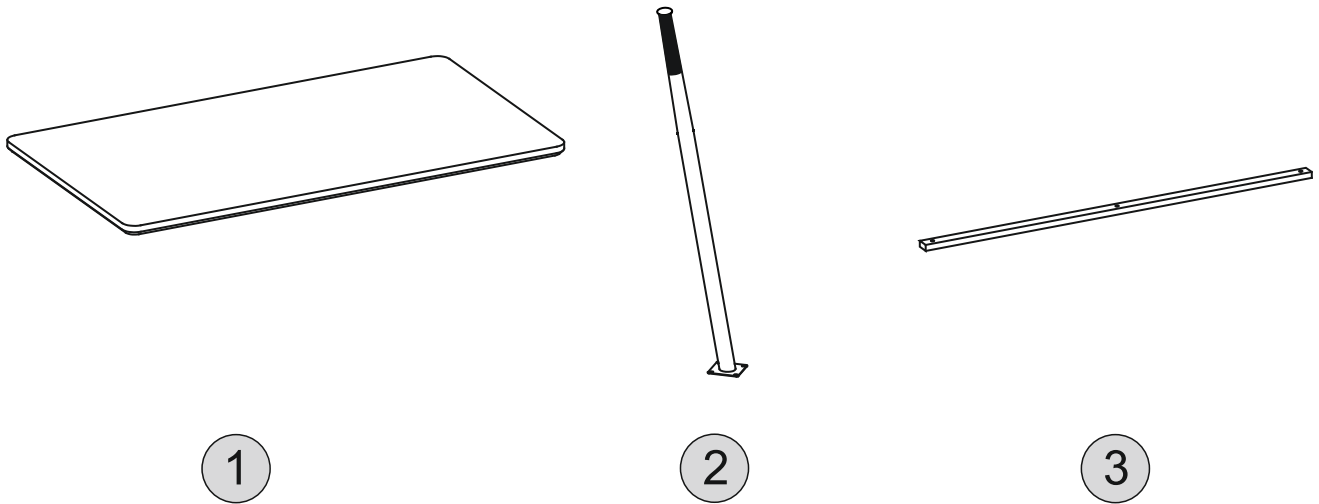

PARTS LIST

Part Number	Part Code	Part Description	Quantity	Carton
1	S400-403-069-SF1-01	Table Top	1	1/2
2	S400-403-069-SF1-02	Table Leg	4	2/2
3	S400-403-069-SF1-03	Support Bar	2	2/2

HARDWARE LIST

REF		HARDWARE NAME	QTY
A		Bolts M8x16mm	16PCS
B		Bolts M8x30mm	6PCS
C		Metal Washer	22PCS
D		Allen Key	1PC

PLEASE CHECK THAT YOU HAVE ALL THE PARTS LISTED BEFORE YOU START ASSEMBLING. IF YOU DO FIND THAT SOMETHING IS MISSING. DO NOT CONTINUE ASSEMBLY. PLEASE CONTACT YOUR SUPPLIER IMMEDIATELY.

STEP 1

PARTS REQUIRED

1 - TABLE TOP x1

2 - TABLE LEG x4

HARDWARE REQUIRED

A  16

C  16

TOOLS REQUIRED

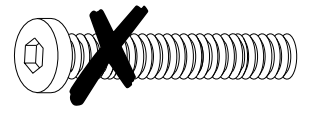

M8x30mm

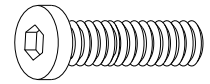

M8x16mm

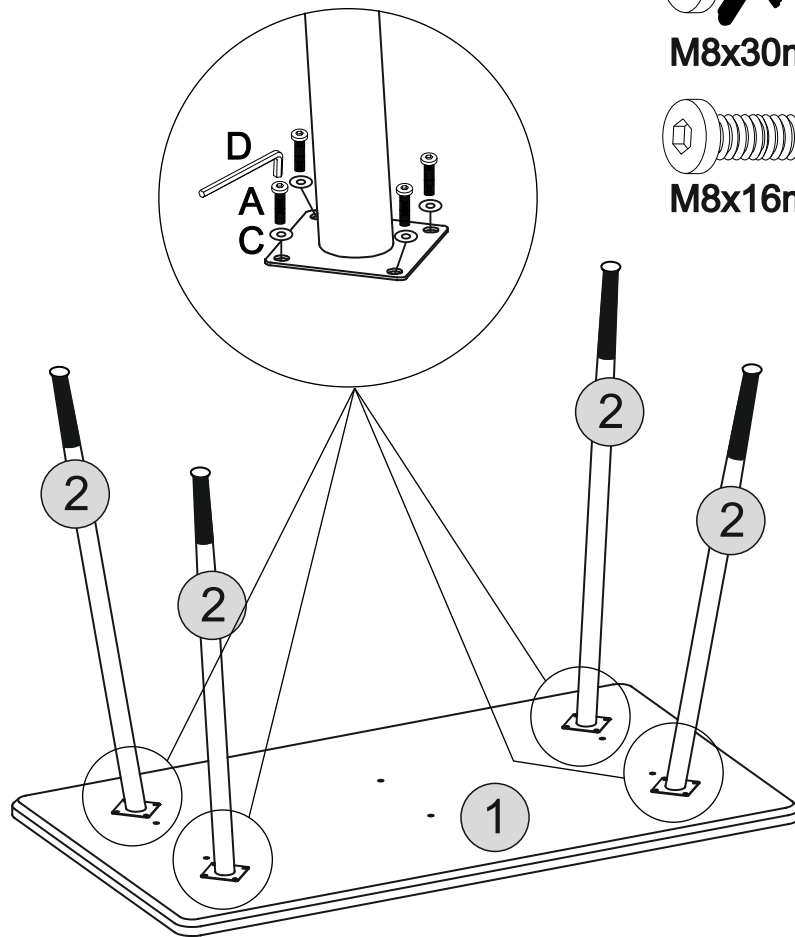

STEP 2

PARTS REQUIRED

3 - SUPPORT BAR x2

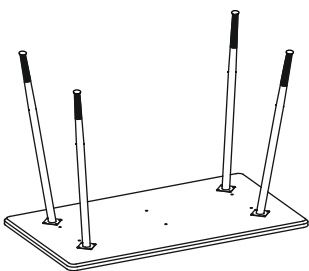

HARDWARE REQUIRED

B  06

C  06

TOOLS REQUIRED

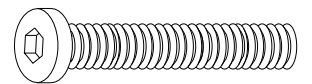
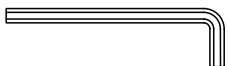

M8x30mm

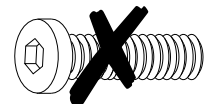

M8x16mm

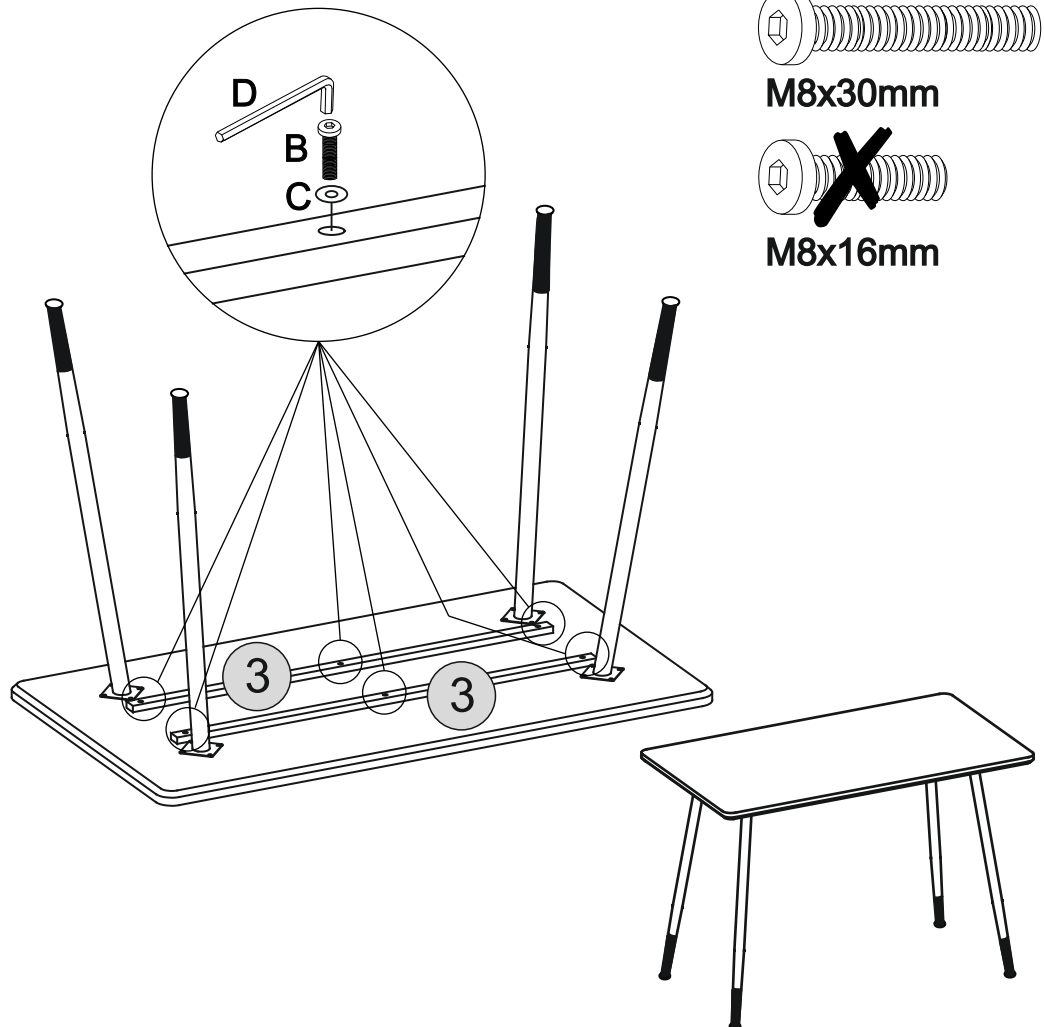

AVERY DINING CHAIR ASSEMBLY INSTRUCTIONS

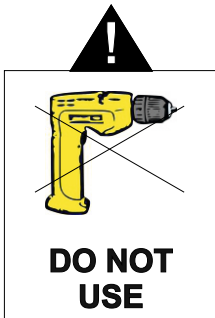

**MAX CHAIR
WEIGHT**

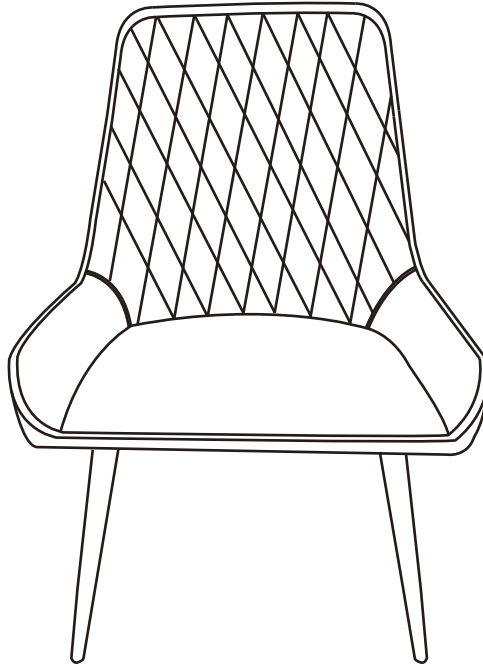

**IMPORTANT
FOR DOMESTIC USE ONLY
PLEASE READ BEFORE YOU CONTINUE FURTHER**

THE PRODUCT YOU HAVE PURCHASED WILL GIVE YOU MANY YEARS OF SERVICE IF YOU FOLLOW THE GUIDELINES FOR ITS SAFE ASSEMBLY AND PERIODIC MAINTENANCE AND CLEANING .

ASSEMBLE ON A SOFT CLEAN SURFACE

DO NOT USE ANY TOOLS OTHER THAN THOSE SHOWN.

ANY SPANNERS OR ALLEN KEYS REQUIRED ARE INCLUDED WITH THE FITTINGS KIT.

DO NOT FOR ANY REASON USE A POWER TOOL TO ASSEMBLE THIS PRODUCT. ITS USE WILL INVALIDATE ANY CLAIM YOU MAY HAVE AND COULD MAKE THIS PRODUCT UNSAFE.

DEPENDING ON THE AMOUNT OF USE THIS PRODUCT RECEIVES IT MAY BE NECESSARY TO TIGHTEN UP THE FIXINGS FROM TIME TO TIME . THIS IS COMPLETELY NORMAL FOR ANY FLAT PACK FURNITURE.

DO NOT OVERTIGHTEN FIXINGS.

FOR CLEANING, YOU MAY USE A DAMP CLOTH (NOT WET) DO NOT USE POLISH, DETERGENT OR CHEMICAL CLEANERS.

THIS PRODUCT MAY STAIN OR MARK IF ALLOWED TO COME INTO CONTACT WITH WET OR DAMP OBJECTS.

THE SURFACE OF THIS ITEM IS NOT HEAT RESISTANT. ALWAYS USE A PLACE MAT UNDER HOT OR COLD ITEMS TO PREVENT MARKING.

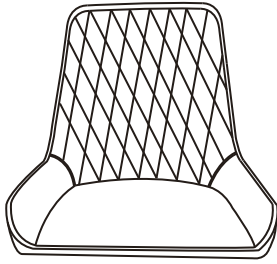

1

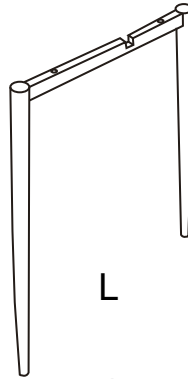

L

2

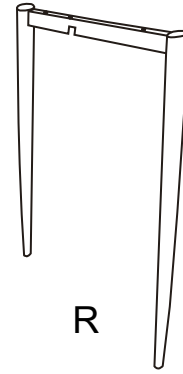

R

3

PARTS LIST

Part Number	Part Description	Quantity	Carton
1	Seat Pad	1	1/1
2	Chair Leg (L)	1	1/1
3	Chair Leg (R)	1	1/1

HARDWARE LIST

REF		HARDWARE NAME	QTY
A		Bolts M6x30mm	1PCS
B		Bolts M6x45mm	4PCS
C		Metal Washer	5PCS
D		Allen Key	1PC

PLEASE CHECK THAT YOU HAVE ALL THE PARTS LISTED BEFORE YOU START ASSEMBLING. IF YOU DO FIND THAT SOMETHING IS MISSING, DO NOT CONTINUE ASSEMBLY. PLEASE CONTACT YOUR SUPPLIER IMMEDIATELY.

STEP 1

PARTS REQUIRED

2 - CHAIR LEG (L) x1

3 - CHAIR LEG (R) x1

HARDWARE REQUIRED

A  01

C  01

TOOLS REQUIRED

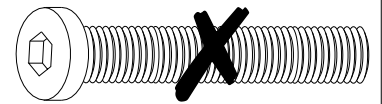

M6x45mm

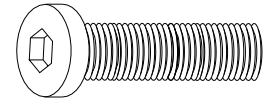

M6x30mm

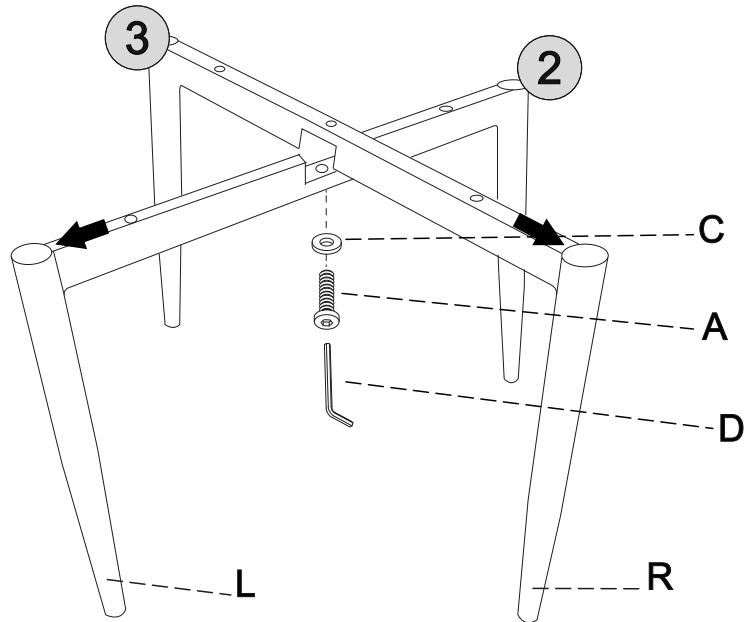

STEP 2

PARTS REQUIRED

3 - SEAT PAD x1

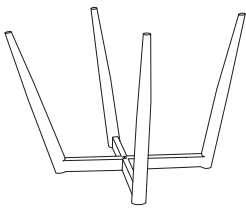

HARDWARE REQUIRED

B  04

C  04

TOOLS REQUIRED

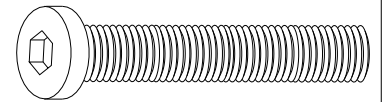
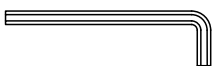

M6x45mm

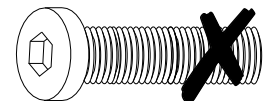

M6x30mm

