

SHELDON ROUND WOODEN TOP DINING TABLE ASSEMBLY INSTRUCTIONS



IMPORTANT FOR DOMESTIC USE ONLY PLEASE READ BEFORE YOU CONTINUE FURTHER

THE PRODUCT YOU HAVE PURCHASED WILL GIVE YOU MANY YEARS OF SERVICE IF YOU FOLLOW THE GUIDELINES FOR ITS SAFE ASSEMBLY AND PERIODIC MAINTENANCE AND CLEANING .

ASSEMBLE ON A SOFT CLEAN SURFACE

DO NOT USE ANY TOOLS OTHER THAN THOSE SHOWN.

ANY SPANNERS OR ALLEN KEYS REQUIRED ARE INCLUDED WITH THE FITTINGS KIT.

DO NOT FOR ANY REASON USE A POWER TOOL TO ASSEMBLE THIS PRODUCT. ITS USE WILL INVALIDATE ANY CLAIM YOU MAY HAVE AND COULD MAKE THIS PRODUCT UNSAFE.

DEPENDING ON THE AMOUNT OF USE THIS PRODUCT RECEIVES IT MAY BE NECESSARY TO TIGHTEN UP THE FIXINGS FROM TIME TO TIME . THIS IS COMPLETELY NORMAL FOR ANY FLAT PACK FURNITURE.
DO NOT OVERTIGHTEN FIXINGS.

FOR CLEANING, YOU MAY USE A DAMP CLOTH (NOT WET) DO NOT USE POLISH, DETERGENT OR CHEMICAL CLEANERS.

THIS PRODUCT MAY STAIN OR MARK IF ALLOWED TO COME INTO CONTACT WITH WET OR DAMP OBJECTS.

THE SURFACE OF THIS ITEM IS NOT HEAT RESISTANT. ALWAYS USE A PLACE MAT UNDER HOT OR COLD ITEMS TO PREVENT MARKING.

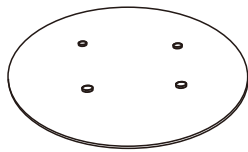

1

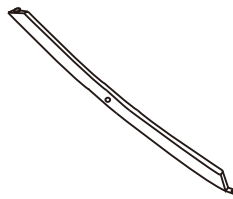

2

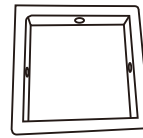

3

PARTS LIST

Part Number	Part Code	Part Description	Quantity	Carton
1	S400-403-066-LY1-01	Table Top	1	1/2
2	S400-403-066-LY1-02	Table Leg	4	2/2
3	S400-403-066-LY1-03	Metal Leg Support	1	2/2

HARDWARE LIST

REF		HARDWARE NAME	QTY
A		Bolt M8 x 16mm	8 PCS
B		Allen Key	1 PC
C		Adjusting Foot	4 PCS

PLEASE CHECK THAT YOU HAVE ALL THE PARTS LISTED BEFORE YOU START ASSEMBLING. IF YOU DO FIND THAT SOMETHING IS MISSING, DO NOT CONTINUE ASSEMBLY. PLEASE CONTACT YOUR SUPPLIER IMMEDIATELY.

STEP 1

PARTS REQUIRED

1 - TABLE TOP x1

2 - TABLE LEG x1

HARDWARE REQUIRED

A  01

TOOLS REQUIRED

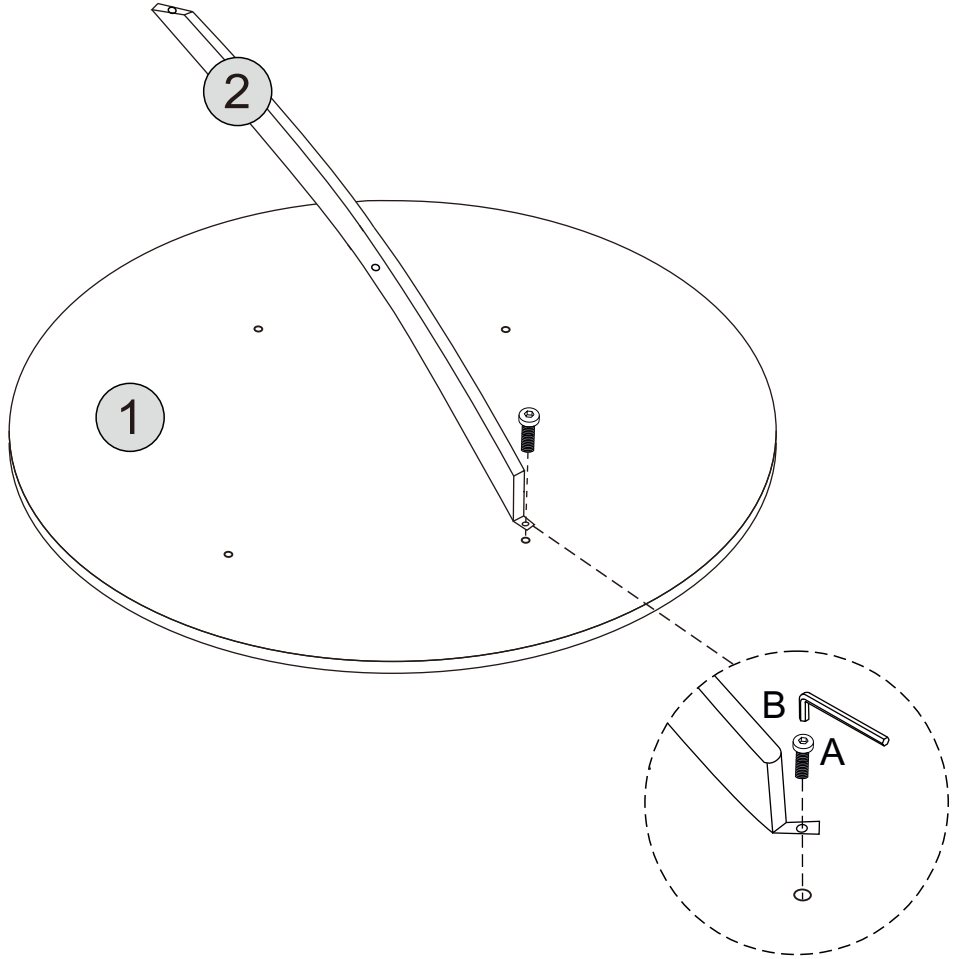

STEP 2

PARTS REQUIRED

2 - TABLE LEG x1

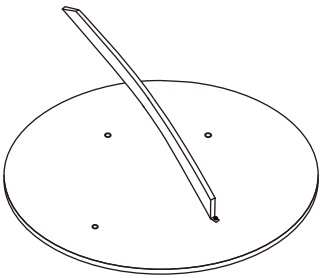

HARDWARE REQUIRED

A  01

TOOLS REQUIRED

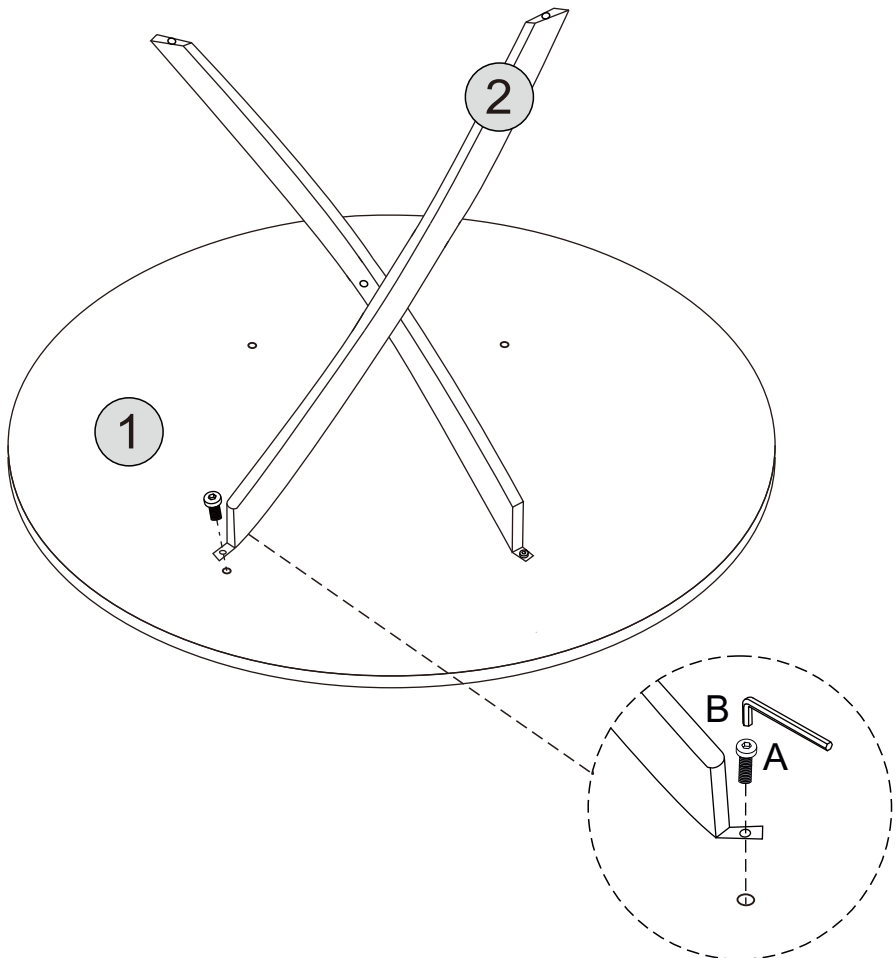

STEP 3

PARTS REQUIRED

2 - TABLE LEG x1

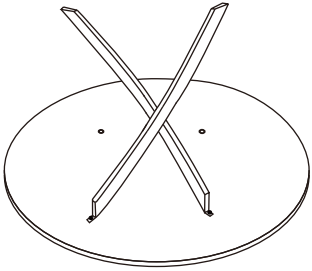

HARDWARE REQUIRED

A  01

TOOLS REQUIRED

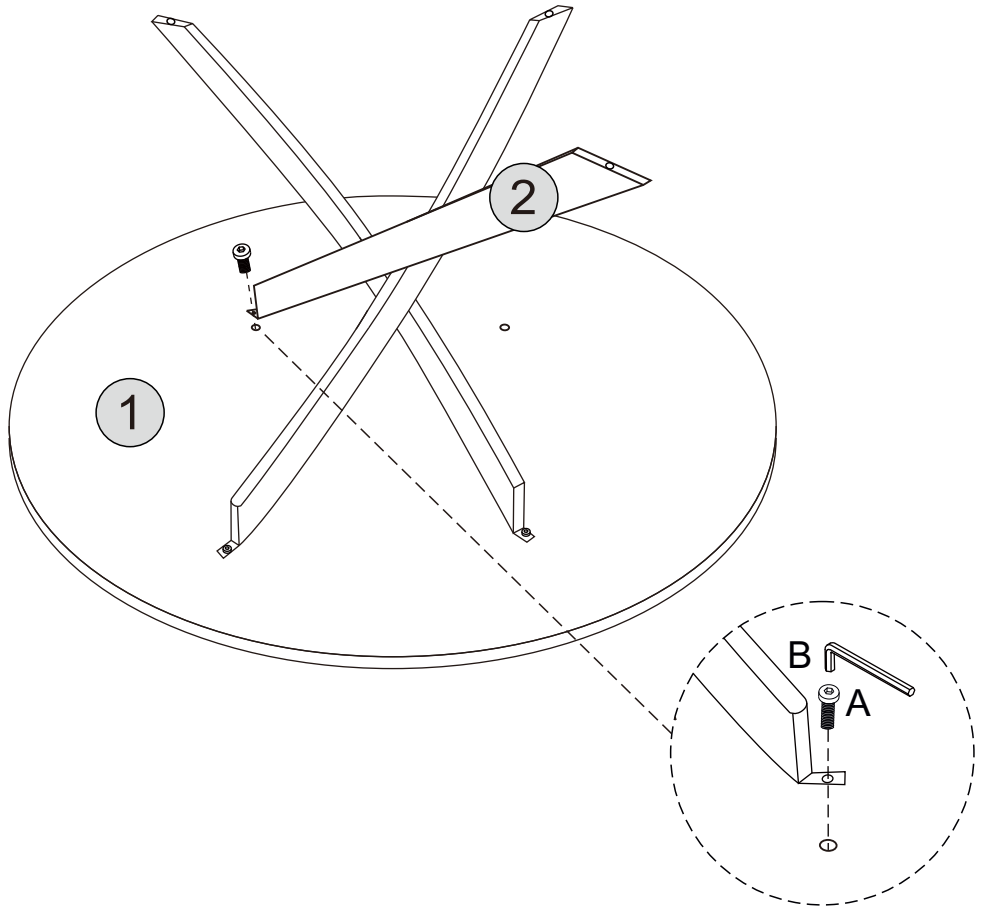

STEP 4

PARTS REQUIRED

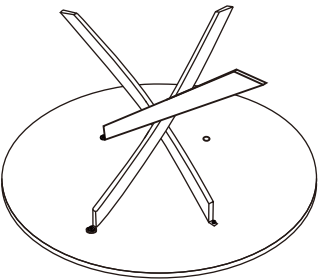

HARDWARE REQUIRED

A  01

TOOLS REQUIRED

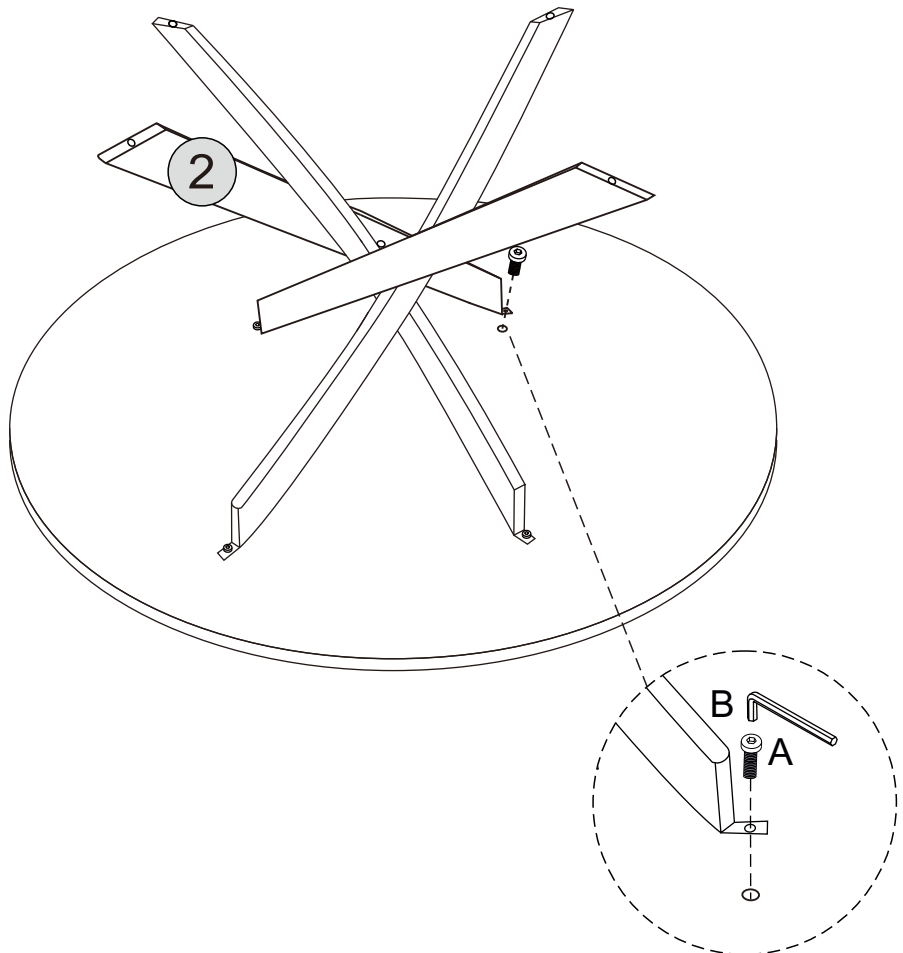

STEP 5

PARTS REQUIRED

3 - METAL LEG SUPPORT x1

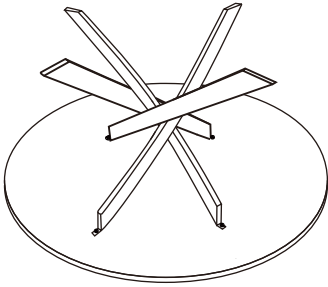

HARDWARE REQUIRED

A  04

TOOLS REQUIRED

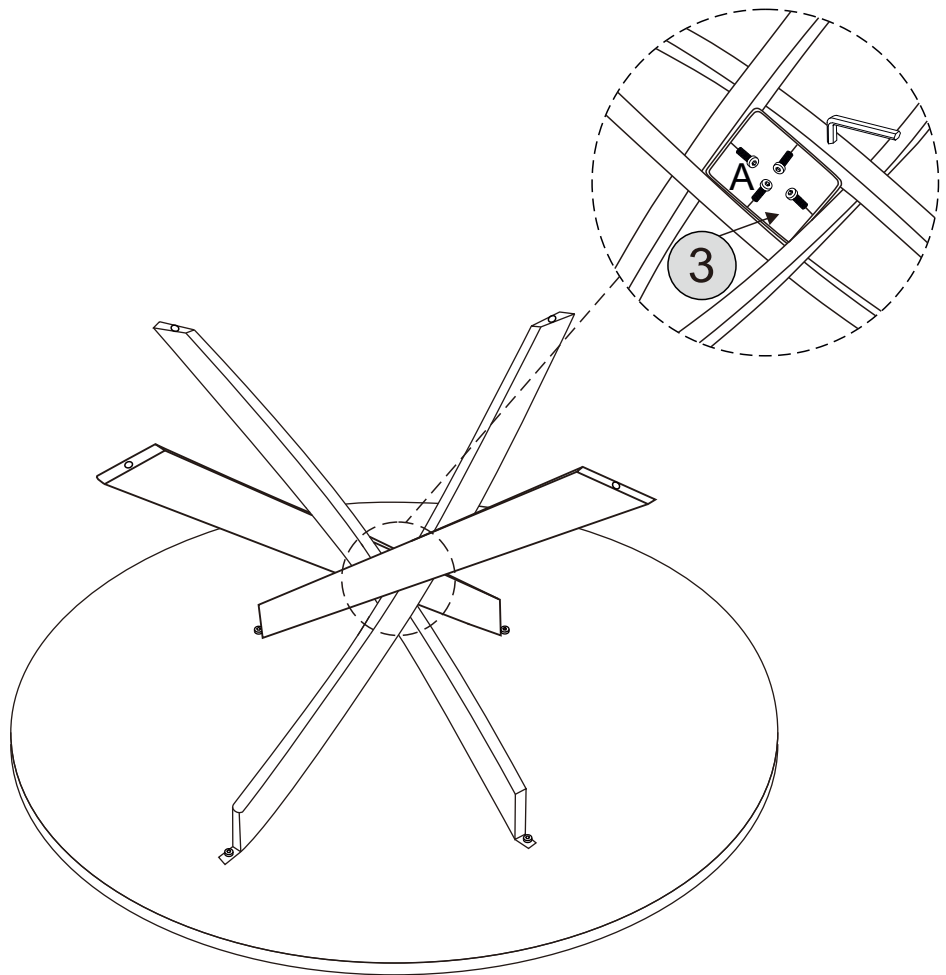
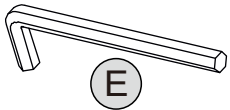

STEP 6

PARTS REQUIRED

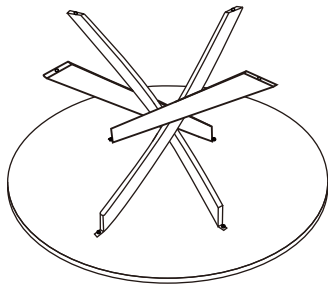

HARDWARE REQUIRED

C  04

TOOLS REQUIRED

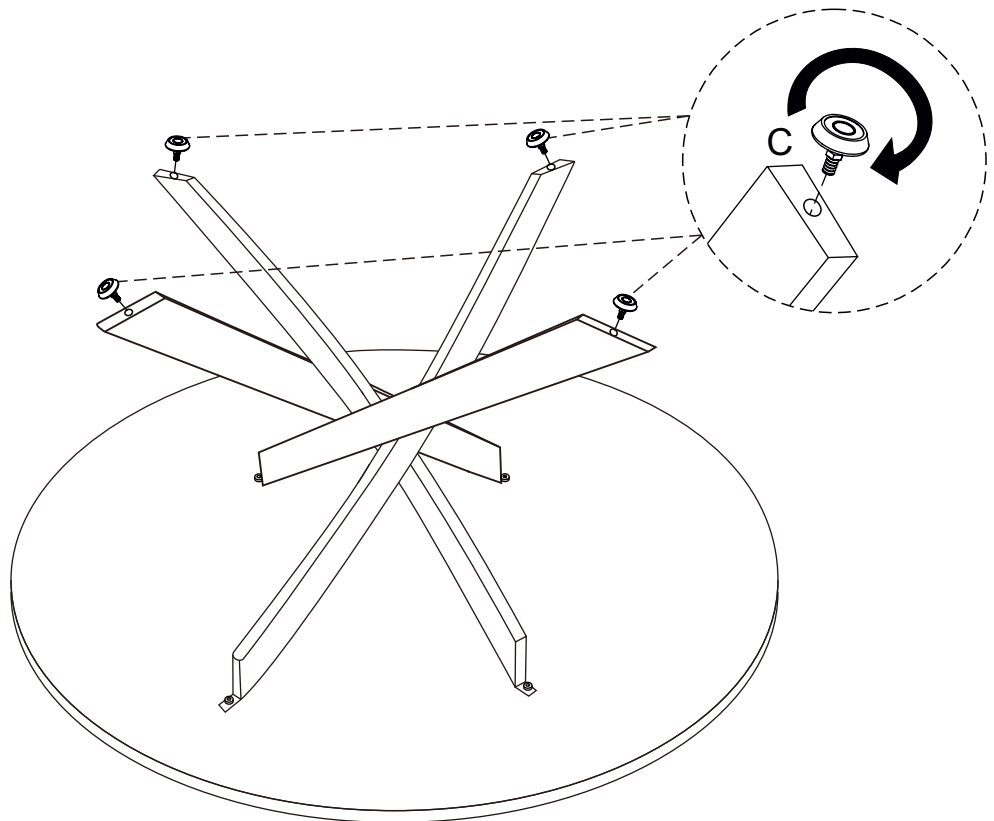

BROWN PU ATHENS DINING CHAIR ASSEMBLY INSTRUCTIONS



**MAX CHAIR
WEIGHT**

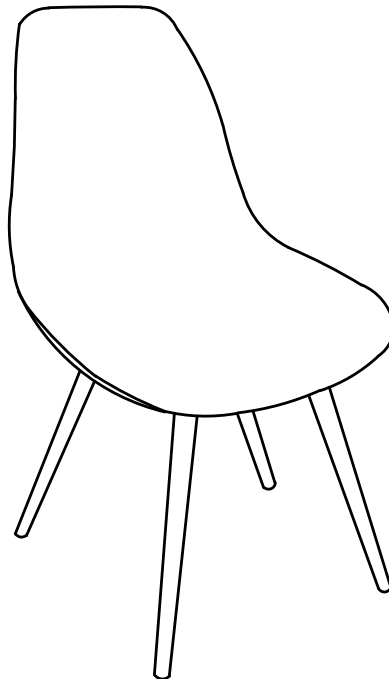

**IMPORTANT
FOR DOMESTIC USE ONLY
PLEASE READ BEFORE YOU CONTINUE FURTHER**

THE PRODUCT YOU HAVE PURCHASED WILL GIVE YOU MANY YEARS OF SERVICE IF YOU FOLLOW THE GUIDELINES FOR ITS SAFE ASSEMBLY AND PERIODIC MAINTENANCE AND CLEANING .

ASSEMBLE ON A SOFT CLEAN SURFACE

DO NOT USE ANY TOOLS OTHER THAN THOSE SHOWN.

ANY SPANNERS OR ALLEN KEYS REQUIRED ARE INCLUDED WITH THE FITTINGS KIT.

DO NOT FOR ANY REASON USE A POWER TOOL TO ASSEMBLE THIS PRODUCT. ITS USE WILL INVALIDATE ANY CLAIM YOU MAY HAVE AND COULD MAKE THIS PRODUCT UNSAFE.

DEPENDING ON THE AMOUNT OF USE THIS PRODUCT RECEIVES IT MAY BE NECESSARY TO TIGHTEN UP THE FIXINGS FROM TIME TO TIME . THIS IS COMPLETELY NORMAL FOR ANY FLAT PACK FURNITURE.

DO NOT OVERTIGHTEN FIXINGS.

FOR CLEANING, YOU MAY USE A DAMP CLOTH (NOT WET) DO NOT USE POLISH, DETERGENT OR CHEMICAL CLEANERS.

THIS PRODUCT MAY STAIN OR MARK IF ALLOWED TO COME INTO CONTACT WITH WET OR DAMP OBJECTS.

THE SURFACE OF THIS ITEM IS NOT HEAT RESISTANT. ALWAYS USE A PLACE MAT UNDER HOT OR COLD ITEMS TO PREVENT MARKING.

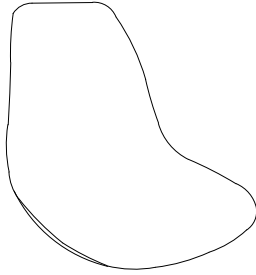

1

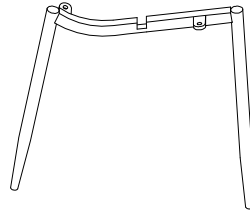

2

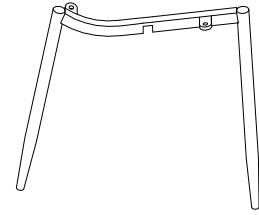

3

PARTS LIST

Part Number	Part Code	Part Description	Quantity	Carton
1	S400-402-125-SF1-01	Seat Pad	1	1/1
2	S400-402-125-SF1-02	Chair Leg (A)	1	1/1
3	S400-402-125-SF1-03	Chair Leg (B)	1	1/1

HARDWARE LIST

REF		HARDWARE NAME	QTY
A		Bolts M8x25mm	4PCS
B		Bolts M8x40mm	1PC
C		Allen Key	1PC
D		Metal Washer	5PCS



PLEASE CHECK THAT YOU HAVE ALL THE PARTS LISTED BEFORE YOU START ASSEMBLING. IF YOU DO FIND THAT SOMETHING IS MISSING, DO NOT CONTINUE ASSEMBLY. PLEASE CONTACT YOUR SUPPLIER IMMEDIATELY.

STEP 1

PARTS REQUIRED

1 - SEAT PAD	x1
2 - CHAIR LEG (A)	x1
3 - CHAIR LEG (B)	x1

HARDWARE REQUIRED

B		01
D		01

TOOLS REQUIRED

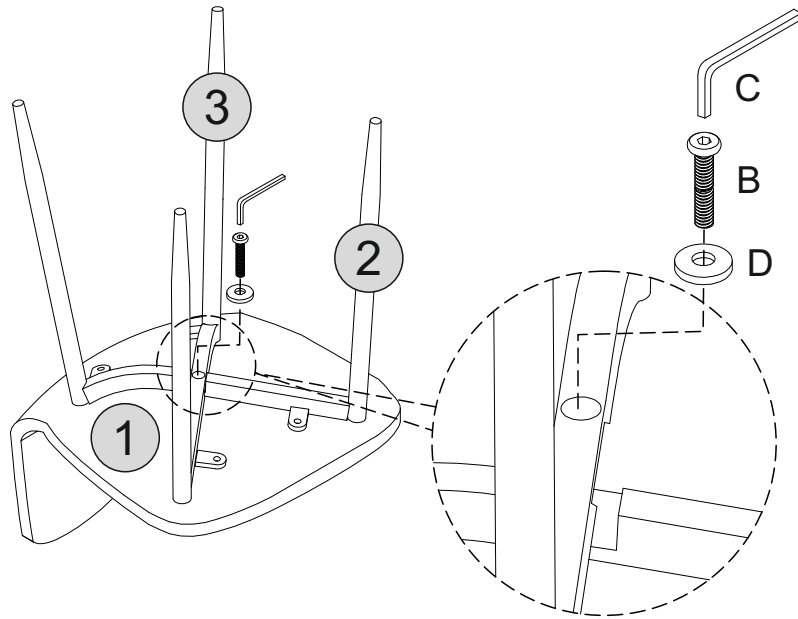
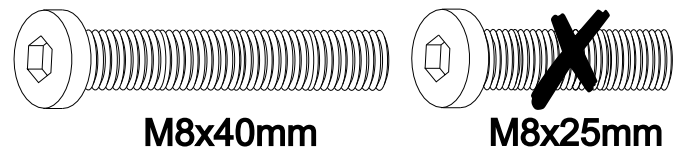

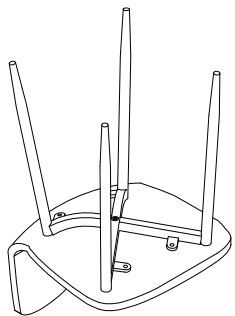

STEP 2

PARTS REQUIRED



HARDWARE REQUIRED

A		04
D		04

TOOLS REQUIRED

