

BARLEY DINING CHAIR ASSEMBLY INSTRUCTIONS

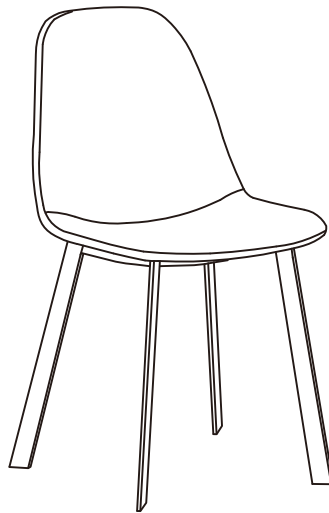

**MAX CHAIR
WEIGHT**



**IMPORTANT
FOR DOMESTIC USE ONLY**

PLEASE READ BEFORE YOU CONTINUE FURTHER

THE PRODUCT YOU HAVE PURCHASED WILL GIVE YOU MANY YEARS OF SERVICE IF YOU FOLLOW THE GUIDELINES FOR ITS SAFE ASSEMBLY AND PERIODIC MAINTENANCE AND CLEANING .

ASSEMBLE ON A SOFT CLEAN SURFACE

DO NOT USE ANY TOOLS OTHER THAN THOSE SHOWN.

ANY SPANNERS OR ALLEN KEYS REQUIRED ARE INCLUDED WITH THE FITTINGS KIT.

DO NOT FOR ANY REASON USE A POWER TOOL TO ASSEMBLE THIS PRODUCT. ITS USE WILL INVALIDATE ANY CLAIM YOU MAY HAVE AND COULD MAKE THIS PRODUCT UNSAFE.

DEPENDING ON THE AMOUNT OF USE THIS PRODUCT RECEIVES IT MAY BE NECESSARY TO TIGHTEN UP THE FIXINGS FROM TIME TO TIME . THIS IS COMPLETELY NORMAL FOR ANY FLAT PACK FURNITURE.
DO NOT OVERTIGHTEN FIXINGS.

FOR CLEANING, YOU MAY USE A DAMP CLOTH (NOT WET) DO NOT USE POLISH, DETERGENT OR CHEMICAL CLEANERS.

THIS PRODUCT MAY STAIN OR MARK IF ALLOWED TO COME INTO CONTACT WITH WET OR DAMP OBJECTS.

THE SURFACE OF THIS ITEM IS NOT HEAT RESISTANT. ALWAYS USE A PLACE MAT UNDER HOT OR COLD ITEMS TO PREVENT MARKING.

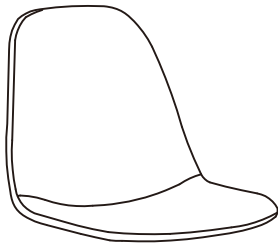

1

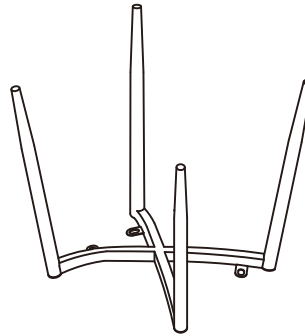



2

PARTS LIST

Part Number	Part Code	Part Description	Quantity	Carton
1	S400-402-108-SF1-01	Chair Seat	1	1/1
2	S400-403-108-SF1-02	Chair Leg	1	1/1

HARDWARE LIST

REF	PART NAME		QTY
A		Bolts M6x16mm	4 PCS
B	 M6x16	Metal Washer	4 PCS
C	 M5	Allan Key	1 PC

PLEASE CHECK THAT YOU HAVE ALL THE PARTS LISTED BEFORE YOU START ASSEMBLING. IF YOU DO FIND THAT SOMETHING IS MISSING, DO NOT CONTINUE ASSEMBLY. PLEASE CONTACT YOUR SUPPLIER IMMEDIATELY.

STEP 1

PARTS REQUIRED

1 - CHAIR SEAT x1

2 - CHAIR LEG x1

HARDWARE REQUIRED

A  04

B  04

TOOLS REQUIRED

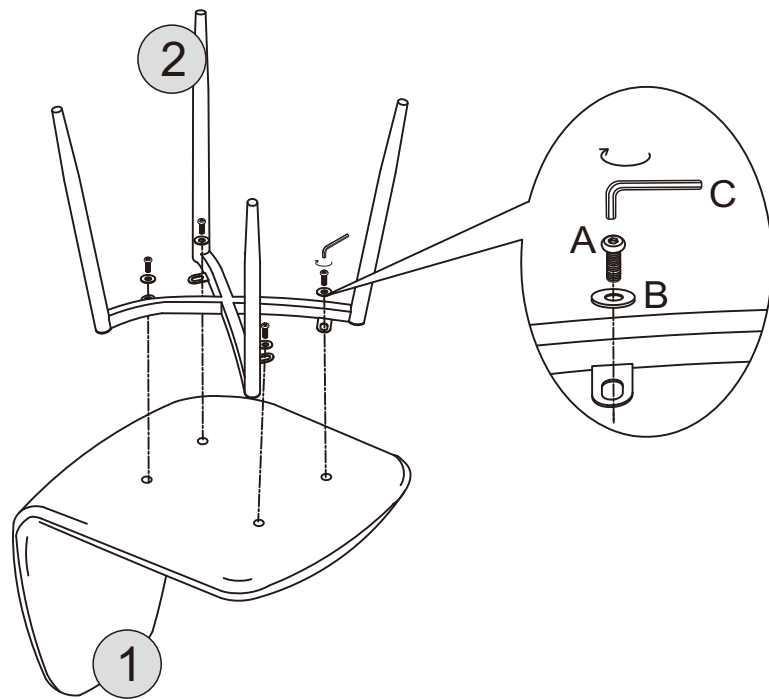

STEP 2

PARTS REQUIRED

HARDWARE REQUIRED

TOOLS REQUIRED

