

# Corona 2 Door 5 Drawer Sideboard

## ASSEMBLY INSTRUCTIONS

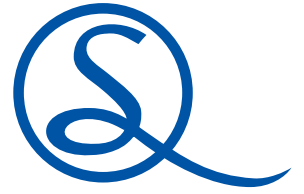
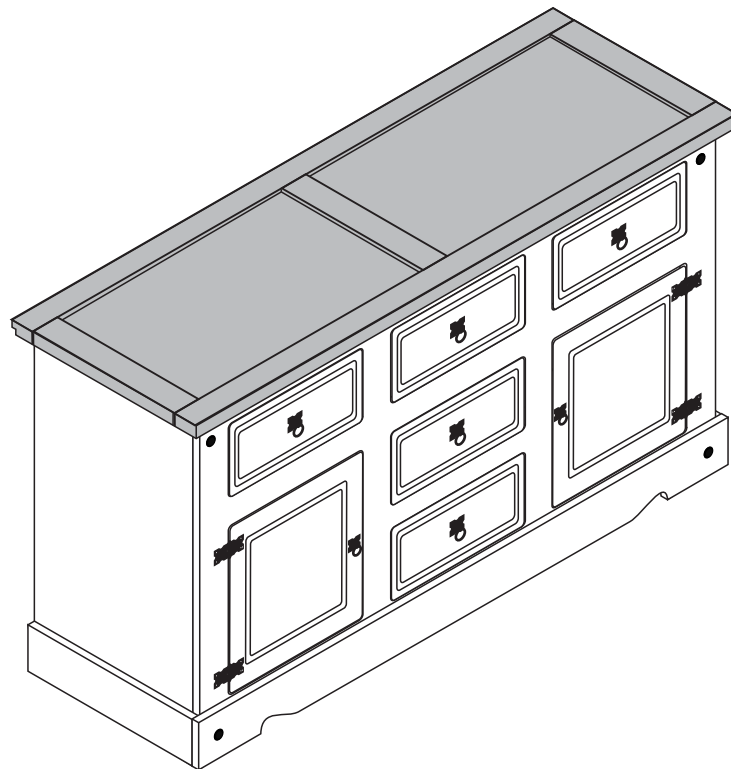

### FOR DOMESTIC USE ONLY

### IMPORTANT

PLEASE READ BEFORE YOU CONTINUE FURTHER

## CARE AND MAINTENANCE

After unpacking this product please keep the original packaging in case it needs to be returned for any reason.

- Please ensure all fittings and parts are present before commencing with assembly.
- We recommend that you lay a blanket or sheet on the floor to avoid damage to both your floor and the product.
- We strongly recommend that you keep children away from your work area.
- Assemble this product as close to its final position as possible.
- Never drag or push products as this could cause damage to the joints making it inferior.
- Do not place this product next to a radiator or in direct sunlight.
- Wood is a natural product and may expand if subjected to damp and may shrink or crack if subjected to heat. Therefore it is recommended that room temperature is maintained, with no sudden temperature fluctuations.
- Make sure any spillage is wiped off immediately.
- Do not place hot or chilled items directly on to the surface, use a place mat or marking will occur.
- For general cleaning use a duster, and do not use detergents of any kind. However, the surface will need to be retreated from time to time. This can be done by using block wax (unperfumed) and rubbing it over the whole item.
- From time to time it may be necessary to tighten fittings, regular inspections should be carried out.

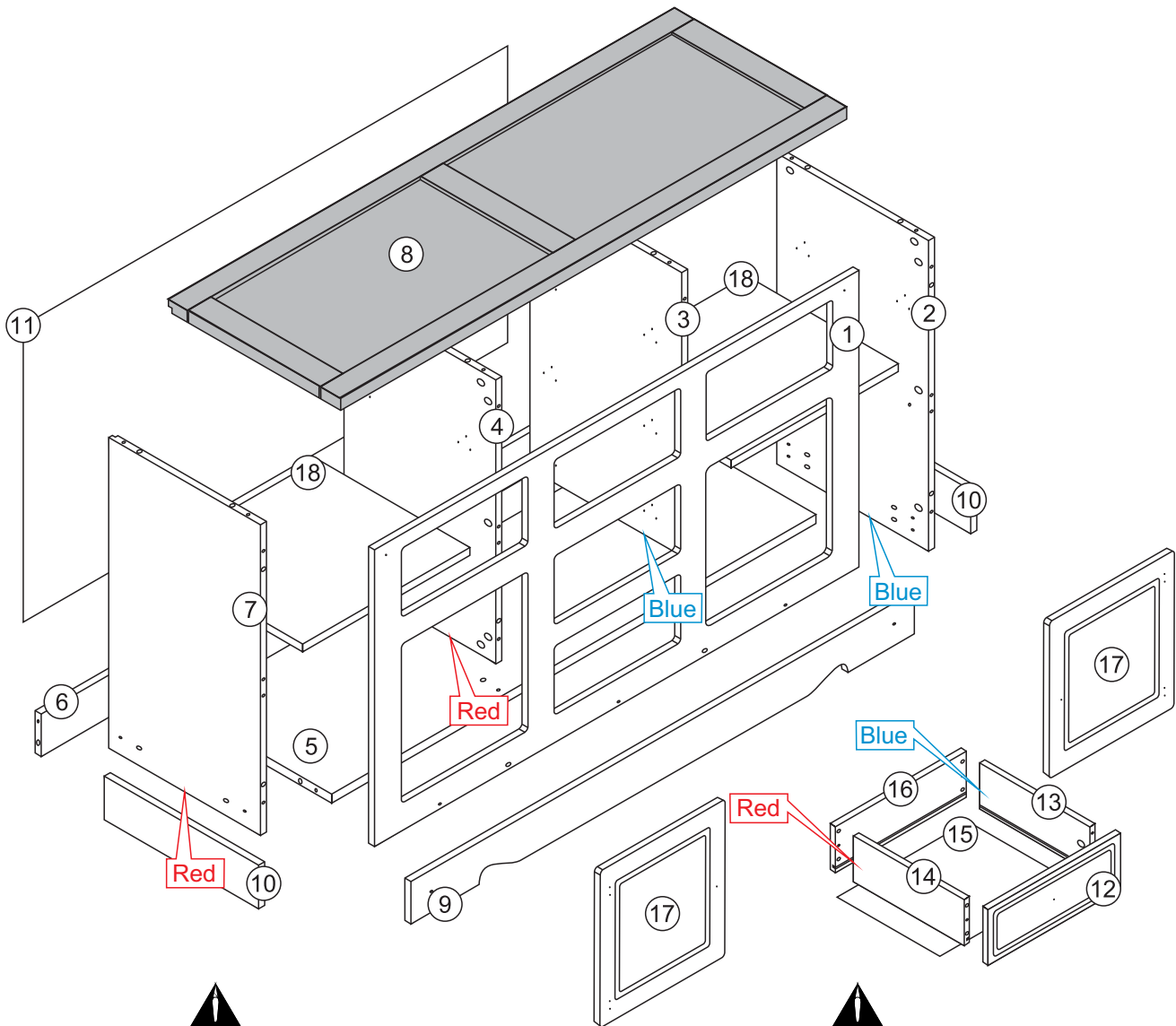

!   
 \* Use of power tools to assemble this product will invalidate any claim and damage this product making it unsafe !!!  
 \* Please assemble on a clean soft surface to avoid damage.



















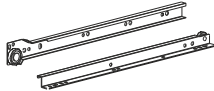





!   
 \* Please check contents and read the instructions before commencing assembly.  
 \* Assemble this product following the enclosed instructions carefully.  
 \* Please take care to avoid damaging panels during assembly.

### PARTS LIST

1	Front Frame	x1
2	Right Side Panel (Blue)	x1
3	Right Center Panel (Blue)	x1
4	Left Center Panel (Red)	x1
5	Base	x1
6	Back Crossbeam	x1
7	Left Side (Red)	x1
8	Top Panel	x1
9	Front Plinth	x1

10	Side Plinth	x2
11	Back Panel	x1
12	Drawer Front	x5
13	Right Drawer Side (Blue)	x5
14	Left Drawer Side (Red)	x5
15	Drawer Base	x5
16	Drawer Back	x5
17	Right/Left Door	x2
18	Ajustable Shelf	2x

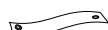
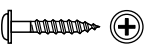
# Fittings List

<p><b>A</b></p>  <p>Cam Bolt (26x)</p>	<p><b>B</b></p>  <p>Cam Nut (34x)</p>	<p><b>C</b></p>  <p>Hole Plugs White (20x)</p>
<p><b>D</b></p>  <p>Dowel Ø8x30 (74x)</p>	<p><b>E</b></p>  <p>Plastic Foot (7x)</p>	<p><b>F</b></p>  <p>Drawer Spacer (8x)</p>
<p><b>G</b></p>  <p>Blanking Plug Screw Ø6x12 (8x)</p>	<p><b>H</b></p>  <p>Black Handle With Bolt (7x)</p>	<p><b>I</b></p>  <p>Drawer Runner 350mm (5xSet)</p>
<p><b>J</b></p>  <p>Allen Key 3mm (1x)</p>	<p><b>K</b></p>  <p>Superb Bolt (16x) 5 x 50mm</p>	<p><b>L</b></p>  <p>Flanged Screw Ø3,5 x 25mm (7x)</p>
<p><b>M</b></p>  <p>Flat Head Screw Ø3 x 14mm (52x)</p>	<p><b>N</b></p>  <p>Nail 10 x 10mm (60x)</p>	<p><b>O</b></p>  <p>Glue (2x)</p>
<p><b>P</b></p>  <p>Roller Catch (2x)</p>	<p><b>Q</b></p>  <p>Black Stud (4x)</p>	<p><b>R</b></p>  <p>Shelf Support (8x)</p>
<p><b>S</b></p>  <p>Black Head Screw 3,5 x 14 (24x)</p>	<p><b>T</b></p>  <p>Black Hinge (4x)</p>	<p><b>U</b></p>  <p>Cam Bolt To Fix The Top (8x)</p>
<p><b>V</b></p>  <p>Blanking Plug Flat Head Screw Ø6x10 (12x)</p>	<p><b>X</b></p>  <p>Dowel Ø8x40 (4x)</p>	<p><b>W</b></p>  <p>Strap (Anti-Tip Kit) (1x)</p>
<p><b>Y</b></p>  <p>Wood Screw (Anti-Tip Kit) 3,5 x 30 mm (1x)</p>	<p><b>Z</b></p>  <p>Washer (Anti-Tip Kit) (2x)</p>	<p><b>AA</b></p>  <p>Flanged Screw Ø5 x 50 mm (10x)</p>





# Pre-Assembly

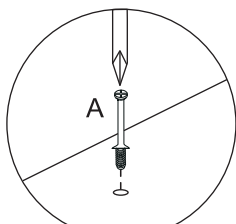
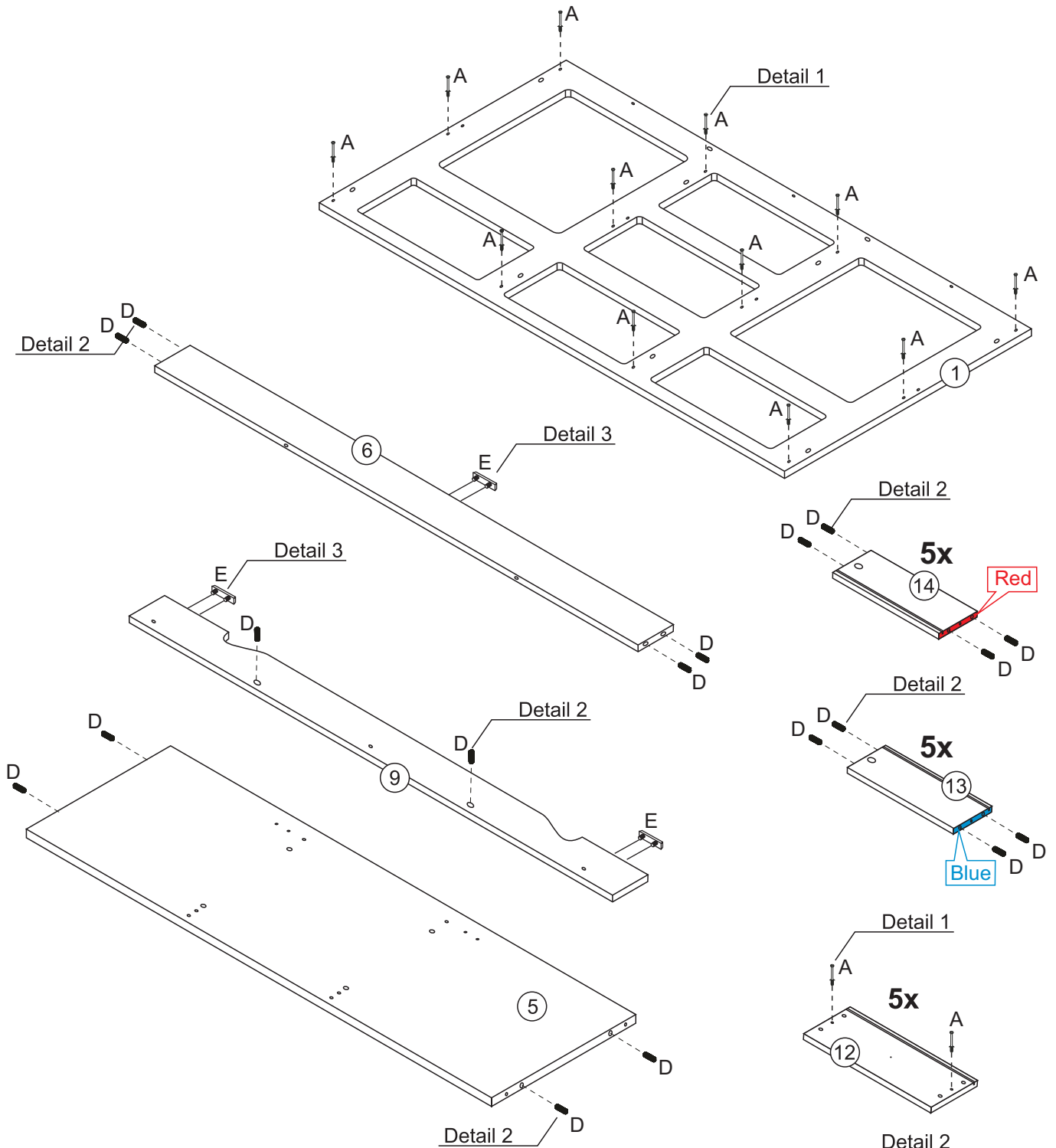
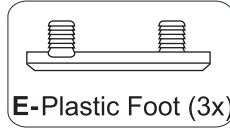
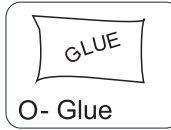
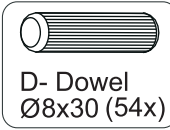
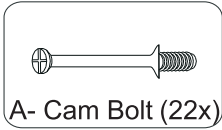

Detail 1



Detail 2

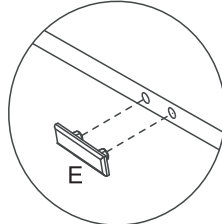

Detail 3

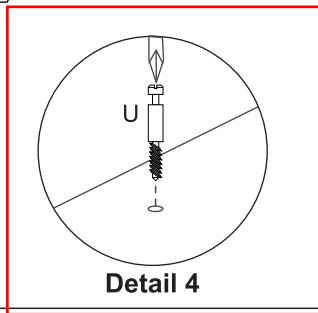



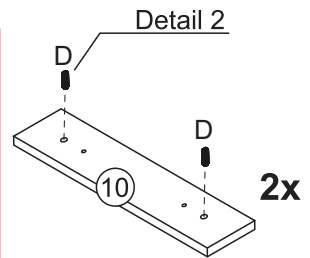



Detail 4

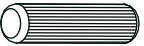

Detail 2

2x

# Pre-Assembly

 D- Dowel Ø8x30 (10x)	 O- Glue	 F-Drawer Spacer (4x)	 G-Blanking Plug Screw Ø6x12 (4x)	 I-Drawer Runner 350mm (8x)	 M-Flat Head Screw Ø3 x 14mm (12x)
					 V- Blanking Plug Flat Head Screw Ø6x10 (12x)

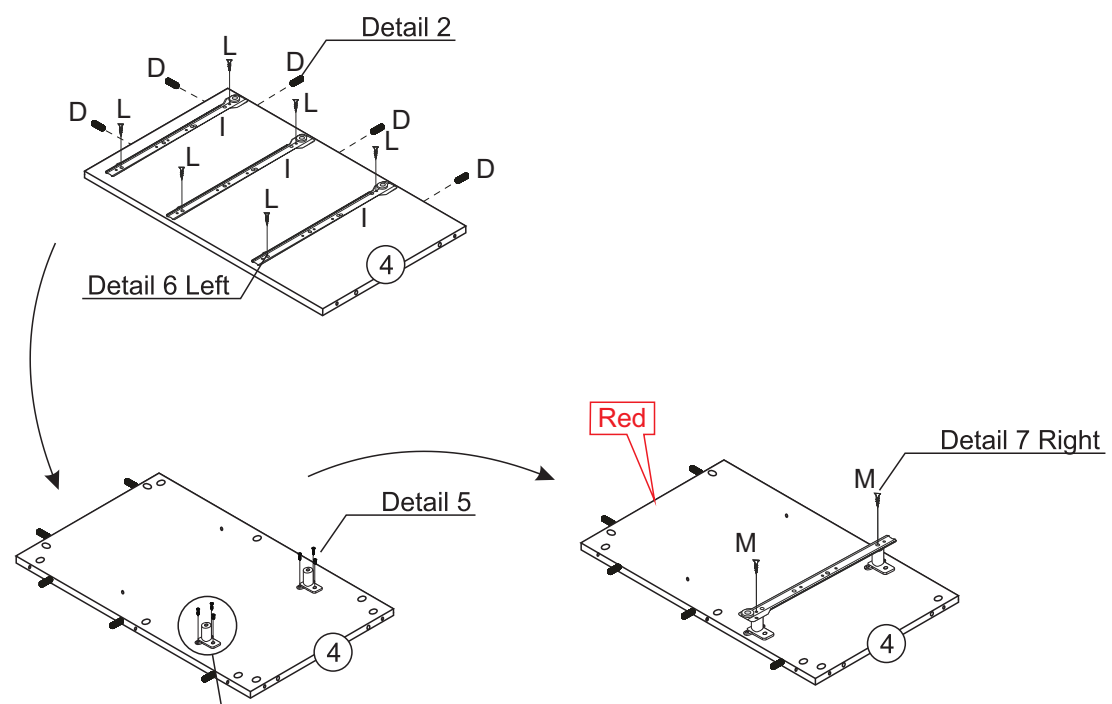
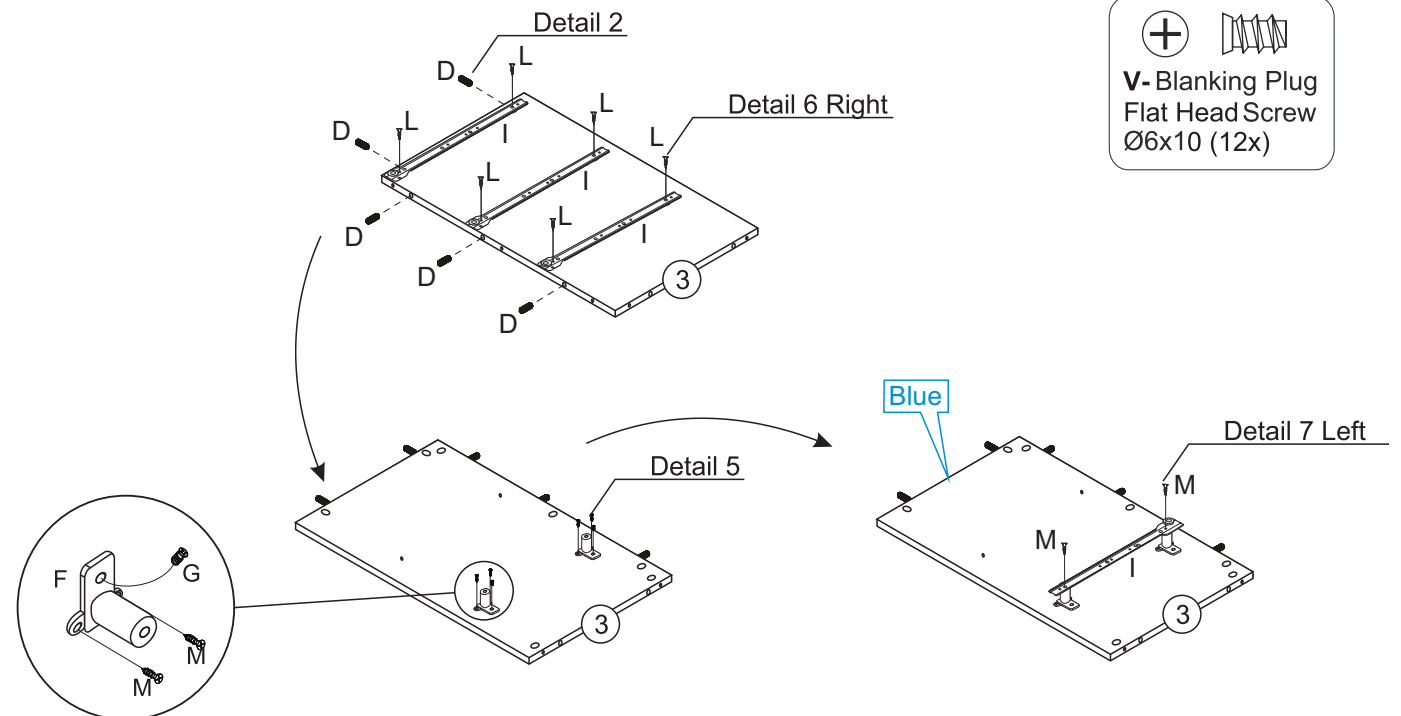

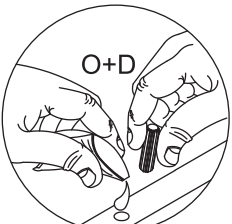
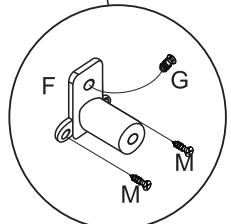
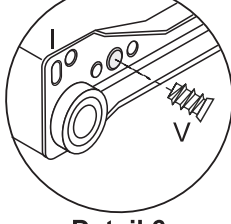
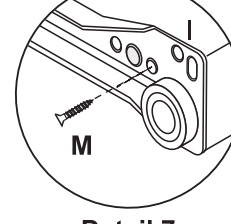
 O+D	 F G M	 I V	 M
<b>Detail 2</b>	<b>Detail 5</b>	<b>Detail 6 Left/Right</b>	<b>Detail 7 Left/Right</b>

# Pre-Assembly

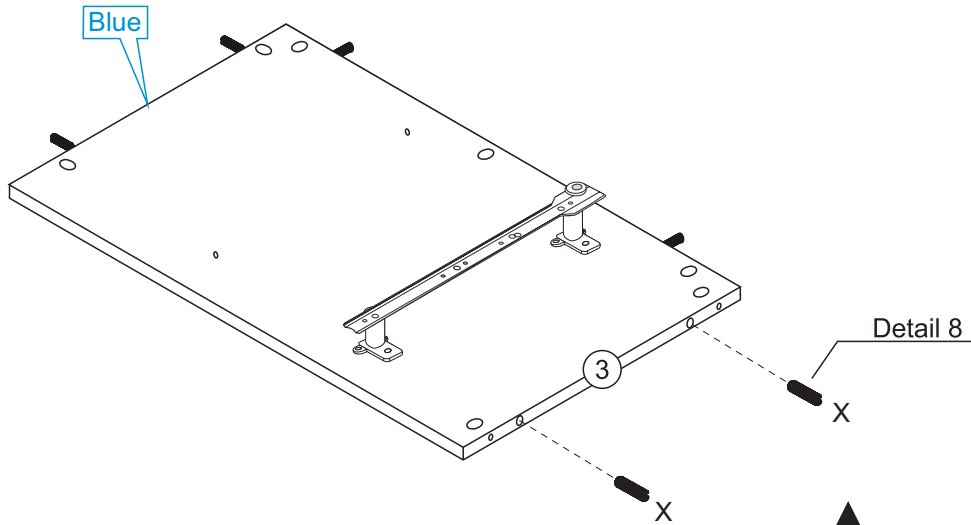
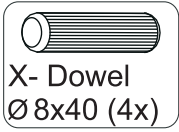

**!**  
Please, use the biggest dowel  
only in this part.

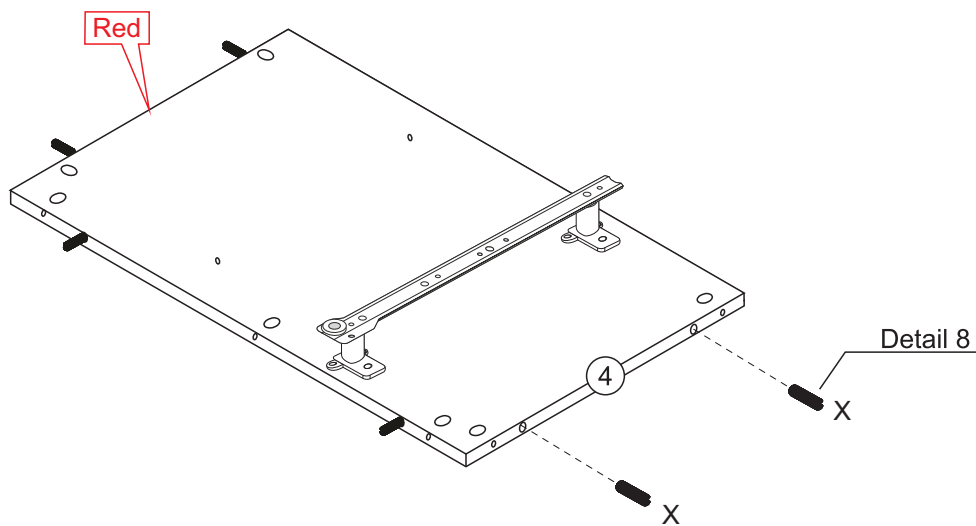

Detail 8

# Pre-Assembly



**M-Flat Head Screw**  
Ø3 x 14mm (12x)

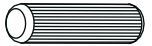

**D-Dowel**  
Ø8x30 (10x)



**O- Glue**

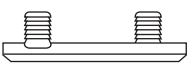

**E-Plastic Foot (4x)**



**F-Drawer Spacer (4x)**



**G-Blanking Plug Screw Ø6x12 (4x)**



**I-Drawer Runner 350mm (2x)**

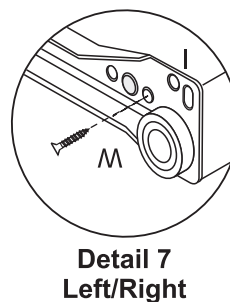
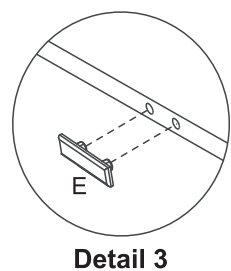
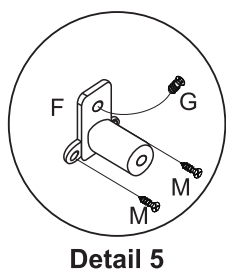
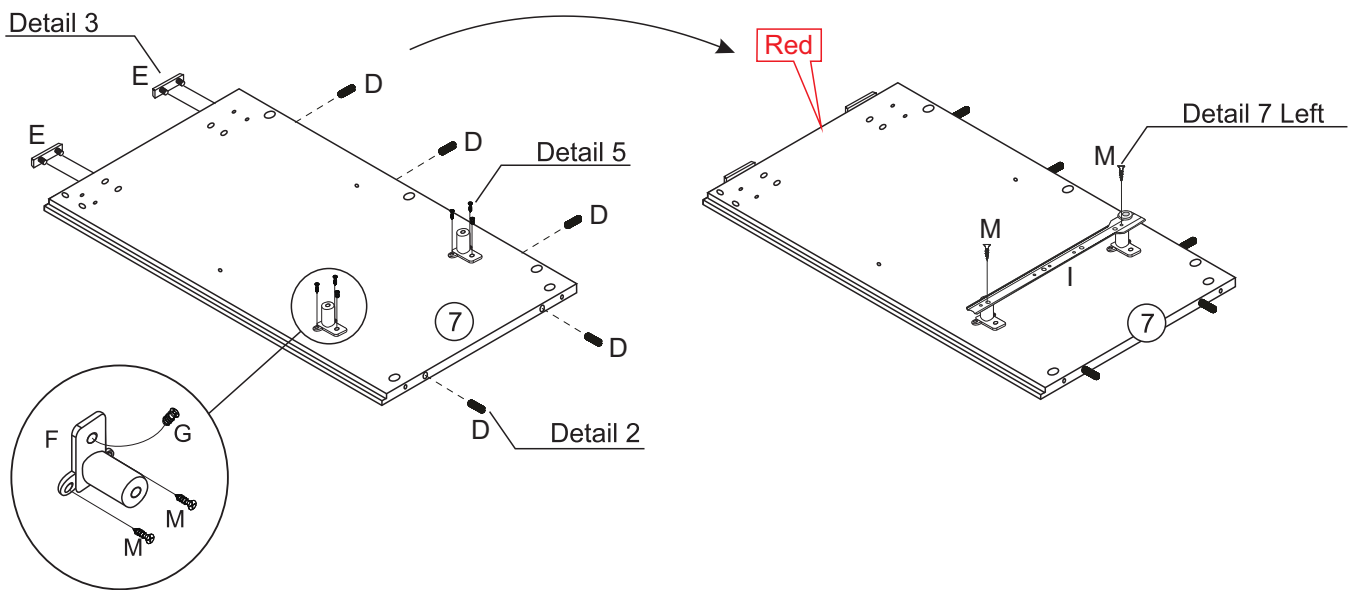
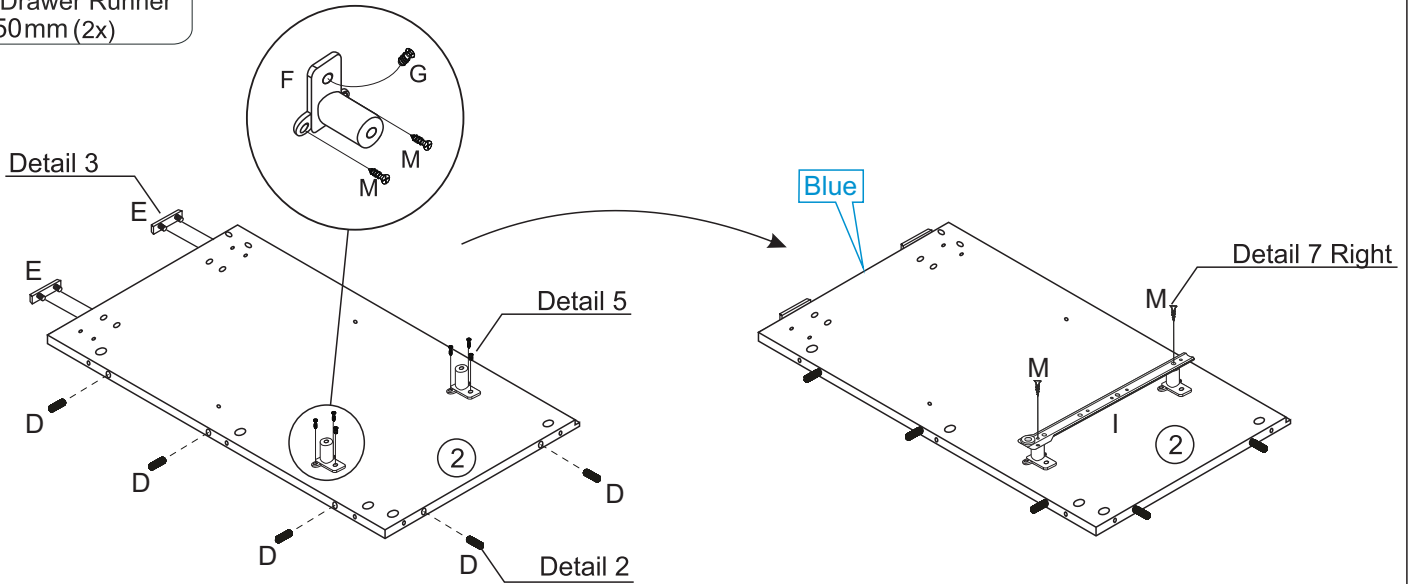



1

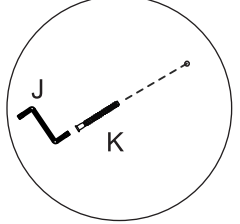
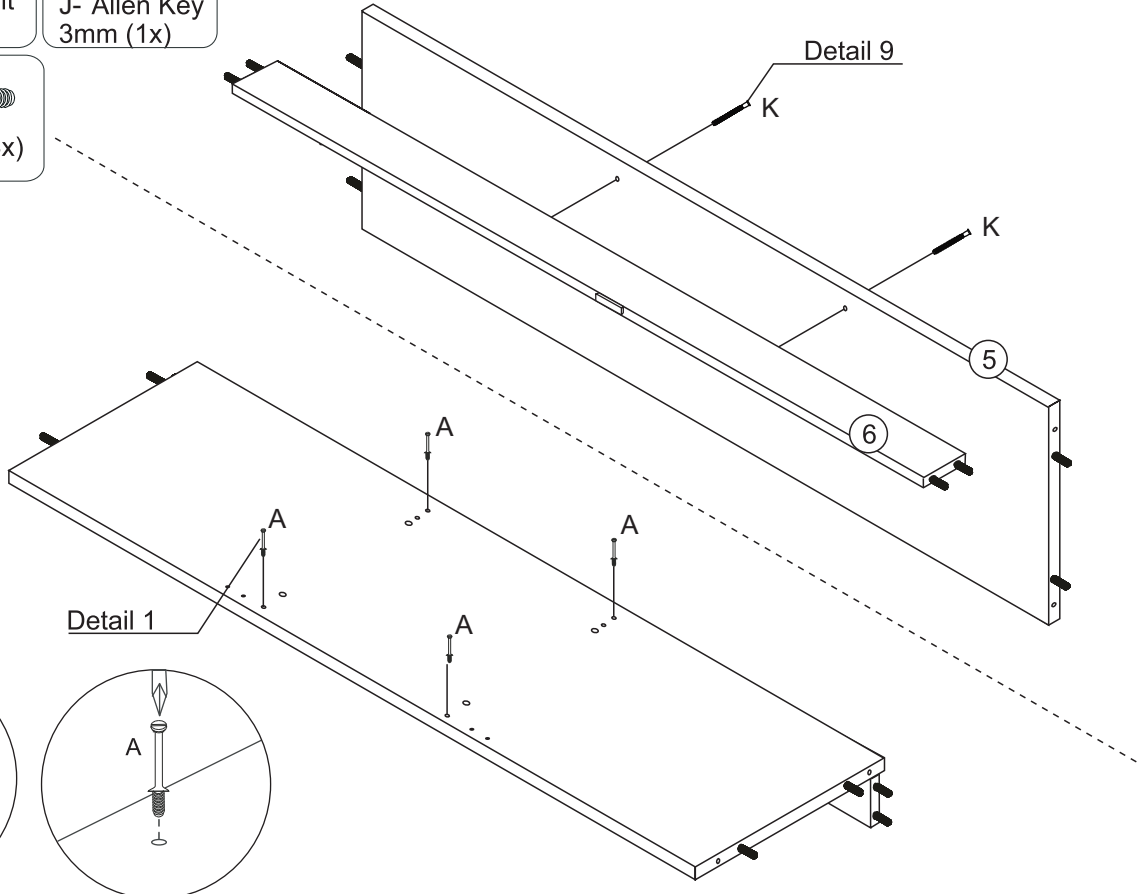
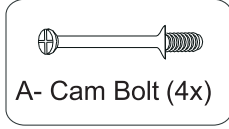
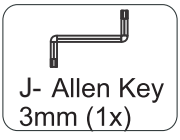
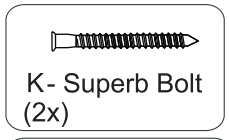

Detail 9

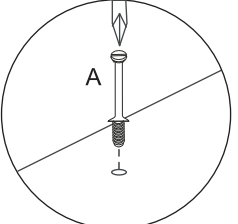

Detail 1

2

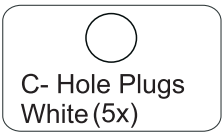
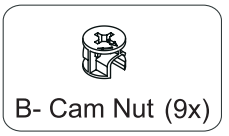



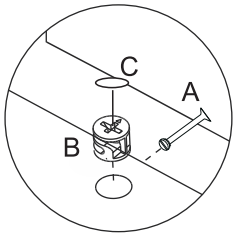
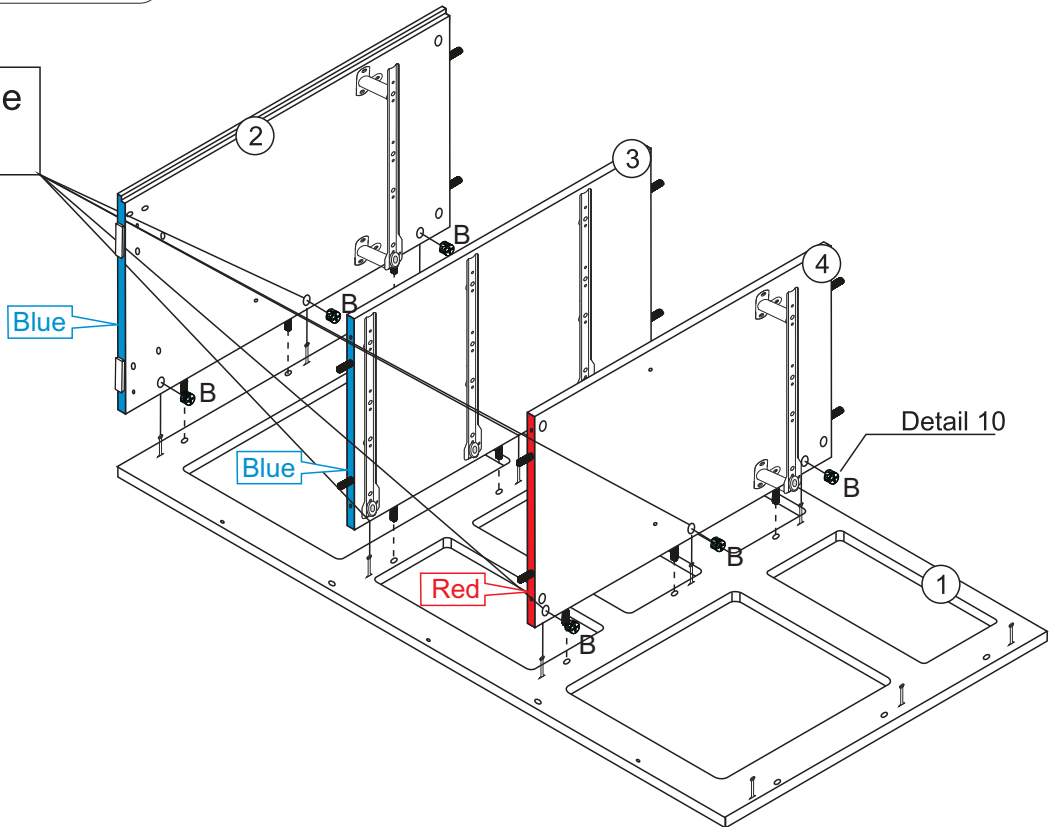

**Only Use The Hole Plugs Here.**



Detail 10

Fit and turn the cam clockwise

3

-   
 B- Cam Nut (4x)
-   
 K- Superb Bolt (2x)
-   
 J- Allen Key 3mm (1x)
-   
 C- Hole Plugs White (4x)

  
**Only Use The Hole Plugs Here.**

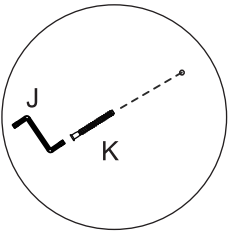
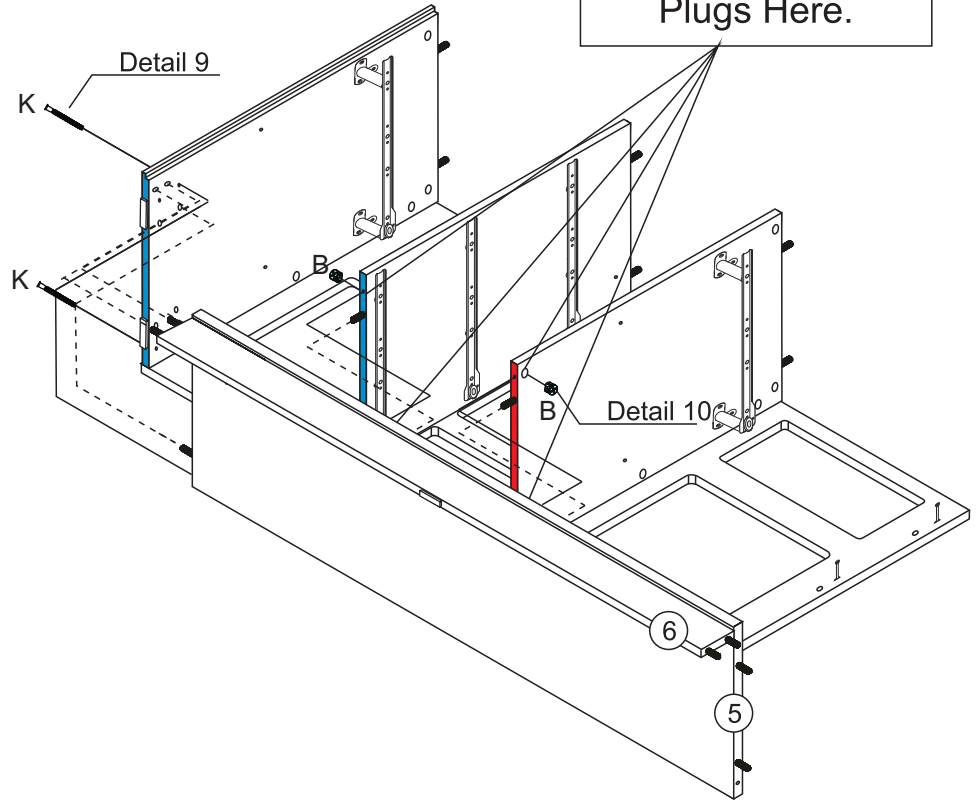



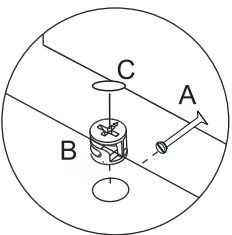

**Detail 9**



**Detail 10**

Fit and turn the cam clockwise

4

-   
 B- Cam Nut (3x)
-   
 C- Hole Plugs White (1x)
-   
 K- Superb Bolt (2x)
-   
 J- Allen Key 3mm (1x)

  
**Only Use The Hole Plugs Here.**

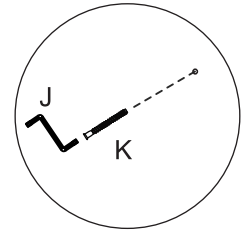
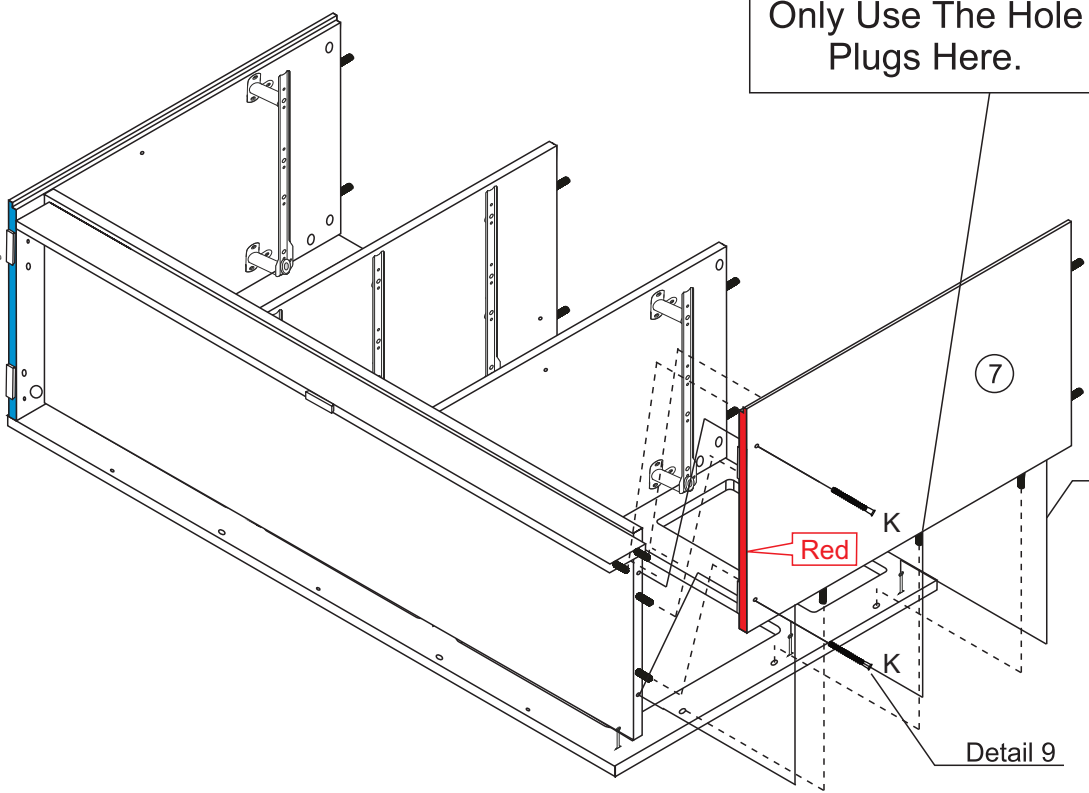

**Detail 9**

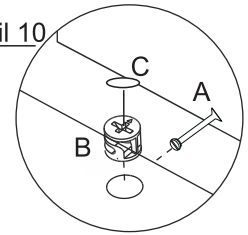

**Detail 10**

Fit and turn the cam clockwise

5



B- Cam Nut (8x)

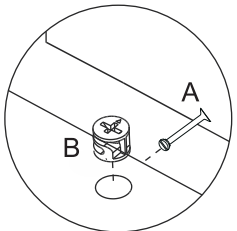
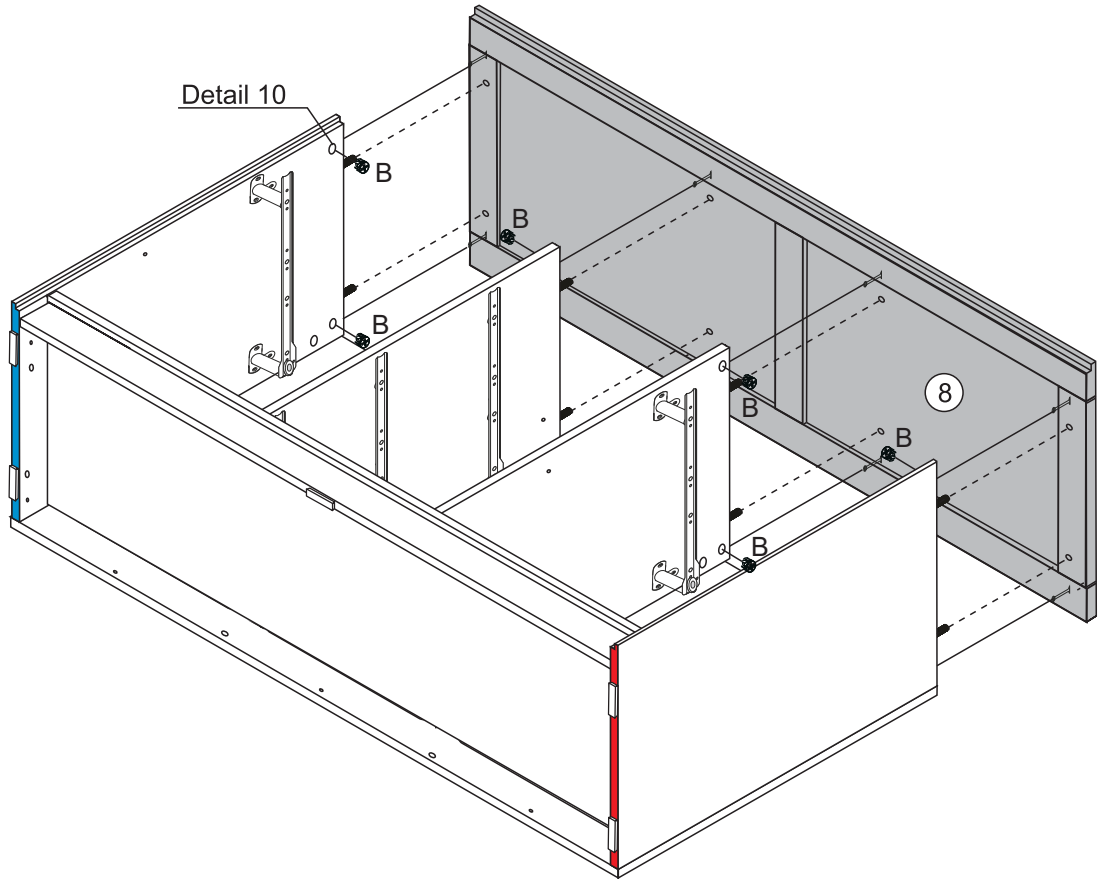

Detail 10

Fit and turn the cam clockwise

6



Flanged Screw  
Ø3,5 x 25mm (3x)

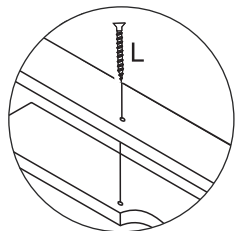
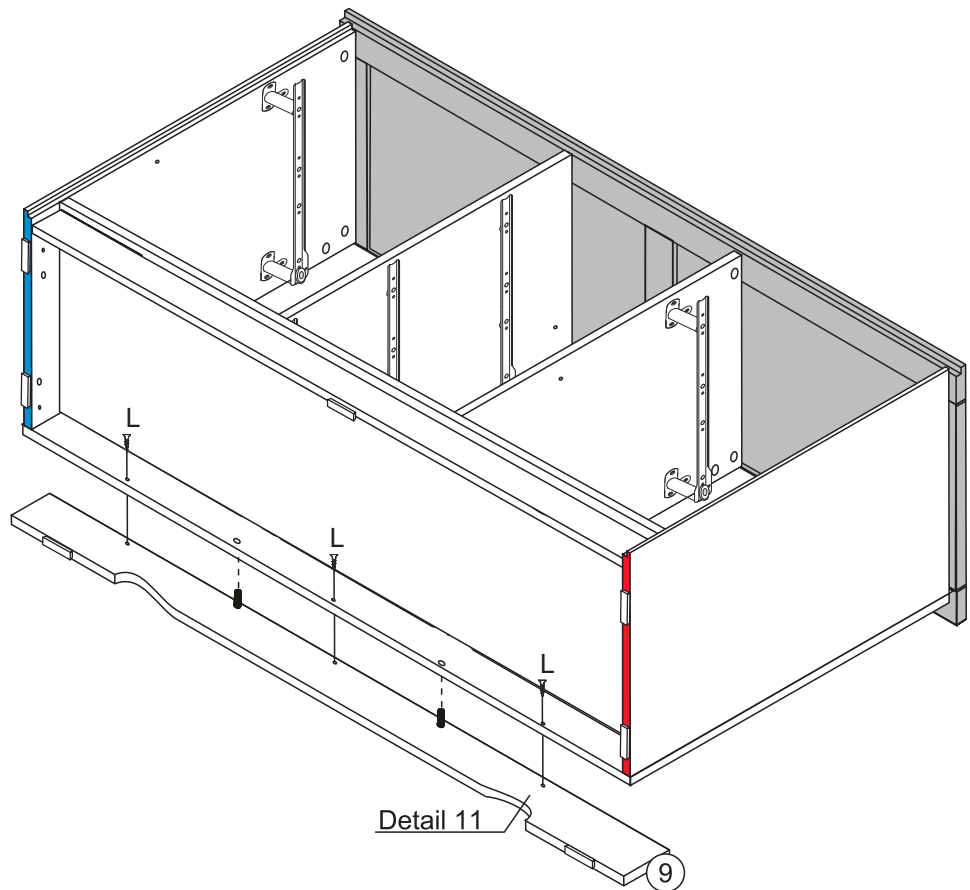

Detail 11

7



Flanged Screw  
Ø3,5 x 25mm (4x)

Detail 11

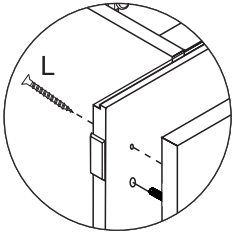
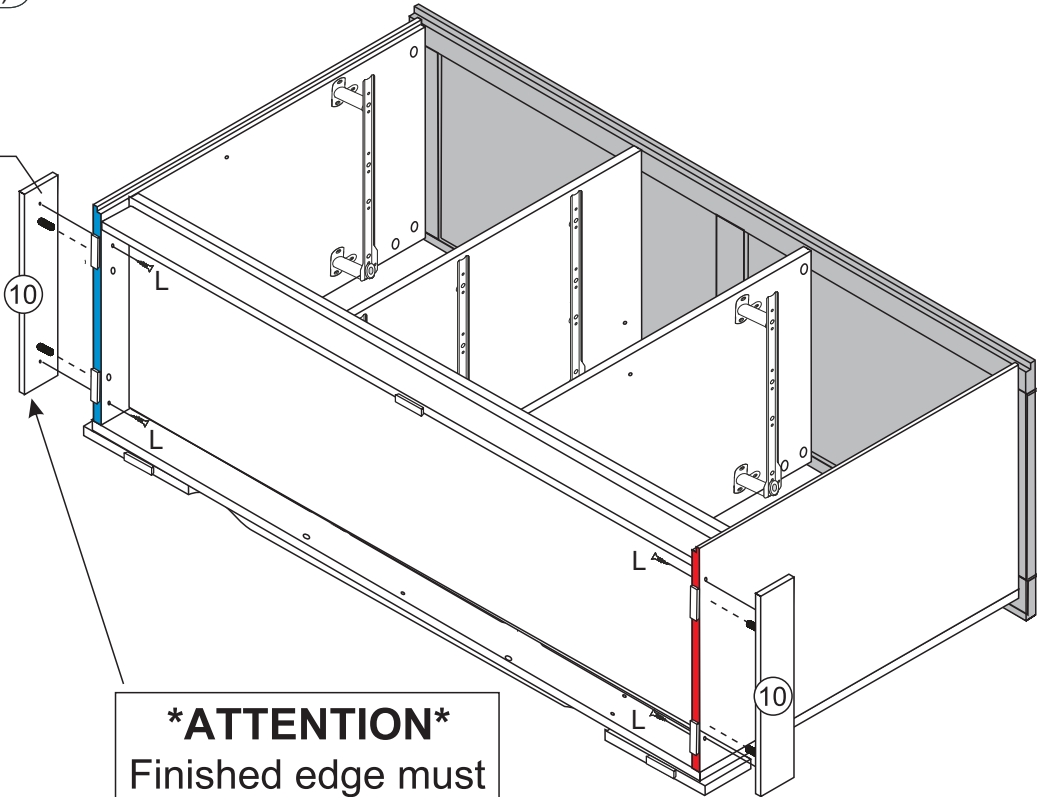

Detail 11

**\*ATTENTION\***  
Finished edge must  
be facing up

8

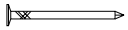

N-Nail 10 x 10mm  
(60x)

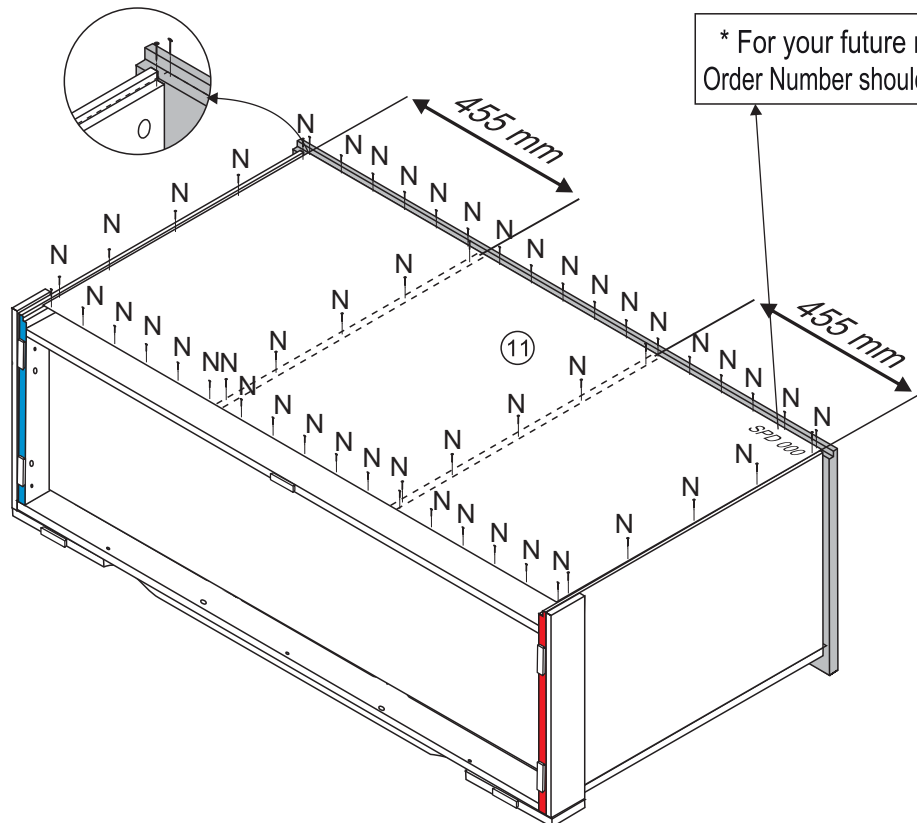

\* For your future reference  
Order Number should be here

9

H-Black Handle With Bolt (2x)

T-Black Hinge (4x)

S-Black Head Screw 3,5 x 14 (12x)

M-Flat Head Screw Ø3 x 14mm (4x)

P-Roller Catch (2x)

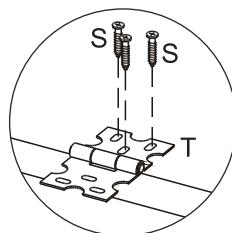
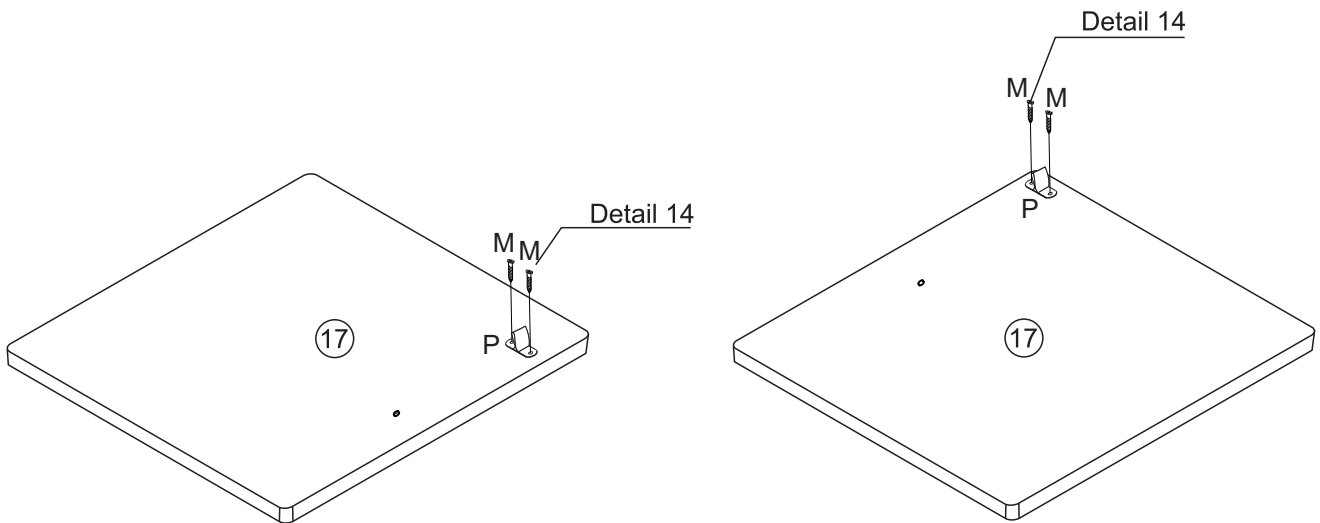
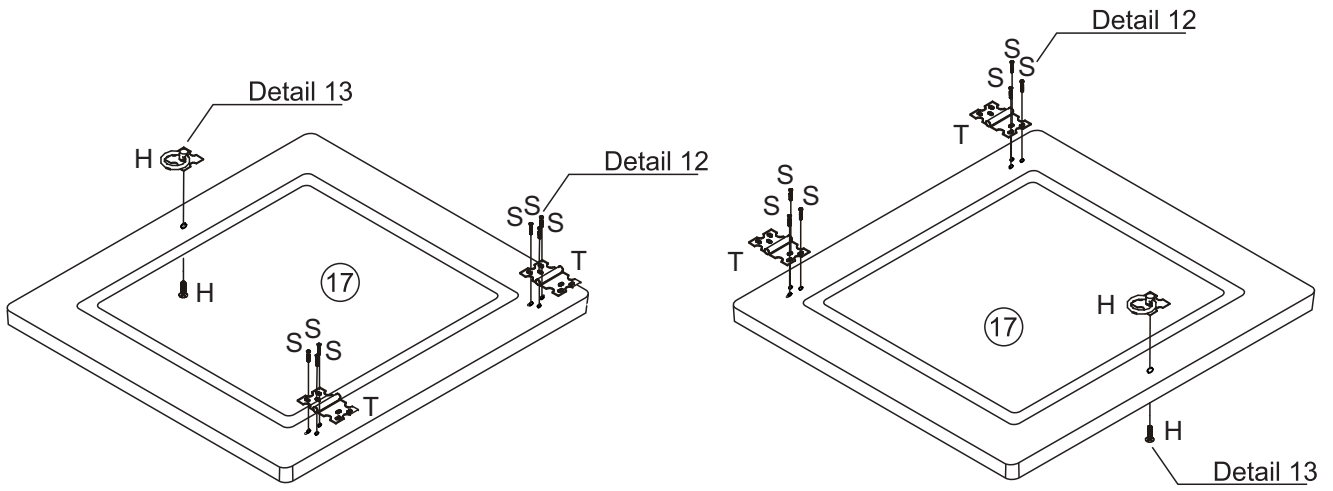

Detail 12

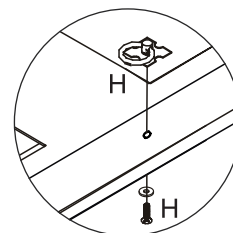

Detail 13

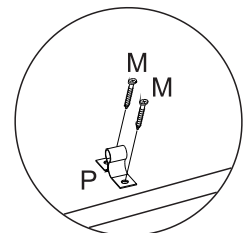

Detail 14

10

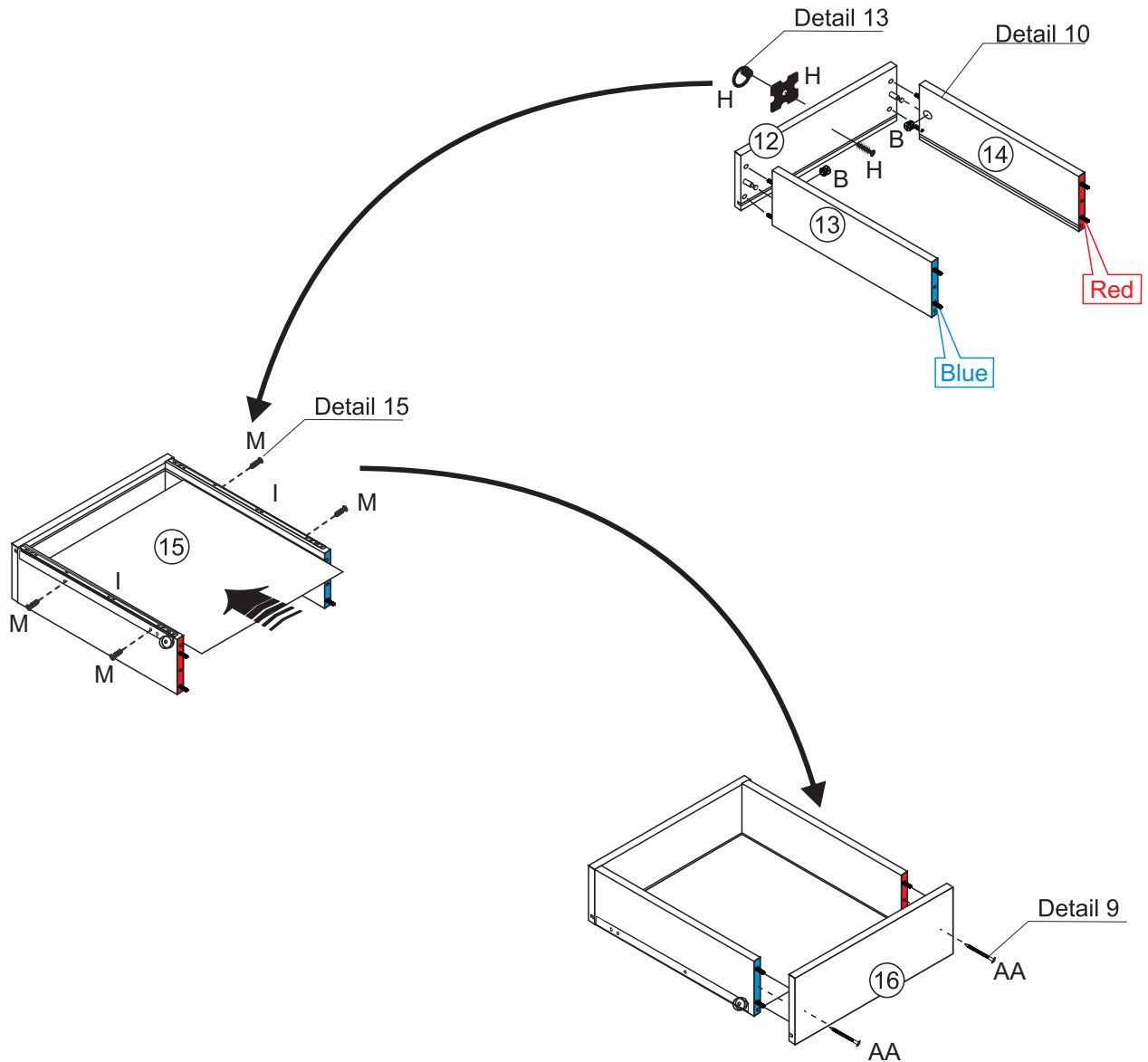
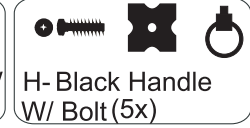
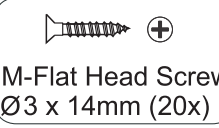
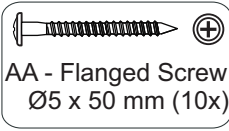
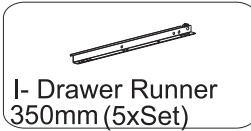
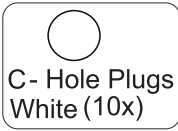

**\*REPEAT THE SAME STEPS FOR ALL DRAWERS**

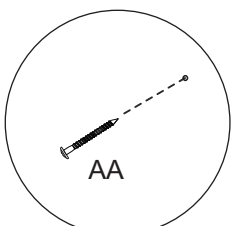

Detail 9

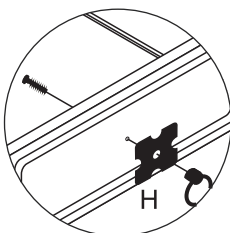

Detail 13

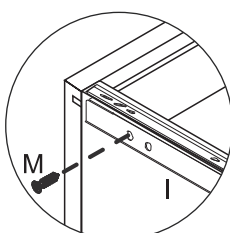

Detail 15

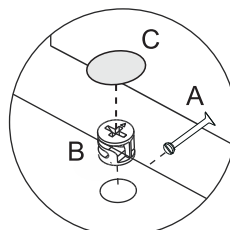

Detail 10

Fit and turn the cam clockwise

11

M-Flat Head Screw  
Ø3 x 14mm (4x)

P-Roller Catch  
(2x)

R-Shelf  
Support (8x)

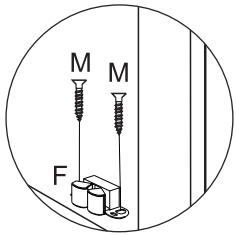
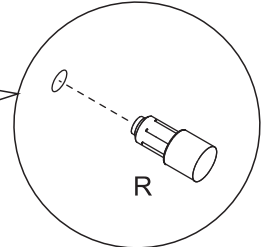
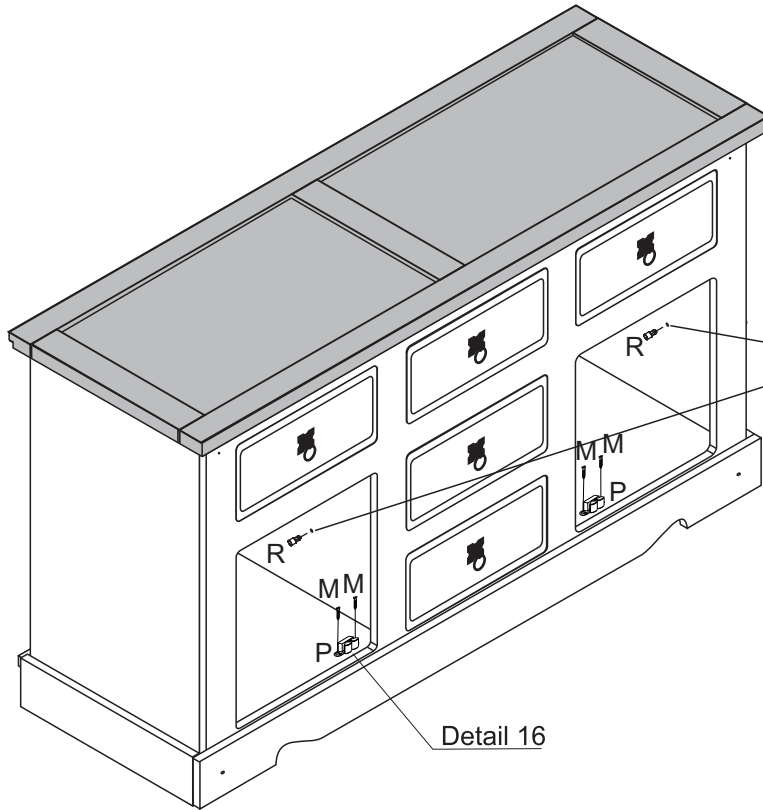

Detail 16

Detail 16

12

Q-Black Stud  
(4x)

S- Black Head Screw  
3 x 14 (12x)

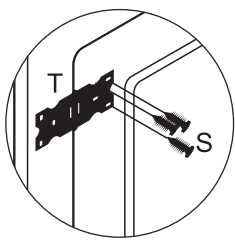
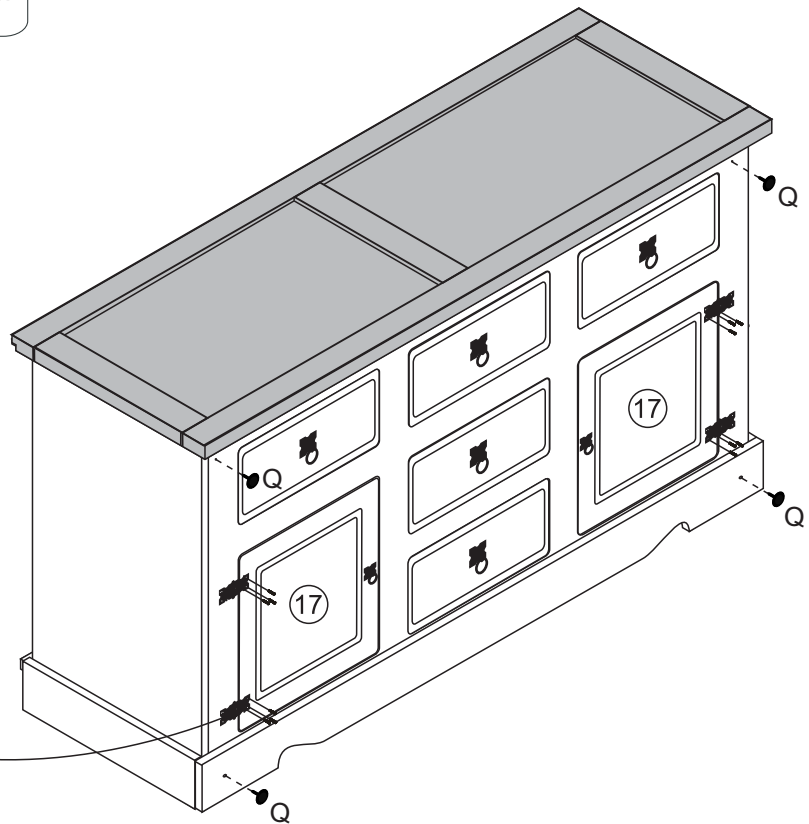

## WARNING

**Serious or fatal injuries can occur from furniture tipping over. To prevent the furniture from tipping over we recommend that it is permanently fixed to the wall.**

Wall fixings are not supplied with this product as different wall materials require different types of fixing devices.

Please make sure you use fixings suitable for the walls in your home.

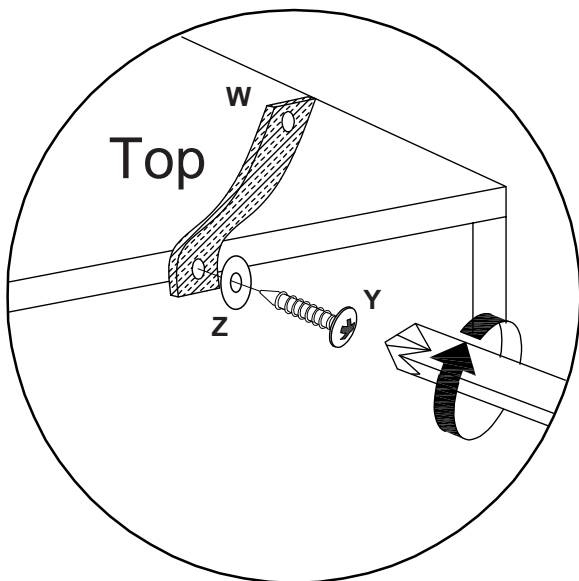

### HARDWARE LIST

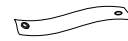

**W- Strap (Anti-Tip Kit)**  
(1x)



**Y- Wood Screw (Anti-Tip Kit)**  
3,5 x 30mm (1x)



**Z-Washer (Anti-Tip Kit)**  
(2x)

